

DORMER  PRAMET

TORNITURA

2021 – 2022

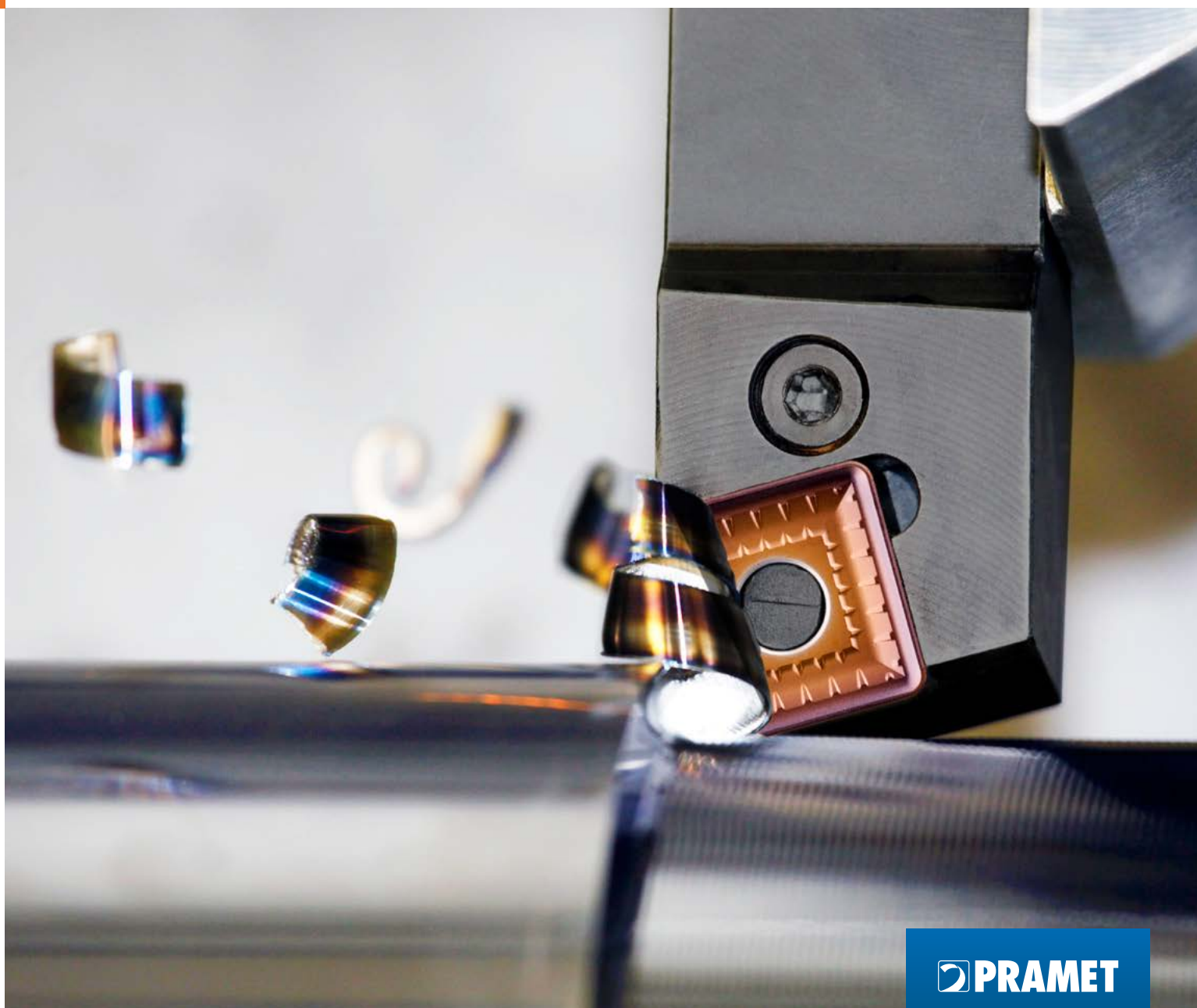



TORNITURA – CONTENUTO GENERALE

6	TORNITURA ISO	WMG & ISO 13399
10		ISTRUZIONI
18		NAVIGATORE
57		INSERTI POSITIVI
219		INSERTI NEGATIVI
386		TRONCATURA E SCANALATURA
482		FILETTATURA
528		STOZZATURA
536		INFORMAZIONI TECNICHE GENERALI



FAMIGLIA DI PRODOTTI			FAMIGLIA DI PRODOTTI			FAMIGLIA DI PRODOTTI			FAMIGLIA DI PRODOTTI		
C			DTGN(RL) EXT		346	PCLN(RL) EXT		247	SEUP(RL) INT		113
C.-DCLN(RL) EXT	249		DU, D		415, 441, 460, 467	PCLN(RL) INT		255	SEXP(RL) INT		114
C.-DCLN(RL) INT	257		DVJN(RL) EXT		360	PDJN(RL) EXT		274	SEXP(RL)-E INT		115
C.-DDJN(RL) EXT	277		DVPN(RL) EXT		361	PDNN(RL) EXT		275	SI(RL)		479, 524
C.-DDNN EXT	278		DVUN(RL) INT		364	PDUN(RL) INT		281	SI(RL)-S		526
C.-DDUN(RL) EXT	279		DWLN(RL) EXT		377	PDXN(RL) EXT		276	SRDC(RL) EXT		126
C.-DDUN(RL) INT	282		DWLN(RL) INT		382	PHZ		533	SRDCN EXT		127
C.-DRSN(RL) EXT	297		G			PHZ-2		534	SRSC(RL) EXT		128
C.-DSDNN EXT	324		GFI(RL) EXT		437	PLBN(RL) EXT		290	SSBC(RL) EXT		139
C.-DSKN(RL) EXT	325		GFIL-L AXIAL		422, 444	PRDCN EXT		124	SSDCN EXT		140
C.-DSRN(RL) EXT	326		GFIL-R AXIAL		423, 445	PRSC(RL) EXT		125	SSKC(RL) EXT		141
C.-DSSN(RL) EXT	327		GFIR-L AXIAL		424, 446	PRSN(RL) EXT		296	SSSC(RL) INT		144
C.-DTFN(RL) INT	354		GFIR-R AXIAL		425, 447	PSBN(RL) EXT		318	STFC(RL) EXT		155
C.-DTJN(RL) EXT	351		GFIR-R AXIAL		425, 447	PSDNN EXT		320	STFC(RL) INT		158
C.-DVJN(RL) EXT	363		GFK(RL) EXT		455	PSKN(RL) EXT		321	STFC(RL)-A EXT		156
C.-DWLN(RL) EXT	381		GFM(RL) EXT		439	PSKN(RL) INT		331	STFC(RL)-E INT		160
C.-DWLN(RL) INT	385		GFML-L AXIAL		426, 448	PSSN(RL) EXT		323	STJC(RL) EXT		157
C.-SCLC(RL) EXT	75		GFML-R AXIAL		427, 449	PTFN(RL) EXT		348	SVAC(RL)-DC EXT		193
C.-SCLC(RL) INT	81		GFMR-L AXIAL		428, 450	PTFN(RL) INT		353	SVGC(RL) EXT		194
C.-SDJC(RL) EXT	96		GFMR-R AXIAL		429, 450	PTGN(RL) EXT		349	SVHB(C)(RL) EXT		172, 195
C.-SDNCN EXT	97		GG.(RL) INT		421	PTTN(RL) EXT		350	SVJB(C)(RL) EXT		173, 196
C.-SDUC(RL) INT	102		GGI(RL)-90 AXIAL		430, 452	PWLN(RL) EXT		380	SVJB(RL) INT		180, 204
C.-SRDCN EXT	130		GLS B		414	PWLN(RL) INT		383	SVJC(RL)-DC EXT		197
C.-SVHB(RL) EXT	177, 201		GLSF(RL) EXT		410	S			SVLC(RL) INT		205
C.-SVJB(RL) EXT	178, 202		GLSF(RL) EXT-G		412	SCAC(RL) EXT		70	SVPB(C)(RL) EXT		174, 198
C.-SVQB(RL) INT	183, 210		GLSF(RL) EXT-S		413	SCBC(RL) EXT		71	SVQB(C)(RL) INT		181, 206
C.-SVVBN EXT	179, 203		K			SCDCR EXT		72	SVUB(C)(RL) INT		182, 207
CKJN(RL) EXT	287		KHP-CBN(RL)		251	SCFC(RL) EXT		73	SVVB(C)N EXT		175, 199
D			KHP-CLN(RL)		252	SCFC(RL) INT		76	SVXC(C)(RL) EXT		176, 200
DCBN(RL) EXT	240		KHP-LBN(RL)		291	SCKC(RL) INT		77	SVXC(RL) INT		208
DCKN(RL) EXT	242		KHP-RSC(RL)		131	SCLC(RL) EXT		74	SVXC(RL)-E INT		209
DCLN(RL) EXT	243		KHP-SBN(RL)		328	SCLC(RL) INT		78	SWLC(RL) EXT		215
DCLN(RL) INT	254		KHP-SSN(RL)		329	SCXC(RL) INT		80	SWLC(RL) INT		216
DDJN(RL) EXT	273		KHS-SBC(RL)		142	SDJC(RL) EXT		94	SWUC(RL) INT		217
DDUN(RL) INT	280		M			SDNCN EXT		95	SWUC(RL)-E INT		218
DKH(RL)		132, 143, 253, 292, 330	MS-EN		443, 463	SDQC(RL) INT		98	X		
DRSN(RL) EXT		295	MTJN(RL) EXT		347	SDUC(RL) INT		99	XLCCN 25 BS		442
DSBN(RL) EXT		313	MVJN(RL) EXT		362	SDUC(RL)-E INT		100	XLCCN B		440
DSDNN EXT		315	MWLN(RL) EXT		379	SDZC(RL) INT		101	XLCF(NRL) BS		461
DSKN(RL) EXT		316	P			SE(RL)		478, 522	XLCF(RL)		465
DSSN(RL) EXT		317	P61(RL) EXT		470	SE(RL)-S		523	XLCFN B		459
DTFN(RL) EXT		345	P61(RL) INT		471	SEGC(RL) EXT		107	XLCFN B LFUX		466
DTFN(RL) INT		352	P61S(RL)-1 INT		474	SELP(RL) INT		111	XLXFL BS AXIAL		462
			PCBN(RL) EXT		245	SELP(RL)-E INT		112			
			PCKN(RL) EXT		246	SEUC(RL) INT		108			



FAMIGLIA DI PRODOTTI		FAMIGLIA DI PRODOTTI		FAMIGLIA DI PRODOTTI		FAMIGLIA DI PRODOTTI	
C		KNUX	284	SPGN CER	147	TN ZZ INT	477
CCGT	60	L		SPMR	146	TNGA CBN	344
CCGW CBN	69	LCMF 13 – CM	418	SPUN	146	TNGA CER	343
CCMT	62	LCMF 13 – F	418	T		TNGN CER	344
CCMW	68	LCMF 13 – MP	419	TCGT	149	TNMA	334
CNGA CBN	239	LCMF 16 – CM	431	TCGW CBN	154	TNMG	335
CNGA CER	238	LCMF 16 – M	433	TCMT	150	TNMM	342
CNGG	222	LCMF 16, LCMF 30 – F	432	TCMW	154	TPGN CER	164
CNGN CER	238	LCMF 16, LCMF 30 – MP	433	TN 55° PP EXT	508	TPGX	162
CNMA	222	LCMF 20 – F1	453	TN 55° PP INT	509	TPMR	163
CNMG	223	LCMF 20 – M2	453	TN 60° PP EXT	499	TPUN	164
CNMM	234	LCMF 20 – MP	454	TN 60° PP INT	500	V	
CPGX	83	LCMR 13 – F	419	TN 60°-S PP EXT	501	VBGW CBN	171
D		LCMR 13 – MP	420	TN 60°-S PP INT	501	VBMT	168
DCGT	86	LCMR 16 – CM	434	TN ACME EXT	515	VBGT	186
DCGW CBN	92	LCMR 16 – M	435	TN ACME INT	516	VCGW	189
DCMT	87	LCMR 16 – MP	436	TN API RD EXT	519	VCGX	189
DCMW	92	LCMR 16, LCMR 30 – F	435	TN API RD INT	519	VCMT	190
DCMW PCD	93	LFMX – F1	456	TN BSPT EXT	510	VCMW	191
DNGA CBN	272	LFMX – F2	456	TN BSPT INT	510	VCMW PCD	192
DNGA CER	271	LFMX – M2	457	TN M EXT	495	VNGA CBN	359
DNGN CER	271	LFUX	464	TN M INT	497	VNGA CER	359
DNMA	260	LNUX 40, LN.X 50	289	TN MJ EXT	499	VNMG	356
DNMG	260	R		TN NPT EXT	511	W	
DNMM	270	RCGT	118	TN NPT INT	512	WCGT	212
E		RCGX CER	123	TN R EXT	475	WCGX	213
ECGT	104	RCMT	118	TN R INT	475	WCMT	213
ECMT	105	RCMW	120	TN RD EXT	520	WNGA CBN	376
ECMW	106	RCMX	121	TN RD INT	520	WNMA	366
EPGX	110	RNGN CER	294	TN STACME EXT	517	WNMG	366
EPMT	110	RNMG	294	TN STACME INT	518	WNMM	375
G		S		TN TR EXT	512	X	
GL. D – GM	406	SCGT	134	TN TR INT	513	X 61	468
GL. D – MM	406	SCMT	135	TN TR-S EXT	514	X 61 R	469
GL. D – PM	407	SCMW	138	TN TR-S INT	514	X 61 R-1	473
GL. D – PR	408	SNGA CER	311	TN UN EXT	502	X 61-1	472
H		SNGN CER	312	TN UN INT	503		
HZ	531	SNMA	300	TN UNJ EXT	504		
HZ-2	532	SNMG	301	TN W EXT	505		
K		SNMM	307	TN W INT	506		
		SNMX	311	TN ZZ EXT	476		



DORMER PRAMET



RICERCA VELOCE

Esecuzione semplice e rapida della ricerca di testo tramite la nostra app Library all'interno di qualsiasi pubblicazione lanciata da Dormer Pramet nell'ultimo periodo. Scaricatela oggi stesso dal vostro app store. **Semplicemente affidabili.**



 Download on the
App Store

 GET IT ON
Google Play

 Download on
AppGallery



TORNITURA – CONTENUTO GENERALE

6		WMG & ISO 13399
10	TORNITURA ISO	ISTRUZIONI
18		NAVIGATORE
57		INSERTI POSITIVI
219		INSERTI NEGATIVI
386		TRONCATURA E SCANALATURA
482		FILETTATURA
528		STOZZATURA
536		INFORMAZIONI TECNICHE GENERALI



GRUPPO DEI MATERIALI LAVORATI (WMG)

ISO Per selezionare qualità e geometria di taglio per una vasta gamma di materiali lavorati

Definizione generale
per es. acciaio, acciaio inox...

P **M** **K** **N** **S** **H**

Sottogruppo Per navigare e selezionare l'utensile più adatto per una più specifica gamma di materiali lavorati

Definizione in funzione della struttura/composizione
per es. acciaio al carbonio, acciaio legato...

P **M** **K** **N** **S** **H**

P1

P2

P3

P4

WMG Per selezionare e fornire condizioni di taglio con un margine di $\pm 10\%$

Definizione in funzione della durezza/massima resistenza a trazione
per es. $160 < 220\text{HB}$, $620 < 900 \text{ n/mm}^2$...

P

P1

P1.1

P1.2

P1.3

P2

P2.1

P2.2

P2.3

P3

P3.1

P3.2

P3.3

P4

P4.1

P4.2

P4.3

CLASSIFICAZIONE DEI MATERIALI LAVORATI SECONDO DORMER PRAMET

La classificazione dei materiali da lavorare (WMG) permette una scelta semplice ed affidabile del corretto utensile da taglio e dei valori di partenza adatti in condizioni di lavoro particolari.

Dormer Pramet classifica i materiali da lavorare in sei gruppi di differenti colori:

- **Blu:** acciaio e acciaio fuso (gruppo P)
- **Giallo:** acciaio inox (gruppo M)
- **Rosso:** ghisa (gruppo K)
- **Verde:** metalli non ferrosi (gruppo N)
- **Marrone:** leghe ad alta temperatura (gruppo S)
- **Grigio:** materiali temprati (gruppo H)

Ognuno di questi gruppi è suddiviso in sottogruppi sulla base della loro struttura e/o composizione. Ad esempio, il gruppo P, dell'acciaio e acciaio fuso, è diviso in quattro sottogruppi, vale a dire;

- **P1 – Acciaio a buona lavorabilità**
- **P2 – Acciaio al carbonio non legato**
- **P3 – Acciaio legato**
- **P4 – Acciaio per utensili**

Un'ultima divisione viene fatta secondo le proprietà dei materiali, come la durezza e la massima resistenza a trazione. Questo per fornire ai nostri clienti una raccomandazione completa dell'utensile, compresi i valori iniziali per velocità di taglio ed avanzamento.

La tabella nella pagina successiva include una descrizione di ciascun gruppo di materiali lavorati, nonché alcuni esempi di denominazione comunemente usata.



WMG (GRUPPI DEI MATERIALI LAVORATI)

Gruppo ISO	WMG (Gruppi dei materiali lavorati)	Duret� (HB ou HRC)	R�sistance � la traction max. (MPa)	Exemples		
P	P1	P1.1	Solfurizzato	< 240 HB	≤ 830	
		P1.2	Acciaio ad alta velocit� (acciaio al carbonio con aumentata lavorabilit�)	Solfurizzato e fosfatizzato	< 180 HB	≤ 620
		P1.3		Solfurizzato e fosfatizzato con piombo	< 180 HB	≤ 620
	P2	P2.1	Acciaio al carbonio (acciaio composto principalmente da ferro e carbonio)	Contenuto < 0.25 % C	< 180 HB	≤ 620
		P2.2		Contenuto < 0.55 % C	< 240 HB	≤ 830
		P2.3		Contenuto > 0.55 % C	< 300 HB	≤ 1030
	P3	P3.1	Acciaio legato (acciaio al carbonio con contenuto di legante ≤ 10%)	Ricotto	< 180 HB	≤ 620
		P3.2		Indurito e temprato	180 – 260 HB	> 620 ≤ 900
		P3.3			260 – 360 HB	> 900 ≤ 1240
	P4	P4.1	Acciaio per utensili (acciaio non trattabile al cromo)	Ricotto	< 26 HRC	≤ 900
P4.2		Indurito e temprato		26 – 39 HRC	> 900 ≤ 1240	
P4.3				39 – 45 HRC	> 1240 ≤ 1450	
M	M1	Acciaio inox ferritico (leghe al cromo non temprabili)		< 160 HB	≤ 520	
				160 – 220 HB	> 520 ≤ 700	
	M2	Acciaio inox martensitico (acciaio al cromo da bonifica)	Ricotto	< 200 HB	≤ 670	
			Temprato e rinvenuto	200 – 280 HB	> 670 ≤ 950	
			Trattato per precipitazione	280 – 380 HB	> 950 ≤ 1300	
	M3	Acciaio inox austenitico (leghe al cromo nickel e al cromo nickel manganese)		< 200 HB	≤ 750	
				200 – 260 HB	> 750 ≤ 870	
				260 – 300 HB	> 870 ≤ 1040	
	M4	M4.1	Acciaio inox, austenitico-ferritico (DUPLEX) o super-austenitico		< 300 HB	≤ 990
		M4.2	Acciaio inox austenitico, indurito per precipitazione		300 – 380 HB	≤ 1320
K	K1	Ghisa grigia (ASTM A48) o ghisa grigia per automotive (ASTM A159) (ghisa fusa con microstruttura a grafite lamellare)	Ferritica o ferritica-perlitica	< 180 HB	≤ 190	
			Ferritica-perlitica o perlitica	180 – 240 HB	> 190 ≤ 310	
			Perlitica	240 – 280 HB	> 310 ≤ 390	
	K2	Ghisa malleabile (ASTM A602) (ghisa fusa con microstruttura a grafite libera)	Ferritica	< 160 HB	≤ 400	
			Ferritica o perlitica	160 – 200 HB	> 400 ≤ 550	
			Perlitica	200 – 240 HB	> 550 ≤ 660	
	K3	Ghisa malleabile (ASTM A536) (ghisa fusa con microstruttura a grafite nodulare)	Ferritica	< 180 HB	≤ 560	
			Ferritica o perlitica	180 – 220 HB	> 560 ≤ 680	
			Perlitica	220 – 260 HB	> 680 ≤ 800	
	K4	K4.1	Ghisa Grigia Austenitica (ASTM A436) (leghe di ghisa fusa con microstruttura a grafite lamellare austenitica)		< 180 HB	≤ 190
		K4.2	Ghisa malleabile austenitica (ASTM A439 or ASTM A571) (leghe di ghisa fusa con microstruttura a grafite nodulare austenitica)		< 240 HB	≤ 740
					< 280 HB	> 840 ≤ 980
					280 – 320 HB	> 980 ≤ 1130
	K4.3	Ghisa sferoidale austemperata (ASTM A897) (leghe di ghisa fusa con microstruttura ausferritica)		320 – 360 HB	> 1130 ≤ 1280	
K5	Ghise a grafite compattata CGI (ASTM A842) (ghisa fusa con struttura a grafite vermiculare)	Ferritica	< 180 HB	≤ 400		
		Ferritica-perlitica	180 – 220 HB	> 400 ≤ 450		
		Perlitica	220 – 260 HB	> 450 ≤ 500		
N	N1	Semilavorato commerciale in puro alluminio		< 60 HB	≤ 240	
				60 – 100 HB	> 240 ≤ 400	
				100 – 150 HB	> 400 ≤ 590	
	N2	Leghe di alluminio pressofuso	Temprato	< 75 HB	≤ 240	
				75 – 90 HB	> 240 ≤ 270	
				90 – 140 HB	> 270 ≤ 440	
	N3	Leghe di rame con eccellente lavorabilit�		–	–	
				–	–	
				–	–	
	N4	Leghe di rame a truciolo corto con lavorabilit� buona o moderata		–	–	
				–	–	
				–	–	
	N5	Rame elettrolitico e leghe di rame a truciolo lungo con lavorabilit� da moderata a scarsa		–	–	
				–	–	
				–	–	
S	S1	Titanio o leghe di titanio		< 200 HB	≤ 660	
				200 – 280 HB	> 660 ≤ 950	
				280 – 360 HB	> 950 ≤ 1200	
	S2	Leghe resistenti al calore a base Fe		< 200 HB	≤ 690	
				200 – 280 HB	> 690 ≤ 970	
	S3	Leghe resistenti al calore a base Ni		< 280 HB	≤ 940	
				280 – 360 HB	> 940 ≤ 1200	
	S4	Leghe resistenti al calore a base Co		< 240 HB	≤ 800	
				240 – 320 HB	> 800 ≤ 1070	
	H	H1	Ghisa fusa in conchiglia		< 440 HB	–
				< 55 HRC	–	
H2		Ghisa temprata		> 55 HRC	–	
				< 51 HRC	–	
H3		Acciaio trattato < 55 HRC		51 – 55 HRC	–	
				55 – 59 HRC	–	
H4		Acciaio trattato > 55 HRC		> 59 HRC	–	
				–	–	

Esempi di materiali da lavorazione – vedere capitolo INFORMAZIONI TECNICHE GENERALI (pagina 539).



GRANDEZZE DEGLI UTENSILI DA TAGLIO SECONDO ISO 13399

Tutti gli utensili da taglio sono definiti da una serie di parametri secondo lo standard ISO 13399. Questo elenco contiene tutti i parametri utilizzati in questo catalogo e le loro definizioni.

ISO 13399 è uno standard informativo internazionale sugli utensili da taglio. Fornisce dimensioni e parametri in un formato neutro indipendente da qualsiasi particolare sistema o nomenclatura aziendale. Quando gli utensili da taglio vengono chiaramente definiti secondo uno standard globale, tutti i tipi di software possono elaborare i dati elettronici più rapidamente, migliorando la qualità della comunicazione e contribuendo a rendere ineccepibile lo scambio di informazioni. Il supporto di un linguaggio comune nelle descrizioni dei nostri utensili da taglio favorirà la comunicazione da sistema a sistema. Vi farà risparmiare una notevole quantità di tempo, fornendo una raccolta più pratica di dati di elevata qualità per tutti i nostri 40.000 utensili integrali e indicizzati. Utilizzando un sistema conforme alla norma ISO 13399, non sarà necessario interpretare manualmente i dati e inserirli da tastiera nel vostro sistema.

SOLO ESEMPI!

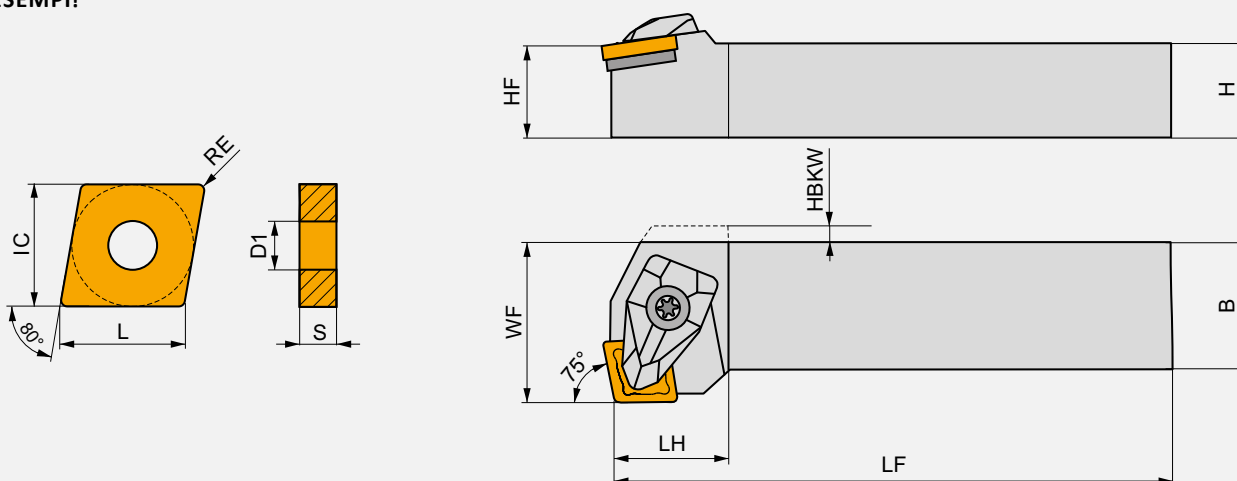

ISO 13399	Descrizione
APMX	Profondità di taglio massima
B	Larghezza stelo
BD	Diametro corpo
BLRAD	Raggio di rinforzo lama
BW	Larghezza corpo inserto
CDX	Profondità di taglio massima
CND	Diametro ingresso refrigerante
CUTDIA	Diametro massimo di troncatura del pezzo da lavorare
CW	Larghezza di taglio
CWTOLL	Tolleranza inferiore della larghezza di taglio
CWTOLU	Tolleranza superiore della larghezza di taglio
D1	Diametro foro di fissaggio
DAXIN	Diametro interno minimo della scanalatura frontale
DAXN	Diametro esterno minimo della scanalatura frontale
DAXX	Diametro esterno massimo della scanalatura frontale
DCON MS	Diametro attacco
DMIN	Diametro del foro minimo
DMINP	Diametro del foro minimo perpendicolare
GAMO	Angolo di spoglia superiore ortogonale
GAMP	Angolo di spoglia assiale
H	Altezza stelo
HBH	Altezza offset fondo testa
HBKW	Larghezza offset fondo testa
HF	Altezza funzionale
IC	Diametro del cerchio inscritto
INSD	Diametro inserto
INSL	Lunghezza inserto

ISO 13399	Descrizione
KAPR	Angolo del tagliente utensile
L	Lunghezza del tagliente
LAMS	Angolo di inclinazione
LB	Lunghezza corpo
LF	Lunghezza funzionale
LFA	Dimensione A su LF
LFS	Lunghezza funzionale secondaria
LH	Lunghezza testa
LU	Lunghezza utile
M	Dimensione M
OAL	Lunghezza complessiva
PDX	Distanza profilo X
PDY	Distanza profilo Y
PSIRL	Angolo del tagliente principale di sinistra
PSIRR	Angolo del tagliente principale di destra
RE	Raggio di punta
S	Spessore inserto
S1	Spessore inserto totale
TP	Passo del filetto
TPI	Filetti per pollice
TPIN	Filetti per pollice
TPIX	Filetti per pollice
TPN	Passo del filetto minimo
TPX	Passo del filetto massimo
W1	Larghezza inserto
WF	Larghezza funzionale
WFS	Larghezza funzionale secondaria



DORMER PRAMET



TUTTI GLI UTENSILI INSIEME

Il nostro intero assortimento di utensili integrali e a fissaggio meccanico è incluso nell'app per il calcolo dei parametri. Sono più di 40.000 articoli! Qualunque sia la vostra lavorazione, sicuramente sull'app ci sarà.

Semplicemente affidabili.

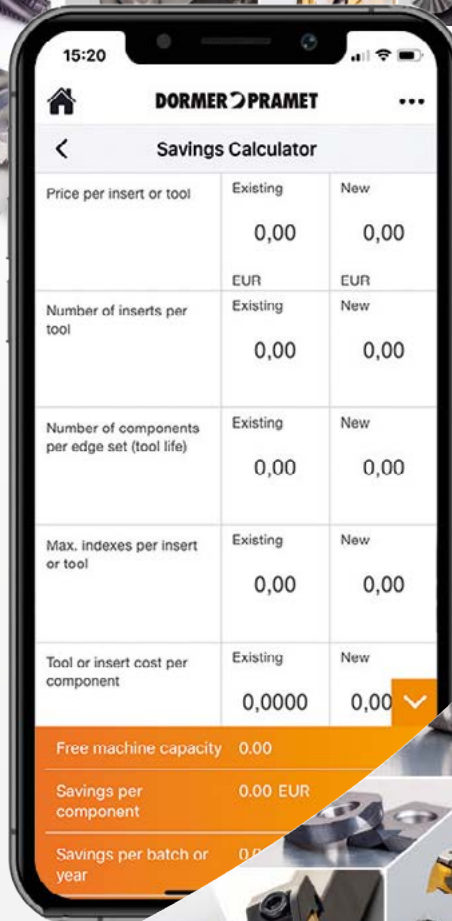

	Existing	New
Price per insert or tool	0,00	0,00
	EUR	EUR
Number of inserts per tool	0,00	0,00
Number of components per edge set (tool life)	0,00	0,00
Max. indexes per insert or tool	0,00	0,00
Tool or insert cost per component	0,0000	0,00

Free machine capacity 0,00

Savings per component 0.00 EUR

Savings per batch or year 0,00

TORNITURA ISO





TORNITURA – CONTENUTO GENERALE

6		WMG & ISO 13399
10	TORNITURA ISO	ISTRUZIONI
18		NAVIGATORE
57		INSERTI POSITIVI
219		INSERTI NEGATIVI
386		TRONCATURA E SCANALATURA
482		FILETTATURA
526		STOZZATURA
533		INFORMAZIONI TECNICHE



INSERTI DI TORNITURA – PANORAMICA DELLA PAGINA



1 CNMM

	IC [mm]	D1 [mm]	L [mm]	S [mm]
1204	12.700	5.16	12.90	4.76
1606	15.875	6.35	16.10	6.35
1906	19.050	7.94	19.30	6.35
2509	25.400	9.12	25.80	9.53

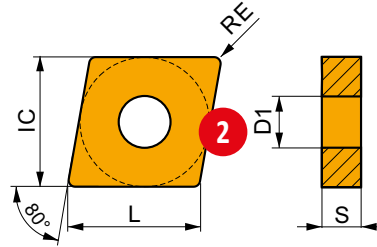

Idoneità e valori iniziali per velocità di taglio (Vc), avanzamento (f) e profondità di taglio (ap). Fare riferimento alla nostra App Machining Calculator per ulteriori calcoli.

Product	RE [mm]	P			M			K			N			S			H		
		vc	f	ap	vc	f	ap	vc	f	ap	vc	f	ap	vc	f	ap	vc	f	ap
		[m/min]	[mm/rev]	[mm]	[m/min]	[mm/rev]	[mm]	[m/min]	[mm/rev]	[mm]	[m/min]	[mm/rev]	[mm]	[m/min]	[mm/rev]	[mm]	[m/min]	[mm/rev]	[mm]

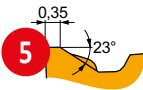

10 DR geometria per operazioni da semi sgrossatura fino a sgrossatura, da taglio continuo a interrotto.

CNMM 160612E-DR	T9315	1.2	225	0.45	6.0	—	—	—	210	0.45	6.0	—	—	—	—	—	—	—	—
	T8345	1.2	200	0.45	6.0	120	0.41	6.0	190	0.45	6.0	—	—	—	—	—	—	—	—
	T9335	1.2	170	0.45	6.0	100	0.41	6.0	—	—	—	—	—	—	—	—	—	—	—
CNMM 190608E-DR	T9315	0.8	215	0.40	8.0	—	—	—	200	0.40	8.0	—	—	—	—	—	—	—	—
	T9325	0.8	190	0.40	8.0	110	0.36	8.0	180	0.40	8.0	—	—	—	—	—	—	—	—
CNMM 190612E-DR	T9315	1.2	220	0.45	8.0	—	—	—	205	0.45	8.0	—	—	—	—	—	—	—	—
	T9325	1.2	195	0.45	8.0	115	0.41	8.0	185	0.45	8.0	—	—	—	—	—	—	—	—
	T9335	1.2	170	0.45	8.0	100	0.41	8.0	—	—	—	—	—	—	—	—	—	—	—
CNMM 190616E-DR	T9325	1.6	195	0.50	9.0	115	0.45	9.0	185	0.50	9.0	—	—	—	—	—	—	—	—
	T9335	1.6	170	0.50	9.0	100	0.45	9.0	—	—	—	—	—	—	—	—	—	—	—

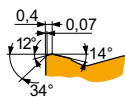

HR geometria per operazioni da sgrossatura fino a sgrossatura pesante, taglio continuo e interrotto.

CNMM 190616E-HR	6640	1.6	75	0.60	10.0	45	0.54	10.0	70	0.60	10.0	—	—	—	—	—	—	—	—
	T8345	1.6	55	0.60	10.0	30	0.54	10.0	50	0.60	10.0	—	—	—	—	—	—	—	—
	T9325	1.6	105	0.60	10.0	60	0.54	10.0	95	0.60	10.0	—	—	—	—	—	—	—	—
	T9335	1.6	80	0.60	10.0	45	0.54	10.0	—	—	—	—	—	—	—	—	—	—	—

CNMM190616E-HR:T8345

Al momento dell'ordine utilizzare il codice di specifica dell'inserto completo!

Qualità

Due punti inclusi

Codice inserto ISO



INSERTI DI TORNITURA – PANORAMICA DELLA PAGINA

Pos.	Descrizione	Pos.	Descrizione
1	Designazione dell'inserto	7	Codice inserto ISO
2	Disegno schematico dell'inserto	8	Qualità
3	Tabella con dimensioni inserto (mm)	9	Raggi dell'inserto (mm)
4	Figura dell'inserto rappresentativo	10	Descrizione geometria
5	Profilo del rompitruciolo	11	Campo di applicazione dell'inserto
6	Icone - caratteristiche specifiche e tipo di tagliente		



UTENSILI DI TORNITURA – PANORAMICA DELLA PAGINA

1 DDUN(RL) INT

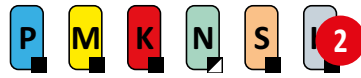

5

Utensile interno, doppio bloccaggio, per inserto DN... angolo del tagliente utensile 93°
Bareno destro/sinistro per tornitura interna con doppio bloccaggio a staffa e passaggio refrigerante interno, angolo del tagliente utensile 93° per inserti negativi DN...11 e 15. Diametro interno minimo tornibile Ø32 mm. Adatto per un'ampia gamma di operazioni di tornitura e copiatura fino a 27°. Disponibile con stelo da Ø25 mm a Ø50 mm. Corpo trattato per una maggiore durata.

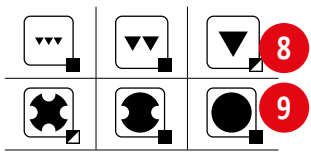
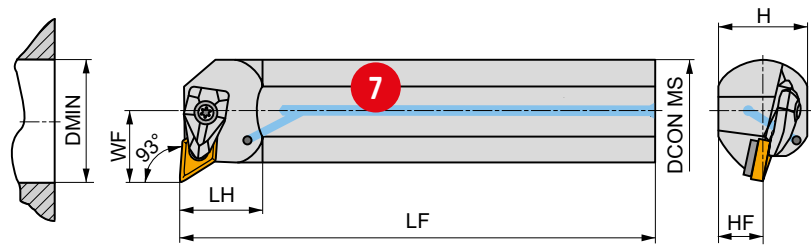
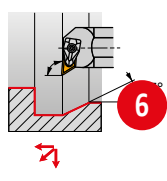

Product	DCON MS [mm]	DMIN [mm]	WF [mm]	H [mm]	HF [mm]	LF [mm]	LH [mm]	LAMS [°]	GAMO [°]					
R A25T-DDUNR 11	25	32	17	23	11.5	300	28	-12	-6	✓	0.96	GI046	DD11	-
A32T-DDUNR 11	32	40	22	30	15	300	30	-10	-6	✓	1.68	GI046	DD11	-
A40T-DDUNR 15	40	50	27	37	18.5	300	36	-11	-6	✓	2.59	GI044	DD154	AT002
A50U-DDUNR 15	50	63	35	47	23.5	350	39	-8	-6	✓	5.25	GI044	DD154	AT002
L A25T-DDUNL 11	25	32	17	23	11.5	300	28	-12	-6	✓	0.96	GI046	DD11	-
A32T-DDUNL 11	32	40	22	30	15	300	30	-10	-6	✓	1.69	GI046	DD11	-
A40T-DDUNL 15	40	50	27	37	18.5	300	36	-11	-6	✓	2.59	GI044	DD154	AT002
A50U-DDUNL 15	50	63	35	47	23.5	350	39	-8	-6	✓	5.25	GI044	DD154	AT002

	19	
GI044		DN.. 1506..
GI046		DN.. 1104..

			20			
DD11	DCS 09	1.7		DDS 267-01	US 2004-T09P	FLAG T09P
DD154	DCS 12	3.9		DDS 266-02	US 2002-T15P	FLAG T15P/3,5

		21		
AT002a	DN.. 1504..		-	DDS 266-01
AT002b	CER DN.N 1506..		DCS 12C4	-
AT002c	CER DN.A 1506..		DCS 12C2	-



UTENSILI DI TORNITURA – PANORAMICA DELLA PAGINA

Pos.	Descrizione	Pos.	Descrizione
1	Designazione dell'utensile di tornitura	12	Codice ISO dell'utensile
2	Raccomandazioni sul gruppo di materiali	13	Dimensioni [mm] e angoli ²⁾ [°] dell'utensile
3	Sistema di bloccaggio dell'inserto	14	Alimentazione interna del refrigerante
4	Figura illustrativa ¹⁾	15	Peso [kg]
5	Descrizione dell'utensile	16	Gruppo di inserti compatibili ³⁾
6	Profilo del pezzo da lavorare	17	Gruppo di parti di ricambio ^{3),4)}
7	Disegno schematico dell'utensile	18	Gruppo di accessori ^{3),4)}
8	Idoneità al tipo di lavorazione	19	Inserti compatibili
9	Idoneità delle condizioni di taglio/lavorazione	20	Parti di ricambio
10	Applicazioni del prodotto	21	Accessori
11	Verso di taglio dell'utensile		

¹⁾ Gli utensili di tornitura sono di solito rappresentati nella versione destra (R)

²⁾ GAMO = Angolo di spoglia superiore ortogonale (vedere parte tecnica)
LAMS = Angolo di inclinazione del tagliente principale (vedere parte tecnica)

³⁾ Codice gruppo di inserti compatibili, parti di ricambio e accessori speciali sono impiegati solo per esigenze di catalogo e non sono codici validi per ordinazioni.

⁴⁾ Icone di parti di ricambio e di speciali accessori sono rappresentate schematicamente per una facile comprensione. Non sono quindi incluse nella lista di icone. Le viti sono, in alcuni casi, completate con informazioni del momento torcente in Nm, lunghezza e dimensioni del passo.



UTENSILI DI TORNITURA – PANORAMICA DELLE ICONE

ICONE GENERALI

	Utilizzo primario		Finitura – ottima qualità superficiale		Adatto a condizioni di lavorazione stabili
	Utilizzo possibile		Lavorazione media – buona qualità superficiale		Adatto a condizioni di lavorazione instabili
			Sgrossatura – rugosità superficiale illimitata		Adatto a condizioni di lavorazione molto instabili

CARATTERISTICHE

	Prima scelta		Inserto con geometria raschiante		Tagliante affilato
	Per materiali che producono truciolo corto		Sbalzo ampio		Tagliante arrotondato
	Per materiali tenaci (truciolo lungo)		Lavorazione di ruote ferroviarie		Tagliante con smusso
	Condizioni di lavoro gravose		Pezzi da lavorare sottili e con pareti sottili		Tagliante arrotondato con smusso
	Taglio ad alta velocità di avanzamento		Ampia gamma di opzioni universali		Tagliante con doppio smusso
	Velocità di taglio elevata				Tagliante arrotondato con doppio smusso





















OPERAZIONI DI TORNITURA

	Tornitura conica – esterna		Cianfrinatura (smussatura)		Lavorazione della faccia posteriore (spallamento) dal retro
	Tornitura conica – interna		Cianfrinatura (smussatura) dal retro		Copiatura di tornitura multidirezionale – esterna
	Copiatura di tornitura (lavorazione multidirezionale)		Cianfrinatura (smussatura) nel foro		Copiatura di tornitura multidirezionale – interna
	Copiatura di tornitura in piano		Tornitura longitudinale con spallamento – esterna		Copiatura di tornitura monodirezionale – esterna
	Copiatura di tornitura in piano nel foro		Tornitura longitudinale con spallamento – interna		Copiatura di tornitura monodirezionale – interna
	Tornitura in piano con spallamento		Tornitura longitudinale senza spallamento – esterna		Scanalatura radiale superficiale
	Tornitura in piano senza spallamento		Tornitura longitudinale senza spallamento – interna		





UTENSILI DI TORNITURA – PANORAMICA DELLE ICONE

PAGINE TECNICHE

	Super finitura		Avanzamento [mm/rev]		Velocità di taglio molto elevata, eccellente rigidità di sistema (condizioni di lavoro stabili)
	Finitura		Durata [min]		Elevata velocità di taglio, alta rigidità di sistema (condizioni di lavoro stabili)
	Lavorazione media		Qualità		Velocità di taglio alta, rigidità leggermente limitata (profondità di taglio variabile)
	Sgrossatura		Rivestimento		Velocità di taglio media, rigidità limitata (taglio leggermente interrotto)
	Sgrossatura pesante		Velocità di taglio		Velocità di taglio ridotta, bassa rigidità di sistema (taglio interrotto)
	Fattore di moltiplicazione per la velocità di taglio		Profilo del tagliente		Velocità di taglio molto bassa, rigidità precaria (condizioni di lavoro instabili)
	Profondità di taglio [mm]		Refrigerante		

ALTRO

	Coppia di bloccaggio della vite [Nm]		Teste modulari per sgrossatura		Alimentazione interna del refrigerante
---	--------------------------------------	---	--------------------------------	---	--



INSERTI ISO POSITIVI – NAVIGATORE

CCGT



 60

CCMT



 62

CCMW



 68

CCGW CBN



 69

DCGT



 86

DCMT



 87

DCMW



 92

DCGW CBN



 92

DCMW PCD



 93

ECGT



 104

ECMT



 105

ECMW



 106

EPGX



 110

EPMT



 110

RCGT



 118

RCMT



 118

RCMW



 120

RCMX



 121

RCGX CER



 123

SCGT



 134

SCMT



 135

SCMW



 138

SPMR



 146

SPUN



 146

SPGN CER



 147

TCGT



 149

TCMT



 150

TCMW



 154



TCGW CBN



 154



INSERTI ISO POSITIVI – NAVIGATORE

TPGX  162	TPMR  163	TPUN  164	TPGN CER  164	
VBMT  168	VBGW CBN  171	VCGT  186	VCGW  189	VCGX  189
VCMT  190	VCMW  191	VCMW PCD  192		
WCGT  212	WCGX  213	WCMT  213		

CNGG



 222

CNMA



 222

CNMG



 223

CNMM



 234

CNGA CER



 238

CNGN CER



 238

CNGA CBN



 239

DNMA



 260

DNMG



 260

DNMM



 270

DNGA CER



 271

DNGN CER



 271

DNGA CBN



 272

KNUX



 284

LNUX 40, LN.X 50

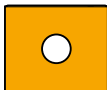

 289

RNMG



 294

RNGN CER



 294

SNMA



📖 300

SNMG



📖 301

SNMM



📖 307

SNMX



📖 311

SNGA CER



📖 311

SNGN CER

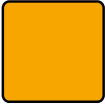

📖 312

TNMA



📖 334

TNMG



📖 335

TNMM



📖 342

TNGA CER



📖 343

TNGN CER



📖 344

TNGA CBN



📖 344

VNMG



📖 356

VNGA CER



📖 359

VNGA CBN



📖 359

WNMA



📖 366

WNMG



📖 366

WNMM



📖 375

WNGA CBN



📖 376



INSERTI ISO POSITIVI – NAVIGATORE ROMPIRUCIOLO

P

Condizioni molto instabili

Condizioni instabili

Condizioni stabili

Pezzo in lavorazione con pareti sottili

1^a scelta

Utilizzo possibile

RF

SR

FF2

FM2

RM3

OR

FF

UR

FM

RM

DR4

SF3



	0.05 – 0.2 mm/rev	0.05 – 0.2 mm/rev	0.2 – 0.4 mm/rev	0.4 – 1.0 mm/rev	> 1.0 mm/rev
	0.05 – 2 mm	0.05 – 2 mm	2 – 4 mm	4 – 10 mm	> 10 mm

UR		Progettato per lavorazioni di finitura, acciai e ghise e potenzialmente acciaio inossidabile, tagli continui e interrotti
FM		Progettato per lavorazioni da finitura a semi-sgrossatura, acciai e acciai inossidabili, potenzialmente ghise e materiali non ferrosi, tagli continui e moderatamente interrotti
RM		Progettato per lavorazioni di semi-sgrossatura, acciai, acciai inossidabili e ghise, potenzialmente superleghe e materiali temprati, tagli continui e interrotti

OR		Progettato per lavorazioni di sgrossatura e sgrossatura pesante, acciai, acciai inossidabili e ghise, potenzialmente superleghe e materiali temprati, tagli continui e interrotti
-----------	--	---



INSERTI ISO POSITIVI – NAVIGATORE ROMPIRUCIOLO

M



Condizioni molto instabili



Condizioni instabili



Condizioni stabili



Pezzo in lavorazione con pareti sottili

 1^a scelta
 Utilizzo possibile



NF1



FM2



RF



SR



OR



SF2



NF2



FM



RM



DR4



SF3



SI

0.05 – 0.2 mm/rev

0.05 – 0.2 mm/rev

0.2 – 0.4 mm/rev

0.4 – 1.0 mm/rev

> 1.0 mm/rev

0.05 – 2 mm

0.05 – 2 mm

2 – 4 mm

4 – 10 mm

> 10 mm

NF1		Design positivo per lavorazioni di finitura da fine a media, acciai inossidabili e superleghe, potenzialmente acciai, materiali non ferrosi e duri, tagli continui	OR		Progettato per lavorazioni di sgrossatura e sgrossatura pesante, acciai, acciai inossidabili e ghise, potenzialmente superleghe e materiali temprati, tagli continui e interrotti
FM		Progettato per lavorazioni da finitura a semi-sgrossatura, acciai e acciai inossidabili, potenzialmente ghise e materiali non ferrosi, tagli continui e moderatamente interrotti			
RM		Progettato per lavorazioni di semi-sgrossatura, acciai, acciai inossidabili e ghise, potenzialmente superleghe e materiali temprati, tagli continui e interrotti			

23





INSERTI ISO POSITIVI – NAVIGATORE ROMPIRUCIOLO

K

 Condizioni molto instabili

 Condizioni instabili

 Condizioni stabili

 Pezzo in lavorazione con pareti sottili

 1ª scelta

 Utilizzo possibile



RM3

.CMW

RF **RM**

SF3

SR

OR

DR4

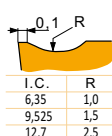
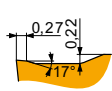
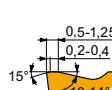

	0.05 – 0.2 mm/rev	0.05 – 0.2 mm/rev	0.2 – 0.4 mm/rev	0.4 – 1.0 mm/rev	> 1.0 mm/rev
	0.05 – 2 mm	0.05 – 2 mm	2 – 4 mm	4 – 10 mm	> 10 mm

RF		Progettato per lavorazioni di sgrossatura, ghise, potenzialmente acciai, acciai inossidabili e materiali duri, tagli continui e interrotti
RM		Progettato per lavorazioni di semi-sgrossatura, acciai, acciai inossidabili e ghise, potenzialmente superleghe e materiali temprati, tagli continui e interrotti
OR		Progettato per lavorazioni di sgrossatura e sgrossatura pesante, acciai, acciai inossidabili e ghise, potenzialmente superleghe e materiali temprati, tagli continui e interrotti



INSERTI ISO POSITIVI – NAVIGATORE ROMPIRUCIOLO

N

Condizioni molto instabili

Condizioni instabili

Condizioni stabili

Pezzo in lavorazione con pareti sottili

1^a scelta

Utilizzo possibile

NF1

FM

SF3

AL

f	0.05 – 0.2 mm/rev	0.05 – 0.2 mm/rev	0.2 – 0.4 mm/rev	0.4 – 1.0 mm/rev	> 1.0 mm/rev
a_p	0.05 – 2 mm	0.05 – 2 mm	2 – 4 mm	4 – 10 mm	> 10 mm

SF3		Design molto positivo per la lavorazione fine e di finitura, superleghe, acciai inossidabili e materiali non ferrosi, potenzialmente acciaio, ghise e materiali duri, tagli continui
AL		Design altamente positivo per finiture fini fino alla sgrossatura, alluminio, leghe di alluminio e altri materiali non ferrosi, potenzialmente superleghe, tagli continui



INSERTI ISO POSITIVI – NAVIGATORE ROMPIRUCIOLO

S

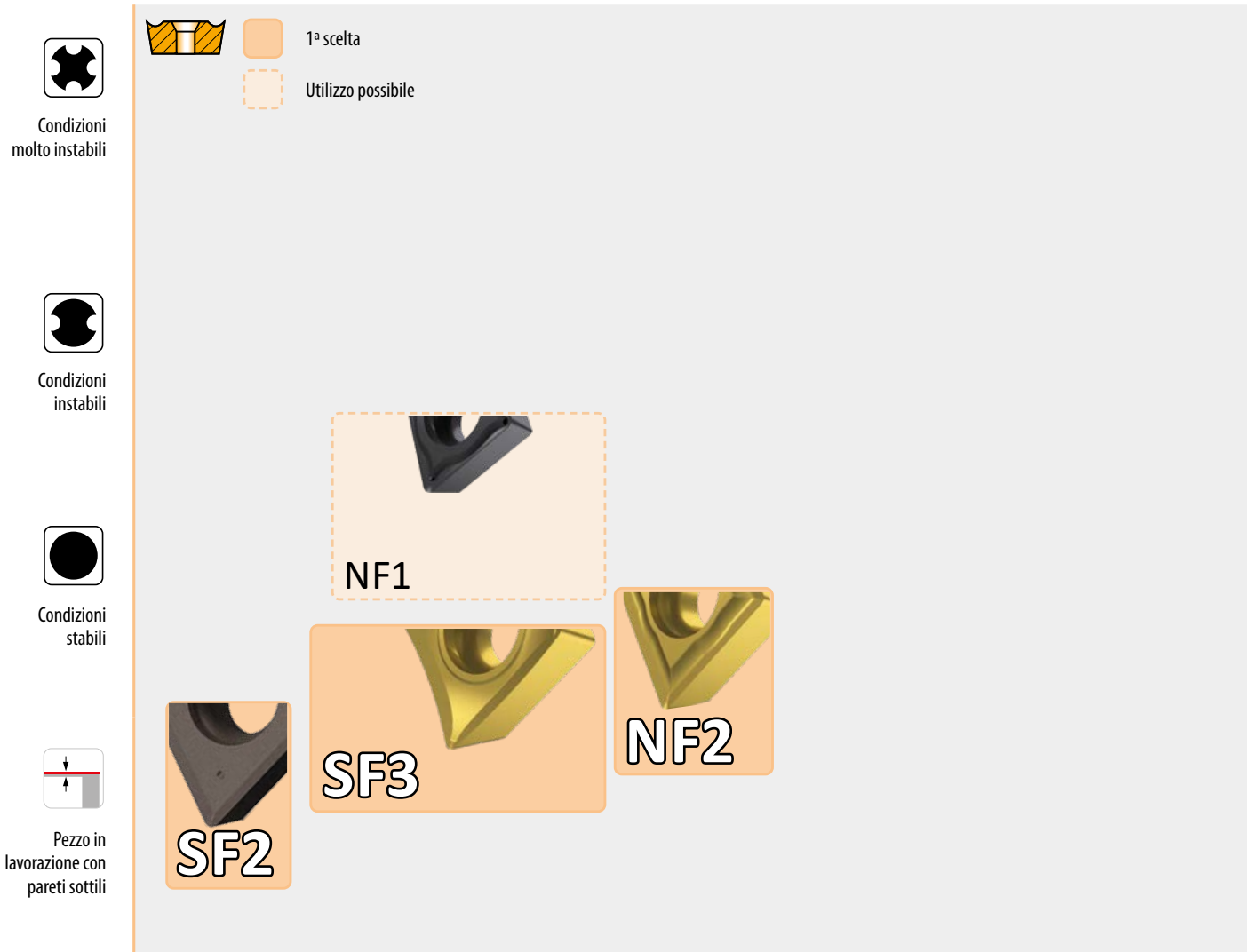





	0.05 – 0.2 mm/rev	0.05 – 0.2 mm/rev	0.2 – 0.4 mm/rev	0.4 – 1.0 mm/rev	> 1.0 mm/rev
	0.05 – 2 mm	0.05 – 2 mm	2 – 4 mm	4 – 10 mm	> 10 mm



SF2		Design molto positivo per la lavorazione fine e di finitura, superleghe, potenzialmente acciai inossidabili, acciai e materiali non ferrosi, tagli continui			
SF3		Design molto positivo per la lavorazione fine e di finitura, superleghe, acciai inossidabili e materiali non ferrosi, potenzialmente acciaio, ghise e materiali duri, tagli continui			
NF2		Design positivo per lavorazioni da finitura fino alla semi-sgrossatura, acciai inossidabili e superleghe, tagli continui			







INSERTI ISO POSITIVI – NAVIGATORE ROMPIRUCIOLO

H

 Condizioni molto instabili
 Condizioni instabili
 Condizioni stabili
 Pezzo in lavorazione con pareti sottili

 1^a scelta
 Utilizzo possibile

 **RM3**
 **NF1**  **.CMW**
 **SF3**



0.05 – 0.2 mm/rev

0.05 – 0.2 mm/rev

0.2 – 0.4 mm/rev

0.4 – 1.0 mm/rev

> 1.0 mm/rev





0.05 – 2 mm

0.05 – 2 mm

2 – 4 mm

4 – 10 mm

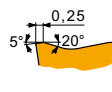
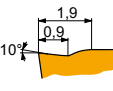
> 10 mm

SF3		Design molto positivo per la lavorazione fine e di finitura, superleghe, acciai inossidabili e materiali non ferrosi, potenzialmente acciaio, ghise e materiali duri, tagli continui	RM3		Progettato per lavorazioni di sgrossatura, ghise, potenzialmente acciai, acciai inossidabili e materiali duri, tagli continui e interrotti
NF1		Design positivo per lavorazioni di finitura da fine a media, acciai inossidabili e superleghe, potenzialmente acciai, materiali non ferrosi e duri, tagli continui			
.CMW		Progettato per lavorazioni di finitura da fine a semi-sgrossatura, ghise, potenzialmente materiali duri, tagli continui e leggermente interrotti			



INSERTI ISO NEGATIVI – NAVIGATORE ROMPIRUCIOLO

P

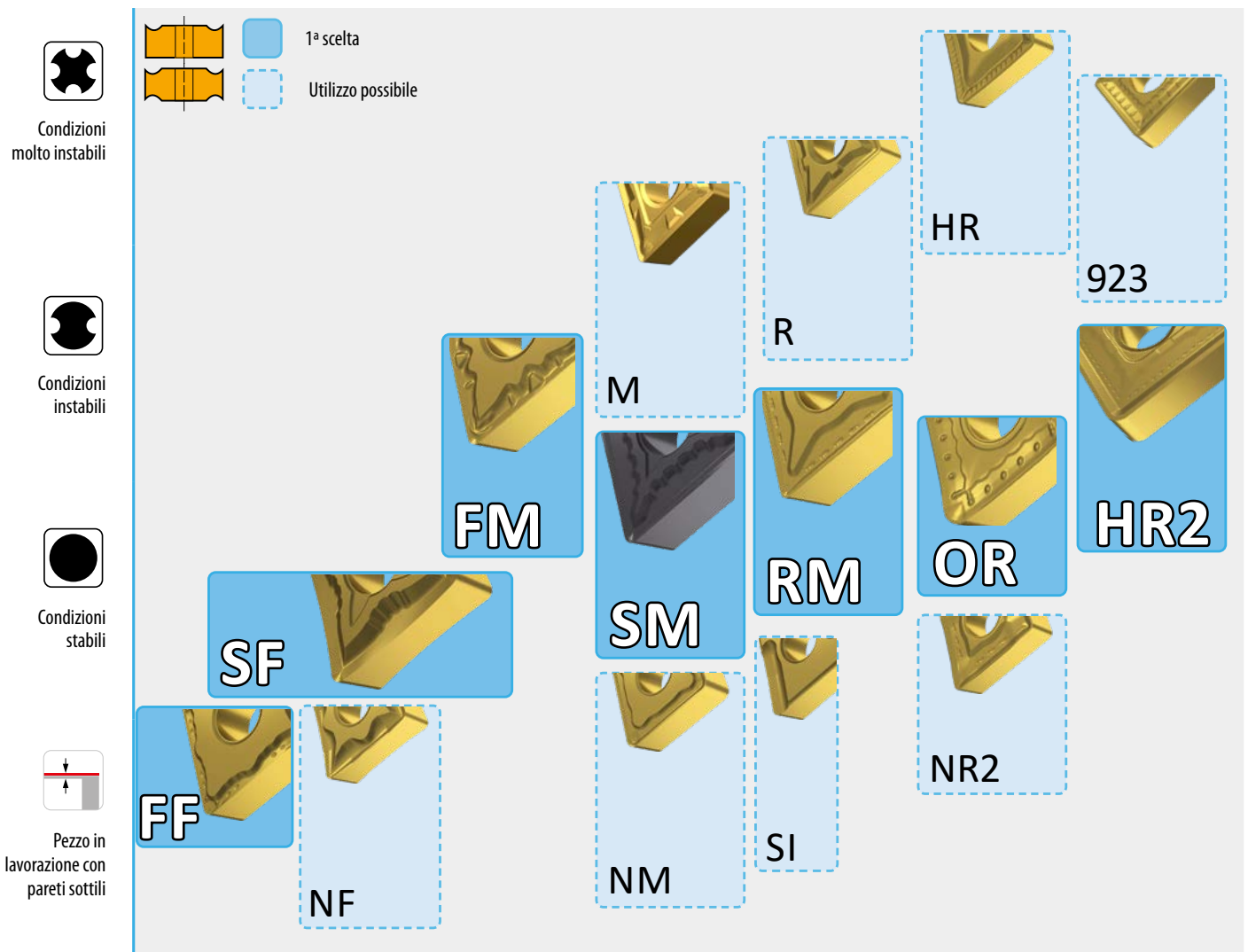

f	0.05 – 0.2 mm/rev	0.05 – 0.2 mm/rev	0.2 – 0.4 mm/rev	0.4 – 1.0 mm/rev	> 1.0 mm/rev
a_p	0.05 – 2 mm	0.05 – 2 mm	2 – 4 mm	4 – 10 mm	> 10 mm

FF		Geometria altamente positiva progettata per lavorazioni di finitura, acciaio inossidabile e acciaio, potenzialmente ghise, tagli continui
SF		Geometria positiva versatile progettata per lavorazioni di finitura, acciai, acciai inossidabili, ghise e superleghe e materiali duri, potenzialmente materiali non ferrosi e per la lavorazione di pareti sottili, con tagli continui
FM		Geometria positiva progettata per lavorazioni da finitura a semi-sgrossatura, acciai e ghise, potenzialmente e superleghe, tagli continui e moderatamente interrotti

SM		Geometria positiva progettata per lavorazioni medie, acciai inossidabili, superleghe, acciai e ghise, potenzialmente materiali non ferrosi e duri e per lavorazioni di pareti sottili, tagli continui e interrotti
RM		Progettato per lavorazioni di semi-sgrossatura e sgrossatura, acciai, acciai inossidabili e ghise, potenzialmente superleghe, tagli continui e interrotti
OR		Progettato per lavorazioni dalla finitura alla sgrossatura pesante, acciai e ghise, potenzialmente acciaio inossidabile e superleghe, tagli continui e interrotti



INSERTI ISO NEGATIVI – NAVIGATORE ROMPIRUCIOLO

M

Condizioni molto instabili

Condizioni instabili

Condizioni stabili

Pezzo in lavorazione con pareti sottili

1^a scelta
 Utilizzo possibile



0.05 – 0.2 mm/rev

0.05 – 0.2 mm/rev

0.2 – 0.4 mm/rev

0.4 – 1.0 mm/rev

> 1.0 mm/rev



0.05 – 2 mm

0.05 – 2 mm

2 – 4 mm

4 – 10 mm

> 10 mm

FF		Geometria altamente positiva progettata per lavorazioni di finitura, acciaio inossidabile e acciaio, potenzialmente ghise, tagli continui
SF		Geometria positiva versatile progettata per lavorazioni di finitura, acciai, acciai inossidabili, ghise e superleghe e materiali duri, potenzialmente materiali non ferrosi e per la lavorazione di pareti sottili, con tagli continui
NF		Design altamente positivo per finiture e lavorazioni medie, acciai inossidabili, acciaio, potenzialmente ghise, materiali non ferrosi e superleghe, tagli continui
SM		Geometria positiva progettata per lavorazioni medie, acciai inossidabili, superleghe, acciai e ghise, potenzialmente materiali non ferrosi e duri e per lavorazioni di pareti sottili, tagli continui e interrotti
NMR		Design positivo per lavorazioni medie e fino alla sgrossatura, acciai inossidabili, acciai teneri e superleghe, tagli continui
NR2		Progettato per la finitura fino alla sgrossatura, acciai inossidabili e acciai, potenzialmente ghise e superleghe, tagli continui e interrotti



INSERTI ISO NEGATIVI – NAVIGATORE ROMPIRUCIOLO

K

Condizioni molto instabili

Condizioni instabili

Condizioni stabili

Pezzo in lavorazione con pareti sottili

1ª scelta

Utilizzo possibile

.NMA

M

R

OR

923

SF

SM

KR

NR2

HR2

f	0.05 – 0.2 mm/rev	0.05 – 0.2 mm/rev	0.2 – 0.4 mm/rev	0.4 – 1.0 mm/rev	> 1.0 mm/rev
a_p	0.05 – 2 mm	0.05 – 2 mm	2 – 4 mm	4 – 10 mm	> 10 mm

.NMA		Progettato per lavorazioni da finitura a semi-sgrossatura, ghise, potenzialmente materiali duri, tagli continui e leggermente interrotti
M		Progettato per lavorazioni di finitura e semi-sgrossatura, ghise, potenzialmente acciai e materiali duri, tagli continui e interrotti
KR		Progettato per lavorazioni di semi-sgrossatura e sgrossatura, ghise, potenzialmente acciai e materiali duri, tagli continui e interrotti
OR		Progettato per lavorazioni dalla finitura alla sgrossatura pesante, acciai e ghise, potenzialmente acciaio inossidabile e superleghe, tagli continui e interrotti
HR2		Progettato per lavorazioni di sgrossatura e sgrossatura pesante con avanzamenti elevati, acciai e ghise, potenzialmente acciai inossidabili, tagli continui e interrotti



INSERTI ISO NEGATIVI – NAVIGATORE ROMPIRUCIOLO

N

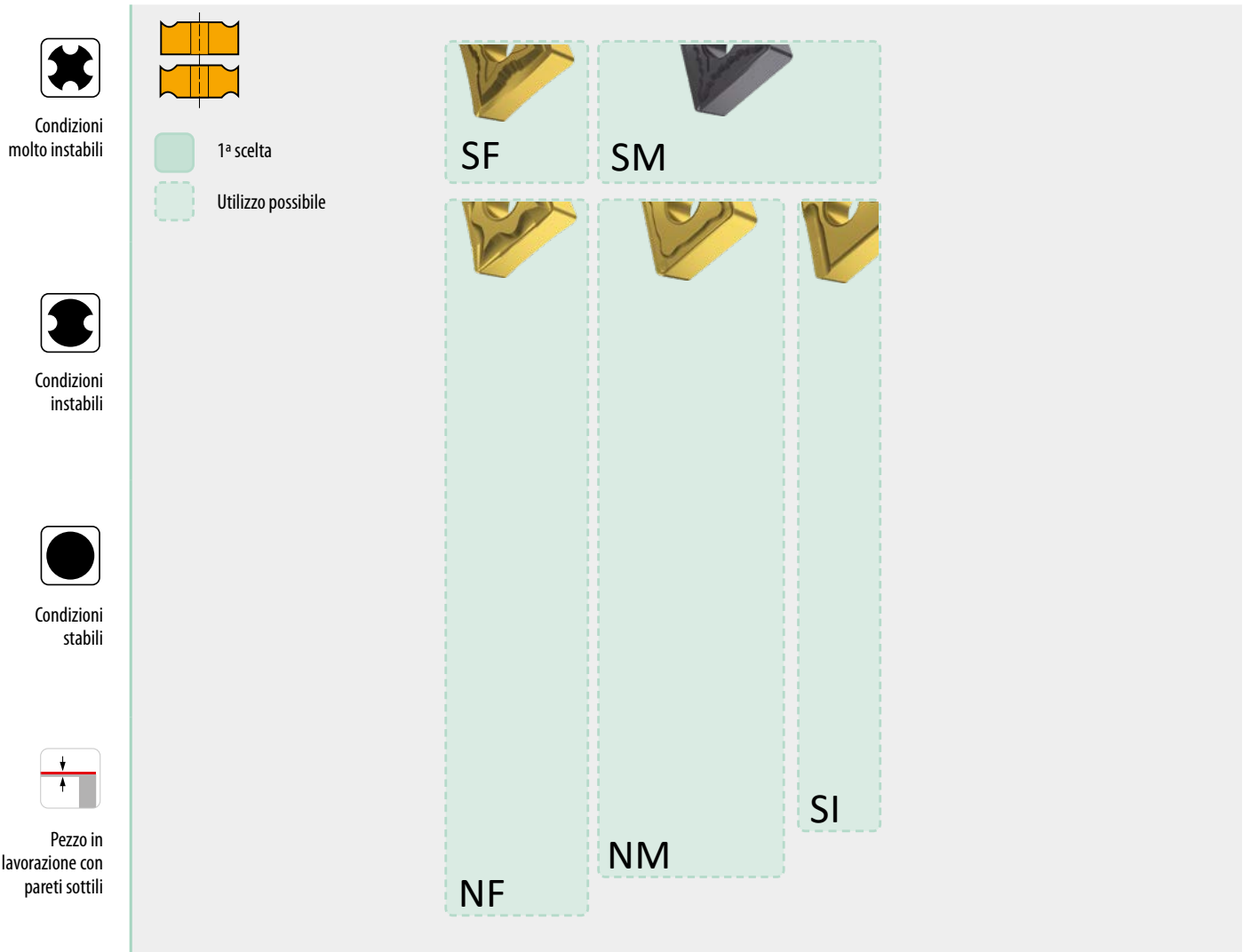

0.05 – 0.2 mm/rev

0.05 – 0.2 mm/rev

0.2 – 0.4 mm/rev

0.4 – 1.0 mm/rev

> 1.0 mm/rev





0.05 – 2 mm

0.05 – 2 mm

2 – 4 mm

4 – 10 mm

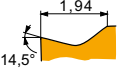
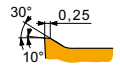
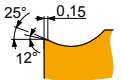
> 10 mm

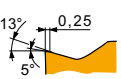
<p>SF</p> 	<p>Geometria positiva versatile progettata per lavorazioni di finitura, acciai, acciai inossidabili, ghise e superleghe e materiali duri, potenzialmente materiali non ferrosi e per la lavorazione di pareti sottili, con tagli continui</p>	<p>NM</p> 	<p>Design altamente positivo per finiture, lavorazioni medie e sgrossatura, acciai inossidabili, acciai, potenzialmente materiali non ferrosi e superleghe, tagli continui</p>
<p>NF</p> 	<p>Design altamente positivo per finiture fini e lavorazioni medie, acciai inossidabili, acciaio, potenzialmente ghise, materiali non ferrosi e superleghe, tagli continui</p>	<p>SI</p> 	<p>Geometria positiva per finiture fino a lavorazioni di semi-sgrossatura, acciai, acciai inossidabili e ghise e potenzialmente materiali non ferrosi, tagli continui</p>
<p>SM</p> 	<p>Geometria positiva progettata per lavorazioni medie, acciai inossidabili, superleghe, acciai e ghise, potenzialmente materiali non ferrosi e duri e per lavorazioni di pareti sottili, tagli continui e interrotti</p>		



INSERTI ISO NEGATIVI – NAVIGATORE ROMPIRUCIOLO

S

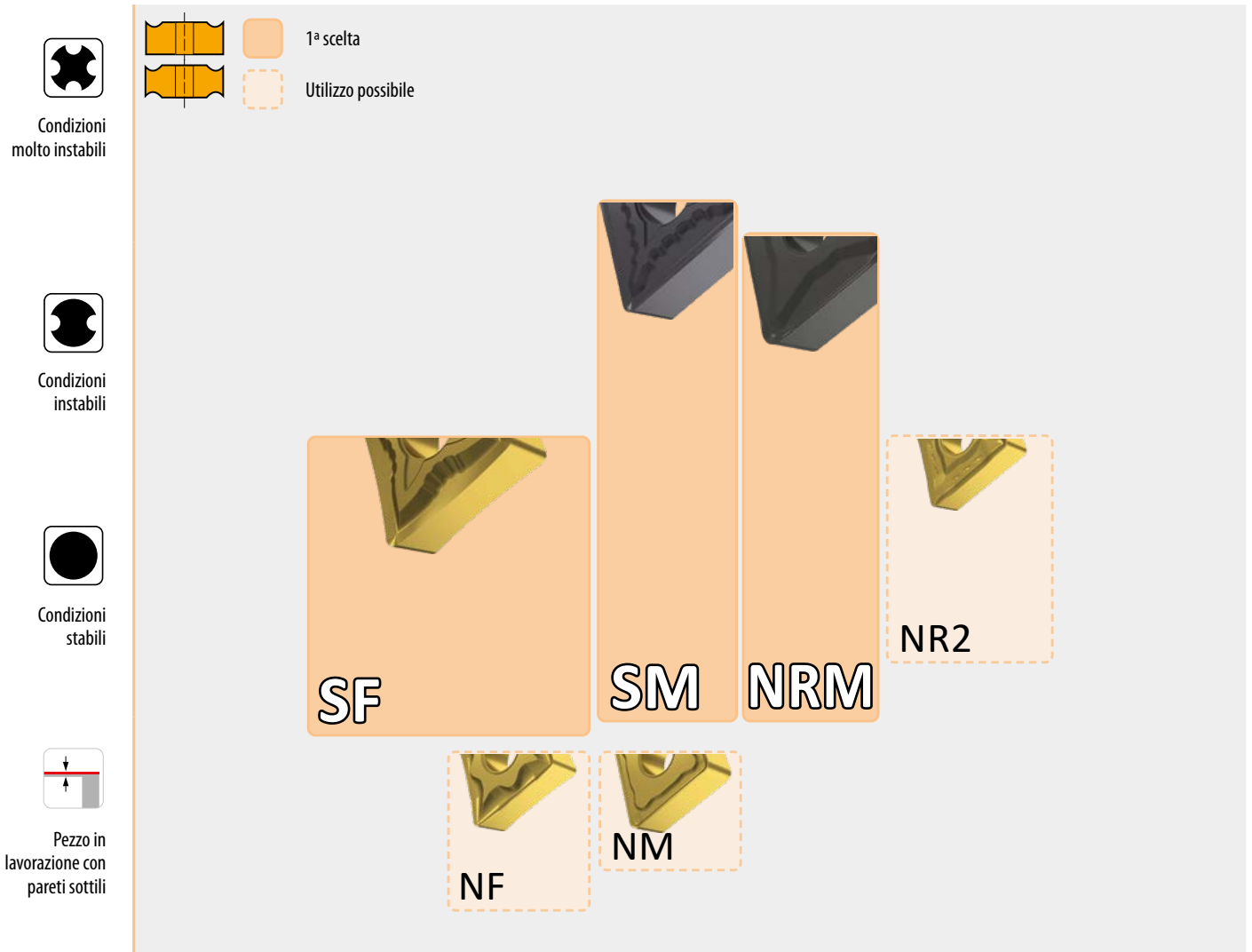

	0.05 – 0.2 mm/rev	0.05 – 0.2 mm/rev	0.2 – 0.4 mm/rev	0.4 – 1.0 mm/rev	> 1.0 mm/rev
	0.05 – 2 mm	0.05 – 2 mm	2 – 4 mm	4 – 10 mm	> 10 mm

SF		Geometria positiva versatile progettata per lavorazioni di finitura, acciai, acciai inossidabili, ghise e superleghe e materiali duri, potenzialmente materiali non ferrosi e per la lavorazione di pareti sottili, con tagli continui
SM		Geometria positiva progettata per lavorazioni medie, acciai inossidabili, superleghe, acciai e ghise, potenzialmente materiali non ferrosi e duri e per lavorazioni di pareti sottili, tagli continui e interrotti
NRM		Design positivo per lavorazioni di semi-sgrossatura e sgrossatura, acciai inossidabili, acciai dolci e superleghe, tagli continui



INSERTI ISO NEGATIVI – NAVIGATORE ROMPIRUCIOLO

H



Condizioni molto instabili

Condizioni instabili

Condizioni stabili

Pezzo in lavorazione con pareti sottili

 1ª scelta
 Utilizzo possibile



0.05 – 0.2 mm/rev

0.05 – 0.2 mm/rev

0.2 – 0.4 mm/rev

0.4 – 1.0 mm/rev

> 1.0 mm/rev





0.05 – 2 mm

0.05 – 2 mm

2 – 4 mm

4 – 10 mm

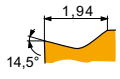
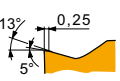
> 10 mm

SF		Geometria positiva versatile progettata per lavorazioni di finitura, acciai, acciai inossidabili, ghise e superleghe e materiali duri, potenzialmente materiali non ferrosi e per la lavorazione di pareti sottili, con tagli continui
SM		Geometria positiva progettata per lavorazioni medie, acciai inossidabili, superleghe, acciai e ghise, potenzialmente materiali non ferrosi e duri e per lavorazioni di pareti sottili, tagli continui e interrotti
.NMA		Progettato per lavorazioni di finitura da fine a semi-sgrossatura, ghise, potenzialmente materiali duri, tagli continui e leggermente interrotti

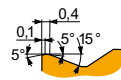
R		Progettato per lavorazioni di semi-sgrossatura e sgrossatura, ghise, potenzialmente acciai e materiali duri, tagli continui e interrotti



QUALITÀ DI TORNITURA – NAVIGATORE

Gruppo	Metallo duro con MTCVD	Metallo duro con PVD	Metallo duro	CERMET
P01				
P05	T9310			TT010
P10		T6310		
P15	T9315			TT310
P20				
P25	T9325			
P30		T8430		
P35	T9335			
P40				
P45				
P50				

Gruppo	Metallo duro con MTCVD	Metallo duro con PVD	Metallo duro	CERMET
M01				
M05				
M10		T6310		
M15				
M20	T7325			
M25		T8315		
M30	T7335			
M35		T8430		
M40				

Gruppo	Metallo duro con MTCVD	Metallo duro con PVD	Metallo duro	CERMET
K01				
K05	T5305			
K10				
K15	T5315			
K20			HF7	
K25				
K30		T8430		
K35				
K40				

Gruppo	Metallo duro con MTCVD	Metallo duro con PVD	Metallo duro	CERMET
N01				
N05				
N10				
N15		T0315		
N20			HF7	
N25				
N30				

Gruppo	Metallo duro con MTCVD	Metallo duro con PVD	Metallo duro	CERMET
S01				
S05				
S10		T6310		
S15			H07	
S20	T7325			
S25	T7335			
S30				

Gruppo	Metallo duro con MTCVD	Metallo duro con PVD	Metallo duro	CERMET
H01				
H05				
H10	T5305	T6310		
H15		T8315		
H20	T9315			
H25				
H30				



QUALITÀ DI TORNITURA – NAVIGATORE

Identificazione della qualità	Area di applicazione	Applicazione	Avanzamento	Velocità di taglio	Resistenza a condizioni di lavoro avverse	Rivestimento	Colore	Substrato	Vantaggio refrigerante	Descrizione della qualità
T9310	P01 - P15	■				MT-CVD		FGM	++	Qualità con elevata resistenza all'abrasione, utilizzabile per taglio leggermente interrotto. Sarà impiegata per operazioni di finitura e semi sgrossatura. Questo materiale può essere usato anche per operazioni di sgrossatura, a patto che la configurazione del pezzo dell'utensile sia sufficientemente rigida.
	K05 - K20	▣	▴	▴	▴					
	H10 - H20	▣								
T9315	P05 - P25	■				MT-CVD		FGM	++	Una qualità versatile con eccellenti proprietà di resistenza all'usura anche in condizioni di taglio intense. Si può utilizzare anche per operazioni con tagli interrotti. Grazie alle sue proprietà ben bilanciate, questa qualità può essere la prima scelta per un'ampia gamma di operazioni di tornitura. Non adatta a basse velocità di taglio.
	K05 - K25	▣	▴	▴	▴					
	H10 - H20	▣								
T9325	P15 - P35	■				MT-CVD		FGM	++	Dal punto di vista tecnologico, si tratta di una qualità estremamente versatile con un'elevata resistenza al danneggiamento meccanico in condizioni di taglio avverse e che conserva una resistenza all'usura eccellente. La corretta applicazione di questo materiale richiede elevate velocità di taglio.
	M10 - M30	■	▴	▴	▴					
	K15 - K35	▣								
	S10 - S20	▣								
T9335	P20 - P45	■				MT-CVD		FGM	+++	Una delle qualità più tenaci, particolarmente idonea per condizioni di taglio avverse con ritmi di avanzamento da medi a elevati e velocità di taglio medie. Rispetto ai suoi predecessori, M15 - M40 non soltanto è più tenace, ma anche più resistente all'abrasione, caratteristica utile quando si applicano condizioni di taglio intense.
	M15 - M40	■	▴	▴	▴					
	S15 - S25	▣								
T7325	P15 - P35	▣				MT-CVD		FGM	+++	Una delle qualità di tornitura più universali. Concepita appositamente per la lavorazione di acciaio inossidabile. Equilibrio ottimale tra resistenza all'usura e affidabilità operativa. Adatta per un'ampia varietà di applicazioni nelle operazioni di tornitura.
	M10 - M25	■	▴	▴	▴					
	S10 - S25	■								
T7335	P20 - P40	▣				MT-CVD		FGM	+++	Qualità con substrato a gradiente funzionale, caratterizzata da un'affidabilità operativa estremamente elevata e una resistenza all'usura molto buona. È perfetta da usare nella lavorazione di materiali molto tenaci M20 - M40.
	M20 - M40	■	▴	▴	▴					
	S15 - S25	■								
T5305	P05 - P15	▣				MT-CVD		H	+	Qualità con resistenza molto elevata all'usura chimica; idonea per operazioni di finitura con applicazione di velocità di taglio elevate. Grazie alla sua elevata resistenza all'abrasione, è idonea anche per la lavorazione produttiva K01 - K15 di materiali trattati e temprati.
	K01 - K15	■	▴	▴	▴					
	H05 - H15	▣								
T5315	P10 - P25	▣				MT-CVD		H	+	Qualità destinata principalmente alla lavorazione produttiva, con un'elevata resistenza all'abrasione e buona affidabilità operativa. Date le sue caratteristiche, questo materiale è particolarmente idoneo per operazioni di finitura e sgrossatura in presenza di condizioni di taglio buone o leggermente avverse.
	K10 - K25	■	▴	▴	▴					
	H15 - H25	▣								
6640	P20 - P40	■				MT-CVD		H	+++	Uno dei materiali di tornitura più tenaci che può essere impiegato, specialmente nelle operazioni di sgrossatura, oppure nei casi in cui l'affidabilità operativa in condizioni di taglio avverse rappresenta una priorità. Un'altra scelta ideale per macchine che operano con velocità di taglio da basse a medie e ritmi di avanzamento da medi ad alti.
	M20 - M35	■	▴	▴	▴					
	K25 - K40	■								



QUALITÀ DI TORNITURA – NAVIGATORE

Identificazione della qualità	Area di applicazione	Applicazione	Avanzamento	Velocità di taglio	Resistenza a condizioni di lavoro avverse	Rivestimento	Colore	Substrato	Vantaggio refrigerante	Descrizione della qualità
T8315	P05 - P20	<input checked="" type="checkbox"/>				PVD		submicron H	++	Qualità caratterizzata da un'eccellente resistenza all'abrasione pur mantenendo un'affidabilità operativa superiore alla media, è adatta per lavorazioni a velocità di taglio medio-alte in materiali più duri a truciolo corto.
	M05 - M20	<input checked="" type="checkbox"/>								
	K05 - K25	<input checked="" type="checkbox"/>								
	N05 - N25	<input checked="" type="checkbox"/>								
	S05 - S15	<input checked="" type="checkbox"/>								
H05 - H15	<input checked="" type="checkbox"/>									
T8430 NEW	P20 - P40	<input checked="" type="checkbox"/>				PVD		submicron H	+++	Indubbiamente, il materiale da taglio più versatile, è utile per la lavorazione di tutti i tipi di materiali lavorati ed è applicabile a quasi tutti i tipi di operazioni di tornitura. I suoi principali vantaggi sono l'elevata affidabilità operativa e caratteristiche di attrito molto buone; è pertanto idoneo per applicazioni a velocità di taglio medie e più basse.
	M20 - M35	<input checked="" type="checkbox"/>								
	K25 - K40	<input checked="" type="checkbox"/>								
	N15 - N30	<input checked="" type="checkbox"/>								
	S15 - S25	<input checked="" type="checkbox"/>								
H15 - H25	<input checked="" type="checkbox"/>									
T8330	P25 - P40	<input checked="" type="checkbox"/>				PVD		submicron H	+++	Materiale da taglio versatile, è utile per la lavorazione di tutti i tipi di materiali lavorati ed è applicabile a quasi tutti i tipi di operazioni di tornitura. I suoi principali vantaggi sono l'elevata affidabilità operativa e caratteristiche di attrito molto buone; è pertanto idoneo per applicazioni a velocità di taglio medie e più basse.
	M20 - M35	<input checked="" type="checkbox"/>								
	K20 - K40	<input checked="" type="checkbox"/>								
	N15 - N30	<input checked="" type="checkbox"/>								
	S15 - S25	<input checked="" type="checkbox"/>								
H15 - H25	<input checked="" type="checkbox"/>									
T8345	P30 - P50	<input checked="" type="checkbox"/>				PVD		submicron H	+++	È la qualità di tornitura più tenace, destinata principalmente alla lavorazione in condizioni di taglio pessime e nell'ambito di applicazioni con le più alte esigenze di affidabilità operativa. Date queste caratteristiche, questo materiale è consigliato per velocità di taglio più basse.
	M20 - M40	<input checked="" type="checkbox"/>								
	K30 - K40	<input checked="" type="checkbox"/>								
	S20 - S30	<input checked="" type="checkbox"/>								
T6310	P01 - P15	<input checked="" type="checkbox"/>				PVD		ultra submicron H	+++	Qualità di tornitura ad alta resistenza all'usura con rivestimento PVD superiore. Adatta per operazioni di finitura e applicazioni, dove il tagliente affilato insieme a un'elevata resistenza all'usura sul fianco è di grande importanza
	M01 - M15	<input checked="" type="checkbox"/>								
	K05 - K20	<input checked="" type="checkbox"/>								
	N05 - N20	<input checked="" type="checkbox"/>								
	S01 - S15	<input checked="" type="checkbox"/>								
H01 - H15	<input checked="" type="checkbox"/>									
T0315	N05 - N20	<input checked="" type="checkbox"/>				PVD		submicron H	++	Qualità submicronica per la tornitura di metalli non ferrosi e delle rispettive leghe con un equilibrio tra resistenza all'usura e tenacità. È dotata di un rivestimento esclusivo con eccellenti caratteristiche di attrito.
HF7	M10 - M20	<input checked="" type="checkbox"/>				×		submicron H	++	Qualità non rivestita, progettata principalmente per la lavorazione di metalli non ferrosi; ma può essere utilizzata anche per altri materiali lavorati (tranne l'acciaio). Questo materiale può essere impiegato per tornitura, fresatura e persino alesatura.
	K10 - K25	<input checked="" type="checkbox"/>								
	N10 - N25	<input checked="" type="checkbox"/>								
H07	M05 - M15	<input checked="" type="checkbox"/>				×		submicron H	++	Qualità di tornitura non rivestita adatta in applicazioni di lavorazione dove la resistenza all'ossidazione non è il criterio dominante della vita utensile. Concepita per la lavorazione di leghe a base di titanio. La qualità mostra un'elevata resistenza del tagliente insieme a una buona resistenza all'usura.
	K10 - K25	<input checked="" type="checkbox"/>								
	N10 - N30	<input checked="" type="checkbox"/>								
	S01 - S20	<input checked="" type="checkbox"/>								
TT310	P10 - P25	<input checked="" type="checkbox"/>				PVD		cermet	+/-	Cermet rivestito utilizzato per la tornitura di finitura e fine degli acciai a contenuto di carbonio e legati (compreso l'acciaio inossidabile). Le sue eccellenti caratteristiche di attrito sono ulteriormente migliorate dal rivestimento applicato con la tecnica PVD.
	M15 - M25	<input checked="" type="checkbox"/>								



QUALITÀ DI TORNITURA – NAVIGATORE

Identificazione della qualità	Area di applicazione	Applicazione	Avanzamento	Velocità di taglio	Resistenza a condizioni di lavoro avverse	Rivestimento	Colore	Substrato	Vantaggio refrigerante	Descrizione della qualità
TT010	P01 - P10	■				×		cermet	+ / -	Cermet non rivestito, idoneo per la lavorazione fine di tutti i tipi di acciaio (incluso l'acciaio inossidabile) a ritmi di avanzamento molto bassi. Il suo vantaggio principale è il raggio minimo del tagliente e la sua elevata resistenza ai meccanismi fisici e chimici di usura.
	M01 - M10	■								
TC100	K01 - K15	■				×		ceramics	--	Qualità ceramica per la lavorazione della ghisa. Adatta per lavorare con velocità di taglio elevata in condizioni stabili.
TB310	K01 - K10	■				×		CBN	--	Qualità CBN per la lavorazione di materiali temprati. Adatta per lavorare con velocità di taglio elevate e piccoli avanzamenti in condizioni stabili.
	S05 - S10	■								
	H01 - H10	■								
PD1	N05 - N25	■				×		PCD	-	Qualità PKD per la tornitura di metalli non ferrosi. Scelta ideale per lavorare con velocità di taglio elevate e piccoli avanzamenti in condizioni stabili.
333TN	P45 - P50	■				PVD		HSS	+++	Qualità speciale composta da substrato HSS e rivestimento PVD sottile e duro. La qualità di taglio più tenace del portafoglio. Gli inserti con questa qualità sono unici e vengono utilizzati solo in operazioni di strozzatura per scanalature di chiavette.
	M35 - M40	■								
	K35 - K40	■								

Substrato	
H	Substrato in base WC-Co
submicron H	Substrato in base WC-Co a grana fine (< 1 µm)
ultra submicron H	Substrato in base WC-Co a grana finissima (< 0,5 µm)
FGM	Substrato a gradiente funzionale
Cermet	Carburo cementato senza WC
ceramics	Ceramico
PCD	Diamante policristallino
CBN	Nitrato cubico di boro
HSS	Acciaio super rapido

Rivestimento	
MT-CVD	Rivestimento chimico a media temperatura
PVD	Rivestimento fisico a media temperatura
×	Qualità non rivestita

Benefici del liquido refrigerante	
+++	L'utilizzo del refrigerante è essenziale
++	Estremamente raccomandato
+	Raccomandato
+ / -	Facoltativo
--	Non utilizzare refrigerante
-	Refrigerante non raccomandato

TORNITURA ISO - ESTERNA
PEZZI LUNGHED ED INSTABILI (Inserti positivi)

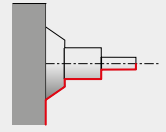

<p>SCAC(RL) EXT</p> <p>90°</p> <p>CC..</p> <p>06 09</p> <p>08x08 16x16</p> <p>70</p> <p>60-69</p>	<p>SCBC(RL) EXT</p> <p>75°</p> <p>CC..</p> <p>09 12</p> <p>12x12 25x25</p> <p>71</p> <p>60-69</p>	<p>SCDCR EXT</p> <p>45°</p> <p>CC..</p> <p>06</p> <p>10x10</p> <p>72</p> <p>60-69</p>	<p>SCFC(RL) EXT</p> <p>90°</p> <p>CC..</p> <p>06 09</p> <p>08x08 16x16</p> <p>73</p> <p>60-69</p>
<p>SCLC(RL) EXT</p> <p>95°</p> <p>CC..</p> <p>06 08 09 12</p> <p>08x08 25x25</p> <p>74</p> <p>60-69</p>	<p>SDJC(RL) EXT</p> <p>93°</p> <p>DC..</p> <p>07 11 15</p> <p>08x08 25x25</p> <p>94</p> <p>86-93</p>	<p>SDNCN EXT</p> <p>62°30'</p> <p>DC..</p> <p>7 11</p> <p>08x08 25x25</p> <p>95</p> <p>86-93</p>	<p>SEGC(RL) EXT</p> <p>90°</p> <p>EC..</p> <p>08</p> <p>12x12 16x16</p> <p>107</p> <p>104-106</p>
<p>SRDC(RL) EXT</p> <p>RC..</p> <p>08</p> <p>20x20 32x25</p> <p>126</p> <p>118-123</p>	<p>SRDCN EXT</p> <p>RC..</p> <p>06 08 10 12 16</p> <p>12x12 32x25</p> <p>127</p> <p>118-123</p>	<p>SRSC(RL) EXT</p> <p>RC..</p> <p>06 08 10 12 16</p> <p>12x12 32x25</p> <p>128</p> <p>118-123</p>	<p>SSBC(RL) EXT</p> <p>75°</p> <p>SC..</p> <p>09 12 25 38</p> <p>12x12 60x60</p> <p>139</p> <p>134-138</p>
<p>SSDCN EXT</p> <p>45°</p> <p>SC..</p> <p>09 12</p> <p>12x12 25x25</p> <p>140</p> <p>134-138</p>	<p>SSKC(RL) EXT</p> <p>75°</p> <p>SC..</p> <p>09 12</p> <p>12x12 25x25</p> <p>141</p> <p>134-138</p>	<p>STFC(RL) EXT</p> <p>90°</p> <p>TC..</p> <p>11 16</p> <p>16x16 25x25</p> <p>155</p> <p>149-154</p>	<p>STFC(RL)-A EXT</p> <p>90°</p> <p>TC..</p> <p>11</p> <p>20x20</p> <p>156</p> <p>149-154</p>

TORNITURA ISO - ESTERNA

PEZZI LUNGH ED INSTABILI (Inserti positivi)

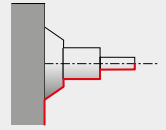

STJC(RL) EXT 93° 16×16 25×25 157 149 – 154		TC.. 11 16 193 186 – 192		SVAC(RL)-DC EXT 90° 10×10 25×25 193 186 – 192		VC.. 13 194 186 – 192		SVGC(RL) EXT 90° 08×08 16×16 194 186 – 192		VC.. 07 172, 195 168 – 171 186 – 192		SVHB(C)(RL) EXT 107°30' 16×16 25×25 172, 195 168 – 171 186 – 192		VB, VC.. 11 16 168 – 171 186 – 192	
SVJB(C)(RL) EXT 93° 12×12 32×25 173, 196 168 – 171 186 – 192		VB, VC.. 11 13 16 197 186 – 192		SVJC(RL)-DC EXT 93° 10×10 25×25 197 186 – 192		VC.. 13 174, 198 168 – 171 186 – 192		SVPB(C)(RL) EXT 117°30' 16×16 32×25 174, 198 168 – 171 186 – 192		VB, VC.. 11 16 175, 199 168 – 171 186 – 192		SVVB(C)N EXT 72°30' 12×12 32×25 175, 199 168 – 171 186 – 192		VB, VC.. 11 13 16 168 – 171 186 – 192	
SVXB(C)(RL) EXT 98° 12×12 32×25 176, 200 168 – 171 186 – 192		VB, VC.. 11 13 16 215 212 – 214		SWLC(RL) EXT 95° 16×16 25×25 215 212 – 214		WC.. 06 08 287 284 – 286		CKJN(RL) EXT 93° 20×20 32×25 287 284 – 286		KN.. 16 75 60 – 69		C.-SCLC(RL) EXT NEW 95° 20 32 75 60 – 69		CC.. 09 12 60 – 69	
C.-SDJC(RL) EXT NEW 93° C3 C5 96 86 – 93		DC.. 11 97 86 – 93		C.-SDNCN EXT NEW 62°30' C4 C5 97 86 – 93		DC.. 11 130 118 – 123		C.-SRDCN EXT NEW C4 C5 130 118 – 123		RC.. 10 12 177, 201 168 – 171 186 – 192		C.-SVHB(RL) EXT NEW 107°30' C4 C6 177, 201 168 – 171 186 – 192		VB, VC.. 16 168 – 171 186 – 192	



TORNITURA ISO - ESTERNA

PEZZI LUNGHED INSTABILI (Inserti positivi)

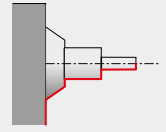

C.-SVJB(RL) EXT **NEW**

93°		VB, VC..
		11 16
	C3 C6	
	178, 202	168 – 171 186 – 192

C.-SVVBN EXT **NEW**

72°30'		VB, VC..
		16
	C4 C6	
	179, 203	168 – 171 186 – 192

TORNITURA ISO - INTERNA

COMPONENTI LUNGI E INSTABILI (inserti positivi)

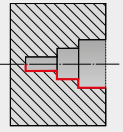

<p>SCFC(RL) INT</p> <p>90°</p> <p>CC..</p> <p>06</p> <p>$\frac{13}{16}$</p> <p>76</p> <p>60-69</p>	<p>SCKC(RL) INT</p> <p>75°</p> <p>CC..</p> <p>06 09 12</p> <p>$\frac{11}{40}$</p> <p>77</p> <p>60-69</p>	<p>SCLC(RL) INT</p> <p>95°</p> <p>CC..</p> <p>06 09 12</p> <p>$\frac{11}{40}$</p> <p>78</p> <p>60-69</p>	<p>SCXC(RL) INT</p> <p>40°</p> <p>CC..</p> <p>06</p> <p>$\frac{13}{20}$</p> <p>80</p> <p>60-69</p>
<p>SDQC(RL) INT</p> <p>107°30'</p> <p>DC..</p> <p>07 11</p> <p>$\frac{13}{40}$</p> <p>98</p> <p>86-93</p>	<p>SDUC(RL) INT</p> <p>93°</p> <p>DC..</p> <p>07 11</p> <p>$\frac{13}{40}$</p> <p>99</p> <p>86-93</p>	<p>SDUC(RL)-E INT</p> <p>93°</p> <p>DC..</p> <p>07 11</p> <p>$\frac{13}{40}$</p> <p>100</p> <p>86-93</p>	<p>SDZC(RL) INT</p> <p>93°</p> <p>DC..</p> <p>07 11</p> <p>$\frac{27}{65}$</p> <p>101</p> <p>86-93</p>
<p>SELP(RL) INT</p> <p>95°</p> <p>EP..</p> <p>05</p> <p>$\frac{8}{16}$</p> <p>111</p> <p>110</p>	<p>SELP(RL)-E INT</p> <p>95°</p> <p>EP..</p> <p>05</p> <p>$\frac{8}{16}$</p> <p>112</p> <p>110</p>	<p>SEUC(RL) INT</p> <p>93°</p> <p>EC..</p> <p>06 08</p> <p>$\frac{11}{32}$</p> <p>108</p> <p>104-106</p>	<p>SEUP(RL) INT</p> <p>93°</p> <p>EP..</p> <p>05</p> <p>8.3</p> <p>113</p> <p>110</p>
<p>SEXP(RL) INT</p> <p>52°30'</p> <p>EP..</p> <p>05</p> <p>$\frac{9.5}{16}$</p> <p>114</p> <p>110</p>	<p>SEXP(RL)-E INT</p> <p>52°30'</p> <p>EP..</p> <p>05</p> <p>$\frac{9.5}{16}$</p> <p>115</p> <p>110</p>	<p>SSSC(RL) INT</p> <p>45°</p> <p>SC..</p> <p>09</p> <p>$\frac{25}{32}$</p> <p>144</p> <p>134-138</p>	<p>STFC(RL) INT</p> <p>90°</p> <p>TC..</p> <p>06 09 11 16</p> <p>$\frac{8.5}{40}$</p> <p>158</p> <p>149-154</p>

TORNITURA ISO - INTERNA

COMPONENETI LUNGI E INSTABILI (inserti positivi)

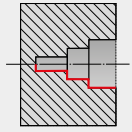

STFC(RL)-E INT	
90°	TC..
	 06 09 11
	$\frac{8.5}{20}$
160	149 – 154

SVJB(RL) INT	
93°	VB, VC..
	 11
	$\frac{25}{32}$
180, 204	168 – 171 186 – 192

SVLC(RL) INT	
95°	VC..
	 13
	$\frac{27}{43}$
205	186 – 192

SVQB(C)(RL) INT	
107°30'	VB, VC..
	 11 13 16
	$\frac{20}{50}$
181, 206	168 – 171 186 – 192

SVUB(C)(RL) INT	
93°	VB, VC..
	 11 13 16
	$\frac{20}{50}$
182, 207	168 – 171 186 – 192

SVXC(RL) INT	
113°	VC..
	 07
	$\frac{12.5}{17.5}$
208	186 – 192

SVXC(RL)-E INT	
113°	VC..
	 07
	$\frac{12.5}{17.5}$
209	186 – 192

SWLC(RL) INT	
95°	WC..
	 06 08
	$\frac{25}{40}$
216	212 – 214

SWUC(RL) INT	
93°	WC..
	 02
	$\frac{5.8}{7.8}$
217	212 – 214

SWUC(RL)-E INT	
93°	WC..
	 02
	$\frac{5.8}{7.8}$
218	212 – 214

C.-SCLC(RL) INT NEW	
95°	CC..
	 09
	$\frac{C3}{C5}$
81	60 – 69

C.-SDUC(RL) INT NEW	
93°	DC..
	 07 11
	$\frac{20}{32}$
102	86 – 93

C.-SVQB(C)(RL) INT NEW	
108°	VB, VC..
	 16
	33
183, 210	168 – 171 186 – 192

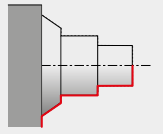

TORNITURA ISO - ESTERNA

COMPONENTI CORTI E STABILI (inserti negativi)

<p>DCBN(RL) EXT</p> <p>75°</p> <p>CN..</p> <p>12 16 19</p> <p>20×20 40×40</p> <p>240 222 – 239</p>	<p>PCBN(RL) EXT</p> <p>75°</p> <p>CN..</p> <p>12 16 19 25</p> <p>20×20 50×50</p> <p>245 222 – 239</p>	<p>DCKN(RL) EXT</p> <p>75°</p> <p>CN..</p> <p>12 16</p> <p>20×20 32×32</p> <p>242 222 – 239</p>	<p>PCKN(RL) EXT</p> <p>75°</p> <p>CN..</p> <p>12 16 19</p> <p>20×20 40×40</p> <p>246 222 – 239</p>
<p>DCLN(RL) EXT</p> <p>95°</p> <p>CN..</p> <p>09 12 16 19</p> <p>16×16 40×40</p> <p>243 222 – 239</p>	<p>PCLN(RL) EXT</p> <p>95°</p> <p>CN..</p> <p>12 16 19 25</p> <p>20×20 50×50</p> <p>247 222 – 239</p>	<p>DDJN(RL) EXT</p> <p>93°</p> <p>DN..</p> <p>11 15</p> <p>20×20 32×32</p> <p>273 260 – 272</p>	<p>PDJN(RL) EXT</p> <p>93°</p> <p>DN..</p> <p>11 15</p> <p>20×20 32×32</p> <p>274 260 – 272</p>
<p>PDNN(RL) EXT</p> <p>62°30'</p> <p>DN..</p> <p>11 15</p> <p>20×20 32×25</p> <p>275 260 – 272</p>	<p>PDXN(RL) EXT</p> <p>98°</p> <p>DN..</p> <p>15</p> <p>20×20 32×25</p> <p>276 260 – 272</p>	<p>PRDCN EXT</p> <p>RC..</p> <p>16 20 25 32</p> <p>32×25 50×50</p> <p>124 118 – 123</p>	<p>PRSC(RL) EXT</p> <p>RC..</p> <p>16 20 25</p> <p>32×25 40×40</p> <p>125 118 – 123</p>
<p>DRSN(RL) EXT</p> <p>RN..</p> <p>12</p> <p>25×25</p> <p>295 294</p>	<p>PRSN(RL) EXT</p> <p>RN..</p> <p>12 15 19</p> <p>25×25 40×40</p> <p>296 294</p>	<p>DSBN(RL) EXT</p> <p>75°</p> <p>SN..</p> <p>12 15 19</p> <p>20×20 40×40</p> <p>313 300 – 312</p>	<p>PSBN(RL) EXT</p> <p>75°</p> <p>SN..</p> <p>12 15 19 25</p> <p>20×20 50×50</p> <p>318 300 – 312</p>

TORNITURA ISO - ESTERNA
COMPONENTI CORTI E STABILI (inserti negativi)

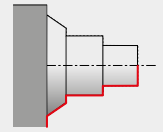

DSDNN EXT

45°

SN..

12
15
19
25

20×20
40×40

315 300–312

PSDNN EXT

45°

SN..

12
15
19
25

20×20
50×50

320 300–312

DSKN(RL) EXT

75°

SN..

12
19

25×25
32×32

316 300–312

PSKN(RL) EXT

75°

SN..

12
15
19
25

20×20
50×50

321 300–312

DSSN(RL) EXT

45°

SN..

12
15
19

20×20
40×40

317 300–312

PSSN(RL) EXT

45°

SN..

12
15
19
25

20×20
50×50

323 300–312

DTFN(RL) EXT

90°

TN..

16
22

20×20
25×25

345 334–344

PTFN(RL) EXT

90°

TN..

16
22
27

16×16
40×40

348 334–344

DTGN(RL) EXT

90°

TN..

16
22

20×20
32×25

346 334–344

PTGN(RL) EXT

90°

TN..

16
22
27

16×16
40×40

349 334–344

MTJN(RL) EXT

93°

TN..

16
22

16×16
32×32

347 334–344

PTTN(RL) EXT

60°

TN..

16
22

20×20
32×25

350 334–344

DVJN(RL) EXT

93°

VN..

16

20×20
32×25

360 356–376

MVJN(RL) EXT

93°

VN..

16

20×20
32×25

362 356–376

DVPN(RL) EXT

62°30'

VN..

16

20×20
32×25

361 356–376

DWLN(RL) EXT

95°

WN..

06
08
10
13

16×16
40×40

377 366–376

TORNITURA ISO - ESTERNA

COMPONENTI CORTI E STABILI (inserti negativi)

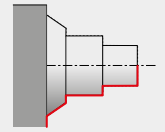

MWLN(RL) EXT

95°	WN..
	 08
	25×25 40×40
 379	 366 – 376

PWLN(RL) EXT

95°	WN..
	 06 08
	16×16 32×25
 380	 366 – 376

C.-DCLN(RL) EXT **NEW**

95°	CN..
	 12 16 19
	C3 C8
 249	 222 – 239

C.-DDJN(RL) EXT **NEW**

93°	DN..
	 11 15
	C4 C6
 277	 260 – 272

C.-DDNNN EXT **NEW**

62.5°	DN..
	 15
	C5 C6
 278	 260 – 272

C.-DDUN(RL) EXT **NEW**

93°	DN..
	 15
	C5 C6
 279	 260 – 272

C.-DRSN(RL) EXT **NEW**

	RN..
	 12
	C6
 297	 294

C.-DSRN(RL) EXT **NEW**

75°	SN..
	 12 19
	C4 C6
 326	 300 – 312

C.-DSDNN EXT **NEW**

45°	SN..
	 12 19
	C4 C6
 324	 300 – 312

C.-DSKN(RL) EXT **NEW**

75°	SN..
	 12
	C4
 325	 300 – 312

C.-DSSN(RL) EXT **NEW**

45°	SN..
	 12
	C4 C5
 327	 300 – 312

C.-DTJN(RL) EXT **NEW**

93°	TN..
	 16
	C4 C5
 351	 334 – 344

C.-DVJN(RL) EXT **NEW**

93°	VN..
	 16
	C4 C6
 363	 356 – 376

C.-DWLN(RL) EXT **NEW**

95°	WN..
	 06 08
	C4 C6
 381	 366 – 376

TORNITURA ISO - INTERNA



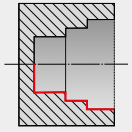





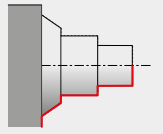













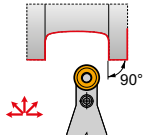

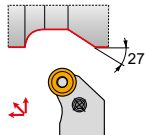

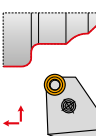

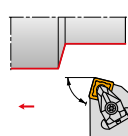

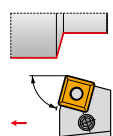
COMPONENTI CORTI E STABILI (inserti negativi)

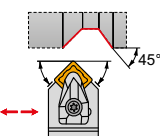

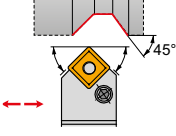
<p>DCLN(RL) INT</p> <p>95°</p> <p>CN..</p> <p>09 12</p> <p>$\frac{32}{50}$</p> <p>254 222-239</p>	<p>PCLN(RL) INT</p> <p>95°</p> <p>CN..</p> <p>09 12 16 19</p> <p>$\frac{20}{80}$</p> <p>255 222-239</p>	<p>DDUN(RL) INT</p> <p>93°</p> <p>DN..</p> <p>11 15</p> <p>$\frac{25}{50}$</p> <p>280 260-272</p>	<p>PDUN(RL) INT</p> <p>93°</p> <p>DN..</p> <p>11 15</p> <p>$\frac{25}{60}$</p> <p>281 260-272</p>
<p>PSKN(RL) INT</p> <p>93°</p> <p>SN..</p> <p>11 15</p> <p>$\frac{32}{80}$</p> <p>331 300-312</p>	<p>DTFN(RL) INT</p> <p>90°</p> <p>TN..</p> <p>16 22</p> <p>$\frac{32}{50}$</p> <p>352 334-344</p>	<p>PTFN(RL) INT</p> <p>90°</p> <p>TN..</p> <p>16 22</p> <p>$\frac{32}{50}$</p> <p>353 334-344</p>	<p>DVUN(RL) INT</p> <p></p> <p>VN..</p> <p>16</p> <p>50</p> <p>364 356-376</p>
<p>DWLN(RL) INT</p> <p>95°</p> <p>WN..</p> <p>06 08</p> <p>$\frac{32}{63}$</p> <p>382 366-376</p>	<p>PWLN(RL) INT</p> <p>95°</p> <p>WN..</p> <p>06 08</p> <p>$\frac{20}{80}$</p> <p>383 366-376</p>	<p>C.-DCLN(RL) INT NEW</p> <p>95°</p> <p>CN..</p> <p>09 12 16</p> <p>$\frac{25}{50}$</p> <p>257 222-239</p>	<p>C.-DDUN(RL) INT NEW</p> <p>93°</p> <p>DN..</p> <p>11</p> <p>12</p> <p>282 260-272</p>
<p>C.-DTFN(RL) INT NEW</p> <p>91°</p> <p>TN..</p> <p>16</p> <p>32</p> <p>354 334-344</p>	<p>C.-DWLN(RL) INT NEW</p> <p>95°</p> <p>WN..</p> <p>06 08</p> <p>$\frac{27}{33}$</p> <p>385 366-376</p>		

TORNITURA ISO - SGROSSATURA PESANTE - ESTERNA
 UTENSILI INTEGRALI

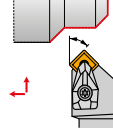

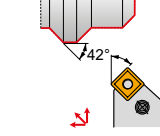





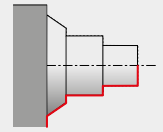

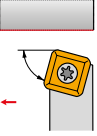
<p>DCBN(RL) EXT</p> <p>75°</p> <p>CN..</p>  <p>19</p>  <p>40×40</p> <p>240</p> <p>222 – 239</p>	<p>PCBN(RL) EXT</p> <p>75°</p> <p>CN..</p>  <p>19</p> <p>25</p>  <p>40×40 50×50</p> <p>245</p> <p>222 – 239</p>	<p>PCKN(RL) EXT</p> <p>75°</p> <p>CN..</p>  <p>19</p>  <p>40×40</p> <p>246</p> <p>222 – 239</p>	<p>DCLN(RL) EXT</p> <p>95°</p> <p>CN..</p>  <p>19</p>  <p>40×40</p> <p>243</p> <p>222 – 239</p>
<p>PCLN(RL) EXT</p> <p>95°</p> <p>CN..</p>  <p>19</p> <p>25</p>  <p>40×40 50×50</p> <p>247</p> <p>222 – 239</p>	<p>PLBN(RL) EXT</p> <p>75°</p> <p>LN..</p>  <p>40</p> <p>50</p>  <p>60×60</p> <p>290</p> <p>289</p>	<p>PRDCN EXT</p> <p>RC..</p>  <p>20</p> <p>25</p> <p>32</p>  <p>40×40 50×50</p> <p>124</p> <p>118 – 123</p>	<p>PRSC(RL) EXT</p> <p>RC..</p>  <p>16</p> <p>25</p>  <p>40×40</p> <p>125</p> <p>118 – 123</p>
<p>PRSN(RL) EXT</p> <p>RN..</p>  <p>19</p>  <p>40×40</p> <p>296</p> <p>294</p>	<p>DSBN(RL) EXT</p> <p>75°</p> <p>SN..</p>  <p>19</p>  <p>40×40</p> <p>313</p> <p>300 – 312</p>	<p>PSBN(RL) EXT</p> <p>75°</p> <p>SN..</p>  <p>19</p> <p>25</p>  <p>40×40 50×50</p> <p>318</p> <p>300 – 312</p>	<p>DSDNN EXT</p> <p>45°</p> <p>SN..</p>  <p>19</p> <p>25</p>  <p>40×40</p> <p>315</p> <p>300 – 312</p>
<p>PSDNN EXT</p> <p>45°</p> <p>SN..</p>  <p>19</p> <p>25</p>  <p>40×40 50×50</p> <p>320</p> <p>300 – 312</p>	<p>PSKN(RL) EXT</p> <p>75°</p> <p>SN..</p>  <p>19</p> <p>25</p>  <p>40×40 50×50</p> <p>321</p> <p>300 – 312</p>	<p>DSSN(RL) EXT</p> <p>45°</p> <p>SN..</p>  <p>19</p>  <p>40×40</p> <p>317</p> <p>300 – 312</p>	<p>PSSN(RL) EXT</p> <p>45°</p> <p>SN..</p>  <p>19</p> <p>25</p>  <p>40×40 50×50</p> <p>323</p> <p>300 – 312</p>



TORNITURA ISO - SGROSSATURA PESANTE - ESTERNA
UTENSILI INTEGRALI

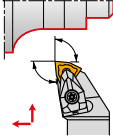

SSBC(RL) EXT	
75°	SC..
	 25 38
 40x40 60x60	
 139	 134 – 138

DWLN(RL) EXT	
95°	WN..
	 13
 40x40	
 377	 366 – 376

TORNITURA ISO - SGROSSATURA PESANTE - ESTERNA
TESTE (KH)

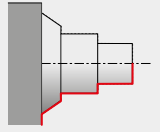

KHP-CBNR + DKH(RL)

75°

CN..

25

DKHR+KHP-CBNR

	40×50 60×80
--	----------------

251, 253 222 – 239

KHP-CBNL + DKH(RL)

75°

CN..

25

DKHR+KHP-CBNL

	40×50 60×80
--	----------------

251, 253 222 – 239

KHP-CLNR/L + DKH(RL)

95°

CN..

19
25

DKHR+KHP-CLNR

	40×50 60×80
--	----------------

252, 253 222 – 239

KHP-LBNR + DKH(RL)

75°

LN..

40

DKHR+KHP-LBNR

	40×50 60×80
--	----------------

291, 292 289

KHP-LBNL + DKH(RL)

75°

LN..

40

DKHR+KHP-LBNL

	40×50 60×80
--	----------------

291, 292 289

KHP-RSCR/L + DKH(RL)

RC..

20
25
32

DKHR+KHP-RSCR

	40×50 60×80
--	----------------

131, 132 118 – 123

KHP-SBNR + DKH(RL)

75°

SN..

25

DKHR+KHP-SBNR

	40×50 60×80
--	----------------

328, 330 300 – 312

KHP-SBNL + DKH(RL)

75°

SN..

25

DKHR+KHP-SBNL

	40×50 60×80
--	----------------

328, 330 300 – 312

KHP-SSNR/L + DKH(RL)

45°

SN..

19
25

DKHR+KHP-SSNR

	40×50 60×80
--	----------------

329, 330 300 – 312

KHS-SBCR + DKH(RL)

75°

SC..

25
38

DKHR+KHS-SBC

	40×50 60×80
--	----------------

142, 143 134 – 138

KHS-SBCL + DKH(RL)

75°

SC..

25
38

DKHR+KHS-SBCL

	40×50 60×80
--	----------------

142, 143 134 – 138



DORMER PRAMET



SEMPRE CONNESSI

Nessuna connessione Wi-Fi o internet? L'app Calculators lavora perfettamente anche se siete offline, garantendo la piena disponibilità quando ne avete bisogno. **Semplicemente affidabili.**

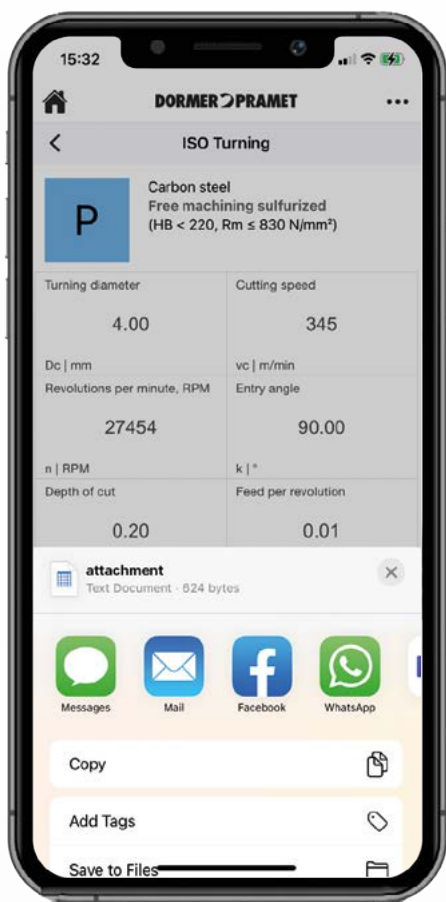



DORMER PRAMET

SEGUITECI



SHARE



LIKE



COMMENT



TAG



RE-TWEET





INSERTI – CODICE D'IDENTIFICAZIONE ISO

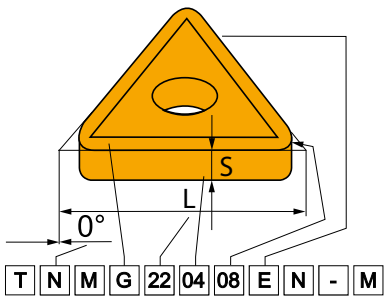

ISO	1	2	3	4
	T	N	U	N
ANSI	1	2	3	4
	T	N	U	G

1				2				4					
Forma inserto				Angolo di spoglia inferiore				Tipologia inserto					
H	O	P	R	A		B		N		R		F	
S	T	C	D	C		D		A		M		G	
E	M	V	W	E		F		W		T		Q	
L	A	B	K	G		N		U		B		H	
				P		O	Special	J		C		X	Special

3									
Tolleranze									
	(mm)			(")					
	M(±)	S(±)	IC(±)	M(±)	S(±)	IC(±)			
A	0.005	0.025	0.025	.0002"	.001"	.0010"			
F	0.005	0.025	0.013	.0002"	.001"	.0005"			
C	0.013	0.025	0.025	.0005"	.001"	.0010"			
H	0.013	0.025	0.013	.0005"	.001"	.0005"			
E	0.025	0.025	0.025	.0010"	.001"	.0010"			
G	0.025	0.130	0.025	.0010"	.005"	.0010"			
J	0.005	0.025	0.05 – 0.13	.0002"	.001"	.002 – 0.005"			
K	0.013	0.025	0.05 – 0.13	.0005"	.001"	.002 – 0.005"			
L	0.025	0.025	0.05 – 0.13	.0010"	.001"	.002 – 0.005"			
M	0.08 – 0.18	0.130	0.05 – 0.13	.003 – 0.007"	.005"	.002 – 0.005"			
N	0.08 – 0.18	0.025	0.05 – 0.13	.003 – 0.007"	.001"	.002 – 0.005"			
U	0.05 – 0.38	0.130	0.05 – 0.13	.005 – 0.015"	.005"	.003 – 0.010"			

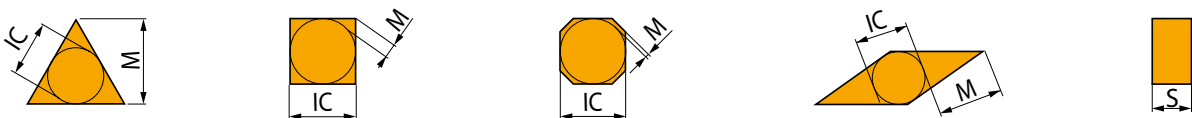



INSERTI – CODICE D'IDENTIFICAZIONE ISO

5	6	7	8	9	10
22	04	08			
22	04	08	E	N	M
5	6	7	8	9	10
4	3	2			
4	3	2	E	N	M

5		5												
Lunghezza del tagliente (dimensione inserto)														
d = IC		H	O	P	S	T	C	D	E	M	V	W	R	K
(mm)	(in)													
3.97	5/32"				03	06		04			06	02		
4.76	3/16"				04	08	04	05	04	04	08	L3		
5.56	7/32"				05	09	05	06	05	05	09	03		
6.35	1/4"	03	02	04	08	11	06	07	08	08	11	04	06	
7.94	5/16"	04	03	05	07	13	08	09	06	07	13	05	07	
9.525	3/8"	05	04	07	09	16	09	11	09	09	16	06	09	16
12.7	1/2"	07	05	09	12	22	12	15	13	12	22	08	12	
15.875	5/8"	09	06	11	15	27	16	19	16	15	27	10	15	
19.05	3/4"	11	07	13	19	33	19	23	19	19	33	13	19	
25.40	1"	14	10	18	25	44	25	31	26	25	44	17	25	
31.75	1 1/4"	18	13	23	31	54	32	38	32	31	54	21	31	

6	
Spessore inserto	
	S
	(mm) (")
01	1.59 1/16"
T1	1.98 5/64"
02	2.38 3/32"
03	3.18 1/8"
T3	3.97 5/32"
04	4.76 3/16"
05	5.56 7/32"
06	6.35 1/4"
07	7.94 5/16"
09	9.52 3/8"

7	
Raggio di punta inserto	
	RE
	(mm) (")
00	0 0"
02	0.2 1/128"
04	0.4 1/64"
08	0.8 1/32"
12	1.2 3/64"
16	1.6 1/16"
24	2.4 3/32"
32	3.2 1/8"
Inserto Tondo	
d = I.C.	
(")	00
(mm)	M0

ANSI						
5		6		7		
Cerchio inscritto		Spessore inserto		Raggio di punta inserto		
Symbol d = I.C.		Symbol S		Symbol RE		
		(mm) (")		(mm) (")		
1	3.175 1/8"	1	1.588 1/16"	0	0	0"
1.2	3.969 5/32"	1.2	1.984 5/64"	0.2	0.099	1/256"
1.5	4.763 3/16"	1.5	2.381 3/32"	0.5	0.198	1/128"
1.8	5.556 7/32"	2	3.175 1/8"	1	0.397	1/64"
2	6.350 1/4"	2.5	3.969 5/32"	2	0.794	1/32"
2.5	7.938 5/16"	3	4.763 3/16"	3	1.191	3/64"
3	9.525 3/8"	3.5	5.556 7/32"	4	1.588	1/16"
4	12.700 1/2"	4	6.350 1/4"	5	1.984	5/64"
5	15.875 5/8"	5	7.938 5/16"	6	2.381	3/32"
6	19.050 3/4"	6	9.525 3/8"	7	2.778	7/64"
7	22.225 7/8"	7	11.113 7/16"	8	3.175	1/8"
8	25.400 1"	8	12.700 1/2"	10	3.969	5/32"
10	31.750 5/4"	9	14.288 9/16"	12	4.763	3/16"
12	38.100 6/4"	10	15.875 5/8"	14	5.556	7/32"
				16	6.350	1/4"

8		8	
Microgeometria del tagliente			
	Tagliente vivo		Tagliente arrotondato
	Tagliente con piano di rinforzo		Tagliente arrotondato con piano di rinforzo
	Tagliente con doppio piano di rinforzo		Tagliente arrotondato con doppio piano di rinforzo

9		9	
Direzione avanzamento			
R	Avanzamento		Avanzamento
L	Avanzamento		
10		10	
Designazione rompitrucolo			



UTENSILI PER TORNITURA ESTERNA – DESIGNAZIONE CODICE ISO

Utensile a stelo	ISO	2	3	4	5	6	7	8	11	12	13
		P	C	L	N	R	- 32	25	L	12	- M
PSC	ISO	1	2	3	4	5	6	9	10	12	
		C4	- D	C	L	N	R	- 27	050	- 12	
Utensile a stelo	ANSI	2	3	4	5	6	7 & 8	12	11		
		D	C	L	N	R	- 16	4	D		

1	1	2	2	3				4					
Dimensione accoppiamento		Tipo di bloccaggio		Forma inserto				Tipo di utensile - angolo di entrata					
	C			H	O	P	R	A	B	C	D	D	
	C3	32			S	T	C	D					
	C4	40											
	C5	50			E	M	V	W					
	C6	63											
	C8	80			L	A	B	K				Speciale	
				G									

5		5	
Angolo di spoglia inferiore			
N	B	C	P
0°	5°	7°	11°

6		6	
Direzione di taglio			
R		L	
N			

7 & 8		
Dimensioni dello stelo (")		
Symbol	B (")	H (")
05	5/16"	5/16"
06	3/8"	3/8"
08	1/2"	1/2"
10	5/8"	5/8"
12	3/4"	3/4"
16	1"	1"
85	1"	1 1/4"
86	1"	1 1/2"
20	1 1/4"	1 1/4"
24	1 1/2"	1 1/2"
32	2"	2"

11		11	
Lunghezza totale utensile			
		LF [mm]	
D	60	D	60
E	70	E	70
F	80	F	80
H	100	H	100
J	110	J	110
K	125	K	125
L	140	L	140
M	150	M	150
N	160	N	160
P	170	P	170
Q	180	Q	180
R	200	R	200
S	250	S	250
T	300	T	300
U	350	U	350
V	400	V	400
W	450	W	450
X	Spec.	X	Spec.
Y	500	Y	500

7					
Altezza utensile (mm)					
08	10	12	16	20	25
32	38	40	45	50	60

Per steli quadrati, il numero è la larghezza o l'altezza espressa in sedicesimi di pollice.
 Per steli rettangolari la prima cifra è la larghezza in ottavi di pollice e la seconda cifra è l'altezza in quarti di pollice.

8					
Larghezza utensile (mm)					
08	10	12	16	20	25
32	38	40	45	50	60

9		10	
Larghezza funzionale [mm]		Lunghezza funzionale [mm]	
WF		LF	



UTENSILI PER TORNITURA INTERNA – DESIGNAZIONE CODICE ISO

ISO	15	16	17	-	2	3	4	5	6	12	-	14
ANSI	A	16	T	-	D	C	L	N	L	4		

		12												
		Lunghezza del tagliente (dimensione inserto)												
d=I.C.		H	O	P	S	T	C	D	E	M	V	W	R	K
(mm)	(")													
3.97					03	06		04			06	02		
	5/32"					1.2								
4.76					04	08	04	05	04	04	08	L3		
	3/16"					1.5								
5.56					05	09	05	06	05	05	09	03		
	7/32"					1.8								
6.35		03	02	04	08	11	06	07	08	08	11	04	06	
	1/4"					2								
7.94		04	03	05	07	13	08	09	06	07	13	05	07	
	5/16"					2.5								
9.525		05	04	07	09	16	09	11	09	09	16	06	09	16
	3/8"					3								
12.7		07	05	09	12	22	12	15	13	12	22	08	12	
	1/2"					4								
15.875		09	06	11	15	27	16	19	16	15	27	10	15	
	5/8"					5								
19.05		11	07	13	19	33	19	23	19	19	33	13	19	
	3/4"					6								
25.40		14	10	18	25	44	25	31	26	25	44	17	25	
	1"					8								
31.75		18	13	23	31	54	32	38	32	31	54	21	31	
	1 1/4"					10								

13	
Designazione costruttore	
M	Sistema di bloccaggio "S" con supporto

14	
Designazione costruttore	
X	Speciale forma dello stelo
•	
•	
93	Z – Utensile ad angolo registrabile
•	
•	

15		15
Tipo di stelo		
S	Senza foro per passaggio refrigerante	
A	Con foro per passaggio refrigerante	
E	Utensile con stelo in metallo duro integrale con foro per passaggio refrigerante	

16		16	
Ø stelo [mm]			
DCON MS [mm]		DCON MS (")	
08	8	03	.1875"
10	10	04	.250"
12	12	05	.3125"
16	16	06	.375"
20	20	08	.500"
25	25	10	.625"
32	32	12	.750"
40	40	16	1.000"
50	50	20	1.250"
60	60	24	1.500"
		32	2.000"

17		17	
Lunghezza totale utensile			
		LF [mm]	
		D	60
		E	70
		F	80
		H	100
		J	110
		K	125
F	LF (")	L	140
H	3.250"	M	150
K	4.000"	N	160
M	5.000"	P	170
P	6.250"	Q	180
Q	7.250"	R	200
R	8.000"	S	250
S	10.000"	T	300
T	12.000"	U	350
U	14.000"	V	400
V	15.750"	W	450
W	17.750"	X	Spec.
Y	20.000"	Y	500
X	Spec.		



TESTE – DESIGNAZIONE CODICE ISO

CARTUCCIA

1	2	–	3	4	5	6	7
KH	P		C	L	N	R	25

UTENSILE

8	6	9	10	11
DKH	R	50	60	W

1	2	3	4
Cartuccia	Tipo di bloccaggio	Forma inserto	Tipo di utensile - angolo di entrata
5 Angolo di spoglia inferiore	C	S	A
	D	T	B
N 0°	P	R	C
C 7°	M	W	D 45°
P 11°	S	L	D
6 Direzione di taglio	X	V	E
R	G	X Special	F
L			G
N			H
			J
			K
			L
			M
			N
			P
			Q
			R
			S
			S
			T
			U
			V
			W
			X Special
			Y
			Z

7		Lunghezza del tagliente (dimensione inserto)												
d = I.C.		H	O	P	S	T	C	D	E	M	V	W	R	K
(mm)	(")													
3.97	5/32"				03	06		04			06	02		
4.76	3/16"				04	08	04	05	04	04	08	L3		
5.56	7/32"				05	09	05	06	05	05	09	03		
6.35	1/4"	03	02	04	08	11	06	07	08	08	11	04	06	
7.94	5/16"	04	03	05	07	13	08	09	06	07	13	05	07	
9.525	3/8"	05	04	07	09	16	09	11	09	09	16	06	09	16
12.7	1/2"	07	05	09	12	22	12	15	13	12	22	08	12	
15.875	5/8"	09	06	11	15	27	16	19	16	15	27	10	15	
19.05	3/4"	11	07	13	19	33	19	23	19	19	33	13	19	
25.40	1"	14	10	18	25	44	25	31	26	25	44	17	25	
31.75	1 1/4"	18	13	23	31	54	32	38	32	31	54	21	31	

8
Utensile per cartuccia

9
Altezza utensile (mm)

	08	10	12	16	20	25
	32	40	50	60	70	80

10
Larghezza utensile (mm)

	08	10	12	16	20	25
	32	40	50	60	70	80

11
Lunghezza totale utensile

	LF (mm)
H	100
J	110
K	125
L	140
M	150
N	160
P	170
Q	180
R	200
S	250
T	300
U	350
V	400
W	450
X	Spec.
Y	500

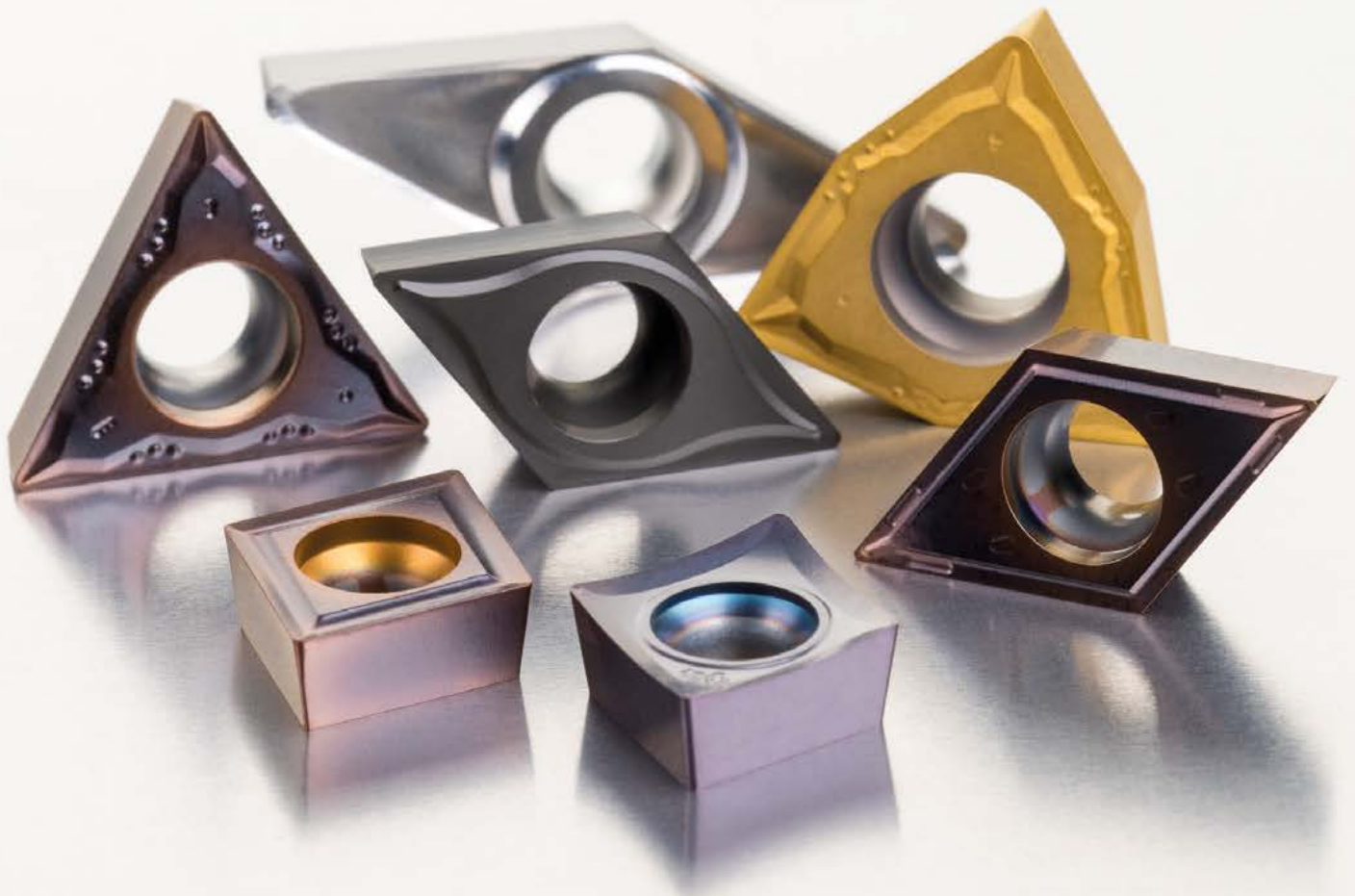

INSERTI POSITIVI



CC

06 / 08 / 09 / 12

INSERTI IN METALLO DURO

CCGT



60

CCMT



62

CCMW



68

INSERTI CBN

CCGW CBN



69

ABBINAMENTO DELLA DIMENSIONE CORRETTA (esempio)

Inserto
Portainsero

CCMT 120404E-UR

S32U-SCKCR 12-A

TORNITURA ISO - ESTERNA

SCAC(RL) EXT

90°

CC..

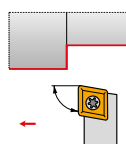
06
09
 08×08
16×16

70

60-69

SCBC(RL) EXT

75°

CC..

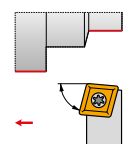
09
12
 12×12
25×25

71

60-69

SCDCR EXT

45°

CC..

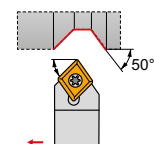

06

10×10

72

60-69

SCFC(RL) EXT

90°

CC..

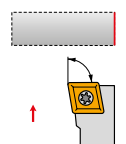
06
09
 08×08
16×16

73

60-69

SCLC(RL) EXT

95°

CC..

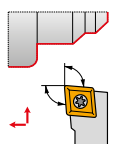
06
08
09
12
 08×08
25×25

74

60-69

C.-SCLC(RL) EXT **NEW**

95°

CC..

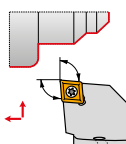
09
12
 C3
C5

75

60-69



CC

06 / 08 / 09 / 12

TORNITURA ISO INTERNA

SCFC(RL) INT

90°

CC..

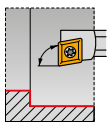

06

 $\frac{13}{16}$

76

60-69

SCKC(RL) INT

75°

CC..



06

09

12

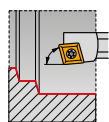
 $\frac{11}{40}$

77

60-69

SCLC(RL) INT

95°

CC..



06

09

12

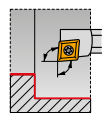
 $\frac{11}{40}$

78

60-69

SCXC(RL) INT

40°

CC..

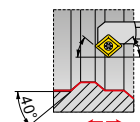

06

 $\frac{13}{20}$

80

60-69

C.-SCLC(RL) INT **NEW**

95°

CC..

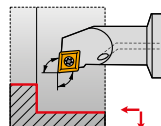

09

 $\frac{20}{32}$

81

60-69



CCGT



	IC	D1	L	S
	(mm)	(mm)	(mm)	(mm)
0602	6.350	2.80	6.40	2.38
0602-SF3	6.350	2.80	6.40	2.58
0803-AL	7.940	3.40	8.10	3.43
0803-SF3	7.940	3.40	8.10	3.43
09T3	9.525	4.40	9.70	3.97
09T3-SF3	9.525	4.40	9.70	4.22
1204	12.700	5.50	12.90	4.76
1204-SF3	12.700	5.50	12.90	5.01

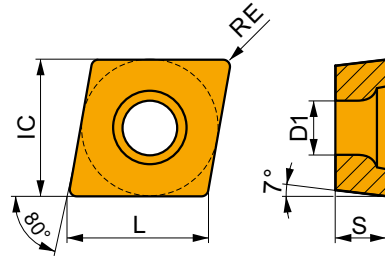

Idoneità e valori iniziali per velocità di taglio (Vc), avanzamento (f) e profondità di taglio (ap). Fare riferimento alla nostra App Machining Calculator per ulteriori calcoli.

Codice prodotto	RE	P			M			K			N			S			H		
		vc	f	ap	vc	f	ap	vc	f	ap	vc	f	ap	vc	f	ap	vc	f	ap
	(mm)	(m/min)	(mm/rev)	(mm)	(m/min)	(mm/rev)	(mm)	(m/min)	(mm/rev)	(mm)	(m/min)	(mm/rev)	(mm)	(m/min)	(mm/rev)	(mm)	(m/min)	(mm/rev)	(mm)



AL geometria con design altamente positivo per operazioni da finitura fino a sgrossatura, da taglio continuo a leggermente interrotto.

CCGT 060202F-AL	HF7	0.2	-	-	-	-	-	-	450	0.12	1.0	-	-	-	-	-	-	-
	T0315	0.2	-	-	-	-	-	-	645	0.12	1.0	-	-	-	-	-	-	-
CCGT 060204F-AL	HF7	0.4	-	-	-	-	-	-	360	0.24	1.0	-	-	-	-	-	-	-
	T0315	0.4	-	-	-	-	-	-	525	0.24	1.0	-	-	-	-	-	-	-
CCGT 080302F-AL	T0315	0.2	-	-	-	-	-	-	645	0.12	1.0	-	-	-	-	-	-	-
CCGT 080304F-AL	HF7	0.4	-	-	-	-	-	-	360	0.24	1.0	-	-	-	-	-	-	-
	T0315	0.4	-	-	-	-	-	-	525	0.24	1.0	-	-	-	-	-	-	-
CCGT 09T302F-AL	HF7	0.2	-	-	-	-	-	-	450	0.12	1.0	-	-	-	-	-	-	-
	T0315	0.2	-	-	-	-	-	-	645	0.12	1.0	-	-	-	-	-	-	-
CCGT 09T304F-AL	HF7	0.4	-	-	-	-	-	-	345	0.24	1.5	-	-	-	-	-	-	-
	T0315	0.4	-	-	-	-	-	-	495	0.24	1.5	-	-	-	-	-	-	-
CCGT 09T308F-AL	HF7	0.8	-	-	-	-	-	-	315	0.48	1.5	-	-	-	-	-	-	-
	T0315	0.8	-	-	-	-	-	-	450	0.48	1.5	-	-	-	-	-	-	-
CCGT 120404F-AL	HF7	0.4	-	-	-	-	-	-	330	0.24	2.4	-	-	-	-	-	-	-
	T0315	0.4	-	-	-	-	-	-	480	0.24	2.4	-	-	-	-	-	-	-
CCGT 120408F-AL	HF7	0.8	-	-	-	-	-	-	300	0.48	2.4	-	-	-	-	-	-	-
	T0315	0.8	-	-	-	-	-	-	435	0.48	2.4	-	-	-	-	-	-	-

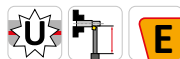
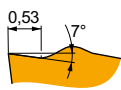

FF2 geometria positiva per operazioni da super finitura fino a finitura, da taglio continuo a leggermente interrotto.

CCGT 09T302E-FF2	T7325	0.2	235	0.05	1.0	-	-	-	-	-	-	-	-	-	-	-	-	-
	T9325	0.2	345	0.05	1.0	-	-	-	325	0.05	1.0	-	-	-	-	-	-	-

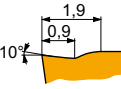

NF1 geometria con design positivo per operazioni da finitura fino a medie lavorazioni, taglio continuo.

CCGT 060204E-NF1	H07	0.4	-	-	-	95	0.09	0.8	-	-	-	485	0.12	0.8	45	0.07	0.6	-	-	-
	T6310	0.4	180	0.10	0.8	125	0.09	0.8	-	-	-	540	0.12	0.8	50	0.07	0.6	35	0.15	1.0
	T7325	0.4	210	0.10	0.8	160	0.09	0.8	-	-	-	-	-	-	65	0.07	0.6	-	-	-
CCGT 060208E-NF1	T6310	0.8	205	0.12	0.8	145	0.11	0.8	-	-	-	615	0.14	0.8	60	0.11	0.6	40	0.15	1.0
	T7325	0.8	235	0.12	0.8	180	0.11	0.8	-	-	-	-	-	-	75	0.11	0.6	-	-	-
CCGT 09T304E-NF1	H07	0.4	-	-	-	90	0.09	1.2	-	-	-	470	0.12	1.2	45	0.07	1.0	-	-	-
	T6310	0.4	175	0.10	1.2	125	0.09	1.2	-	-	-	525	0.12	1.2	50	0.07	1.0	35	0.15	1.0
	T7325	0.4	200	0.10	1.2	155	0.09	1.2	-	-	-	-	-	-	65	0.07	1.0	-	-	-
CCGT 09T308E-NF1	T6310	0.8	190	0.14	1.2	135	0.13	1.2	-	-	-	570	0.17	1.2	55	0.13	1.0	35	0.15	1.0
	T7325	0.8	215	0.14	1.2	165	0.13	1.2	-	-	-	-	-	-	65	0.13	1.0	-	-	-



Idoneità e valori iniziali per velocità di taglio (Vc), avanzamento (f) e profondità di taglio (ap). Fare riferimento alla nostra App Machining Calculator per ulteriori calcoli.

Codice prodotto	RE  (mm)	P			M			K			N			S			H		
		vc (m/min)	f (mm/rev)	ap (mm)	vc (m/min)	f (mm/rev)	ap (mm)	vc (m/min)	f (mm/rev)	ap (mm)	vc (m/min)	f (mm/rev)	ap (mm)	vc (m/min)	f (mm/rev)	ap (mm)	vc (m/min)	f (mm/rev)	ap (mm)

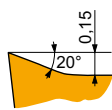

SF3 geometria con design altamente positivo per lavorazioni leggere e finitura, taglio continuo.

CCGT 060201E-SF3	T6310	0.1	200	0.05	0.5	140	0.05	0.5	160	0.05	0.5	600	0.06	0.5	60	0.04	0.4	40	0.15	1.0
CCGT 060202E-SF3	H07	0.2	-	-	-	120	0.05	0.8	190	0.05	0.8	605	0.06	0.8	60	0.04	0.6	-	-	-
	T6310	0.2	205	0.05	0.8	145	0.05	0.8	165	0.05	0.8	615	0.06	0.8	60	0.04	0.6	40	0.15	1.0
	T8315	0.2	215	0.05	0.8	125	0.05	0.8	200	0.05	0.8	645	0.06	0.8	50	0.04	0.6	40	0.15	1.0
CCGT 060204E-SF3	H07	0.4	-	-	-	95	0.09	0.8	150	0.10	0.8	485	0.12	0.8	45	0.07	0.6	-	-	-
	T6310	0.4	180	0.10	0.8	125	0.09	0.8	145	0.10	0.8	540	0.12	0.8	50	0.07	0.6	35	0.15	1.0
	T8315	0.4	190	0.10	0.8	110	0.09	0.8	180	0.10	0.8	570	0.12	0.8	45	0.07	0.6	35	0.15	1.0
CCGT 080302E-SF3	T6310	0.2	205	0.05	0.8	145	0.05	0.8	165	0.05	0.8	615	0.06	0.8	60	0.04	0.6	40	0.15	1.0
	T8315	0.2	215	0.05	0.8	125	0.05	0.8	200	0.05	0.8	645	0.06	0.8	50	0.04	0.6	40	0.15	1.0
CCGT 080304E-SF3	H07	0.4	-	-	-	95	0.09	1.0	150	0.10	1.0	485	0.12	1.0	45	0.07	0.8	-	-	-
	T6310	0.4	180	0.10	1.0	125	0.09	1.0	145	0.10	1.0	540	0.12	1.0	50	0.07	0.8	35	0.15	1.0
	T8315	0.4	190	0.10	1.0	110	0.09	1.0	180	0.10	1.0	570	0.12	1.0	45	0.07	0.8	35	0.15	1.0
CCGT 09T301E-SF3	T6310	0.1	200	0.05	0.5	140	0.05	0.5	160	0.05	0.5	600	0.06	0.5	60	0.04	0.4	40	0.15	1.0
CCGT 09T302E-SF3	H07	0.2	-	-	-	120	0.05	0.8	190	0.05	0.8	605	0.06	0.8	60	0.04	0.6	-	-	-
	T6310	0.2	205	0.05	0.8	145	0.05	0.8	165	0.05	0.8	615	0.06	0.8	60	0.04	0.6	40	0.15	1.0
	T8315	0.2	215	0.05	0.8	125	0.05	0.8	200	0.05	0.8	645	0.06	0.8	50	0.04	0.6	40	0.15	1.0
CCGT 09T304E-SF3	H07	0.4	-	-	-	95	0.09	1.0	150	0.10	1.0	485	0.12	1.0	45	0.07	0.8	-	-	-
	T6310	0.4	180	0.10	1.0	125	0.09	1.0	145	0.10	1.0	540	0.12	1.0	50	0.07	0.8	35	0.15	1.0
	T8315	0.4	190	0.10	1.0	110	0.09	1.0	180	0.10	1.0	570	0.12	1.0	45	0.07	0.8	35	0.15	1.0
CCGT 09T308E-SF3	H07	0.8	-	-	-	110	0.09	1.0	175	0.10	1.0	565	0.12	1.0	55	0.08	0.8	-	-	-
	T6310	0.8	210	0.10	1.0	150	0.09	1.0	165	0.10	1.0	630	0.12	1.0	60	0.08	0.8	40	0.15	1.0
	T8315	0.8	225	0.10	1.0	135	0.09	1.0	210	0.10	1.0	675	0.12	1.0	55	0.08	0.8	45	0.15	1.0
CCGT 120404E-SF3	T6310	0.4	180	0.10	1.0	125	0.09	1.0	145	0.10	1.0	540	0.12	1.0	50	0.07	0.8	35	0.15	1.0
CCGT 120408E-SF3	H07	0.8	-	-	-	105	0.12	1.0	165	0.12	1.0	525	0.14	1.0	50	0.11	0.8	-	-	-
	T6310	0.8	200	0.12	1.0	140	0.12	1.0	160	0.12	1.0	600	0.14	1.0	60	0.11	0.8	40	0.15	1.0
	T8315	0.8	210	0.12	1.0	125	0.12	1.0	195	0.12	1.0	630	0.14	1.0	50	0.11	0.8	40	0.15	1.0



ER-SI geometria positiva destra per operazioni di finitura, taglio continuo.

CCGT 060202ER-SI	T8330	0.2	215	0.10	0.8	125	0.09	0.8	200	0.10	0.8	-	-	-	50	0.08	0.6	-	-	-
	T8430	0.2	260	0.10	0.8	140	0.09	0.8	215	0.10	0.8	-	-	-	55	0.08	0.6	-	-	-
CCGT 060204ER-SI	T8315	0.4	225	0.12	0.8	135	0.11	0.8	210	0.12	0.8	-	-	-	55	0.10	0.6	-	-	-
	T8330	0.4	215	0.12	0.8	125	0.11	0.8	200	0.12	0.8	-	-	-	50	0.10	0.6	-	-	-
	T8430	0.4	260	0.12	0.8	140	0.11	0.8	215	0.12	0.8	-	-	-	55	0.10	0.6	-	-	-
CCGT 09T304ER-SI	T8315	0.4	205	0.17	0.8	120	0.15	0.8	190	0.17	0.8	-	-	-	50	0.15	0.6	-	-	-
	T8330	0.4	195	0.17	0.8	115	0.15	0.8	185	0.17	0.8	-	-	-	45	0.15	0.6	-	-	-
	T8430	0.4	230	0.17	0.8	125	0.15	0.8	185	0.17	0.8	-	-	-	45	0.15	0.6	-	-	-
CCGT 120408ER-SI	T8330	0.8	205	0.23	1.0	120	0.21	1.0	190	0.23	1.0	-	-	-	50	0.21	0.8	-	-	-
	T8430	0.8	230	0.24	1.0	125	0.22	1.0	185	0.24	1.0	-	-	-	45	0.22	0.8	-	-	-

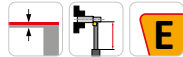

EL-SI geometria positiva sinistra per operazioni di finitura, taglio continuo.

CCGT 060202EL-SI	T8330	0.2	215	0.10	0.8	125	0.09	0.8	200	0.10	0.8	-	-	-	50	0.08	0.6	-	-	-
	T8430	0.2	260	0.10	0.8	140	0.09	0.8	215	0.10	0.8	-	-	-	55	0.08	0.6	-	-	-
CCGT 060204EL-SI	T8315	0.4	225	0.12	0.8	135	0.11	0.8	210	0.12	0.8	-	-	-	55	0.10	0.6	-	-	-
	T8330	0.4	215	0.12	0.8	125	0.11	0.8	200	0.12	0.8	-	-	-	50	0.10	0.6	-	-	-
	T8430	0.4	260	0.12	0.8	140	0.11	0.8	215	0.12	0.8	-	-	-	55	0.10	0.6	-	-	-
CCGT 09T304EL-SI	T8315	0.4	205	0.17	0.8	120	0.15	0.8	190	0.17	0.8	-	-	-	50	0.15	0.6	-	-	-
	T8330	0.4	195	0.17	0.8	115	0.15	0.8	185	0.17	0.8	-	-	-	45	0.15	0.6	-	-	-
	T8430	0.4	230	0.17	0.8	125	0.15	0.8	185	0.17	0.8	-	-	-	45	0.15	0.6	-	-	-
CCGT 120408EL-SI	T8330	0.8	205	0.23	1.0	120	0.21	1.0	190	0.23	1.0	-	-	-	50	0.21	0.8	-	-	-
	T8430	0.8	230	0.24	1.0	125	0.22	1.0	185	0.24	1.0	-	-	-	45	0.22	0.8	-	-	-



CCMT



	IC	D1	L	S
	(mm)	(mm)	(mm)	(mm)
0602	6.350	2.80	6.40	2.38
0803	7.940	3.40	8.10	3.18
09T3	9.525	4.40	9.70	3.97
1204	12.700	5.50	12.90	4.76

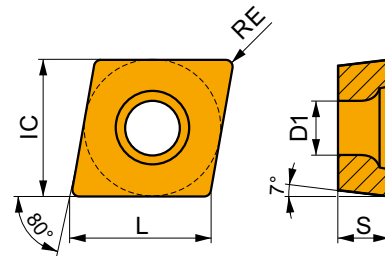

Idoneità e valori iniziali per velocità di taglio (Vc), avanzamento (f) e profondità di taglio (ap). Fare riferimento alla nostra App Machining Calculator per ulteriori calcoli.

Codice prodotto	RE	P			M			K			N			S			H		
		vc	f	ap	vc	f	ap	vc	f	ap	vc	f	ap	vc	f	ap	vc	f	ap
	(mm)	(m/min)	(mm/rev)	(mm)	(m/min)	(mm/rev)	(mm)	(m/min)	(mm/rev)	(mm)	(m/min)	(mm/rev)	(mm)	(m/min)	(mm/rev)	(mm)	(m/min)	(mm/rev)	(mm)

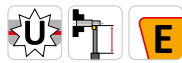
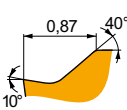

FF geometria positiva per operazioni da super finitura fino a finitura, da taglio continuo a leggermente interrotto.

CCMT 060202E-FF	T8315	0.2	195	0.10	1.0	115	0.09	1.0	-	-	-	-	-	-	-	-	-	-	-
	T8330	0.2	185	0.10	1.0	110	0.09	1.0	-	-	-	-	-	-	-	-	-	-	-
	T8430	0.2	230	0.10	1.0	125	0.09	1.0	-	-	-	-	-	-	-	-	-	-	-
	T9315	0.2	315	0.10	1.0	-	-	-	-	-	-	-	-	-	-	-	-	-	-
CCMT 060204E-FF	T8315	0.4	195	0.12	1.0	115	0.11	1.0	-	-	-	-	-	-	-	-	-	-	-
	T8330	0.4	185	0.12	1.0	110	0.11	1.0	-	-	-	-	-	-	-	-	-	-	-
	T8430	0.4	225	0.12	1.0	120	0.11	1.0	-	-	-	-	-	-	-	-	-	-	-
	T9315	0.4	310	0.12	1.0	-	-	-	-	-	-	-	-	-	-	-	-	-	-
CCMT 09T304E-FF	T8315	0.4	190	0.12	1.2	110	0.11	1.2	-	-	-	-	-	-	-	-	-	-	-
	T8330	0.4	185	0.12	1.2	110	0.11	1.2	-	-	-	-	-	-	-	-	-	-	-
	T8430	0.4	225	0.12	1.2	120	0.11	1.2	-	-	-	-	-	-	-	-	-	-	-
	T9315	0.4	300	0.12	1.2	-	-	-	-	-	-	-	-	-	-	-	-	-	-

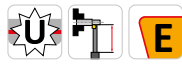
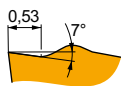

FF2 geometria positiva per operazioni da super finitura fino a finitura, da taglio continuo a leggermente interrotto.

CCMT 060202E-FF2	T7325	0.2	240	0.05	0.8	-	-	-	-	-	-	-	-	-	-	-	-	-	-
	T8330	0.2	205	0.05	0.8	190	0.05	0.8	-	-	-	-	-	-	-	-	-	-	-
	T8430	0.2	280	0.05	0.8	230	0.05	0.8	-	-	-	-	-	-	-	-	-	-	-
	T9315	0.2	390	0.05	0.8	370	0.05	0.8	-	-	-	-	-	-	-	-	-	-	-
	T9325	0.2	350	0.05	0.8	330	0.05	0.8	-	-	-	-	-	-	-	-	-	-	-
CCMT 060204E-FF2	TT010	0.2	345	0.05	0.5	-	-	-	-	-	-	-	-	-	-	-	-	-	-
	T7325	0.4	190	0.12	1.0	-	-	-	-	-	-	-	-	-	-	-	-	-	-
	T8330	0.4	165	0.12	1.0	155	0.12	1.0	-	-	-	-	-	-	-	-	-	-	-
	T8430	0.4	205	0.12	1.0	170	0.12	1.0	-	-	-	-	-	-	-	-	-	-	-
	T9315	0.4	280	0.12	1.0	265	0.12	1.0	-	-	-	-	-	-	-	-	-	-	-
	T9325	0.4	255	0.12	1.0	240	0.12	1.0	-	-	-	-	-	-	-	-	-	-	-
CCMT 080302E-FF2	TT010	0.4	215	0.12	1.0	-	-	-	-	-	-	-	-	-	-	-	-	-	-
	TT010	0.4	280	0.12	0.5	-	-	-	-	-	-	-	-	-	-	-	-	-	-
	T7325	0.2	240	0.05	0.8	-	-	-	-	-	-	-	-	-	-	-	-	-	-
	T8330	0.2	205	0.05	0.8	190	0.05	0.8	-	-	-	-	-	-	-	-	-	-	-
	T8430	0.2	280	0.05	0.8	230	0.05	0.8	-	-	-	-	-	-	-	-	-	-	-
CCMT 080304E-FF2	T9325	0.2	350	0.05	0.8	330	0.05	0.8	-	-	-	-	-	-	-	-	-	-	-
	TT010	0.2	345	0.05	0.5	-	-	-	-	-	-	-	-	-	-	-	-	-	-
	T7325	0.4	190	0.12	1.0	-	-	-	-	-	-	-	-	-	-	-	-	-	-
	T8330	0.4	165	0.12	1.0	155	0.12	1.0	-	-	-	-	-	-	-	-	-	-	-
	T8430	0.4	205	0.12	1.0	170	0.12	1.0	-	-	-	-	-	-	-	-	-	-	-



Idoneità e valori iniziali per velocità di taglio (Vc), avanzamento (f) e profondità di taglio (ap). Fare riferimento alla nostra App Machining Calculator per ulteriori calcoli.

Codice prodotto	RE  (mm)	P			M			K			N			S			H		
		vc (m/min)	f (mm/rev)	ap (mm)	vc (m/min)	f (mm/rev)	ap (mm)	vc (m/min)	f (mm/rev)	ap (mm)	vc (m/min)	f (mm/rev)	ap (mm)	vc (m/min)	f (mm/rev)	ap (mm)	vc (m/min)	f (mm/rev)	ap (mm)

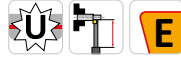
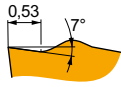

FF2 geometria positiva per operazioni da super finitura fino a finitura, da taglio continuo a leggermente interrotto.

CCMT 080308E-FF2	T7325	0.8	205	0.17	1.0	-	-	-	-	-	-	-	-	-	-	-	-	-
	T8330	0.8	180	0.17	1.0	-	-	-	170	0.17	1.0	-	-	-	-	-	-	-
	T8430	0.8	210	0.17	1.0	-	-	-	175	0.17	1.0	-	-	-	-	-	-	-
	T9325	0.8	260	0.17	1.0	-	-	-	245	0.17	1.0	-	-	-	-	-	-	-
CCMT 09T304E-FF2	T7325	0.4	190	0.12	1.2	-	-	-	-	-	-	-	-	-	-	-	-	-
	T8330	0.4	165	0.12	1.2	-	-	-	155	0.12	1.2	-	-	-	-	-	-	-
	T8430	0.4	200	0.12	1.2	-	-	-	165	0.12	1.2	-	-	-	-	-	-	-
	T9315	0.4	275	0.12	1.2	-	-	-	260	0.12	1.2	-	-	-	-	-	-	-
	T9325	0.4	250	0.12	1.2	-	-	-	235	0.12	1.2	-	-	-	-	-	-	-
	T9335	0.4	215	0.12	1.2	-	-	-	-	-	-	-	-	-	-	-	-	-
CCMT 09T308E-FF2	TT010	0.4	350	0.06	0.5	-	-	-	-	-	-	-	-	-	-	-	-	-
	T7325	0.8	205	0.17	1.2	-	-	-	-	-	-	-	-	-	-	-	-	-
	T8330	0.8	175	0.17	1.2	-	-	-	165	0.17	1.2	-	-	-	-	-	-	-
	T8430	0.8	205	0.17	1.2	-	-	-	170	0.17	1.2	-	-	-	-	-	-	-
	T9315	0.8	285	0.17	1.2	-	-	-	270	0.17	1.2	-	-	-	-	-	-	-
	T9325	0.8	255	0.17	1.2	-	-	-	240	0.17	1.2	-	-	-	-	-	-	-

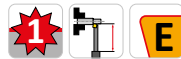

FM geometria per operazioni da finitura fino a semi sgrassatura, da taglio continuo a leggermente interrotto.

CCMT 060202E-FM	T7325	0.2	210	0.10	1.0	160	0.09	1.0	-	-	-	-	-	-	-	-	-
	T7335	0.2	210	0.10	1.0	160	0.09	1.0	-	-	-	-	-	-	-	-	-
	T8315	0.2	195	0.10	1.0	115	0.09	1.0	185	0.10	1.0	585	0.12	1.0	-	-	-
	T8330	0.2	185	0.10	1.0	110	0.09	1.0	175	0.10	1.0	555	0.12	1.0	-	-	-
	T8430	0.2	230	0.10	1.0	125	0.09	1.0	185	0.10	1.0	630	0.12	1.0	-	-	-
	T9315	0.2	315	0.10	1.0	-	-	-	295	0.10	1.0	-	-	-	-	-	-
CCMT 060204E-FM	T9325	0.2	285	0.10	1.0	170	0.09	1.0	270	0.10	1.0	-	-	-	-	-	-
	T7325	0.4	200	0.15	1.0	155	0.15	1.0	-	-	-	-	-	-	-	-	-
	T7335	0.4	195	0.15	1.0	150	0.15	1.0	-	-	-	-	-	-	-	-	-
	T8315	0.4	185	0.15	1.0	110	0.14	1.0	175	0.15	1.0	555	0.18	1.0	-	-	-
	T8330	0.4	170	0.15	1.0	100	0.14	1.0	160	0.15	1.0	510	0.18	1.0	-	-	-
	T8430	0.4	205	0.15	1.0	110	0.14	1.0	170	0.15	1.0	570	0.18	1.0	-	-	-
CCMT 060208E-FM	T9315	0.4	285	0.15	1.0	-	-	-	270	0.15	1.0	-	-	-	-	-	-
	T9325	0.4	250	0.15	1.0	150	0.15	1.0	235	0.15	1.0	-	-	-	-	-	-
	T7325	0.8	220	0.20	1.0	170	0.18	1.0	-	-	-	-	-	-	-	-	-
	T8330	0.8	190	0.20	1.0	110	0.18	1.0	180	0.20	1.0	570	0.24	1.0	-	-	-
	T8430	0.8	220	0.20	1.0	120	0.18	1.0	180	0.20	1.0	600	0.24	1.0	-	-	-
	T9315	0.8	300	0.20	1.0	-	-	-	285	0.20	1.0	-	-	-	-	-	-
CCMT 09T302E-FM	T9325	0.8	265	0.20	1.0	155	0.18	1.0	250	0.20	1.0	-	-	-	-	-	-
	T7325	0.2	205	0.10	1.2	155	0.09	1.2	-	-	-	-	-	-	-	-	-
	T7335	0.2	205	0.10	1.2	155	0.09	1.2	-	-	-	-	-	-	-	-	-
	T8315	0.2	190	0.10	1.2	110	0.09	1.2	180	0.10	1.2	570	0.12	1.2	-	-	-
	T8330	0.2	180	0.10	1.2	105	0.09	1.2	170	0.10	1.2	540	0.12	1.2	-	-	-
	T8430	0.2	225	0.10	1.2	120	0.09	1.2	185	0.10	1.2	615	0.12	1.2	-	-	-
CCMT 09T304E-FM	T9315	0.2	310	0.10	1.2	-	-	-	290	0.10	1.2	-	-	-	-	-	-
	T9325	0.2	275	0.10	1.2	165	0.09	1.2	260	0.10	1.2	-	-	-	-	-	-
	T7325	0.4	195	0.15	1.2	150	0.15	1.2	-	-	-	-	-	-	-	-	-
	T7335	0.4	190	0.15	1.2	145	0.15	1.2	-	-	-	-	-	-	-	-	-
	T8315	0.4	180	0.15	1.2	105	0.14	1.2	170	0.15	1.2	540	0.18	1.2	-	-	-
	T8330	0.4	170	0.15	1.2	100	0.14	1.2	160	0.15	1.2	510	0.18	1.2	-	-	-
CCMT 09T304E-FM	T8430	0.4	200	0.15	1.2	110	0.14	1.2	165	0.15	1.2	555	0.18	1.2	-	-	-
	T9315	0.4	275	0.15	1.2	-	-	-	260	0.15	1.2	-	-	-	-	-	-
	T9325	0.4	245	0.15	1.2	145	0.15	1.2	230	0.15	1.2	-	-	-	-	-	-



Idoneità e valori iniziali per velocità di taglio (Vc), avanzamento (f) e profondità di taglio (ap). Fare riferimento alla nostra App Machining Calculator per ulteriori calcoli.

Codice prodotto	RE (mm)	P			M			K			N			S			H		
		vc (m/min)	f (mm/rev)	ap (mm)	vc (m/min)	f (mm/rev)	ap (mm)	vc (m/min)	f (mm/rev)	ap (mm)	vc (m/min)	f (mm/rev)	ap (mm)	vc (m/min)	f (mm/rev)	ap (mm)	vc (m/min)	f (mm/rev)	ap (mm)

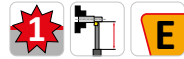
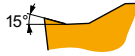

FM geometria per operazioni da finitura fino a semi sgrossatura, da taglio continuo a leggermente interrotto.

CCMT 09T308E-FM	T7325	0.8	215	0.20	1.2	165	0.18	1.2	-	-	-	-	-	-	-	-	-	-
	T7335	0.8	205	0.20	1.2	155	0.18	1.2	-	-	-	-	-	-	-	-	-	-
	T8315	0.8	195	0.20	1.2	115	0.18	1.2	185	0.20	1.2	585	0.24	1.2	-	-	-	-
	T8330	0.8	185	0.20	1.2	110	0.18	1.2	175	0.20	1.2	555	0.24	1.2	-	-	-	-
	T8430	0.8	210	0.20	1.2	115	0.18	1.2	175	0.20	1.2	585	0.24	1.2	-	-	-	-
	T9315	0.8	290	0.20	1.2	-	-	-	275	0.20	1.2	-	-	-	-	-	-	-
	T9325	0.8	260	0.20	1.2	155	0.18	1.2	245	0.20	1.2	-	-	-	-	-	-	-
CCMT 120404E-FM	T7325	0.4	190	0.15	1.7	145	0.15	1.7	-	-	-	-	-	-	-	-	-	-
	T7335	0.4	185	0.15	1.7	140	0.15	1.7	-	-	-	-	-	-	-	-	-	-
	T8315	0.4	170	0.15	1.7	100	0.14	1.7	160	0.15	1.7	510	0.18	1.7	-	-	-	-
	T8330	0.4	165	0.15	1.7	95	0.14	1.7	155	0.15	1.7	495	0.18	1.7	-	-	-	-
	T8430	0.4	195	0.15	1.7	105	0.14	1.7	160	0.15	1.7	540	0.18	1.7	-	-	-	-
	T9315	0.4	265	0.15	1.7	-	-	-	250	0.15	1.7	-	-	-	-	-	-	-
	T9325	0.4	240	0.15	1.7	140	0.15	1.7	225	0.15	1.7	-	-	-	-	-	-	-
CCMT 120408E-FM	T7325	0.8	205	0.20	1.7	155	0.18	1.7	-	-	-	-	-	-	-	-	-	-
	T7335	0.8	200	0.20	1.7	155	0.18	1.7	-	-	-	-	-	-	-	-	-	-
	T8315	0.8	190	0.20	1.7	110	0.18	1.7	180	0.20	1.7	570	0.24	1.7	-	-	-	-
	T8330	0.8	180	0.20	1.7	105	0.18	1.7	170	0.20	1.7	540	0.24	1.7	-	-	-	-
	T8430	0.8	205	0.20	1.7	110	0.18	1.7	170	0.20	1.7	570	0.24	1.7	-	-	-	-
	T9315	0.8	280	0.20	1.7	-	-	-	265	0.20	1.7	-	-	-	-	-	-	-
	T9325	0.8	250	0.20	1.7	150	0.18	1.7	235	0.20	1.7	-	-	-	-	-	-	-
CCMT 120412E-FM	T8330	1.2	175	0.27	1.7	105	0.24	1.7	165	0.27	1.7	525	0.32	1.7	-	-	-	-
	T8430	1.2	190	0.27	1.7	105	0.24	1.7	155	0.27	1.7	525	0.32	1.7	-	-	-	-
	T9325	1.2	235	0.27	1.7	140	0.24	1.7	220	0.27	1.7	-	-	-	-	-	-	

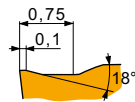

FM2 geometria per operazioni da finitura fino a lavorazioni medie, da taglio continuo a interrotto.

CCMT 080304E-FM2	T8330	0.4	165	0.12	1.0	95	0.11	1.0	155	0.12	1.0	-	-	-	-	-	-
	T8430	0.4	205	0.12	1.0	110	0.11	1.0	170	0.12	1.0	-	-	-	-	-	-
	T9315	0.4	280	0.12	1.0	-	-	-	265	0.12	1.0	-	-	-	-	-	-
	T9325	0.4	255	0.12	1.0	150	0.11	1.0	240	0.12	1.0	-	-	-	-	-	-
	T9335	0.4	215	0.12	1.0	125	0.11	1.0	-	-	-	-	-	-	-	-	-
CCMT 080308E-FM2	T8330	0.8	180	0.17	1.0	105	0.15	1.0	170	0.17	1.0	-	-	-	-	-	-
	T8430	0.8	210	0.17	1.0	115	0.15	1.0	175	0.17	1.0	-	-	-	-	-	-
	T9325	0.8	260	0.17	1.0	155	0.15	1.0	245	0.17	1.0	-	-	-	-	-	-
	T9335	0.8	225	0.17	1.0	135	0.15	1.0	-	-	-	-	-	-	-	-	-
CCMT 09T304E-FM2	T6310	0.4	165	0.12	1.0	115	0.11	1.0	130	0.12	1.0	-	-	-	-	-	-
	T8330	0.4	165	0.12	1.0	95	0.11	1.0	155	0.12	1.0	-	-	-	-	-	-
	T8430	0.4	205	0.12	1.0	110	0.11	1.0	170	0.12	1.0	-	-	-	-	-	-
	T9315	0.4	280	0.12	1.0	-	-	-	265	0.12	1.0	-	-	-	-	-	-
	T9325	0.4	255	0.12	1.0	150	0.11	1.0	240	0.12	1.0	-	-	-	-	-	-
CCMT 09T308E-FM2	T6310	0.8	180	0.17	1.0	125	0.15	1.0	145	0.17	1.0	-	-	-	-	-	-
	T7325	0.8	205	0.17	1.0	155	0.15	1.0	-	-	-	-	-	-	-	-	-
	T8330	0.8	180	0.17	1.0	105	0.15	1.0	170	0.17	1.0	-	-	-	-	-	-
	T8430	0.8	210	0.17	1.0	115	0.15	1.0	175	0.17	1.0	-	-	-	-	-	-
	T9315	0.8	290	0.17	1.0	-	-	-	275	0.17	1.0	-	-	-	-	-	-
	T9325	0.8	260	0.17	1.0	155	0.15	1.0	245	0.17	1.0	-	-	-	-	-	-
CCMT 120408E-FM2	T7325	0.8	190	0.20	1.5	145	0.18	1.5	-	-	-	-	-	-	-	-	-
	T8330	0.8	165	0.20	1.5	95	0.18	1.5	155	0.20	1.5	-	-	-	-	-	-
	T8430	0.8	190	0.20	1.5	105	0.18	1.5	155	0.20	1.5	-	-	-	-	-	-
	T9325	0.8	235	0.20	1.5	140	0.18	1.5	220	0.20	1.5	-	-	-	-	-	-
	T9335	0.8	200	0.20	1.5	120	0.18	1.5	-	-	-	-	-	-	-	-	-



Idoneità e valori iniziali per velocità di taglio (Vc), avanzamento (f) e profondità di taglio (ap). Fare riferimento alla nostra App Machining Calculator per ulteriori calcoli.

Codice prodotto	RE  (mm)	P			M			K			N			S			H		
		vc	f	ap	vc	f	ap	vc	f	ap	vc	f	ap	vc	f	ap	vc	f	ap
		(m/min)	(mm/rev)	(mm)	(m/min)	(mm/rev)	(mm)	(m/min)	(mm/rev)	(mm)	(m/min)	(mm/rev)	(mm)	(m/min)	(mm/rev)	(mm)	(m/min)	(mm/rev)	(mm)

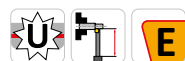
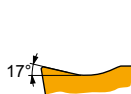

NF2 geometria con design positivo per operazioni da finitura e semi sgrossatura, taglio continuo.

CCMT 060202E-NF2	T6310	0.2	170	0.10	0.8	120	0.09	0.8	135	0.10	0.8	510	0.12	0.8	50	0.08	0.6	-	-	-
	T7325	0.2	195	0.10	0.8	150	0.09	0.8	-	-	-	-	-	-	60	0.08	0.6	-	-	-
	T8330	0.2	170	0.10	0.8	100	0.09	0.8	160	0.10	0.8	510	0.12	0.8	40	0.08	0.6	-	-	-
	T8430	0.2	210	0.10	0.8	115	0.09	0.8	175	0.10	0.8	585	0.12	0.8	45	0.08	0.6	-	-	-
	T9325	0.2	260	0.10	0.8	155	0.09	0.8	245	0.10	0.8	-	-	-	55	0.08	0.6	-	-	-
CCMT 060204E-NF2	H07	0.4	-	-	-	85	0.11	0.8	140	0.12	0.8	445	0.14	0.8	45	0.11	0.6	-	-	-
	T6310	0.4	170	0.12	0.8	120	0.11	0.8	135	0.12	0.8	510	0.14	0.8	50	0.11	0.6	-	-	-
	T7325	0.4	200	0.12	0.8	155	0.11	0.8	-	-	-	-	-	65	0.11	0.6	-	-	-	
	T8330	0.4	170	0.12	0.8	100	0.11	0.8	160	0.12	0.8	510	0.14	0.8	40	0.11	0.6	-	-	-
	T8430	0.4	205	0.12	0.8	110	0.11	0.8	170	0.12	0.8	570	0.14	0.8	45	0.11	0.6	-	-	-
	T9315	0.4	290	0.12	0.8	-	-	-	275	0.12	0.8	-	-	-	-	-	-	-	-	-
	T9325	0.4	255	0.12	0.8	150	0.11	0.8	240	0.12	0.8	-	-	-	55	0.11	0.6	-	-	-
	T9335	0.4	220	0.12	0.8	130	0.11	0.8	-	-	-	-	-	45	0.11	0.6	-	-	-	-
CCMT 080304E-NF2	T5315	0.4	280	0.12	1.0	-	-	-	265	0.12	1.0	-	-	-	-	-	-	-	-	-
	T7325	0.4	190	0.12	1.0	145	0.11	1.0	-	-	-	-	-	60	0.11	0.8	-	-	-	
	T7335	0.4	190	0.12	1.0	145	0.11	1.0	-	-	-	-	-	60	0.11	0.8	-	-	-	
	T9315	0.4	280	0.12	1.0	-	-	-	265	0.12	1.0	-	-	-	-	-	-	-	-	-
	T9325	0.4	255	0.12	1.0	150	0.11	1.0	240	0.12	1.0	-	-	-	55	0.11	0.8	-	-	-
	T9335	0.4	215	0.12	1.2	125	0.11	1.2	-	-	-	-	-	45	0.11	1.0	-	-	-	-
CCMT 080308E-NF2	H07	0.8	-	-	-	95	0.13	1.2	150	0.14	1.2	485	0.17	1.2	45	0.13	1.0	-	-	-
	T5315	0.8	295	0.17	1.0	-	-	-	280	0.17	1.0	-	-	-	-	-	-	-	-	-
	T7325	0.8	205	0.17	1.0	155	0.15	1.0	-	-	-	-	-	65	0.14	0.8	-	-	-	
	T7335	0.8	205	0.17	1.0	155	0.15	1.0	-	-	-	-	-	65	0.14	0.8	-	-	-	
	T9325	0.8	260	0.17	1.0	155	0.15	1.0	245	0.17	1.0	-	-	-	55	0.14	0.8	-	-	-
CCMT 09T304E-NF2	H07	0.4	-	-	-	85	0.11	1.2	135	0.12	1.2	430	0.14	1.2	40	0.11	1.0	-	-	-
	T6310	0.4	165	0.12	1.2	115	0.11	1.2	130	0.12	1.2	495	0.14	1.2	45	0.11	1.0	-	-	-
	T7325	0.4	190	0.12	1.2	145	0.11	1.2	-	-	-	-	-	60	0.11	1.0	-	-	-	
	T8330	0.4	165	0.12	1.2	95	0.11	1.2	155	0.12	1.2	495	0.14	1.2	40	0.11	1.0	-	-	-
	T8430	0.4	200	0.12	1.2	110	0.11	1.2	165	0.12	1.2	555	0.14	1.2	40	0.11	1.0	-	-	-
	T9315	0.4	275	0.12	1.2	-	-	-	260	0.12	1.2	-	-	-	-	-	-	-	-	-
	T9325	0.4	250	0.12	1.2	150	0.11	1.2	235	0.12	1.2	-	-	-	55	0.11	1.0	-	-	-
	T9335	0.4	215	0.12	1.2	125	0.11	1.2	-	-	-	-	-	45	0.11	1.0	-	-	-	-
	CCMT 09T308E-NF2	H07	0.8	-	-	-	95	0.13	1.2	150	0.14	1.2	485	0.17	1.2	45	0.13	1.0	-	-
T6310		0.8	190	0.14	1.2	135	0.13	1.2	150	0.14	1.2	570	0.17	1.2	55	0.13	1.0	-	-	-
T7325		0.8	215	0.14	1.2	165	0.13	1.2	-	-	-	-	-	65	0.13	1.0	-	-	-	
T8330		0.8	190	0.14	1.2	110	0.13	1.2	180	0.14	1.2	570	0.17	1.2	45	0.13	1.0	-	-	-
T8430		0.8	225	0.14	1.2	120	0.13	1.2	185	0.14	1.2	615	0.17	1.2	45	0.13	1.0	-	-	-
T9315		0.8	310	0.14	1.2	-	-	-	290	0.14	1.2	-	-	-	-	-	-	-	-	-
T9325		0.8	275	0.14	1.2	165	0.13	1.2	260	0.14	1.2	-	-	-	60	0.13	1.0	-	-	-
T9335		0.8	235	0.14	1.2	140	0.13	1.2	-	-	-	-	-	50	0.13	1.0	-	-	-	-



I.C.	R
6,35	1,0
9,525	1,5
12,7	2,5



RF geometria per operazioni da semi sgrossatura fino a sgrossatura, da taglio continuo a interrotto.

CCMT 060202E-RF	T7335	0.2	150	0.15	1.0	115	0.14	1.0	-	-	-	-	-	-	-	-	-	-	-	
CCMT 060204E-RF	T5315	0.4	235	0.15	1.0	-	-	-	220	0.15	1.0	-	-	-	45	0.15	1.0	-	-	-
	T7335	0.4	160	0.15	1.0	120	0.15	1.0	-	-	-	-	-	-	-	-	-	-	-	
	T9325	0.4	205	0.15	1.0	120	0.15	1.0	190	0.15	1.0	-	-	-	-	-	-	-	-	
CCMT 09T304E-RF	T7335	0.4	135	0.20	1.5	105	0.18	1.5	-	-	-	-	-	-	-	-	-	-	-	
	T9325	0.4	175	0.20	1.5	105	0.18	1.5	165	0.20	1.5	-	-	-	-	-	-	-	-	
CCMT 09T308E-RF	T5315	0.8	245	0.20	1.5	-	-	-	230	0.20	1.5	-	-	-	45	0.15	1.0	-	-	-
	T7335	0.8	165	0.20	1.5	125	0.18	1.5	-	-	-	-	-	-	-	-	-	-	-	
	T9325	0.8	210	0.20	1.5	125	0.18	1.5	195	0.20	1.5	-	-	-	-	-	-	-	-	
CCMT 120408E-RF	T5315	0.8	230	0.22	2.2	-	-	-	215	0.22	2.2	-	-	-	45	0.15	1.0	-	-	-
	T7335	0.8	150	0.22	2.2	115	0.22	2.2	-	-	-	-	-	-	-	-	-	-	-	
	T9325	0.8	195	0.22	2.2	115	0.22	2.2	185	0.22	2.2	-	-	-	-	-	-	-	-	



Idoneità e valori iniziali per velocità di taglio (Vc), avanzamento (f) e profondità di taglio (ap). Fare riferimento alla nostra App Machining Calculator per ulteriori calcoli.

Codice prodotto	RE (mm)	P			M			K			N			S			H		
		vc (m/min)	f (mm/rev)	ap (mm)	vc (m/min)	f (mm/rev)	ap (mm)	vc (m/min)	f (mm/rev)	ap (mm)	vc (m/min)	f (mm/rev)	ap (mm)	vc (m/min)	f (mm/rev)	ap (mm)	vc (m/min)	f (mm/rev)	ap (mm)

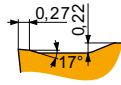
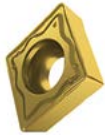

RM geometria per operazioni da semi sgrossatura fino a sgrossatura, da taglio continuo a interrotto.

CCMT 09T304E-RM	T5305	0.4	260	0.27	2.2	-	-	-	245	0.27	2.2	-	-	-	-	-	-	50	0.15	1.0
	T5315	0.4	230	0.27	2.2	-	-	-	215	0.27	2.2	-	-	-	-	-	-	45	0.15	1.0
	T7335	0.4	155	0.27	2.2	120	0.24	2.2	-	-	-	50	0.19	1.8	-	-	-	-	-	-
	T8330	0.4	140	0.27	2.2	80	0.24	2.2	130	0.27	2.2	-	-	-	35	0.19	1.8	25	0.15	1.0
	T8430	0.4	150	0.27	2.2	80	0.24	2.2	125	0.27	2.2	-	-	-	30	0.19	1.8	25	0.15	1.0
	T9315	0.4	215	0.27	2.2	-	-	-	200	0.27	2.2	-	-	-	-	-	-	40	0.15	1.0
	T9325	0.4	190	0.27	2.2	110	0.24	2.2	180	0.27	2.2	-	-	-	40	0.19	1.8	-	-	-
CCMT 09T308E-RM	T5305	0.8	290	0.30	2.2	-	-	-	275	0.30	2.2	-	-	-	-	-	-	55	0.15	1.0
	T5315	0.8	265	0.30	2.2	-	-	-	250	0.30	2.2	-	-	-	-	-	-	50	0.15	1.0
	T7335	0.8	175	0.30	2.2	135	0.27	2.2	-	-	-	55	0.24	1.8	-	-	-	-	-	
	T8330	0.8	165	0.30	2.2	95	0.27	2.2	155	0.30	2.2	-	-	-	40	0.24	1.8	30	0.15	1.0
	T8430	0.8	180	0.30	2.2	95	0.27	2.2	145	0.30	2.2	-	-	-	35	0.24	1.8	30	0.15	1.0
	T9315	0.8	240	0.30	2.2	-	-	-	225	0.30	2.2	-	-	-	-	-	-	45	0.15	1.0
	T9325	0.8	215	0.30	2.2	125	0.27	2.2	200	0.30	2.2	-	-	-	45	0.24	1.8	-	-	-
CCMT 120408E-RM	T5305	0.8	290	0.30	2.7	-	-	-	275	0.30	2.7	-	-	-	-	-	-	55	0.15	1.0
	T5315	0.8	260	0.30	2.7	-	-	-	245	0.30	2.7	-	-	-	-	-	-	50	0.15	1.0
	T7335	0.8	175	0.30	2.7	135	0.27	2.7	-	-	-	55	0.24	2.2	-	-	-	-	-	
	T8330	0.8	160	0.30	2.7	95	0.27	2.7	150	0.30	2.7	-	-	-	40	0.24	2.2	30	0.15	1.0
	T8430	0.8	175	0.30	2.7	95	0.27	2.7	140	0.30	2.7	-	-	-	35	0.24	2.2	30	0.15	1.0
	T9315	0.8	235	0.30	2.7	-	-	-	220	0.30	2.7	-	-	-	-	-	-	45	0.15	1.0
	T9325	0.8	210	0.30	2.7	125	0.27	2.7	195	0.30	2.7	-	-	-	45	0.24	2.2	-	-	-
CCMT 120412E-RM	T8330	1.2	165	0.33	2.7	95	0.30	2.7	155	0.33	2.7	-	-	-	40	0.23	2.2	30	0.15	1.0
	T8430	1.2	180	0.33	2.7	95	0.30	2.7	145	0.33	2.7	-	-	-	35	0.23	2.2	30	0.15	1.0
	T9315	1.2	235	0.33	2.7	-	-	-	220	0.33	2.7	-	-	-	-	-	-	45	0.15	1.0
	T9325	1.2	215	0.33	2.7	125	0.30	2.7	200	0.33	2.7	-	-	-	45	0.23	2.2	-	-	-

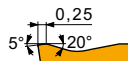

RM3 geometria per operazioni da semi sgrossatura fino a sgrossatura, da taglio continuo a interrotto.

CCMT 120404E-RM3	T7325	0.4	140	0.25	2.5	105	0.25	2.5	-	-	-	-	-	-	-	-	-	-	-	
	T9315	0.4	190	0.25	2.5	-	-	-	180	0.25	2.5	-	-	-	-	-	-	35	0.15	1.0
	T9325	0.4	165	0.25	2.5	95	0.25	2.5	155	0.25	2.5	-	-	-	-	-	-	-	-	
CCMT 120408E-RM3	T6310	0.8	145	0.27	2.5	100	0.27	2.5	115	0.27	2.5	-	-	-	-	-	-	25	0.15	1.0
	T7325	0.8	165	0.27	2.5	125	0.27	2.5	-	-	-	-	-	-	-	-	-	-	-	
	T9315	0.8	215	0.27	2.5	-	-	-	200	0.27	2.5	-	-	-	-	-	-	40	0.15	1.0
	T9325	0.8	195	0.27	2.5	115	0.27	2.5	185	0.27	2.5	-	-	-	-	-	-	-	-	
CCMT 120412E-RM3	T7325	1.2	170	0.30	2.5	130	0.27	2.5	-	-	-	-	-	-	-	-	-	-	-	
	T9315	1.2	220	0.30	2.5	-	-	-	205	0.30	2.5	-	-	-	-	-	-	40	0.15	1.0

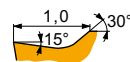

UR geometria per lavorazioni leggere e finitura, da taglio continuo a leggermente interrotto.

CCMT 060202E-UR	T7325	0.2	185	0.10	0.8	140	0.09	0.8	-	-	-	-	-	-	-	-	-	-	-	
	T7335	0.2	185	0.10	0.8	140	0.09	0.8	-	-	-	-	-	-	-	-	-	-	-	
	T8315	0.2	170	0.10	0.8	100	0.09	0.8	160	0.10	0.8	-	-	-	-	-	-	-	-	
	T8330	0.2	160	0.10	0.8	95	0.09	0.8	150	0.10	0.8	-	-	-	-	-	-	-	-	
	T8430	0.2	200	0.10	0.8	110	0.09	0.8	165	0.10	0.8	-	-	-	-	-	-	-	-	
	T9315	0.2	275	0.10	0.8	-	-	-	260	0.10	0.8	-	-	-	-	-	-	-	-	-
	T9325	0.2	250	0.10	0.8	150	0.09	0.8	235	0.10	0.8	-	-	-	-	-	-	-	-	-
	TT310	0.2	275	0.10	0.5	165	0.09	0.5	-	-	-	-	-	-	-	-	-	-	-	-



Idoneità e valori iniziali per velocità di taglio (Vc), avanzamento (f) e profondità di taglio (ap). Fare riferimento alla nostra App Machining Calculator per ulteriori calcoli.

Codice prodotto	RE  (mm)	P			M			K			N			S			H		
		vc (m/min)	f (mm/rev)	ap (mm)	vc (m/min)	f (mm/rev)	ap (mm)	vc (m/min)	f (mm/rev)	ap (mm)	vc (m/min)	f (mm/rev)	ap (mm)	vc (m/min)	f (mm/rev)	ap (mm)	vc (m/min)	f (mm/rev)	ap (mm)

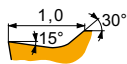

UR geometria per lavorazioni leggere e finitura, da taglio continuo a leggermente interrotto.

CCMT 060204E-UR	T5315	0.4	245	0.15	1.0	-	-	-	230	0.15	1.0	-	-	-	-	-	-	-	-	
	T7325	0.4	170	0.15	1.0	130	0.15	1.0	-	-	-	-	-	-	-	-	-	-	-	
	T7335	0.4	170	0.15	1.0	130	0.15	1.0	-	-	-	-	-	-	-	-	-	-	-	
	T8315	0.4	160	0.15	1.0	95	0.14	1.0	150	0.15	1.0	-	-	-	-	-	-	-	-	
	T8330	0.4	150	0.15	1.0	90	0.14	1.0	140	0.15	1.0	-	-	-	-	-	-	-	-	
	T8430	0.4	175	0.15	1.0	95	0.14	1.0	140	0.15	1.0	-	-	-	-	-	-	-	-	-
	T9315	0.4	245	0.15	1.0	-	-	-	230	0.15	1.0	-	-	-	-	-	-	-	-	-
	T9325	0.4	215	0.15	1.0	125	0.15	1.0	200	0.15	1.0	-	-	-	-	-	-	-	-	-
	TT310	0.4	255	0.15	0.5	150	0.14	0.5	-	-	-	-	-	-	-	-	-	-	-	-
	CCMT 060208E-UR	T5315	0.8	270	0.20	1.0	-	-	-	255	0.20	1.0	-	-	-	-	-	-	-	-
T7325		0.8	190	0.20	1.0	145	0.18	1.0	-	-	-	-	-	-	-	-	-	-	-	
T8330		0.8	165	0.20	1.0	95	0.18	1.0	155	0.20	1.0	-	-	-	-	-	-	-	-	
T8430		0.8	185	0.20	1.0	100	0.18	1.0	150	0.20	1.0	-	-	-	-	-	-	-	-	
T9315		0.8	255	0.20	1.0	-	-	-	240	0.20	1.0	-	-	-	-	-	-	-	-	-
CCMT 09T302E-UR	T6310	0.2	160	0.10	1.0	115	0.09	1.0	125	0.10	1.0	-	-	-	-	-	-	-	-	
	T8430	0.2	195	0.10	1.0	105	0.09	1.0	160	0.10	1.0	-	-	-	-	-	-	-	-	
	TT310	0.2	255	0.10	1.0	150	0.09	1.0	-	-	-	-	-	-	-	-	-	-	-	
CCMT 09T304E-UR	T5315	0.4	245	0.15	1.2	-	-	-	230	0.15	1.2	-	-	-	-	-	-	-	-	
	T7325	0.4	170	0.15	1.2	130	0.15	1.2	-	-	-	-	-	-	-	-	-	-	-	
	T7335	0.4	165	0.15	1.2	125	0.15	1.2	-	-	-	-	-	-	-	-	-	-	-	
	T8315	0.4	155	0.15	1.2	90	0.14	1.2	145	0.15	1.2	-	-	-	-	-	-	-	-	
	T8330	0.4	150	0.15	1.2	90	0.14	1.2	140	0.15	1.2	-	-	-	-	-	-	-	-	
	T8430	0.4	175	0.15	1.2	95	0.14	1.2	140	0.15	1.2	-	-	-	-	-	-	-	-	
	T9310	0.4	265	0.15	1.2	-	-	-	250	0.15	1.2	-	-	-	-	-	-	-	-	
	T9315	0.4	235	0.15	1.2	-	-	-	220	0.15	1.2	-	-	-	-	-	-	-	-	
	T9325	0.4	215	0.15	1.2	125	0.15	1.2	200	0.15	1.2	-	-	-	-	-	-	-	-	
	TT310	0.4	235	0.15	1.2	140	0.14	1.2	-	-	-	-	-	-	-	-	-	-	-	
CCMT 09T308E-UR	T5315	0.8	265	0.20	1.2	-	-	-	250	0.20	1.2	-	-	-	-	-	-	-	-	
	T7325	0.8	185	0.20	1.2	140	0.18	1.2	-	-	-	-	-	-	-	-	-	-	-	
	T7335	0.8	175	0.20	1.2	135	0.18	1.2	-	-	-	-	-	-	-	-	-	-	-	
	T8315	0.8	170	0.20	1.2	100	0.18	1.2	160	0.20	1.2	-	-	-	-	-	-	-	-	
	T8330	0.8	160	0.20	1.2	95	0.18	1.2	150	0.20	1.2	-	-	-	-	-	-	-	-	
	T8430	0.8	185	0.20	1.2	100	0.18	1.2	150	0.20	1.2	-	-	-	-	-	-	-	-	
	T9310	0.8	280	0.20	1.2	-	-	-	265	0.20	1.2	-	-	-	-	-	-	-	-	
	T9315	0.8	250	0.20	1.2	-	-	-	235	0.20	1.2	-	-	-	-	-	-	-	-	
	T9325	0.8	225	0.20	1.2	135	0.18	1.2	210	0.20	1.2	-	-	-	-	-	-	-	-	
	TT310	0.8	255	0.20	1.2	150	0.18	1.2	-	-	-	-	-	-	-	-	-	-	-	
CCMT 120404E-UR	T5315	0.4	235	0.15	1.7	-	-	-	220	0.15	1.7	-	-	-	-	-	-	-	-	
	T7325	0.4	160	0.15	1.7	120	0.15	1.7	-	-	-	-	-	-	-	-	-	-	-	
	T8330	0.4	140	0.15	1.7	80	0.14	1.7	130	0.15	1.7	-	-	-	-	-	-	-	-	
	T8430	0.4	170	0.15	1.7	90	0.14	1.7	135	0.15	1.7	-	-	-	-	-	-	-	-	
	T9315	0.4	230	0.15	1.7	-	-	-	215	0.15	1.7	-	-	-	-	-	-	-	-	
CCMT 120408E-UR	T9325	0.4	205	0.15	1.7	120	0.15	1.7	190	0.15	1.7	-	-	-	-	-	-	-	-	
	T5315	0.8	255	0.20	1.7	-	-	-	240	0.20	1.7	-	-	-	-	-	-	-	-	
	T7325	0.8	175	0.20	1.7	135	0.18	1.7	-	-	-	-	-	-	-	-	-	-	-	
	T7335	0.8	170	0.20	1.7	130	0.18	1.7	-	-	-	-	-	-	-	-	-	-	-	
	T8330	0.8	155	0.20	1.7	90	0.18	1.7	145	0.20	1.7	-	-	-	-	-	-	-	-	
	T8430	0.8	180	0.20	1.7	95	0.18	1.7	145	0.20	1.7	-	-	-	-	-	-	-	-	
	T9315	0.8	240	0.20	1.7	-	-	-	225	0.20	1.7	-	-	-	-	-	-	-	-	
CCMT 120412E-UR	T9325	0.8	215	0.20	1.7	125	0.18	1.7	200	0.20	1.7	-	-	-	-	-	-	-	-	
	T5315	1.2	240	0.27	1.7	-	-	-	225	0.27	1.7	-	-	-	-	-	-	-	-	
	T7325	1.2	170	0.27	1.7	130	0.24	1.7	-	-	-	-	-	-	-	-	-	-	-	
	T8430	1.2	165	0.27	1.7	90	0.24	1.7	135	0.27	1.7	-	-	-	-	-	-	-	-	
	T9315	1.2	225	0.27	1.7	-	-	-	210	0.27	1.7	-	-	-	-	-	-	-	-	
T9325	1.2	205	0.27	1.7	120	0.24	1.7	190	0.27	1.7	-	-	-	-	-	-	-	-		



Idoneità e valori iniziali per velocità di taglio (Vc), avanzamento (f) e profondità di taglio (ap). Fare riferimento alla nostra App Machining Calculator per ulteriori calcoli.

Codice prodotto	RE (mm)	P			M			K			N			S			H		
		vc (m/min)	f (mm/rev)	ap (mm)	vc (m/min)	f (mm/rev)	ap (mm)	vc (m/min)	f (mm/rev)	ap (mm)	vc (m/min)	f (mm/rev)	ap (mm)	vc (m/min)	f (mm/rev)	ap (mm)	vc (m/min)	f (mm/rev)	ap (mm)

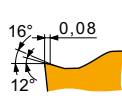
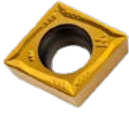

W-FM geometria wiper per lavorazioni leggere e finitura con maggiore velocità di avanzamento e finitura superficiale ottimizzata.

CCMT 060204W-FM	T7325	0.4	165	0.30	0.8	125	0.27	0.8	-	-	-	-	-	-	-	-	-	-
	T8430	0.4	165	0.30	0.8	90	0.27	0.8	135	0.30	0.8	-	-	-	-	-	-	-
	T9315	0.4	215	0.30	0.8	-	-	-	200	0.30	0.8	-	-	-	-	-	-	-
	T9325	0.4	190	0.30	0.8	110	0.27	0.8	180	0.30	0.8	-	-	-	-	-	-	-
CCMT 09T304W-FM	T7325	0.4	165	0.30	0.8	125	0.27	0.8	-	-	-	-	-	-	-	-	-	-
	T8330	0.4	145	0.30	0.8	85	0.27	0.8	135	0.30	0.8	-	-	-	-	-	-	-
	T8430	0.4	165	0.30	0.8	90	0.27	0.8	135	0.30	0.8	-	-	-	-	-	-	-
	T9315	0.4	215	0.30	0.8	-	-	-	200	0.30	0.8	-	-	-	-	-	-	-
CCMT 09T308W-FM	T9325	0.4	190	0.30	0.8	110	0.27	0.8	180	0.30	0.8	-	-	-	-	-	-	-
	T8330	0.8	155	0.40	1.0	90	0.36	1.0	145	0.40	1.0	-	-	-	-	-	-	-
	T8430	0.8	170	0.40	1.0	90	0.36	1.0	135	0.40	1.0	-	-	-	-	-	-	-
	T9315	0.8	220	0.40	1.0	-	-	-	205	0.40	1.0	-	-	-	-	-	-	-
T9325	0.8	200	0.40	1.0	120	0.36	1.0	190	0.40	1.0	-	-	-	-	-	-	-	

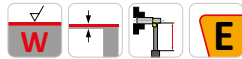
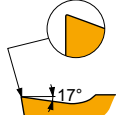
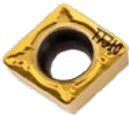

W-UR geometria wiper per lavorazioni leggere e finitura con maggiore velocità di avanzamento e finitura superficiale ottimizzata.

CCMT 060204W-UR	TT310	0.4	255	0.15	0.5	150	0.14	0.5	-	-	-	-	-	-	-	-	-
CCMT 09T308W-UR	TT310	0.8	255	0.20	1.2	150	0.18	1.2	-	-	-	-	-	-	-	-	-

CCMW



	IC (mm)	D1 (mm)	L (mm)	S (mm)
0602	6.350	2.80	6.40	2.38
09T3	9.525	4.40	9.70	3.97
1204	12.700	5.50	12.90	4.76

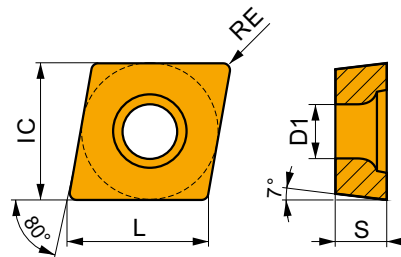

Idoneità e valori iniziali per velocità di taglio (Vc), avanzamento (f) e profondità di taglio (ap). Fare riferimento alla nostra App Machining Calculator per ulteriori calcoli.

Codice prodotto	RE (mm)	P			M			K			N			S			H		
		vc (m/min)	f (mm/rev)	ap (mm)	vc (m/min)	f (mm/rev)	ap (mm)	vc (m/min)	f (mm/rev)	ap (mm)	vc (m/min)	f (mm/rev)	ap (mm)	vc (m/min)	f (mm/rev)	ap (mm)	vc (m/min)	f (mm/rev)	ap (mm)

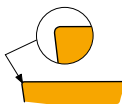

Adatta per operazioni da finitura fino a semi grossatura, da taglio continuo a leggermente interrotto.

CCMW 060202	T5305	0.2	-	-	-	-	-	-	230	0.08	2.0	-	-	-	-	-	45	0.15	1.0
	T6310	0.2	-	-	-	-	-	-	100	0.08	2.0	-	-	-	-	-	25	0.15	1.0
CCMW 060204	T5305	0.4	-	-	-	-	-	-	230	0.10	2.0	-	-	-	-	-	45	0.15	1.0
	T5315	0.4	-	-	-	-	-	-	195	0.10	2.0	-	-	-	-	-	40	0.15	1.0
	T6310	0.4	-	-	-	-	-	-	95	0.10	2.0	-	-	-	-	-	20	0.15	1.0
CCMW 09T304	T5305	0.4	-	-	-	-	-	-	215	0.10	3.0	-	-	-	-	-	45	0.15	1.0
	T5315	0.4	-	-	-	-	-	-	190	0.10	3.0	-	-	-	-	-	40	0.15	1.0
	T6310	0.4	-	-	-	-	-	-	95	0.10	3.0	-	-	-	-	-	20	0.15	1.0
CCMW 09T308	T5305	0.8	-	-	-	-	-	-	200	0.20	3.0	-	-	-	-	-	40	0.15	1.0
	T5315	0.8	-	-	-	-	-	-	180	0.20	3.0	-	-	-	-	-	35	0.15	1.0
	T6310	0.8	-	-	-	-	-	-	90	0.20	3.0	-	-	-	-	-	20	0.15	1.0



Idoneità e valori iniziali per velocità di taglio (Vc), avanzamento (f) e profondità di taglio (ap). Fare riferimento alla nostra App Machining Calculator per ulteriori calcoli.

Codice prodotto	RE (mm)	P			M			K			N			S			H		
		vc (m/min)	f (mm/rev)	ap (mm)	vc (m/min)	f (mm/rev)	ap (mm)	vc (m/min)	f (mm/rev)	ap (mm)	vc (m/min)	f (mm/rev)	ap (mm)	vc (m/min)	f (mm/rev)	ap (mm)	vc (m/min)	f (mm/rev)	ap (mm)
	T5305	0.4	–	–	–	–	–	–	–	–	–	–	–	–	–	–	–	–	–
	T5315	0.4	–	–	–	–	–	–	–	–	–	–	–	–	–	–	–	–	–
	T6310	0.4	–	–	–	–	–	–	–	–	–	–	–	–	–	–	–	–	–
CCMW 120408	T5305	0.8	–	–	–	–	–	–	–	–	–	–	–	–	–	–	–	–	–
	T5315	0.8	–	–	–	–	–	–	–	–	–	–	–	–	–	–	–	–	–
	T6310	0.8	–	–	–	–	–	–	–	–	–	–	–	–	–	–	–	–	–



Adatta per operazioni da finitura fino a semi sgrossatura, da taglio continuo a leggermente interrotto.

CCGW CBN

PRAMET

	IC (mm)	D1 (mm)	L (mm)	S (mm)
0602	6.350	2.80	6.50	2.38
09T3	9.525	4.50	9.70	3.97

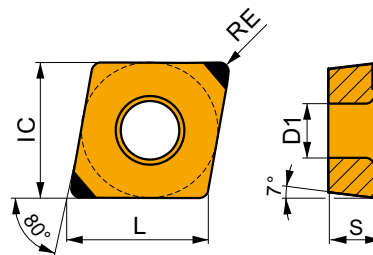

Idoneità e valori iniziali per velocità di taglio (Vc), avanzamento (f) e profondità di taglio (ap). Fare riferimento alla nostra App Machining Calculator per ulteriori calcoli.

Codice prodotto	RE (mm)	P			M			K			N			S			H		
		vc (m/min)	f (mm/rev)	ap (mm)	vc (m/min)	f (mm/rev)	ap (mm)	vc (m/min)	f (mm/rev)	ap (mm)	vc (m/min)	f (mm/rev)	ap (mm)	vc (m/min)	f (mm/rev)	ap (mm)	vc (m/min)	f (mm/rev)	ap (mm)
	TB310	0.4	–	–	–	–	–	–	–	–	–	–	–	–	–	–	–	–	–
	CCGW 09T304E-B	TB310	0.4	–	–	–	–	–	–	–	–	–	–	–	–	–	–	–	–
	TB310	0.4	–	–	–	–	–	–	–	–	–	–	–	–	–	–	–	–	–
	CCGW 09T304S01020B	TB310	0.4	–	–	–	–	–	–	–	–	–	–	–	–	–	–	–	–



Adatta per operazioni di finitura.



Adatta per operazioni di finitura.



SCAC(RL) EXT

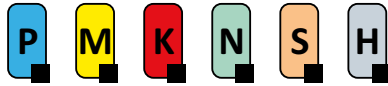

PRAMET

S



Utensile esterno, bloccaggio a vite, inserti CC... angolo del tagliente utensile 90°

Utensile di tornitura esterna destro/sinistro con bloccaggio a vite, angolo del tagliente utensile 90° per inserti positivi CC...06 o 09. Adatto per operazioni di tornitura longitudinale, conicità e smussi. Disponibile con stelo da 08x08 a 16x16 mm. Corpo trattato per una maggiore durata.

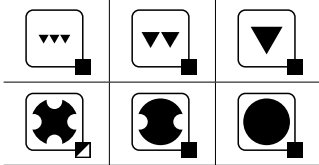
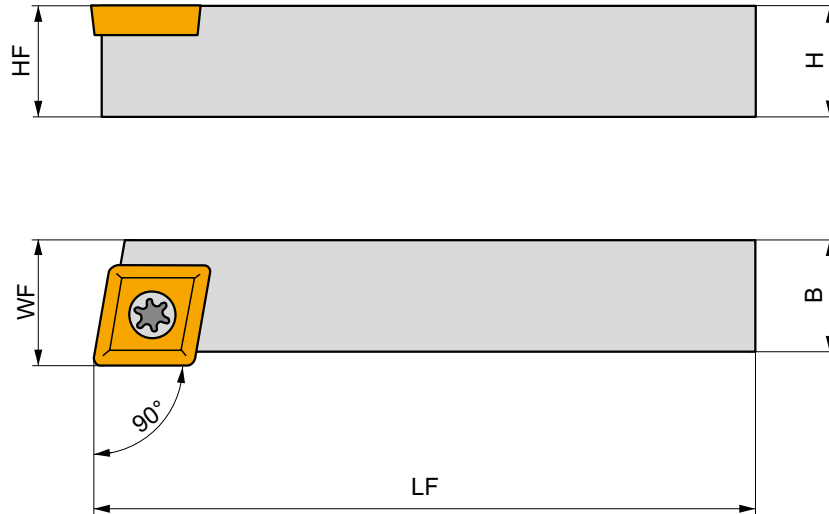
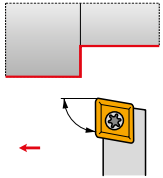

Codice prodotto	H	B	HF	WF	LF	LAMS	GAMO	kg	G1045	S07
	(mm)	(mm)	(mm)	(mm)	(mm)	(°)	(°)			
R SCACR 0808 D 06	8	8	8	8.5	60	0	0	0.04	G1045	S07
SCACR 1010 E 06	10	10	10	10.5	70	0	0	0.09	G1045	S07
SCACR 1212 F 09	12	12	12	12.5	80	0	0	0.12	G1041	S04
SCACR 1616 H 09	16	16	16	16.5	100	0	0	0.22	G1041	S04
L SCACL 0808 D 06	8	8	8	8.5	60	0	0	0.07	G1045	S07
SCACL 1010 E 06	10	10	10	10.5	70	0	0	0.06	G1045	S07
SCACL 1212 F 09	12	12	12	12.5	80	0	0	0.12	G1041	S04
SCACL 1616 H 09	16	16	16	16.5	100	0	0	0.22	G1041	S04



G1041
G1045

CC.. 09T3..
CC.. 0602..



S04
S07

US 3510-T15P
US 2506-T07P

3.0
0.9

M 3.5
M 2.5

10.6
6.3

FLAG T15P
FLAG T07P



SCBC(RL) EXT



Utensile esterno, bloccaggio a vite, inserti CC... angolo del tagliente utensile 75°

Utensile di tornitura esterna destro/sinistro con bloccaggio a vite, angolo del tagliente utensile 75° per inserti positivi CC...09 o 12. Adatto per operazioni di tornitura longitudinale e smussi. Disponibile con stelo da 12x12 a 25x25 mm. Corpo trattato per una maggiore durata.

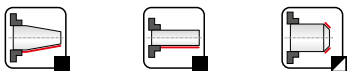
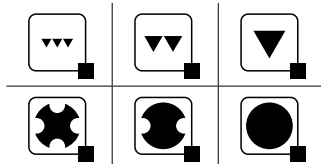
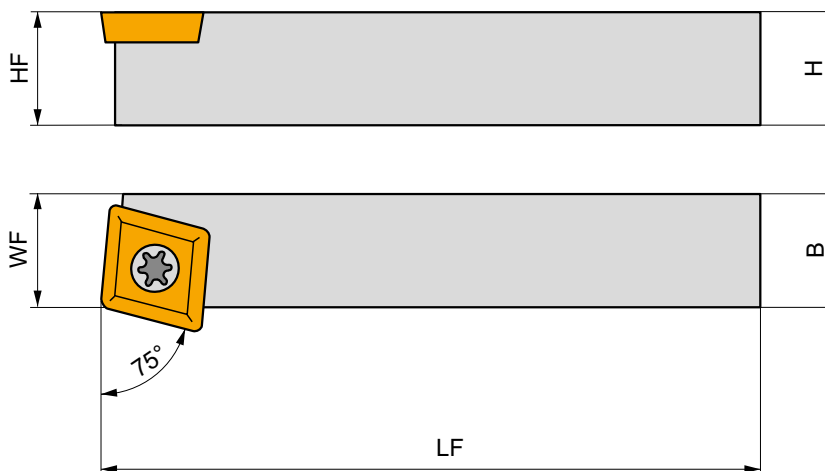
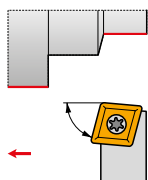

Codice prodotto	H	B	HF	WF	LF	LAMS	GAMO	kg		
	(mm)	(mm)	(mm)	(mm)	(mm)	(°)	(°)			
R SCBCR 1212 F 09	12	12	12	11	80	0	0	0.10	GI041	S08
SCBCR 1616 H 09	16	16	16	13	100	0	0	0.20	GI041	S08
SCBCR 2020 K 12-M-A	20	20	20	17	125	0	0	0.45	GI011	SC20
SCBCR 2525 M 12-M-A	25	25	25	22	150	0	0	0.61	GI011	SC20
L SCBCL 1212 F 09	12	12	12	11	80	0	0	0.10	GI041	S08
SCBCL 1616 H 09	16	16	16	13	100	0	0	0.22	GI041	S08
SCBCL 2020 K 12-M-A	20	20	20	17	125	0	0	0.43	GI011	SC20
SCBCL 2525 M 12-M-A	25	25	25	22	150	0	0	0.75	GI011	SC20



GI011
GI041



CC.. 1204..
CC.. 09T3..



SC20
S08



US 5012-T15P
US 3510-T15P



5.0
3.0



M 5
M 3.5



12.2
10.6



SCN 120304
-



MS 5008
-



FLAG T15P
FLAG T15P



HXK 5
-



SCDCR EXT



PRAMET

S



Utensile esterno, bloccaggio a vite, angolo del tagliente utensile 45°, inserti CC..

Utensile esterno di tornitura destro con angolo del tagliente utensile a 45° per inserti CC .. 06 con bloccaggio a vite. Adatto per tornitura longitudinale esterna senza spallamento, conica, copiatura multidirezionale e smussi. Disponibile con stelo 10x10 mm. Corpo trattato per una maggiore durata dell'utensile.

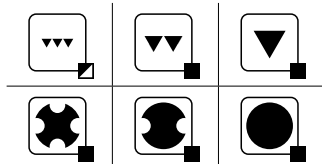
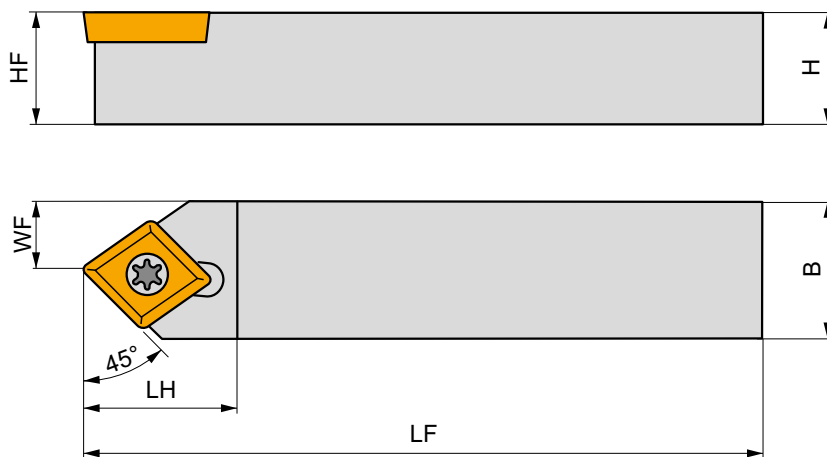
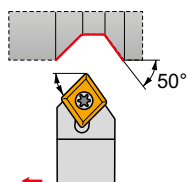

Codice prodotto	H	B	HF	WF	LF	LH	LAMS	GAMO	kg		
	(mm)	(mm)	(mm)	(mm)	(mm)	(mm)	(°)	(°)			
R SCDCR 1010 E 06	10	10	10	5.11	70	11	0	0	0.06	GI045	SC21

GI045	CC..0602..

SC21	5513 020-03	0.8	M 2.5	6.5	PT-8001



SCFC(RL) EXT



Utensile esterno, bloccaggio a vite, inserti CC... angolo del tagliente utensile 90°

Utensile di tornitura esterna destro/sinistro con bloccaggio a vite, angolo del tagliente utensile 90° per inserti positivi CC...06 o 09. Adatto per operazioni di sfacciatura e tornitura longitudinale con spallamento, conicità e smussi. Disponibile con stelo da 08x08 a 16x16 mm. Corpo trattato per una maggiore durata.

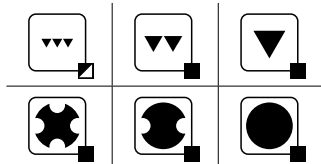
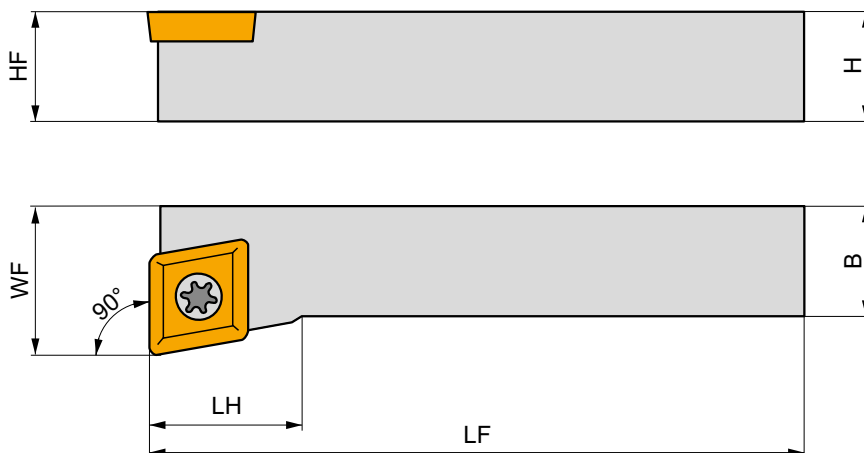
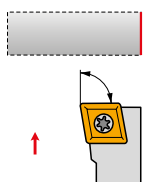

Codice prodotto	H	B	HF	WF	LF	LH	LAMS	GAMO	kg			
	(mm)	(mm)	(mm)	(mm)	(mm)	(mm)	(°)	(°)				
R	SCFCR 0808 D 06	8	8	8	10	60	8	0	0	0.04	GI045	S07
	SCFCR 1010 E 06	10	10	10	12	70	8	0	0	0.07	GI045	S07
	SCFCR 1212 F 09	12	12	12	16	80	16	0	0	0.12	GI041	S04
	SCFCR 1616 H 09	16	16	16	20	100	16	0	0	0.22	GI041	S04
L	SCFCL 0808 D 06	8	8	8	10	60	8	0	0	0.04	GI045	S07
	SCFCL 1010 E 06	10	10	10	12	70	8	0	0	0.06	GI045	S07
	SCFCL 1212 F 09	12	12	12	16	80	16	0	0	0.10	GI041	S04
	SCFCL 1616 H 09	16	16	16	20	100	16	0	0	0.22	GI041	S04



GI041
GI045

CC.. 09T3..
CC.. 0602..



S04
S07

US 3510-T15P
US 2506-T07P

3.0
0.9

M 3.5
M 2.5

10.6
6.3

FLAG T15P
FLAG T07P

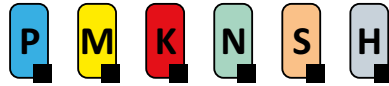
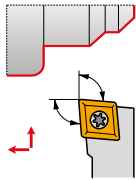

SCLC(RL) EXT

Utensile esterno, bloccaggio a vite, inserti CC... angolo del tagliente utensile 95°

Utensile di tornitura esterna destro/sinistro con bloccaggio a vite, angolo del tagliente utensile 95° per inserti positivi CC...06, 08, 09 o 12. Adatto per operazioni di tornitura longitudinale con spallamento, conicità e smussi. Disponibile con stelo da 08x08 a 25x25 mm. Corpo trattato per una maggiore durata.

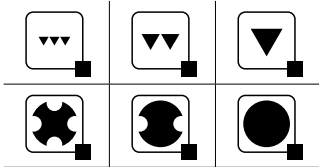
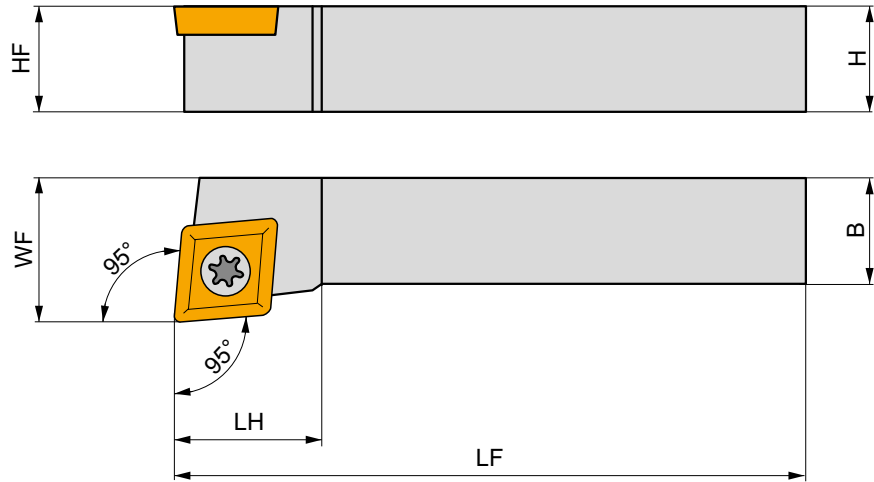

Codice prodotto	H	B	HF	WF	LF	LH	LAMS	GAMO	kg		
	(mm)	(mm)	(mm)	(mm)	(mm)	(mm)	(°)	(°)			
R SCLCR 0808 D 06	8	8	8	10	60	8	0	0	0.06	GI045	S01
SCLCR 1010 E 06	10	10	10	12	70	8	0	0	0.09	GI045	S01
SCLCR 1010 E 08	10	10	10	12	70	13.2	0	0	0.03	GI232	SC22
SCLCR 1212 F 08	12	12	12	16	80	13.4	0	0	0.02	GI232	SC22
SCLCR 1616 H 08	16	16	16	20	100	15.2	0	0	0.22	GI232	SC22
SCLCR 1212 F 09	12	12	12	16	80	16	0	0	0.12	GI041	S08
SCLCR 1616 H 09	16	16	16	20	100	16	0	0	0.22	GI041	S08
SCLCR 2020 K 12-M-A	20	20	20	25	125	20	0	0	0.44	GI011	SC20
SCLCR 2525 M 12-M-A	20	25	20	32	150	20	0	0	0.68	GI011	SC20
L SCLCL 0808 D 06	8	8	8	10	60	8	0	0	0.06	GI045	S01
SCLCL 1010 E 06	10	10	10	12	70	8	0	0	0.06	GI045	S01
SCLCL 1212 F 08	12	12	12	16	80	13.4	0	0	0.03	GI232	SC22
SCLCL 1616 H 08	16	16	16	20	100	15.2	0	0	0.23	GI232	SC22
SCLCL 1212 F 09	12	12	12	16	80	16	0	0	0.10	GI041	S08
SCLCL 1616 H 09	16	16	16	20	100	16	0	0	0.22	GI041	S08
SCLCL 2020 K 12-M-A	20	20	20	25	125	20	0	0	0.40	GI011	SC20
SCLCL 2525 M 12-M-A	25	25	25	32	150	20	0	0	0.78	GI011	SC20



GI011
GI041
GI045
GI232

CC.. 1204..
CC.. 09T3..
CC.. 0602..
CC.. 0803..



SC20
SC22
S01
S08

US 5012-T15P
5513 020-04
US 2506-T07P
US 3510-T15P

5.0
1.5
0.9
3.0

M 5
M 3
M 2.5
M 3.5

12.2
7.2
6.3
10.6

SCN 120304
-
-
-

MS 5008
-
-
-

FLAG T15P
PT-8003
FLAG T07P
FLAG T15P

HXK 5
-
-
-

NEW
C.-SCLC(RL) EXT

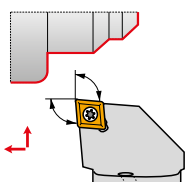
S

Utensile PSC esterno a cambio rapido, bloccaggio a vite per inserto CC... angolo del tagliente ut. 95°

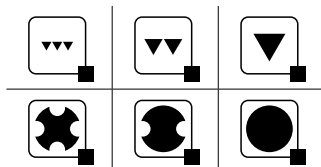
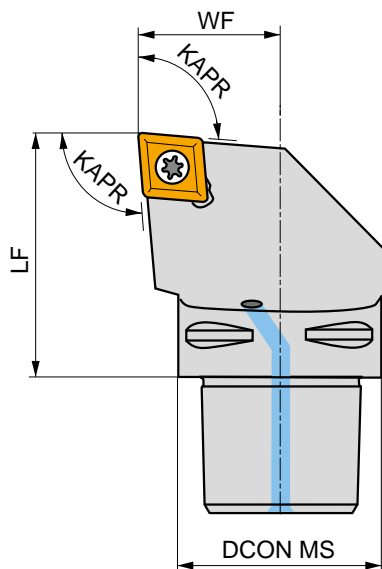
Utensile destro/sinistro per tornitura esterna con bloccaggio a vite e passaggio refrigerante interno, angolo del tagliente utensile 95° per inserti positivi CC... 09 e CC...12. Adatto per la tornitura esterna longitudinale, spallamenti, conicità e smussi. Attacco PSC (Attacco Poligonale) da C3 a C5. Corpo trattato per una maggiore durata.



	Codice prodotto	DCON MS	WF	LF	KAPR	LAMS	GAMMO				
		(mm)	(mm)	(mm)	(°)	(°)	(°)				
R	C3-SCLCR-22040-09	32	22	40	95	0	0	✓	0.21	GI041	C-SC09S
	C4-SCLCR-27050-09	40	27	50	95	0	0	✓	0.39	GI041	C-SC09S
	C4-SCLCR-27050-12	40	27	50	95	0	0	✓	0.40	GI011	C-SC12-1
	C5-SCLCR-35060-12	50	35	60	95	0	0	✓	0.72	GI011	C-SC12-2
L	C3-SCLCL-22040-09	32	22	40	95	0	0	✓	0.21	GI041	C-SC09S
	C4-SCLCL-27050-09	40	27	50	95	0	0	✓	0.39	GI041	C-SC09S
	C5-SCLCL-35060-12	50	35	60	95	0	0	✓	0.72	GI011	C-SC12-2



GI011

CC.. 1204..

GI041

CC.. 09T3..



C-SC09S	US 2001-T15P	3.0	M 3.5	12.1	SCS 232-01	MS 9001	FLAG T15P/3,5	CN 034-01
C-SC12-1	US 2018-T15P	3.0	M 4	14	SCS 232-02	MS 9003	FLAG T15P/4	CN 034-01
C-SC12-2	US 2018-T15P	3.0	M 4	14	SCS 232-02	MS 9003	FLAG T15P/4	CN 034-02



SCFC(RL) INT



PRAMET

S



Utensile interno, bloccaggio a vite, inserti CC... angolo del tagliente utensile 90°

Bareno destro/sinistro per tornitura interna con bloccaggio a vite, angolo del tagliente utensile 90° per inserto positivo CC...06. Diametro interno minimo tornibile Ø13 mm. Adatto per operazioni di sfacciatura interna e tornitura longitudinale con spallamento, conicità e smussi. Disponibile con stelo da Ø10 mm a Ø12 mm. Corpo trattato per una maggiore durata.

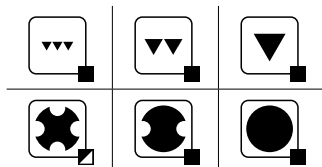
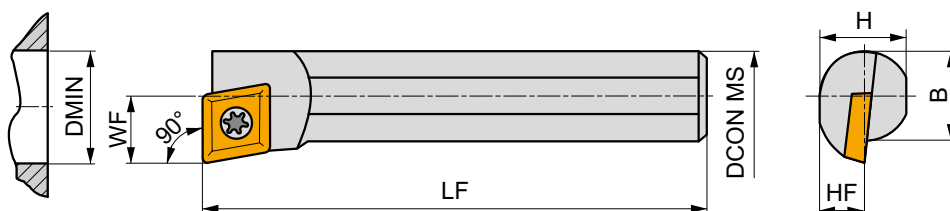
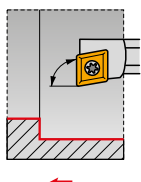

Codice prodotto	DCON MS (mm)	DMIN (mm)	WF (mm)	H (mm)	B (mm)	LF (mm)	LAMS (°)	GAMO (°)	kg	GI045	S06
R S10H-SCFCR 06	10	13	7	9	9.5	100	-10	0	0.08	GI045	S06
S12K-SCFCR 06	12	16	9	11	11.5	125	-7	0	0.11	GI045	S06
L S10H-SCFCL 06	10	13	7	9	9.5	100	-10	0	0.10	GI045	S06
S12K-SCFCL 06	12	16	9	11	11.5	125	-7	0	0.14	GI045	S06



GI045



CC..0602..



S06



US 2505-T07P



0.9



M 2.5



5.2



FLAG T07P



SCKC(RL) INT



Utensile interno, bloccaggio a vite, inserti CC... angolo del tagliente utensile 75°

Bareno destro/sinistro per tornitura interna con bloccaggio a vite, angolo del tagliente utensile 75° per inserti positivi CC...06, 09 o 12. Diametro interno minimo tornibile Ø11 mm. Adatto per operazioni di tornitura longitudinale interna con spallamento, conicità e smussi. Disponibile con stelo da Ø8 mm a Ø32 mm. Corpo trattato per una maggiore durata.

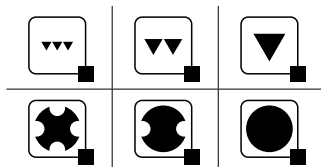
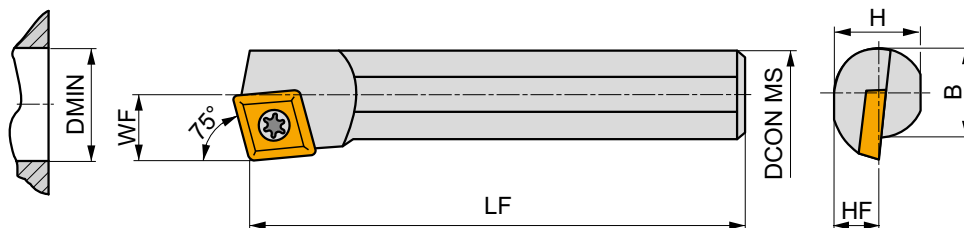
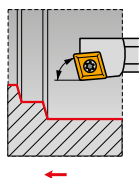

Codice prodotto	DCON MS	DMIN	WF	H	B	LF	LAMS	GAMO	kg	G1045	S02	
	(mm)	(mm)	(mm)	(mm)	(mm)	(mm)	(°)	(°)				
R	S08F-SCKCR 06	8	11	6	7.2	7.6	80	-12	0	0.03	G1045	S02
	S12K-SCKCR 06	12	16	9	11	11.5	125	-8	0	0.11	G1045	S02
	S16M-SCKCR 09-A	16	20	11	14.5	15	150	-8	0	0.25	G1041	S05
	S20S-SCKCR 09	20	25	13	18.5	18.5	250	-5	0	0.60	G1041	S08
	S25T-SCKCR 09	25	32	17	23	23	300	-3	0	1.15	G1041	S08
	S32U-SCKCR 12-A	32	40	22	30	30	350	-10	0	2.10	G1011	SC20
L	S08F-SCKCL 06	8	11	6	7.2	7.6	80	-12	0	0.03	G1045	S02
	S12K-SCKCL 06	12	16	9	11	11.5	125	-8	0	0.11	G1045	S02
	S16M-SCKCL 09-A	16	20	11	14.5	15	150	-8	0	0.24	G1041	S05
	S20S-SCKCL 09	20	25	13	18.5	18.5	250	-5	0	0.60	G1041	S08
	S25T-SCKCL 09	25	32	17	23	23	300	-3	0	1.15	G1041	S08
	S32U-SCKCL 12-A	32	40	22	30	30	350	-10	0	2.10	G1011	SC20



G1011

CC.. 1204..

G1041

CC.. 09T3..

G1045

CC.. 0602..



SC20

US 5012-T15P

5.0

M 5

12.2

SCN 120304

MS 5008

FLAGT15P

HXK 5

S02

US 2505-T07P

0.9

M 2.5

5.2

-

-

FLAGT07P

-

S05

US 4008-T15P

3.5

M 4

8

-

-

FLAGT15P

-

S08

US 3510-T15P

3.0

M 3.5

10.6

-

-

FLAGT15P

-



SCLC(RL) INT

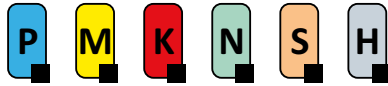

Utensile interno, bloccaggio a vite, inserti CC... angolo del tagliente utensile 95°

Bareno destro/sinistro per tornitura interna con bloccaggio a vite e passaggio refrigerante interno, angolo del tagliente utensile 95° per inserti positivi CC...06, 08, 09 o 12. Diametro interno minimo tornibile Ø11 mm. Adatto per operazioni di tornitura longitudinale, spallamento, conicità e smussi. Disponibile con stelo da Ø8 mm a Ø32 mm. Corpo trattato per una maggiore durata.

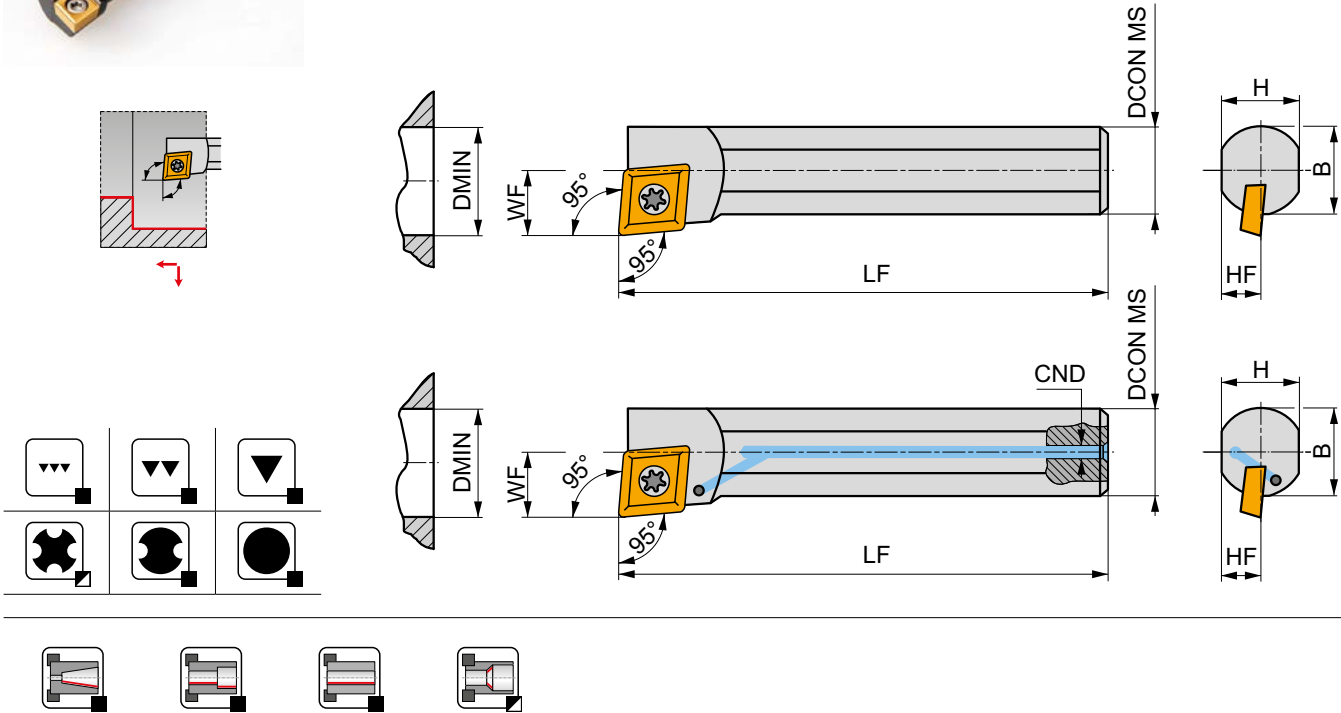

Codice prodotto	DCON MS	DMIN	WF	H	B	LF	CND	LAMS	GAMO				
	(mm)	(mm)	(mm)	(mm)	(mm)	(mm)	(°)	(°)					
A08H-SCLCR 06	8	11	6	7.2	7.6	100	3.5	-13	0	✓	0.06	GI045	S02
S08F-SCLCR 06	8	11	6	7.2	7.6	80	-	-13	0	-	0.06	GI045	S02
A10H-SCLCR 06	10	13	7	9	-	100	4	-10	0	✓	0.07	GI045	S02
S10H-SCLCR 06	10	13	7	9	9.5	100	-	-10	0	-	0.08	GI045	S02
A12K-SCLCR 06	12	16	9	11	-	125	5	-8	0	✓	0.11	GI045	S01
S12K-SCLCR 06	12	16	9	11	11.5	125	-	-8	0	-	0.13	GI045	S01
S16M-SCLCR 06	16	20	11	14.5	15	150	-	-8	0	-	0.25	GI045	S01
A10K-SCLCR 08	10	12	6	9	9.5	125	4	-14	0	✓	0.09	GI232	SC22
A12M-SCLCR 08	12	16	9	11	11.5	150	5	-5	0	✓	0.14	GI232	SC22
A16R-SCLCR 08	16	20	11	14	15	200	6	-8	0	✓	0.28	GI232	SC22
A16M-SCLCR 09-A	16	20	11	14.5	-	150	6	-8	0	✓	0.22	GI041	S05
S16M-SCLCR 09-A	16	20	11	14.5	15	150	-	-8	0	-	0.25	GI041	S05
A20Q-SCLCR 09	20	25	13	18	-	180	8	-5	0	✓	0.38	GI041	S08
S20S-SCLCR 09	20	25	13	18	18.5	250	-	-5	0	-	0.62	GI041	S08
A25R-SCLCR 09	25	32	17	23	23	200	8	-3	0	✓	0.60	GI041	S08
S25T-SCLCR 09	25	32	17	23	23	300	-	-3	0	-	1.10	GI041	S08
A32S-SCLCR 12-A	32	40	22	30	30	250	8	-10	0	✓	1.35	GI011	SC20
S32U-SCLCR 12-A	32	40	22	30	30	350	-	-10	0	-	2.10	GI011	SC20
A08H-SCLCL 06	8	11	6	7.2	7.6	100	-	-13	0	✓	0.06	GI045	S02
S08F-SCLCL 06	8	11	6	7.2	7.6	80	-	-13	0	-	0.05	GI045	S02
A10H-SCLCL 06	10	13	7	9	-	100	4	-10	0	✓	0.06	GI045	S02
S10H-SCLCL 06	10	13	7	9	9.5	100	-	-10	0	-	0.06	GI045	S02
A12K-SCLCL 06	12	16	9	11	-	125	5	-8	0	✓	0.10	GI045	S01
S12K-SCLCL 06	12	16	9	11	11.5	125	-	-8	0	-	0.11	GI045	S01
S16M-SCLCL 06	16	20	11	14.5	15	150	-	-8	0	-	0.26	GI045	S01
A10K-SCLCL 08	10	12	6	9	9.5	125	4	-14	0	✓	0.02	GI232	SC22
A12M-SCLCL 08	12	16	9	11	11.5	150	5	-5	0	✓	0.14	GI232	SC22



Codice prodotto	DCON MS	DMIN	WF	H	B	LF	CND	LAMS	GAMO				
	(mm)	(mm)	(mm)	(mm)	(mm)	(mm)	(mm)	(°)	(°)				
A16R-SCLCL 08	16	20	11	14	15	200	6	-8	0	✓	0.30	GI232	SC22
A16M-SCLCL 09-A	16	20	11	14.5	-	150	6	-8	0	✓	0.22	GI041	S05
S16M-SCLCL 09-A	16	20	11	14.5	15	150	-	-8	0	-	0.24	GI041	S05
A20Q-SCLCL 09	20	25	13	18	-	180	8	-5	0	✓	0.40	GI041	S08
S20S-SCLCL 09	20	25	13	18	18.5	250	-	-5	0	-	0.60	GI041	S08
A25R-SCLCL 09	25	32	17	23	23	200	8	-3	0	✓	0.67	GI041	S08
S25T-SCLCL 09	25	32	17	23	23	300	-	-3	0	-	1.15	GI041	S08
A32S-SCLCL 12-A	32	40	22	30	30	250	8	-10	0	✓	1.35	GI011	SC20
S32U-SCLCL 12-A	32	40	22	30	30	350	-	-10	0	-	2.10	GI011	SC20



GI011	CC.. 1204..
GI041	CC.. 09T3..
GI045	CC.. 0602..
GI232	CC.. 0803..



SC20	US 5012-T15P	5.0	M 5	12.2	SCN 120304	MS 5008	FLAG T15P	HXK 5
SC22	5513 020-04	1.5	M 3	7.2	-	-	PT-8003	-
S01	US 2506-T07P	0.9	M 2.5	6.3	-	-	FLAG T07P	-
S02	US 2505-T07P	0.9	M 2.5	5.2	-	-	FLAG T07P	-
S05	US 4008-T15P	3.5	M 4	8	-	-	FLAG T15P	-
S08	US 3510-T15P	3.0	M 3.5	10.6	-	-	FLAG T15P	-



SCXC(RL) INT

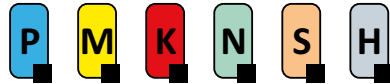

PRAMET



Utensile interno, bloccaggio a vite, inserti CC... angolo del tagliente utensile 40°

Bareno destro/sinistro per tornitura interna con bloccaggio a vite, angolo del tagliente utensile 40° per inserto positivo CC...06. Diametro interno minimo tornibile Ø13 mm. Adatto per operazioni di retro smussi e copiatura frontale interna, tornitura longitudinale, conicità e smussi. Disponibile con stelo da Ø10 mm a Ø16 mm. Corpo trattato per una maggiore durata.

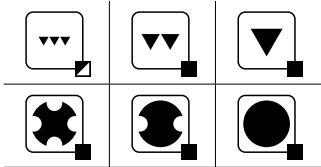
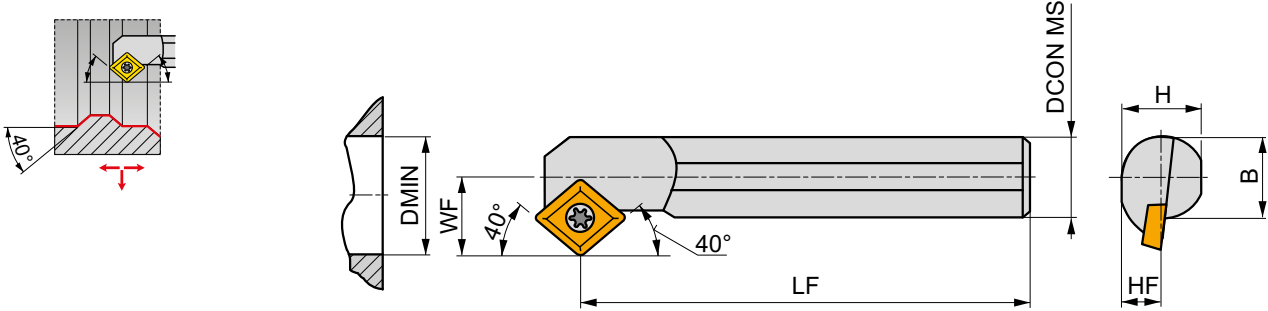

Codice prodotto	DCON MS (mm)	DMIN (mm)	WF (mm)	H (mm)	B (mm)	LF (mm)	LAMS (°)	GAMO (°)	kg	GI045	S06/S07
R S10H-SCXCR 06	10	13	7	9	9.5	100	-10	0	0.06	GI045	S06
S12K-SCXCR 06	12	16	9	11	11.5	125	-8	0	0.11	GI045	S06
S16Q-SCXCR 06	16	20	11	14.5	15	180	-7	0	0.31	GI045	S07
L S10H-SCXCL 06	10	13	7	9	9.5	100	-10	0	0.06	GI045	S06
S12K-SCXCL 06	12	16	9	11	11.5	125	-8	0	0.11	GI045	S06
S16Q-SCXCL 06	16	20	11	14.5	15	180	-7	0	0.30	GI045	S07

GI045	CC.. 0602..
-------	-------------

S06/S07	US 2505-T07P / US 2506-T07P	Nm	M 2.5	5.2 / 6.3	FLAGT07P
S06	US 2505-T07P	0.9	M 2.5	5.2	FLAGT07P
S07	US 2506-T07P	0.9	M 2.5	6.3	FLAGT07P

NEW
C.-SCLC(RL) INT

PRAMET
S

Utensile PSC interno a cambio rapido, bloccaggio a vite per inserto CC... angolo del tagliente ut. 95°

Utensile destro/sinistro per tornitura interna con bloccaggio a vite e passaggio refrigerante interno, angolo del tagliente utensile 95° per inserto positivo CC... 09. Diametro interno minimo tornibile Ø20 mm. Adatto per un'ampia gamma di applicazioni di tornitura interna. Attacco PSC (Attacco Poligonale) da C3 a C5 con lunghezze diverse. Corpo trattato per una maggiore durata.

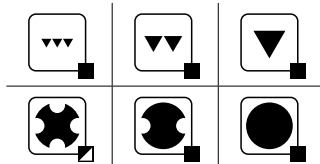
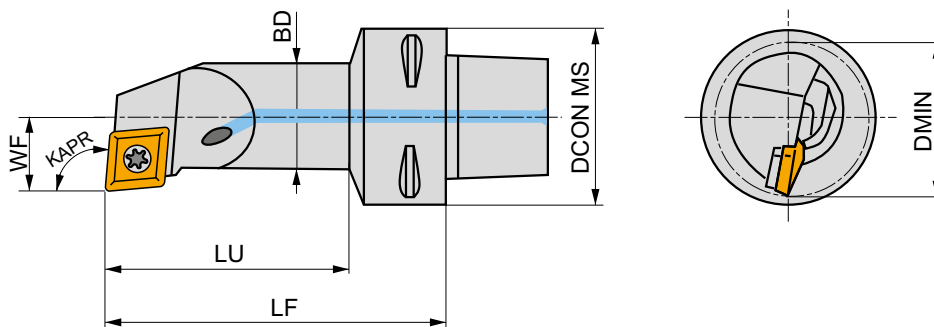
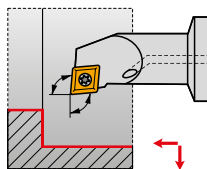

Codice prodotto	DCON MS	DMIN	WF	LF	LU	BD	KAPR	LAMS	GAMO	✓	kg	GI041	SC09M
	(mm)	(mm)	(mm)	(mm)	(mm)	(mm)	(°)	(°)	(°)				
R C3-SCLCR-11065-09	32	20	11	65	48	16	95	-8.4	0	✓	0.21	GI041	SC09M
C3-SCLCR-13075-09	32	25	13	75	58	20	95	-5.8	0	✓	0.26	GI041	SC09M
C4-SCLCR-11070-09	40	20	11	70	47	16	95	-8.4	0	✓	0.36	GI041	SC09M
C4-SCLCR-13080-09	40	25	13	80	57	20	95	-5.8	0	✓	0.41	GI041	SC09M
C4-SCLCR-17090-09	40	32	17	90	68	25	95	-3.4	0	✓	0.50	GI041	SC09M
C5-SCLCR-11070-09	50	20	11	70	46	16	95	-8.4	0	✓	0.55	GI041	SC09M
C5-SCLCR-13080-09	50	25	13	80	56	20	95	-5.8	0	✓	0.60	GI041	SC09M
L C4-SCLCL-11070-09	40	20	11	70	47	16	95	-8.4	0	✓	0.36	GI041	SC09M
C4-SCLCL-13080-09	40	25	13	80	57	20	95	-5.8	0	✓	0.62	GI041	SC09M
C5-SCLCL-11070-09	50	20	11	70	46	16	95	-8.4	0	✓	0.55	GI041	SC09M
C5-SCLCL-13080-09	50	25	13	80	56	20	95	-5.8	0	✓	0.60	GI041	SC09M



GI041



CC..09T3..



SC09M



US 2009-T15P



3.0



M 3.5



8.1



FLAGT15P/3,5



CP

05

INSERTI IN METALLO DURO

CPGX

 83







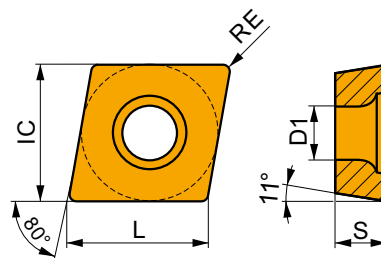



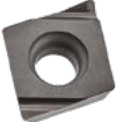
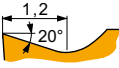



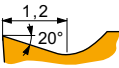

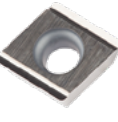
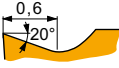

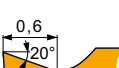

CPGX

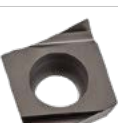
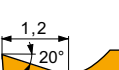
	IC (mm)	D1 (mm)	L (mm)	S (mm)
0602	6.350	2.80	6.40	2.38
0803	7.940	3.40	8.10	3.18
09T3	9.525	4.40	9.70	3.97

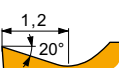

Idoneità e valori iniziali per velocità di taglio (Vc), avanzamento (f) e profondità di taglio (ap). Fare riferimento alla nostra App Machining Calculator per ulteriori calcoli.

Codice prodotto	RE (mm)	P			M			K			N			S			H					
		vc (m/min)	f (mm/rev)	ap (mm)	vc (m/min)	f (mm/rev)	ap (mm)	vc (m/min)	f (mm/rev)	ap (mm)	vc (m/min)	f (mm/rev)	ap (mm)	vc (m/min)	f (mm/rev)	ap (mm)	vc (m/min)	f (mm/rev)	ap (mm)			
				FR-IQ geometria destra positiva, adatta per operazioni di super finitura, taglio continuo.																		
CPGX 080304FR-IQ	TT010 0.4	350	0.06	0.5	210	0.05	0.5	-	-	-	-	-	-	-	-	-	-	-	-			
				FL-IQ geometria positiva sinistra per operazioni di super finitura, taglio continuo.																		
CPGX 080304FL-IQ	TT010 0.4	350	0.06	0.5	210	0.05	0.5	-	-	-	-	-	-	-	-	-	-	-	-			
CPGX 09T304FL-IQ	TT010 0.4	350	0.06	0.5	210	0.05	0.5	-	-	-	-	-	-	-	-	-	-	-	-			
				FR-JR geometria destra positiva, adatta per operazioni di super finitura, taglio continuo.																		
CPGX 060204FR-JR	TT010 0.4	350	0.06	0.5	210	0.05	0.5	-	-	-	-	-	-	-	-	-	-	-	-			
CPGX 080304FR-JR	TT010 0.4	350	0.06	0.5	210	0.05	0.5	-	-	-	-	-	-	-	-	-	-	-	-			
				FL-JR geometria positiva sinistra per operazioni di super finitura, taglio continuo.																		
CPGX 060204FL-JR	TT010 0.4	350	0.06	0.5	210	0.05	0.5	-	-	-	-	-	-	-	-	-	-	-	-			
CPGX 080304FL-JR	TT010 0.4	350	0.06	0.5	210	0.05	0.5	-	-	-	-	-	-	-	-	-	-	-	-			
				FR-JZ geometria destra positiva, adatta per operazioni di super finitura, taglio continuo.																		
CPGX 060202FR-JZ	TT010 0.2	330	0.06	0.5	195	0.05	0.5	-	-	-	-	-	-	-	-	-	-	-	-			
				FL-JZ geometria positiva sinistra per operazioni di super finitura, taglio continuo.																		
CPGX 060202FL-JZ	TT010 0.2	330	0.06	0.5	195	0.05	0.5	-	-	-	-	-	-	-	-	-	-	-	-			



DC

07 / 11 / 15

INSERTI IN METALLO DURO

DCGT	DCMT	DCMW
86	87	92

INSERTI CBN & PCD

DCGW CBN	DCMW PCD
92	93

ABBINAMENTO DELLA DIMENSIONE CORRETTA (esempio)

Inserto	Portainsero
DCMT 070204E-UR	SDJCR 0808 D 07

TORNITURA ISO - ESTERNA

SDJC(RL) EXT		SDNCN EXT		C.-SDNCN EXT NEW		C.-SDJC(RL) EXT NEW	
93°	DC..	62°30'	DC..	62°30'	DC..	93°	DC..
07 11 15		7 11		11		11	
08×08 25×25		08×08 25×25		C4 C5		C3 C5	
94	86-93	95	86-93	97	86-93	96	86-93



DC

07 / 11 / 15

TORNITURA ISO INTERNA

SDQC(RL) INT

107°30'

DC..

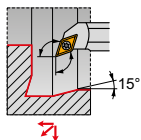
07
11 $\frac{13}{40}$

98

86-93

SDUC(RL) INT

93°

DC..

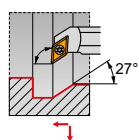
07
11 $\frac{13}{40}$

99

86-93

SDUC(RL)-E INT

93°

DC..

07
11 $\frac{13}{40}$

100

86-93

SDZC(RL) INT

93°

DC..

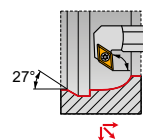
07
11 $\frac{27}{65}$

101

86-93

C.-SDUC(RL) INT **NEW**

93°

DC..

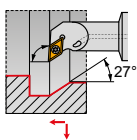
07
11 $\frac{20}{32}$

102

86-93



DCGT



	IC	D1	L	S
	(mm)	(mm)	(mm)	(mm)
0702	6.350	2.80	7.80	2.38
0702-SF3	6.350	2.80	7.80	2.58
11T3	9.525	4.40	11.60	3.97
11T3-SF3	9.525	4.40	11.60	4.22

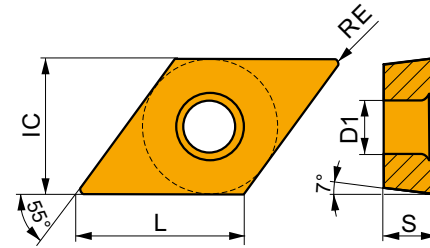

Idoneità e valori iniziali per velocità di taglio (Vc), avanzamento (f) e profondità di taglio (ap). Fare riferimento alla nostra App Machining Calculator per ulteriori calcoli.

Codice prodotto	RE	P			M			K			N			S			H		
		vc	f	ap	vc	f	ap	vc	f	ap	vc	f	ap	vc	f	ap	vc	f	ap
	(mm)	(m/min)	(mm/rev)	(mm)	(m/min)	(mm/rev)	(mm)	(m/min)	(mm/rev)	(mm)	(m/min)	(mm/rev)	(mm)	(m/min)	(mm/rev)	(mm)	(m/min)	(mm/rev)	(mm)



AL geometria con design altamente positivo per operazioni da finitura fino a sgrossatura, da taglio continuo a leggermente interrotto.

DCGT 070202F-AL	HF7	0.2	-	-	-	-	-	-	-	360	0.12	1.0	-	-	-	-	-	-
	T0315	0.2	-	-	-	-	-	-	-	510	0.12	1.0	-	-	-	-	-	-
DCGT 070204F-AL	HF7	0.4	-	-	-	-	-	-	-	285	0.24	1.0	-	-	-	-	-	-
	T0315	0.4	-	-	-	-	-	-	-	420	0.24	1.0	-	-	-	-	-	-
DCGT 11T302F-AL	HF7	0.2	-	-	-	-	-	-	-	345	0.12	1.5	-	-	-	-	-	-
	T0315	0.2	-	-	-	-	-	-	-	495	0.12	1.5	-	-	-	-	-	-
DCGT 11T304F-AL	HF7	0.4	-	-	-	-	-	-	-	270	0.24	1.5	-	-	-	-	-	-
	T0315	0.4	-	-	-	-	-	-	-	390	0.24	1.5	-	-	-	-	-	-
DCGT 11T308F-AL	HF7	0.8	-	-	-	-	-	-	-	255	0.48	1.5	-	-	-	-	-	-
	T0315	0.8	-	-	-	-	-	-	-	360	0.48	1.5	-	-	-	-	-	-

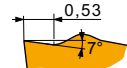

FF2 geometria positiva per operazioni da super finitura fino a finitura, da taglio continuo a leggermente interrotto.

DCGT 11T302E-FF2	T7325	0.2	190	0.05	0.8	-	-	-	-	-	-	-	-	-	-	-	-	-
	T8330	0.2	165	0.05	0.8	-	-	-	155	0.05	0.8	-	-	-	-	-	-	-
	T8430	0.2	225	0.05	0.8	-	-	-	185	0.05	0.8	-	-	-	-	-	-	-
	T9325	0.2	280	0.05	0.8	-	-	-	265	0.05	0.8	-	-	-	-	-	-	-
	TT010	0.2	275	0.05	0.5	-	-	-	-	-	-	-	-	-	-	-	-	-

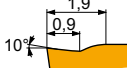

NF1 geometria con design positivo per operazioni da finitura fino a medie lavorazioni, taglio continuo.

DCGT 11T304E-NF1	T6310	0.4	145	0.10	0.8	100	0.09	0.8	-	-	-	435	0.12	0.8	40	0.07	0.6	25	0.15	1.0
	T7325	0.4	165	0.10	0.8	125	0.09	0.8	-	-	-	-	-	-	50	0.07	0.6	-	-	-
DCGT 11T308E-NF1	T6310	0.8	155	0.14	0.8	110	0.13	0.8	-	-	-	465	0.17	0.8	45	0.13	0.6	30	0.15	1.0
	T7325	0.8	180	0.14	0.8	140	0.13	0.8	-	-	-	-	-	-	55	0.13	0.6	-	-	-

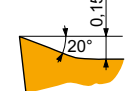

SF3 geometria con design altamente positivo per lavorazioni leggere e finitura, taglio continuo.

DCGT 070201E-SF3	T6310	0.1	160	0.05	0.5	115	0.05	0.5	125	0.05	0.5	480	0.06	0.5	45	0.04	0.4	30	0.15	1.0
DCGT 070202E-SF3	H07	0.2	-	-	-	95	0.05	0.8	150	0.05	0.8	485	0.06	0.8	45	0.04	0.6	-	-	-
	T6310	0.2	165	0.05	0.8	115	0.05	0.8	130	0.05	0.8	495	0.06	0.8	45	0.04	0.6	30	0.15	1.0
	T8315	0.2	175	0.05	0.8	105	0.05	0.8	165	0.05	0.8	525	0.06	0.8	40	0.04	0.6	35	0.15	1.0
DCGT 070204E-SF3	H07	0.4	-	-	-	75	0.09	0.8	120	0.10	0.8	390	0.12	0.8	35	0.07	0.6	-	-	-
	T6310	0.4	145	0.10	0.8	100	0.09	0.8	115	0.10	0.8	435	0.12	0.8	40	0.07	0.6	25	0.15	1.0
	T8315	0.4	155	0.10	0.8	90	0.09	0.8	145	0.10	0.8	465	0.12	0.8	35	0.07	0.6	30	0.15	1.0
DCGT 11T301E-SF3	T6310	0.1	160	0.05	0.5	115	0.05	0.5	125	0.05	0.5	480	0.06	0.5	45	0.04	0.4	30	0.15	1.0



Idoneità e valori iniziali per velocità di taglio (Vc), avanzamento (f) e profondità di taglio (ap). Fare riferimento alla nostra App Machining Calculator per ulteriori calcoli.

Codice prodotto	RE (mm)	P			M			K			N			S			H		
		vc (m/min)	f (mm/rev)	ap (mm)	vc (m/min)	f (mm/rev)	ap (mm)	vc (m/min)	f (mm/rev)	ap (mm)	vc (m/min)	f (mm/rev)	ap (mm)	vc (m/min)	f (mm/rev)	ap (mm)	vc (m/min)	f (mm/rev)	ap (mm)

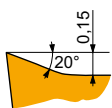

SF3 geometria con design altamente positivo per lavorazioni leggere e finitura, taglio continuo.

DCGT 11T302E-SF3	H07	0.2	-	-	-	95	0.05	0.8	150	0.05	0.8	485	0.06	0.8	45	0.04	0.6	-	-	-
	T6310	0.2	165	0.05	0.8	115	0.05	0.8	130	0.05	0.8	495	0.06	0.8	45	0.04	0.6	30	0.15	1.0
DCGT 11T304E-SF3	H07	0.4	-	-	-	75	0.09	0.8	120	0.10	0.8	390	0.12	0.8	35	0.07	0.6	-	-	-
	T6310	0.4	145	0.10	0.8	100	0.09	0.8	115	0.10	0.8	435	0.12	0.8	40	0.07	0.6	25	0.15	1.0
	T8315	0.4	155	0.10	0.8	90	0.09	0.8	145	0.10	0.8	465	0.12	0.8	35	0.07	0.6	30	0.15	1.0
DCGT 11T308E-SF3	H07	0.8	-	-	-	90	0.09	0.8	145	0.10	0.8	455	0.12	0.8	45	0.08	0.6	-	-	-
	T6310	0.8	170	0.10	0.8	120	0.09	0.8	135	0.10	0.8	510	0.12	0.8	50	0.08	0.6	30	0.15	1.0
	T8315	0.8	180	0.10	0.8	105	0.09	0.8	170	0.10	0.8	540	0.12	0.8	45	0.08	0.6	35	0.15	1.0

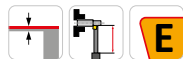

ER-SI geometria positiva destra per operazioni di finitura, taglio continuo.

DCGT 11T304ER-SI	T8330	0.4	170	0.12	0.8	100	0.11	0.8	160	0.12	0.8	-	-	-	40	0.10	0.6	-	-	-
	T8430	0.4	205	0.12	0.8	110	0.11	0.8	170	0.12	0.8	-	-	-	45	0.10	0.6	-	-	-
DCGT 11T308ER-SI	T8330	0.8	170	0.22	1.0	100	0.20	1.0	160	0.22	1.0	-	-	-	40	0.18	0.8	-	-	-
	T8430	0.8	190	0.22	1.0	105	0.20	1.0	155	0.22	1.0	-	-	-	40	0.18	0.8	-	-	-

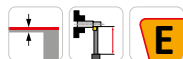

EL-SI geometria positiva sinistra per operazioni da finitura, taglio continuo.

DCGT 11T304EL-SI	T8330	0.4	170	0.12	0.8	100	0.11	0.8	160	0.12	0.8	-	-	-	40	0.10	0.6	-	-	-
	T8430	0.4	205	0.12	0.8	110	0.11	0.8	170	0.12	0.8	-	-	-	45	0.10	0.6	-	-	-
DCGT 11T308EL-SI	T8430	0.8	190	0.22	1.0	105	0.20	1.0	155	0.22	1.0	-	-	-	40	0.18	0.8	-	-	-

DCMT



	IC (mm)	D1 (mm)	L (mm)	S (mm)
0702	6.350	2.80	7.80	2.38
11T3	9.525	4.40	11.60	3.97
1504	12.700	5.50	15.50	4.76

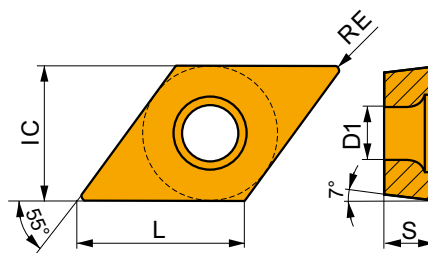

Idoneità e valori iniziali per velocità di taglio (Vc), avanzamento (f) e profondità di taglio (ap). Fare riferimento alla nostra App Machining Calculator per ulteriori calcoli.

Codice prodotto	RE (mm)	P			M			K			N			S			H		
		vc (m/min)	f (mm/rev)	ap (mm)	vc (m/min)	f (mm/rev)	ap (mm)	vc (m/min)	f (mm/rev)	ap (mm)	vc (m/min)	f (mm/rev)	ap (mm)	vc (m/min)	f (mm/rev)	ap (mm)	vc (m/min)	f (mm/rev)	ap (mm)

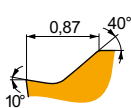

FF geometria positiva per operazioni da super finitura fino a finitura, da taglio continuo a leggermente interrotto.

DCMT 11T302E-FF	T8315	0.2	160	0.10	0.8	95	0.09	0.8	-	-	-	-	-	-	-	-	-	-	-	-
	T8330	0.2	150	0.10	0.8	90	0.09	0.8	-	-	-	-	-	-	-	-	-	-	-	-
	T8430	0.2	185	0.10	0.8	100	0.09	0.8	-	-	-	-	-	-	-	-	-	-	-	-
	T9315	0.2	255	0.10	0.8	-	-	-	-	-	-	-	-	-	-	-	-	-	-	-



Idoneità e valori iniziali per velocità di taglio (Vc), avanzamento (f) e profondità di taglio (ap). Fare riferimento alla nostra App Machining Calculator per ulteriori calcoli.

Codice prodotto	RE  (mm)	P			M			K			N			S			H		
		vc (m/min)	f (mm/rev)	ap (mm)	vc (m/min)	f (mm/rev)	ap (mm)	vc (m/min)	f (mm/rev)	ap (mm)	vc (m/min)	f (mm/rev)	ap (mm)	vc (m/min)	f (mm/rev)	ap (mm)	vc (m/min)	f (mm/rev)	ap (mm)

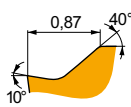

FF geometria positiva per operazioni da super finitura fino a finitura, da taglio continuo a leggermente interrotto.

DCMT 11T304E-FF	T8315	0.4	✓	160	0.12	0.8	✓	95	0.11	0.8	–	–	–	–	–	–	–	–	–
	T8330	0.4	■	150	0.12	0.8	✓	90	0.11	0.8	–	–	–	–	–	–	–	–	–
	T8430	0.4	■	185	0.12	0.8	✓	100	0.11	0.8	–	–	–	–	–	–	–	–	–
	T9315	0.4	■	255	0.12	0.8	–	–	–	–	–	–	–	–	–	–	–	–	–
DCMT 11T308E-FF	T8315	0.8	✓	180	0.15	0.8	✓	105	0.14	0.8	–	–	–	–	–	–	–	–	–
	T8330	0.8	■	170	0.15	0.8	✓	100	0.14	0.8	–	–	–	–	–	–	–	–	–
	T8430	0.8	■	200	0.15	0.8	✓	110	0.14	0.8	–	–	–	–	–	–	–	–	–
	T9315	0.8	■	270	0.15	0.8	–	–	–	–	–	–	–	–	–	–	–	–	–

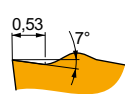

FF2 geometria positiva per operazioni da super finitura fino a finitura, da taglio continuo a leggermente interrotto.

DCMT 070202E-FF2	T7325	0.2	✓	190	0.05	0.8	–	–	–	–	–	–	–	–	–	–	–	–
	T8330	0.2	■	165	0.05	0.8	–	–	–	■	155	0.05	0.8	–	–	–	–	–
	T8430	0.2	■	225	0.05	0.8	–	–	–	✓	185	0.05	0.8	–	–	–	–	–
	T9325	0.2	■	280	0.05	0.8	–	–	–	✓	265	0.05	0.8	–	–	–	–	–
	TT010	0.2	■	275	0.05	0.5	–	–	–	–	–	–	–	–	–	–	–	–
DCMT 070204E-FF2	T7325	0.4	✓	160	0.12	0.8	–	–	–	–	–	–	–	–	–	–	–	–
	T8330	0.4	■	135	0.12	0.8	–	–	–	■	125	0.12	0.8	–	–	–	–	–
	T8430	0.4	■	170	0.12	0.8	–	–	–	✓	135	0.12	0.8	–	–	–	–	–
	T9315	0.4	■	230	0.12	0.8	–	–	–	✓	215	0.12	0.8	–	–	–	–	–
	T9325	0.4	■	205	0.12	0.8	–	–	–	✓	190	0.12	0.8	–	–	–	–	–
DCMT 070208E-FF2	T7325	0.8	✓	170	0.17	0.8	–	–	–	–	–	–	–	–	–	–	–	–
	T8330	0.8	■	150	0.17	0.8	–	–	–	■	140	0.17	0.8	–	–	–	–	–
	T8430	0.8	■	175	0.17	0.8	–	–	–	✓	140	0.17	0.8	–	–	–	–	–
	T9315	0.8	■	235	0.17	0.8	–	–	–	✓	220	0.17	0.8	–	–	–	–	–
	T9325	0.8	■	215	0.17	0.8	–	–	–	✓	200	0.17	0.8	–	–	–	–	–
DCMT 11T304E-FF2	T7325	0.4	✓	160	0.12	0.8	–	–	–	–	–	–	–	–	–	–	–	–
	T8330	0.4	■	135	0.12	0.8	–	–	–	■	125	0.12	0.8	–	–	–	–	–
	T8430	0.4	■	170	0.12	0.8	–	–	–	✓	135	0.12	0.8	–	–	–	–	–
	T9315	0.4	■	230	0.12	0.8	–	–	–	✓	215	0.12	0.8	–	–	–	–	–
	T9325	0.4	■	205	0.12	0.8	–	–	–	✓	190	0.12	0.8	–	–	–	–	–
	T9335	0.4	■	175	0.12	0.8	–	–	–	–	–	–	–	–	–	–	–	–
DCMT 11T308E-FF2	TT010	0.4	■	280	0.06	0.5	–	–	–	–	–	–	–	–	–	–	–	–
	T7325	0.8	✓	170	0.17	0.8	–	–	–	–	–	–	–	–	–	–	–	–
	T8330	0.8	■	150	0.17	0.8	–	–	–	■	140	0.17	0.8	–	–	–	–	–
	T8430	0.8	■	175	0.17	0.8	–	–	–	✓	140	0.17	0.8	–	–	–	–	–
	T9315	0.8	■	235	0.17	0.8	–	–	–	✓	220	0.17	0.8	–	–	–	–	–



FM geometria per operazioni da finitura fino a semi sgrossatura, da taglio continuo a leggermente interrotto.

DCMT 070202E-FM	T7325	0.2	✓	175	0.10	0.8	■	135	0.09	0.8	–	–	–	–	–	–	–	–	
	T8315	0.2	✓	160	0.10	0.8	■	95	0.09	0.8	✓	150	0.10	0.8	✓	480	0.12	0.8	–
	T8330	0.2	■	150	0.10	0.8	■	90	0.09	0.8	✓	140	0.10	0.8	✓	450	0.12	0.8	–
	T8430	0.2	■	185	0.10	0.8	■	100	0.09	0.8	✓	150	0.10	0.8	✓	510	0.12	0.8	–
	T9315	0.2	■	255	0.10	0.8	–	–	–	–	–	–	–	–	–	–	–	–	
	T9325	0.2	■	230	0.10	0.8	■	135	0.09	0.8	✓	215	0.10	0.8	–	–	–	–	



Idoneità e valori iniziali per velocità di taglio (Vc), avanzamento (f) e profondità di taglio (ap). Fare riferimento alla nostra App Machining Calculator per ulteriori calcoli.

Codice prodotto	RE  (mm)	P			M			K			N			S			H		
		vc (m/min)	f (mm/rev)	ap (mm)	vc (m/min)	f (mm/rev)	ap (mm)	vc (m/min)	f (mm/rev)	ap (mm)	vc (m/min)	f (mm/rev)	ap (mm)	vc (m/min)	f (mm/rev)	ap (mm)	vc (m/min)	f (mm/rev)	ap (mm)

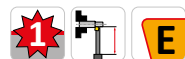
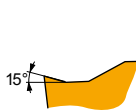

FM geometria per operazioni da finitura fino a semi sgrassatura, da taglio continuo a leggermente interrotto.

DCMT 070204E-FM	T7325	0.4	155	0.17	0.8	120	0.15	0.8	-	-	-	-	-	-	-	-	-	-
	T7335	0.4	155	0.17	0.8	120	0.15	0.8	-	-	-	-	-	-	-	-	-	-
	T8315	0.4	160	0.12	0.8	95	0.11	0.8	150	0.12	0.8	480	0.14	0.8	-	-	-	-
	T8330	0.4	150	0.12	0.8	90	0.11	0.8	140	0.12	0.8	450	0.14	0.8	-	-	-	-
	T8430	0.4	185	0.12	0.8	100	0.11	0.8	150	0.12	0.8	510	0.14	0.8	-	-	-	-
	T9315	0.4	255	0.12	0.8	-	-	-	240	0.12	0.8	-	-	-	-	-	-	-
T9325	0.4	190	0.18	0.8	110	0.16	0.8	180	0.18	0.8	-	-	-	-	-	-	-	
DCMT 11T302E-FM	T7325	0.2	175	0.10	0.8	135	0.09	0.8	-	-	-	-	-	-	-	-	-	
	T8315	0.2	160	0.10	0.8	95	0.09	0.8	150	0.10	0.8	480	0.12	0.8	-	-	-	
	T8330	0.2	150	0.10	0.8	90	0.09	0.8	140	0.10	0.8	450	0.12	0.8	-	-	-	
	T8430	0.2	185	0.10	0.8	100	0.09	0.8	150	0.10	0.8	510	0.12	0.8	-	-	-	
	T9315	0.2	255	0.10	0.8	-	-	-	240	0.10	0.8	-	-	-	-	-	-	
	T9325	0.2	230	0.10	0.8	135	0.09	0.8	215	0.10	0.8	-	-	-	-	-	-	
DCMT 11T304E-FM	T7325	0.4	155	0.17	0.8	120	0.15	0.8	-	-	-	-	-	-	-	-	-	
	T7335	0.4	155	0.17	0.8	120	0.15	0.8	-	-	-	-	-	-	-	-	-	
	T8315	0.4	160	0.12	0.8	95	0.11	0.8	150	0.12	0.8	480	0.14	0.8	-	-	-	
	T8330	0.4	135	0.17	0.8	80	0.15	0.8	125	0.17	0.8	405	0.20	0.8	-	-	-	
	T8430	0.4	155	0.17	0.8	85	0.15	0.8	130	0.17	0.8	435	0.20	0.8	-	-	-	
	T9310	0.4	285	0.12	0.8	-	-	-	270	0.12	0.8	-	-	-	-	-	-	
	T9315	0.4	255	0.12	0.8	-	-	-	240	0.12	0.8	-	-	-	-	-	-	
	T9325	0.4	190	0.18	0.8	110	0.16	0.8	180	0.18	0.8	-	-	-	-	-	-	
DCMT 11T308E-FM	T7325	0.8	185	0.17	0.8	140	0.15	0.8	-	-	-	-	-	-	-	-	-	
	T7335	0.8	180	0.17	0.8	140	0.15	0.8	-	-	-	-	-	-	-	-	-	
	T8315	0.8	170	0.17	0.8	100	0.15	0.8	160	0.17	0.8	510	0.20	0.8	-	-	-	
	T8330	0.8	165	0.17	0.8	95	0.15	0.8	155	0.17	0.8	495	0.20	0.8	-	-	-	
	T8430	0.8	190	0.17	0.8	105	0.15	0.8	155	0.17	0.8	525	0.20	0.8	-	-	-	
	T9310	0.8	285	0.17	0.8	-	-	-	270	0.17	0.8	-	-	-	-	-	-	
	T9315	0.8	260	0.17	0.8	-	-	-	245	0.17	0.8	-	-	-	-	-	-	
	T9325	0.8	235	0.17	0.8	140	0.15	0.8	220	0.17	0.8	-	-	-	-	-	-	
DCMT 11T312E-FM	T8330	1.2	150	0.22	1.2	90	0.22	1.2	140	0.22	1.2	450	0.26	1.2	-	-	-	
	T8430	1.2	175	0.22	1.2	95	0.22	1.2	140	0.22	1.2	480	0.26	1.2	-	-	-	
	T9315	1.2	235	0.22	1.2	-	-	-	220	0.22	1.2	-	-	-	-	-	-	
	T9325	1.2	210	0.22	1.2	125	0.22	1.2	195	0.22	1.2	-	-	-	-	-	-	

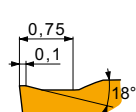

FM2 geometria per operazioni da finitura fino a lavorazioni medie, da taglio continuo a interrotto.

DCMT 070204E-FM2	T6310	0.4	135	0.12	0.8	95	0.11	0.8	105	0.12	0.8	-	-	-	-	-	-
	T7325	0.4	160	0.12	0.8	120	0.11	0.8	-	-	-	-	-	-	-	-	-
	T8330	0.4	135	0.12	0.8	80	0.11	0.8	125	0.12	0.8	-	-	-	-	-	-
	T8430	0.4	170	0.12	0.8	90	0.11	0.8	135	0.12	0.8	-	-	-	-	-	-
	T9315	0.4	230	0.12	0.8	-	-	-	215	0.12	0.8	-	-	-	-	-	-
T9325	0.4	205	0.12	0.8	120	0.11	0.8	190	0.12	0.8	-	-	-	-	-	-	
DCMT 11T304E-FM2	T6310	0.4	135	0.12	0.8	95	0.11	0.8	105	0.12	0.8	-	-	-	-	-	-
	T7325	0.4	160	0.12	0.8	120	0.11	0.8	-	-	-	-	-	-	-	-	-
	T8330	0.4	135	0.12	0.8	80	0.11	0.8	125	0.12	0.8	-	-	-	-	-	-
	T8430	0.4	170	0.12	0.8	90	0.11	0.8	135	0.12	0.8	-	-	-	-	-	-
	T9315	0.4	230	0.12	0.8	-	-	-	215	0.12	0.8	-	-	-	-	-	-
	T9325	0.4	205	0.12	0.8	120	0.11	0.8	190	0.12	0.8	-	-	-	-	-	-
	T9335	0.4	175	0.12	0.8	105	0.11	0.8	-	-	-	-	-	-	-	-	-



Idoneità e valori iniziali per velocità di taglio (Vc), avanzamento (f) e profondità di taglio (ap). Fare riferimento alla nostra App Machining Calculator per ulteriori calcoli.

Codice prodotto	RE  (mm)	P			M			K			N			S			H		
		vc (m/min)	f (mm/rev)	ap (mm)	vc (m/min)	f (mm/rev)	ap (mm)	vc (m/min)	f (mm/rev)	ap (mm)	vc (m/min)	f (mm/rev)	ap (mm)	vc (m/min)	f (mm/rev)	ap (mm)	vc (m/min)	f (mm/rev)	ap (mm)

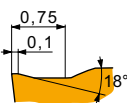

FM2 geometria per operazioni da finitura fino a lavorazioni medie, da taglio continuo a interrotto.

DCMT 11T308E-FM2	T6310	0.8	█	150	0.17	0.8	█	105	0.15	0.8	█	120	0.17	0.8	–	–	–	–	–	–
	T7325	0.8	█	170	0.17	0.8	█	130	0.15	0.8	–	–	–	–	–	–	–	–	–	–
	T8330	0.8	█	150	0.17	0.8	█	90	0.15	0.8	█	140	0.17	0.8	–	–	–	–	–	–
	T8430	0.8	█	175	0.17	0.8	█	95	0.15	0.8	█	140	0.17	0.8	–	–	–	–	–	–
	T9315	0.8	█	235	0.17	0.8	–	–	–	–	█	220	0.17	0.8	–	–	–	–	–	–
	T9325	0.8	█	215	0.17	0.8	█	125	0.15	0.8	█	200	0.17	0.8	–	–	–	–	–	–
	T9335	0.8	█	180	0.17	0.8	█	105	0.15	0.8	–	–	–	–	–	–	–	–	–	–
DCMT 11T312E-FM2	T8430	1.2	█	155	0.22	1.2	█	85	0.20	1.2	█	130	0.22	1.2	–	–	–	–	–	–
	T9325	1.2	█	190	0.22	1.2	█	110	0.20	1.2	█	180	0.22	1.2	–	–	–	–	–	–
DCMT 150408E-FM2	T9315	0.8	█	205	0.20	1.5	–	–	–	–	█	190	0.20	1.5	–	–	–	–	–	–
	T9325	0.8	█	185	0.20	1.5	█	110	0.18	1.5	█	175	0.20	1.5	–	–	–	–	–	–
	T9335	0.8	█	160	0.20	1.5	█	95	0.18	1.5	–	–	–	–	–	–	–	–	–	

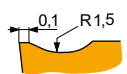

RF geometria per operazioni da semi sgrassatura fino a sgrassatura, da taglio continuo a interrotto.

DCMT 11T304E-RF	T5315	0.4	█	175	0.20	0.8	–	–	–	–	█	165	0.20	0.8	–	–	–	–	█	35	0.15	1.0	
	T7335	0.4	█	115	0.20	0.8	█	85	0.18	0.8	–	–	–	–	–	–	–	–	–	–	–		
	T9325	0.4	█	150	0.20	0.8	█	90	0.18	0.8	█	140	0.20	0.8	–	–	–	–	–	–	–		
DCMT 11T308E-RF	T5315	0.8	█	205	0.20	0.8	–	–	–	–	█	190	0.20	0.8	–	–	–	–	–	█	40	0.15	1.0
	T7335	0.8	█	140	0.20	0.8	█	105	0.18	0.8	–	–	–	–	–	–	–	–	–	–	–		
	T9325	0.8	█	175	0.20	0.8	█	105	0.18	0.8	█	165	0.20	0.8	–	–	–	–	–	–	–		

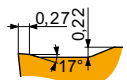

RM geometria per operazioni da semi sgrassatura fino a sgrassatura, da taglio continuo a interrotto.

DCMT 11T304E-RM	T5305	0.4	█	225	0.27	0.8	–	–	–	–	█	210	0.27	0.8	–	–	–	–	–	█	45	0.15	1.0	
	T5315	0.4	█	205	0.27	0.8	–	–	–	–	█	190	0.27	0.8	–	–	–	–	–	–	█	40	0.15	1.0
	T7335	0.4	█	135	0.27	0.8	█	105	0.24	0.8	–	–	–	–	█	40	0.19	0.6	–	–	–	–		
	T8330	0.4	█	125	0.27	0.8	█	75	0.24	0.8	█	115	0.27	0.8	–	–	–	–	–	█	25	0.15	1.0	
	T8430	0.4	█	135	0.27	0.8	█	75	0.24	0.8	█	110	0.27	0.8	–	–	–	–	–	█	20	0.15	1.0	
	T9315	0.4	█	185	0.27	0.8	–	–	–	–	█	175	0.27	0.8	–	–	–	–	–	–	█	35	0.15	1.0
	T9325	0.4	█	165	0.27	0.8	█	95	0.24	0.8	█	155	0.27	0.8	–	–	–	–	–	█	35	0.19	0.6	
DCMT 11T308E-RM	T5305	0.8	█	270	0.27	0.8	–	–	–	–	█	255	0.27	0.8	–	–	–	–	–	–	█	50	0.15	1.0
	T5315	0.8	█	240	0.27	0.8	–	–	–	–	█	225	0.27	0.8	–	–	–	–	–	–	█	45	0.15	1.0
	T7335	0.8	█	165	0.27	0.8	█	125	0.24	0.8	–	–	–	–	█	50	0.19	0.6	–	–	–	–		
	T8330	0.8	█	150	0.27	0.8	█	90	0.24	0.8	█	140	0.27	0.8	–	–	–	–	–	█	30	0.15	1.0	
	T8430	0.8	█	165	0.27	0.8	█	90	0.24	0.8	█	135	0.27	0.8	–	–	–	–	–	█	25	0.15	1.0	
	T9315	0.8	█	220	0.27	0.8	–	–	–	–	█	205	0.27	0.8	–	–	–	–	–	–	█	40	0.15	1.0
	T9325	0.8	█	200	0.27	0.8	█	120	0.24	0.8	█	190	0.27	0.8	–	–	–	–	–	█	45	0.19	0.6	
DCMT 11T312E-RM	T7335	1.2	█	165	0.27	1.2	█	125	0.24	1.2	–	–	–	–	█	50	0.19	1.2	–	–	–	–		
	T8330	1.2	█	150	0.27	1.2	█	90	0.24	1.2	█	140	0.27	1.2	–	–	–	–	–	█	30	0.15	1.0	
	T8430	1.2	█	170	0.27	1.2	█	90	0.24	1.2	█	135	0.27	1.2	–	–	–	–	–	█	25	0.15	1.0	
	T9315	1.2	█	225	0.27	1.2	–	–	–	–	█	210	0.27	1.2	–	–	–	–	–	–	█	45	0.15	1.0
	T9325	1.2	█	200	0.27	1.2	█	120	0.24	1.2	█	190	0.27	1.2	–	–	–	–	–	█	45	0.19	1.2	
DCMT 150408E-RM	T8330	0.8	█	135	0.27	1.9	█	80	0.24	1.9	█	125	0.27	1.9	–	–	–	–	–	█	25	0.15	1.0	
	T8430	0.8	█	150	0.27	1.9	█	80	0.24	1.9	█	125	0.27	1.9	–	–	–	–	–	█	25	0.15	1.0	
	T9315	0.8	█	200	0.27	1.9	–	–	–	–	█	190	0.27	1.9	–	–	–	–	–	–	█	40	0.15	1.0
	T9325	0.8	█	180	0.27	1.9	█	105	0.24	1.9	█	170	0.27	1.9	–	–	–	–	–	█	40	0.22	1.5	



Idoneità e valori iniziali per velocità di taglio (Vc), avanzamento (f) e profondità di taglio (ap). Fare riferimento alla nostra App Machining Calculator per ulteriori calcoli.

Codice prodotto	RE  (mm)	P			M			K			N			S			H		
		vc (m/min)	f (mm/rev)	ap (mm)	vc (m/min)	f (mm/rev)	ap (mm)	vc (m/min)	f (mm/rev)	ap (mm)	vc (m/min)	f (mm/rev)	ap (mm)	vc (m/min)	f (mm/rev)	ap (mm)	vc (m/min)	f (mm/rev)	ap (mm)

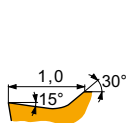

UR geometria per lavorazioni leggere e finitura, da taglio continuo a leggermente interrotto.

DCMT 070202E-UR	T7325	0.2	✓	150	0.10	0.8	✓	115	0.09	0.8	■	125	0.10	0.8	-	-	-	-	-	-
	T8315	0.2	✓	135	0.10	0.8	✓	80	0.09	0.8	■	125	0.10	0.8	-	-	-	-	-	-
	T8330	0.2	■	130	0.10	0.8	✓	75	0.09	0.8	■	120	0.10	0.8	-	-	-	-	-	-
	T8430	0.2	■	155	0.10	0.8	✓	85	0.09	0.8	✓	130	0.10	0.8	-	-	-	-	-	-
	T9315	0.2	■	220	0.10	0.8	-	-	-	✓	205	0.10	0.8	-	-	-	-	-	-	-
	T9325	0.2	■	200	0.10	0.8	✓	120	0.09	0.8	✓	190	0.10	0.8	-	-	-	-	-	-
DCMT 070204E-UR	T7325	0.4	✓	135	0.17	0.8	✓	105	0.15	0.8	-	-	-	-	-	-	-	-	-	
	T8315	0.4	✓	135	0.12	0.8	✓	80	0.11	0.8	■	125	0.12	0.8	-	-	-	-	-	
	T8330	0.4	■	130	0.12	0.8	✓	75	0.11	0.8	■	120	0.12	0.8	-	-	-	-	-	
	T8430	0.4	■	155	0.12	0.8	✓	85	0.11	0.8	✓	130	0.12	0.8	-	-	-	-	-	
	T9315	0.4	■	220	0.12	0.8	-	-	-	✓	205	0.12	0.8	-	-	-	-	-	-	
	T9325	0.4	■	165	0.18	0.8	✓	95	0.16	0.8	✓	155	0.18	0.8	-	-	-	-	-	
DCMT 11T302E-UR	T7325	0.2	✓	150	0.10	0.8	✓	115	0.09	0.8	-	-	-	-	-	-	-	-	-	
	T8330	0.2	■	130	0.10	0.8	✓	75	0.09	0.8	■	120	0.10	0.8	-	-	-	-	-	
	T8430	0.2	■	155	0.10	0.8	✓	85	0.09	0.8	✓	130	0.10	0.8	-	-	-	-	-	
	T9315	0.2	■	220	0.10	0.8	-	-	-	✓	205	0.10	0.8	-	-	-	-	-	-	
	T9325	0.2	■	200	0.10	0.8	✓	120	0.09	0.8	✓	190	0.10	0.8	-	-	-	-	-	
	TT310	0.2	■	210	0.10	0.8	✓	125	0.09	0.8	-	-	-	-	-	-	-	-	-	
DCMT 11T304E-UR	T5315	0.4	✓	220	0.12	0.8	-	-	-	■	205	0.12	0.8	-	-	-	-	-	-	
	T7325	0.4	✓	135	0.17	0.8	✓	105	0.15	0.8	-	-	-	-	-	-	-	-		
	T7335	0.4	✓	130	0.17	0.8	✓	100	0.15	0.8	-	-	-	-	-	-	-	-		
	T8315	0.4	✓	135	0.12	0.8	✓	80	0.11	0.8	■	125	0.12	0.8	-	-	-	-	-	
	T8330	0.4	■	130	0.12	0.8	✓	75	0.11	0.8	■	120	0.12	0.8	-	-	-	-	-	
	T8430	0.4	■	155	0.12	0.8	✓	85	0.11	0.8	✓	130	0.12	0.8	-	-	-	-	-	
	T9315	0.4	■	220	0.12	0.8	-	-	-	✓	205	0.12	0.8	-	-	-	-	-	-	
	T9325	0.4	■	165	0.18	0.8	✓	95	0.16	0.8	✓	155	0.18	0.8	-	-	-	-	-	
	TT310	0.4	■	210	0.12	0.8	✓	125	0.11	0.8	-	-	-	-	-	-	-	-		
	DCMT 11T308E-UR	T5315	0.8	✓	230	0.17	0.8	-	-	-	■	215	0.17	0.8	-	-	-	-	-	
T7325		0.8	✓	160	0.17	0.8	✓	120	0.15	0.8	-	-	-	-	-	-	-	-		
T7335		0.8	✓	155	0.17	0.8	✓	120	0.15	0.8	-	-	-	-	-	-	-	-		
T8315		0.8	✓	145	0.17	0.8	✓	85	0.15	0.8	■	135	0.17	0.8	-	-	-	-		
T8330		0.8	■	140	0.17	0.8	✓	80	0.15	0.8	■	130	0.17	0.8	-	-	-	-		
T8430		0.8	■	165	0.17	0.8	✓	90	0.15	0.8	✓	135	0.17	0.8	-	-	-	-		
T9315		0.8	■	225	0.17	0.8	-	-	-	✓	210	0.17	0.8	-	-	-	-	-		
T9325		0.8	■	200	0.17	0.8	✓	120	0.15	0.8	✓	190	0.17	0.8	-	-	-	-		
TT310		0.8	■	225	0.17	0.8	✓	135	0.15	0.8	-	-	-	-	-	-	-			
DCMT 11T312E-UR		T9315	1.2	■	205	0.22	1.2	-	-	-	✓	190	0.22	1.2	-	-	-	-	-	
	T9325	1.2	■	180	0.22	1.2	✓	105	0.20	1.2	✓	170	0.22	1.2	-	-	-	-		

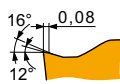

W-FM geometria wiper per lavorazioni leggere e finitura con maggiore velocità di avanzamento e finitura superficiale ottimizzata.

DCMX 11T304W-FM	T7325	0.4	✓	130	0.30	0.8	■	100	0.27	0.8	-	-	-	-	-	-	-	-
	T8330	0.4	■	115	0.30	0.8	■	65	0.27	0.8	■	105	0.30	0.8	-	-	-	-
	T8430	0.4	■	130	0.30	0.8	■	70	0.27	0.8	✓	105	0.30	0.8	-	-	-	-
	T9315	0.4	■	170	0.30	0.8	-	-	-	✓	160	0.30	0.8	-	-	-	-	-
	T9325	0.4	■	155	0.30	0.8	■	90	0.27	0.8	✓	145	0.30	0.8	-	-	-	-
DCMX 11T308W-FM	T7325	0.8	✓	140	0.40	1.0	■	105	0.36	1.0	-	-	-	-	-	-	-	
	T8430	0.8	■	130	0.40	1.0	■	70	0.36	1.0	✓	105	0.40	1.0	-	-	-	
	T9315	0.8	■	175	0.40	1.0	-	-	-	✓	165	0.40	1.0	-	-	-	-	
	T9325	0.8	■	160	0.40	1.0	■	95	0.36	1.0	✓	150	0.40	1.0	-	-	-	



DCMW



	IC	D1	L	S
	(mm)	(mm)	(mm)	(mm)
0702	6.350	2.80	7.80	2.38
11T3	9.525	4.40	11.60	3.97

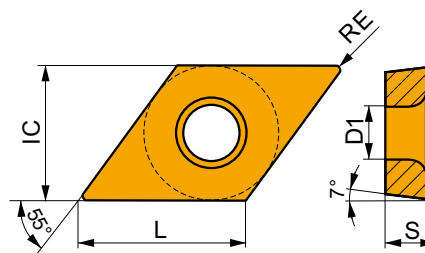

Idoneità e valori iniziali per velocità di taglio (Vc), avanzamento (f) e profondità di taglio (ap). Fare riferimento alla nostra App Machining Calculator per ulteriori calcoli.

Codice prodotto	RE	P			M			K			N			S			H		
		vc	f	ap	vc	f	ap	vc	f	ap	vc	f	ap	vc	f	ap	vc	f	ap
	(mm)	(m/min)	(mm/rev)	(mm)	(m/min)	(mm/rev)	(mm)	(m/min)	(mm/rev)	(mm)	(m/min)	(mm/rev)	(mm)	(m/min)	(mm/rev)	(mm)	(m/min)	(mm/rev)	(mm)



Adatta per operazioni da finitura fino a semi sgrossatura, da taglio continuo a leggermente interrotto.

DCMW 070202	T5305	0.2	-	-	-	-	-	-	200	0.08	0.8	-	-	-	-	-	-	40	0.15	1.0
	T6310	0.2	-	-	-	-	-	-	80	0.08	0.8	-	-	-	-	-	-	20	0.15	1.0
DCMW 070204	T5305	0.4	-	-	-	-	-	-	195	0.10	0.8	-	-	-	-	-	-	40	0.15	1.0
	T5315	0.4	-	-	-	-	-	-	175	0.10	0.8	-	-	-	-	-	-	35	0.15	1.0
	T6310	0.4	-	-	-	-	-	-	85	0.10	0.8	-	-	-	-	-	-	20	0.15	1.0
DCMW 11T304	T5305	0.4	-	-	-	-	-	-	190	0.10	1.2	-	-	-	-	-	-	40	0.15	1.0
	T5315	0.4	-	-	-	-	-	-	165	0.10	1.2	-	-	-	-	-	-	35	0.15	1.0
	T6310	0.4	-	-	-	-	-	-	80	0.10	1.2	-	-	-	-	-	-	20	0.15	1.0
DCMW 11T308	T5305	0.8	-	-	-	-	-	-	185	0.18	1.2	-	-	-	-	-	-	35	0.15	1.0
	T5315	0.8	-	-	-	-	-	-	160	0.18	1.2	-	-	-	-	-	-	30	0.15	1.0
	T6310	0.8	-	-	-	-	-	-	80	0.18	1.2	-	-	-	-	-	-	20	0.15	1.0

DCGW CBN



	IC	D1	L	S
	(mm)	(mm)	(mm)	(mm)
11T3	9.525	4.50	11.60	3.97

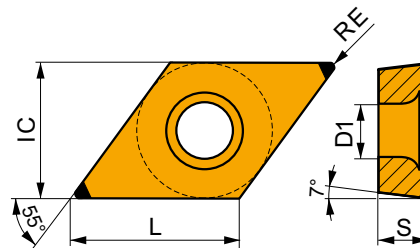

Idoneità e valori iniziali per velocità di taglio (Vc), avanzamento (f) e profondità di taglio (ap). Fare riferimento alla nostra App Machining Calculator per ulteriori calcoli.

Codice prodotto	RE	P			M			K			N			S			H		
		vc	f	ap	vc	f	ap	vc	f	ap	vc	f	ap	vc	f	ap	vc	f	ap
	(mm)	(m/min)	(mm/rev)	(mm)	(m/min)	(mm/rev)	(mm)	(m/min)	(mm/rev)	(mm)	(m/min)	(mm/rev)	(mm)	(m/min)	(mm/rev)	(mm)	(m/min)	(mm/rev)	(mm)

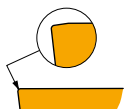
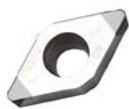

Adatta per operazioni di finitura.

DCGW 11T304S01020B	TB310	0.4	-	-	-	-	-	-	370	0.10	0.4	-	-	-	95	0.07	0.3	75	0.15	1.0
DCGW 11T308S01020B	TB310	0.8	-	-	-	-	-	-	380	0.15	0.6	-	-	-	100	0.11	0.5	80	0.15	1.0



DCMW PCD

	IC	D1	L	S
	(mm)	(mm)	(mm)	(mm)
11T3	9.525	4.40	11.60	3.97

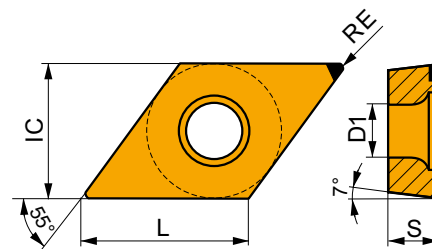

Idoneità e valori iniziali per velocità di taglio (Vc), avanzamento (f) e profondità di taglio (ap). Fare riferimento alla nostra App Machining Calculator per ulteriori calcoli.

Codice prodotto	RE	P			M			K			N			S			H			
		vc	f	ap	vc	f	ap	vc	f	ap	vc	f	ap	vc	f	ap	vc	f	ap	
	(mm)	(m/min)	(mm/rev)	(mm)	(m/min)	(mm/rev)	(mm)	(m/min)	(mm/rev)	(mm)	(m/min)	(mm/rev)	(mm)	(m/min)	(mm/rev)	(mm)	(m/min)	(mm/rev)	(mm)	



Adatta per operazioni di finitura con elevata velocità e condizioni di taglio stabili.

DCMW 11T304FN	PD1	0.4	–	–	–	–	–	–	–	–	–	–	–	–	–	–	–	–	–	–	–
DCMW 11T308FN	PD1	0.8	–	–	–	–	–	–	–	–	–	–	–	–	–	–	–	–	–	–	–



SDJC(RL) EXT

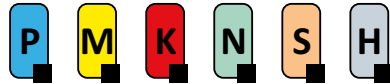

PRAMET

S



Utensile esterno, bloccaggio a vite, inserti DC... angolo del tagliente utensile 93°

Utensile di tornitura esterna destro/sinistro con bloccaggio a vite, angolo del tagliente utensile 93° per inserti positivi DC...07, 11 o 15. Adatto per operazioni di tornitura longitudinale con spallamento, copiatura, conicità e smussi. Disponibile con stelo da 08x08 a 25x25 mm. Corpo trattato per una maggiore durata.

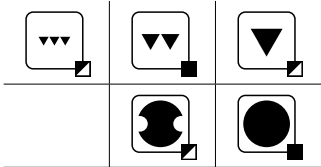
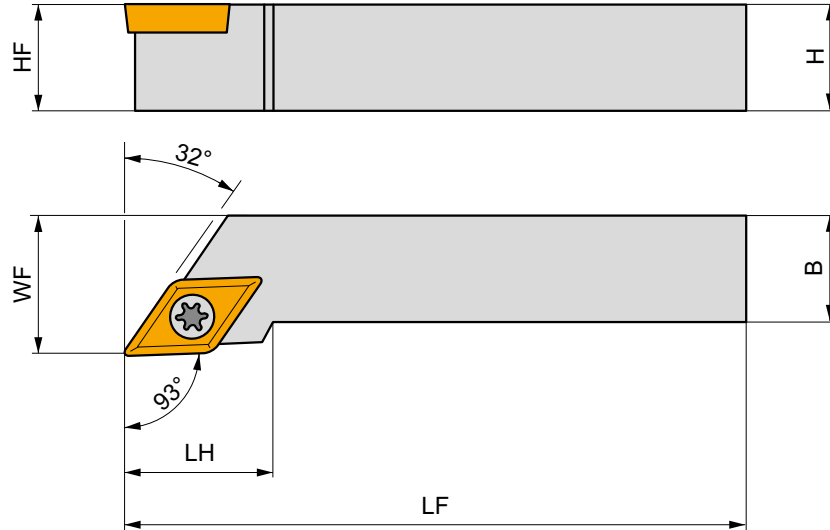
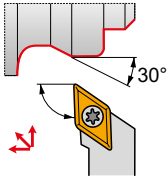

Codice prodotto	H	B	HF	WF	LF	LH	LAMS	GAMO	kg		
	(mm)	(mm)	(mm)	(mm)	(mm)	(mm)	(°)	(°)			
R SDJCR 0808 D 07	8	8	8	10	60	14	0	0	0.06	GI052	S01
SDJCR 1010 E 07	10	10	10	12	70	14	0	0	0.06	GI052	S01
SDJCR 1212 F 07	12	12	12	16	80	14	0	0	0.11	GI052	S01
SDJCR 1212 F 11	12	12	12	16	80	20	0	0	0.10	GI012	S08
SDJCR 1616 H 11	16	16	16	20	100	20	0	0	0.22	GI012	S08
SDJCR 2020 K 11-M-A	20	20	20	25	125	20	0	0	0.40	GI012	SD10
SDJCR 2525 M 11-M-A	25	25	25	32	150	20	0	0	0.74	GI012	SD10
SDJCR 2525 M 15	25	25	25	32	150	28	0	0	0.75	GI243	SD11
L SDJCL 0808 D 07	8	8	8	10	60	14	0	0	0.04	GI052	S01
SDJCL 1010 E 07	10	10	10	12	70	14	0	0	0.08	GI052	S01
SDJCL 1212 F 07	12	12	12	16	80	14	0	0	0.12	GI052	S01
SDJCL 1212 F 11	12	12	12	16	80	20	0	0	0.12	GI012	S08
SDJCL 1616 H 11	16	16	16	20	100	20	0	0	0.20	GI012	S08
SDJCL 2020 K 11-M-A	20	20	20	25	125	20	0	0	0.41	GI012	SD10
SDJCL 2525 M 11-M-A	25	25	25	32	150	20	0	0	0.74	GI012	SD10
SDJCL 2525 M 15	25	25	25	32	150	28	0	0	0.07	GI243	SD11



GI012	DC.. 11T3..
GI052	DC.. 0702..
GI243	DC.. 1504..



SD10	US 3510-T15P	3.0	M 3.5	10.6	SDN 110304	MS 3510	FLAG T15P	HXK 3.5
SD11	US 64518-T15P	5.0	M 4.5	18	SDN 150304	MS 4512	FLAG T15P	HXK 5
S01	US 2506-T07P	0.9	M 2.5	6.3	-	-	FLAG T07P	-
S08	US 3510-T15P	3.0	M 3.5	10.6	-	-	FLAG T15P	-



SDNCN EXT



Utensile esterno, bloccaggio a vite, angolo del tagliente utensile 62,5°, inserti DC..

Utensile esterno di tornitura neutro con angolo del tagliente utensile di 62,5° per inserti DC.. 07 o 11 positivi, bloccaggio a vite. Adatto per tornitura longitudinale esterna senza spallamento, copiatura, conicità e smussi. Disponibile con misura stelo da 08x08 fino a 25x25 mm. Corpo trattato per una maggiore durata dell'utensile.

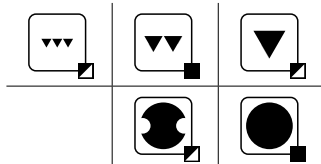
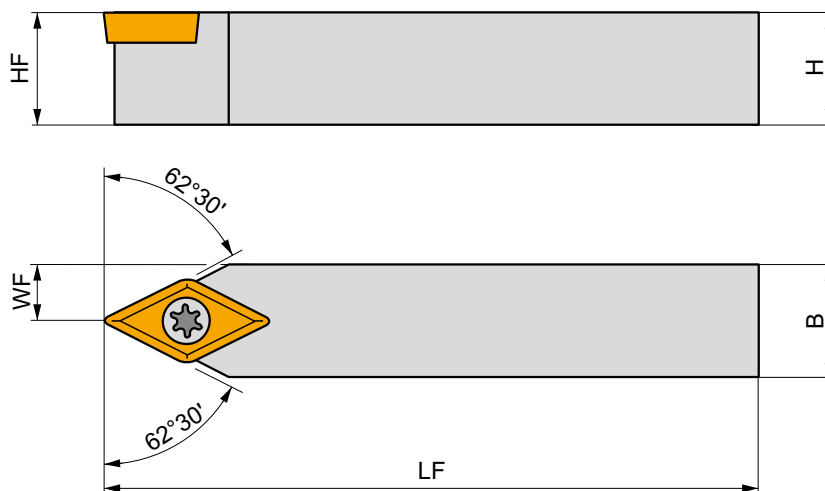
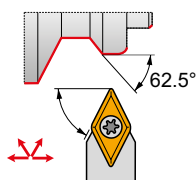

Codice prodotto	H (mm)	B (mm)	HF (mm)	WF (mm)	LF (mm)	LAMS (°)	GAMO (°)	kg		
N SDNCN 0808 D 07	8	8	8	4	60	0	0	0.06	GI052	S01
SDNCN 1010 E 07	10	10	10	5	70	0	0	0.08	GI052	S01
SDNCN 1212 F 07	12	12	12	6	80	0	0	0.12	GI052	S01
SDNCN 1212 F 11	12	12	12	6	80	0	0	0.12	GI012	S08
SDNCN 1616 H 11	16	16	16	8	100	0	0	0.18	GI012	S08
SDNCN 2020 K 11-M-A	20	20	20	10	125	0	0	0.35	GI012	SD10
SDNCN 2525 M 11-M-A	25	25	25	12.5	150	0	0	0.70	GI012	SD10



GI012

DC.. 11T3..

GI052

DC.. 0702..



SD10

US 3510-T15P

3.0

M 3.5

10.6

SDN 110304

MS 3510

FLAGT15P

HXK 3.5

S01

US 2506-T07P

0.9

M 2.5

6.3

-

-

FLAGT07P

-

S08

US 3510-T15P

3.0

M 3.5

10.6

-

-

FLAGT15P

-



NEW

C.-SDJC(RL) EXT

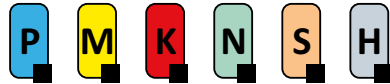

PRAMET

S



Utensile PSC esterno a cambio rapido, bloccaggio a vite per inserto DC... angolo del tagliente ut. 93°

Utensile destro/sinistro per tornitura esterna con bloccaggio a vite e passaggio refrigerante interno, angolo del tagliente utensile 93° per inserti positivi DC... 11. Adatto per la tornitura esterna longitudinale, spallamenti, copiatura e smussi. Disponibile con attacco PSC (Attacco Poligonale) da C3 a C5. Corpo trattato per una maggiore durata.

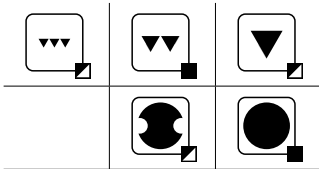
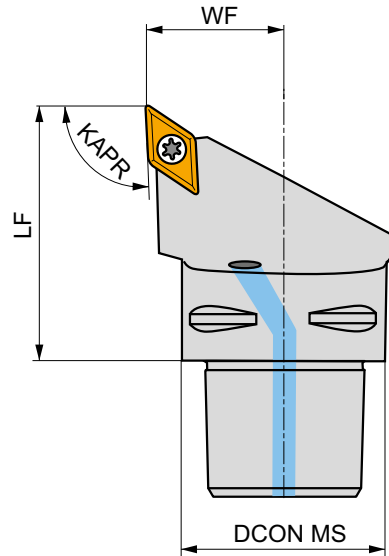
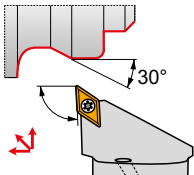

Codice prodotto	DCON MS (mm)	WF (mm)	LF (mm)	KAPR (°)	LAMS (°)	GAMO (°)		kg		
R C3-SDJCR-22040-11	32	22	40	93	0	0	✓	0.21	GI012	C-SD11V-1
C4-SDJCR-27050-11	40	27	50	93	0	0	✓	0.38	GI012	C-SD11V-1
C5-SDJCR-35060-11	50	35	60	93	0	0	✓	0.69	GI012	C-SD11V-2
L C3-SDJCL-22040-11	32	22	40	93	0	0	✓	0.21	GI012	C-SD11V-1
C4-SDJCL-27050-11	40	27	50	93	0	0	✓	0.38	GI012	C-SD11V-1
C5-SDJCL-35060-11	50	35	60	93	0	0	✓	0.70	GI012	C-SD11V-2



GI012



DC.. 11T3..

C-SD11V-1	US 2001-T15P	3.0	M 3.5	12.1	SDS 263-01	MS 9001	FLAG T15P/3,5	CN 034-01
C-SD11V-2	US 2001-T15P	3.0	M 3.5	12.1	SDS 263-01	MS 9001	FLAG T15P/3,5	CN 034-02

NEW
C.-SDNCN EXT

PRAMET
S

Utensile PSC esterno a cambio rapido, bloccaggio a vite per inserto DC... angolo del tagliente ut. 62.5°

Utensile destro/sinistro per tornitura esterna con bloccaggio a vite e passaggio refrigerante interno, angolo del tagliente utensile 62.5° per inserti positivi DC... 11. Adatto per la tornitura esterna longitudinale, conicità, copiatura e smussi. Disponibile con attacco PSC (Attacco Poligonale) da C4 e C5. Corpo trattato per una maggiore durata.

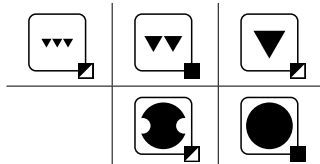
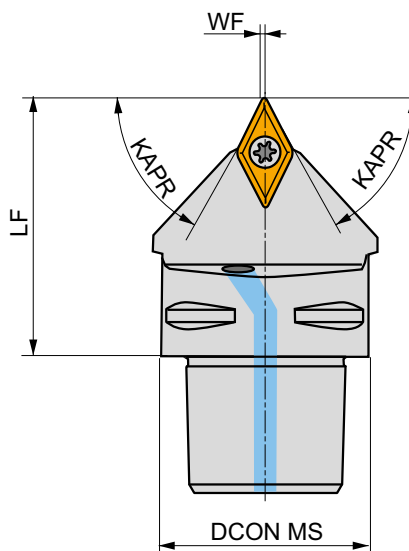
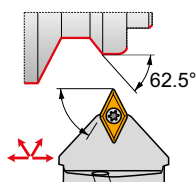

Codice prodotto	DCON MS	WF	LF	KAPR	LAMS	GAMO				
	(mm)	(mm)	(mm)	(°)	(°)	(°)				
N C4-SDNCN-00050-11	40	0.5	50	62.5	0	0	✓	0.35	GI012	C-SD11V-1
C5-SDNCN-00060-11	50	0.5	60	62.5	0	0	✓	0.62	GI012	C-SD11V-2



GI012



DC.. 11T3..

C-SD11V-1	US 2001-T15P	3.0	M 3.5	12.1	SDS 263-01	MS 9001	FLAG T15P/3,5	CN 034-01
C-SD11V-2	US 2001-T15P	3.0	M 3.5	12.1	SDS 263-01	MS 9001	FLAG T15P/3,5	CN 034-02



SDQC(RL) INT

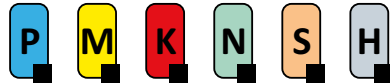

PRAMET

S



Utensile interno, bloccaggio a vite, inserti DC... angolo del tagliente utensile 107.5°

Bareno destro/sinistro per tornitura interna con bloccaggio a vite e passaggio refrigerante interno, angolo del tagliente utensile 107.5° per inserti positivi da DC...07 o 11. Diametro interno minimo tornibile Ø13 mm. Adatto per operazioni di tornitura longitudinale, spallamento, conicità e smussi. Disponibile con stelo da Ø10 mm a Ø32 mm. Corpo trattato per una maggiore durata.

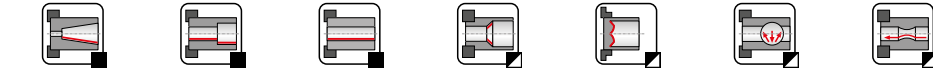
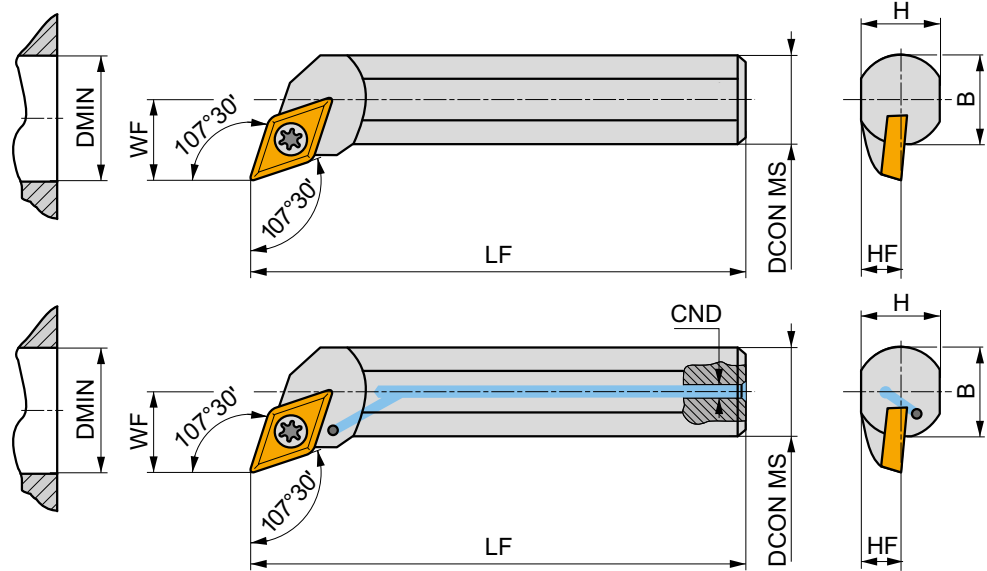
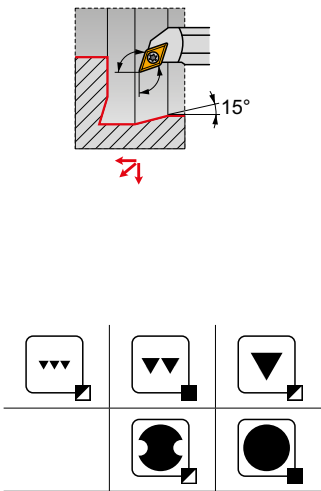

Codice prodotto	DCON MS	DMIN	WF	H	B	LF	CND	LAMS	GAMO	✓	kg	GI052	S02
	(mm)	(mm)	(mm)	(mm)	(mm)	(mm)	(mm)	(°)	(°)				
R A10H-SDQCR 07	10	13	7	9	-	100	4	-10	0	✓	0.07	GI052	S02
A12K-SDQCR 07	12	16	9	11	-	125	5	-7	0	✓	0.10	GI052	S02
A16M-SDQCR 07	16	20	11	14.5	-	150	6	-7	0	✓	0.24	GI052	S01
A20Q-SDQCR 11	20	25	13	18	-	180	8	-5	0	✓	0.40	GI012	S08
S20S-SDQCR 11	20	25	13	18	18.5	250	-	-5	0	-	0.60	GI012	S08
A25R-SDQCR 11	25	32	17	23	23	200	8	-3	0	✓	0.67	GI012	S08
S25T-SDQCR 11	25	32	17	23	23	300	-	-3	0	-	1.09	GI012	S08
A32S-SDQCR 11-A	32	40	22	30	30	250	8	-10	0	✓	1.25	GI012	SD10
S32U-SDQCR 11-A	32	40	22	30	30	350	-	-10	0	-	2.10	GI012	SD10
L A10H-SDQCL 07	10	13	7	9	-	100	4	-10	0	✓	0.06	GI052	S02
A12K-SDQCL 07	12	16	9	11	-	125	5	-7	0	✓	0.11	GI052	S02
A16M-SDQCL 07	16	20	11	14.5	-	150	6	-7	0	✓	0.24	GI052	S01
A20Q-SDQCL 11	20	25	13	18	-	180	8	-5	0	✓	0.37	GI012	S08
S20S-SDQCL 11	20	25	13	18	18.5	250	-	-5	0	-	0.63	GI012	S08
A25R-SDQCL 11	25	32	17	23	23	200	8	-3	0	✓	0.64	GI012	S08
S25T-SDQCL 11	25	32	17	23	23	300	-	-3	0	-	1.15	GI012	S08
A32S-SDQCL 11-A	32	40	22	30	30	250	8	-10	0	✓	1.33	GI012	SD10
S32U-SDQCL 11-A	32	40	22	30	30	350	-	-10	0	-	2.08	GI012	SD10

GI012	DC.. 11T3..
GI052	DC.. 0702..

SD10	US 3510-T15P	3.0	M 3.5	10.6	SDN 110304	MS 3510	FLAG T15P	HXK 3.5
S01	US 2506-T07P	0.9	M 2.5	6.3	-	-	FLAG T07P	-
S02	US 2505-T07P	0.9	M 2.5	5.2	-	-	FLAG T07P	-
S08	US 3510-T15P	3.0	M 3.5	10.6	-	-	FLAG T15P	-



SDUC(RL) INT



Utensile interno, bloccaggio a vite, inserti DC... angolo del tagliente utensile 93°

Bareno destro/sinistro per tornitura interna con bloccaggio a vite e passaggio refrigerante interno, angolo del tagliente utensile 93° per inserti positivi DC...07 o 11. Diametro interno minimo tornibile Ø13 mm. Adatto per operazioni di tornitura longitudinale, spallamento, conicità e smussi. Disponibile con stelo da Ø10 mm a Ø32 mm. Corpo trattato per una maggiore durata.

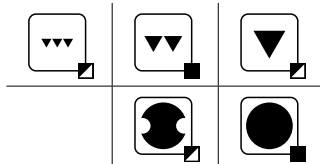
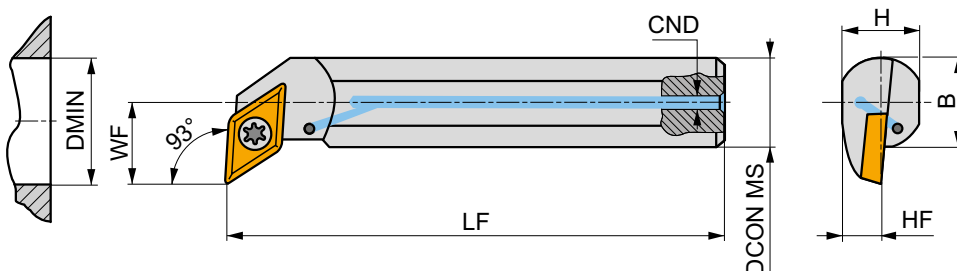
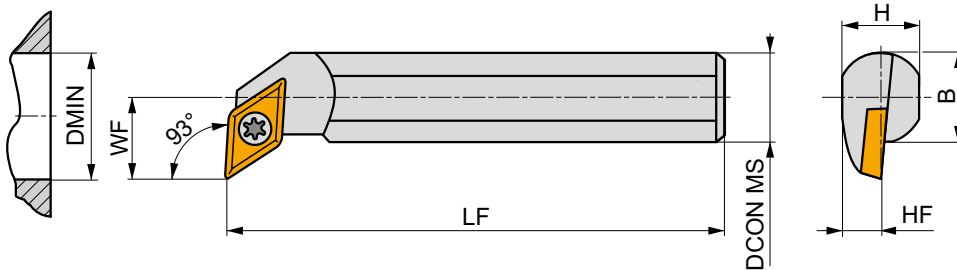
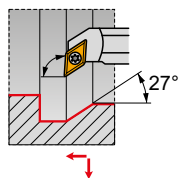

Codice prodotto	DCON MS	DMIN	WF	H	B	LF	CND	LAMS	GAMO					
	(mm)	(mm)	(mm)	(mm)	(mm)	(mm)	(°)	(°)						
R	A10H-SDUCR 07	10	13	7	9	-	100	4	-10	0	✓	0.05	GI052	S02
	A12K-SDUCR 07	12	16	9	11	-	125	5	-7	0	✓	0.12	GI052	S02
	A16M-SDUCR 07	16	20	11	14.5	-	150	6	-7	0	✓	0.22	GI052	S01
	A20Q-SDUCR 11	20	25	13	18	-	180	8	-3	0	✓	0.38	GI012	S08
	S20S-SDUCR 11	20	25	13	18	18.5	250	-	-5	0	-	0.60	GI012	S08
	A25R-SDUCR 11	25	32	17	23	23	200	8	-3	0	✓	0.60	GI012	S08
	S25T-SDUCR 11	25	32	17	23	23	300	-	-3	0	-	1.15	GI012	S08
	A32S-SDUCR 11-A	32	40	22	30	30	250	8	-10	0	✓	1.30	GI012	SD10
	S32U-SDUCR 11-A	32	40	22	30	30	350	-	-10	0	-	2.10	GI012	SD10
L	A10H-SDUCL 07	10	13	7	9	-	100	4	-10	0	✓	0.06	GI052	S02
	A12K-SDUCL 07	12	16	9	11	-	125	5	-7	0	✓	0.11	GI052	S02
	A16M-SDUCL 07	16	20	11	14.5	-	150	6	-7	0	✓	0.21	GI052	S01
	A20Q-SDUCL 11	20	25	13	18	-	180	8	-3	0	✓	0.38	GI012	S08
	S20S-SDUCL 11	20	25	13	18	18.5	250	-	-5	0	-	0.60	GI012	S08
	A25R-SDUCL 11	25	32	17	23	23	200	8	-3	0	✓	0.67	GI012	S08
	S25T-SDUCL 11	25	32	17	23	23	300	-	-3	0	-	1.15	GI012	S08
	A32S-SDUCL 11-A	32	40	22	30	30	250	8	-10	0	✓	1.35	GI012	SD10
	S32U-SDUCL 11-A	32	40	22	30	30	350	-	-10	0	-	2.09	GI012	SD10



GI012

DC.. 11T3..

GI052

DC.. 0702..



SD10

US 3510-T15P

3.0

M 3.5

10.6

SDN 110304

MS 3510

FLAG T15P

HXK 3.5

S01

US 2506-T07P

0.9

M 2.5

6.3

-

-

FLAG T07P

-

S02

US 2505-T07P

0.9

M 2.5

5.2

-

-

FLAG T07P

-

S08

US 3510-T15P

3.0

M 3.5

10.6

-

-

FLAG T15P

-



SDUC(RL)-E INT

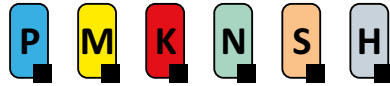

PRAMET

S



Utensile interno in metallo duro, bloccaggio a vite, per inserto DC... angolo del tagliente utensile 93°
 Bareno destro/sinistro in metallo duro per tornitura interna con bloccaggio a vite e passaggio refrigerante interno, angolo del tagliente utensile 93° per inserto positivo DC...07. Diametro interno minimo tornibile Ø15 mm. Adatto per operazioni di tornitura longitudinale, spallamento, conicità e smussi. Disponibile con stelo da Ø10 mm a Ø16 mm. Per sporgenze utensile >3xD.

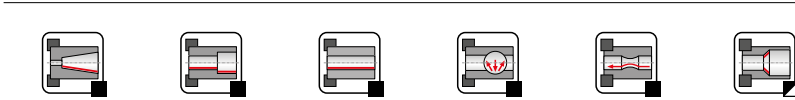
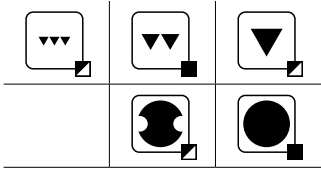
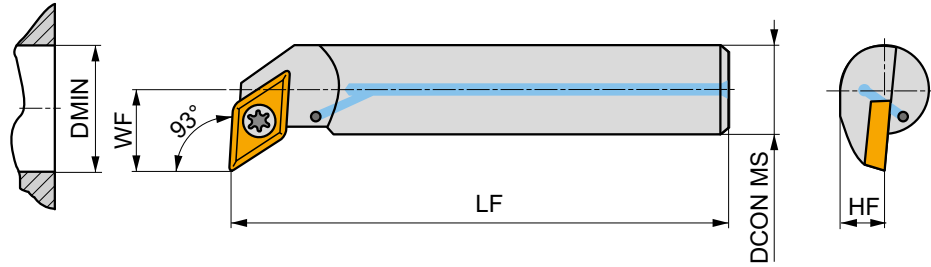
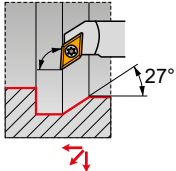

Codice prodotto	DCON MS (mm)	DMIN (mm)	WF (mm)	HF (mm)	LF (mm)	LAMS (°)	GAMO (°)				
R E10M-SDUCR 07-ER	10	15	9	5.6	150	-5	0	✓	0.14	GI052	SD21
E12Q-SDUCR 07-ER	12	18	11	6.5	150	-5	0	✓	0.26	GI052	SD21
E16R-SDUCR 07-ER	16	22	13	8.5	150	-5	0	✓	0.49	GI052	SD21
L E10M-SDUCL 07-ER	10	15	9	5.6	150	-5	0	✓	0.15	GI052	SD21
E12Q-SDUCL 07-ER	12	18	11	6.5	150	-5	0	✓	0.26	GI052	SD21
E16R-SDUCL 07-ER	16	22	13	8.5	150	-5	0	✓	0.50	GI052	SD21



SDZC(RL) INT



PRAMET

S

Utensile interno, bloccaggio a vite, inserti DC... angolo del tagliente utensile 93°

Bareno destro/sinistro per tornitura interna con bloccaggio a vite, angolo del tagliente utensile 93° per inserti positivi DC...07 o 11. Diametro interno minimo tornibile Ø27 mm. Adatto per operazioni di copiatura, tornitura in tirata longitudinale con spallamento, conicità e smussi. Disponibile con stelo da Ø16 mm a Ø40 mm. Corpo trattato per una maggiore durata.

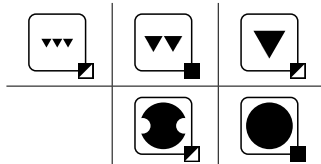
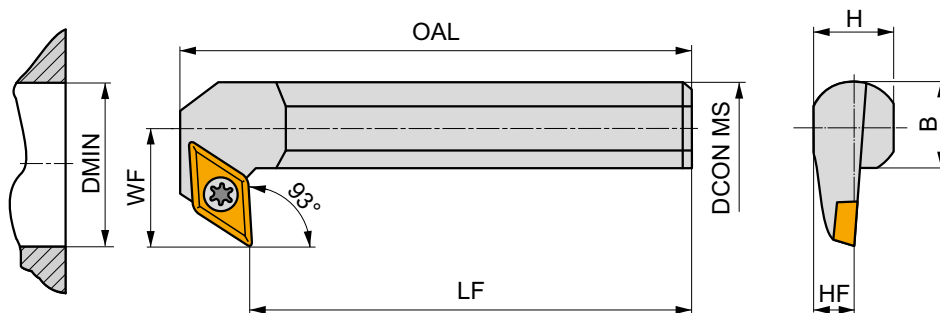
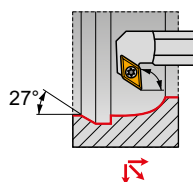

Codice prodotto	DCON MS (mm)	DMIN (mm)	WF (mm)	H (mm)	B (mm)	LF (mm)	OAL (mm)	LAMS (°)	GAMO (°)	kg			
R	S16M-SDZCR 07-93	16	27	17	14.5	15	150	163	-4	0	0.26	GI052	S01
	S20Q-SDZCR 11-93	20	35	22	18	18.5	180	198	-5	0	0.50	GI012	S08
	S25R-SDZCR 11-93	25	42	27	23	23	200	218	-3	0	0.83	GI012	S08
	S32S-SDZCR 11-93-A	32	53	35	30	30	250	268	-6	0	1.64	GI012	SD10
	S40T-SDZCR 11-93-A	40	65	43	38	38	300	322	-5	0	3.00	GI012	SD10
L	S16M-SDZCL 07-93	16	27	17	14.5	15	150	163	-4	0	0.27	GI052	S01
	S20Q-SDZCL 11-93	20	35	22	18	18.5	180	198	-5	0	0.60	GI012	S08
	S25R-SDZCL 11-93	25	42	27	23	23	200	218	-3	0	0.80	GI012	S08
	S32S-SDZCL 11-93-A	32	53	35	30	30	250	268	-6	0	1.60	GI012	SD10
	S40T-SDZCL 11-93-A	40	65	43	38	38	300	322	-5	0	3.00	GI012	SD10

GI012
GI052DC.. 11T3..
DC.. 0702..

SD10

US 3510-T15P

3.0

M 3.5

10.6

SDN 110304

MS 3510

FLAG T15P

HXK 3.5

S01

US 2506-T07P

0.9

M 2.5

6.3

-

-

FLAG T07P

-

S08

US 3510-T15P

3.0

M 3.5

10.6

-

-

FLAG T15P

-



NEW

C.-SDUC(RL) INT

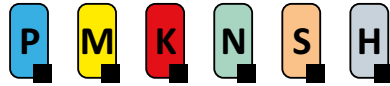

PRAMET

S



Utensile PSC interno a cambio rapido, bloccaggio a vite per inserto DC... angolo del tagliente ut. 93°

Utensile destro/sinistro per tornitura interna con bloccaggio a vite e passaggio refrigerante interno, angolo del tagliente utensile 93° per inserti positivi DC... 07 o 11. Diametro interno minimo tornibile Ø20 mm. Adatto per un'ampia gamma di applicazioni di tornitura interna. Attacco PSC (Attacco Poligonale) da C3 a C5 con lunghezze diverse. Corpo trattato per una maggiore durata.

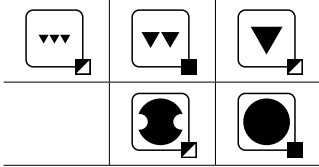
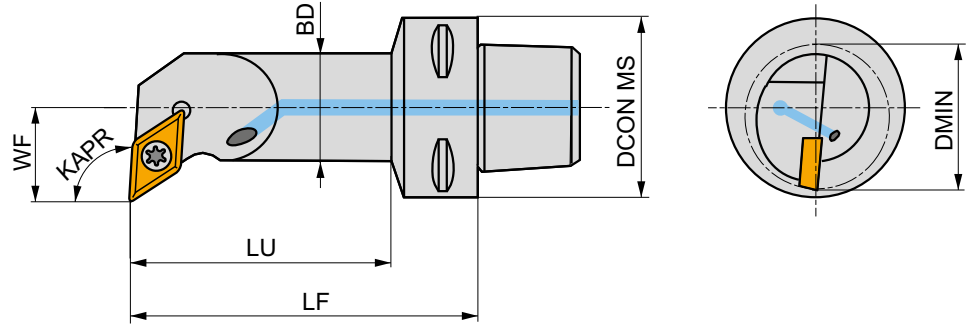
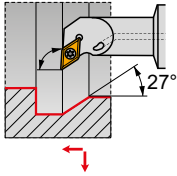

Codice prodotto	DCON MS (mm)	DMIN (mm)	WF (mm)	LF (mm)	LU (mm)	BD (mm)	KAPR (°)	LAMS (°)	GAMO (°)				
R C3-SDUCR-11065-07	50	20	11	65	48	16	93	-4.3	0	✓	0.20	GI052	SV11
C4-SDUCR-11070-07	40	20	11	70	47	16	93	-4.3	0	✓	0.35	GI052	SV11
C4-SDUCR-13080-11	40	25	13	80	57	20	93	-5.8	0	✓	0.41	GI012	SC09M
C4-SDUCR-17090-11	40	32	17	90	68	25	93	-3.4	0	✓	0.49	GI012	SV16
L C5-SDUCR-13080-11	50	25	13	80	56	20	93	-5.8	0	✓	0.60	GI012	SC09M
C5-SDUCR-17090-11	50	32	17	90	67	25	93	-3.4	0	✓	0.68	GI012	SV16
C4-SDUCL-11070-07	40	20	11	70	47	16	93	-4.3	0	✓	0.35	GI052	SV11
C4-SDUCL-13080-11	40	25	13	80	57	20	93	-5.8	0	✓	0.41	GI012	SC09M
C4-SDUCL-17090-11	40	32	17	90	68	25	93	-3.4	0	✓	0.49	GI012	SV16
C5-SDUCL-13080-11	50	25	13	80	56	20	93	-5.8	0	✓	0.60	GI012	SC09M



GI012	DC.. 11T3..
GI052	DC.. 0702..



SC09M	US 2009-T15P	3.0	M 3.5	8.1	FLAG T15P/3,5	-
SV11	US 2003-T07P	0.8	M 2.5	6.5	-	FLAG T07P
SV16	US 2010-T15P	3.0	M 3.5	10.1	-	FLAG T15P/3,5



EC

06 / 08

INSERTI IN METALLO DURO

ECGT

104

ECMT

105

ECMW

106

ABBINAMENTO DELLA DIMENSIONE CORRETTA (esempio)

Inserto

ECMT 060204E-FM2

Portainsero

S08K-SEUCR 06

TORNITURA ISO - ESTERNA

SEGC(RL) EXT

90°

EC..

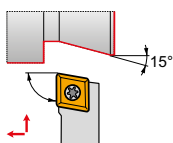

08

 $\frac{12 \times 12}{16 \times 16}$

107

104 – 106

TORNITURA ISO INTERNA

SEUC(RL) INT

93°

EC..



06

08

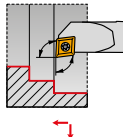
 $\frac{11}{32}$

108

104 – 106



ECGT



	IC	D1	L	S
	(mm)	(mm)	(mm)	(mm)
0602	6.350	2.80	6.50	2.38
0602-SF3	6.350	2.80	6.50	2.58
0803	7.940	3.40	8.20	3.18
0803-SF3	7.940	3.40	8.20	3.43

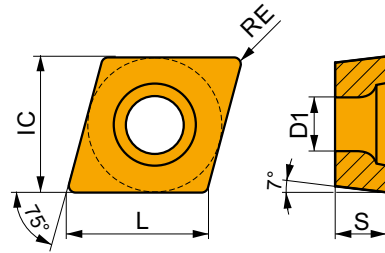

Idoneità e valori iniziali per velocità di taglio (Vc), avanzamento (f) e profondità di taglio (ap). Fare riferimento alla nostra App Machining Calculator per ulteriori calcoli.

Codice prodotto	RE (mm)	P			M			K			N			S			H		
		vc (m/min)	f (mm/rev)	ap (mm)	vc (m/min)	f (mm/rev)	ap (mm)	vc (m/min)	f (mm/rev)	ap (mm)	vc (m/min)	f (mm/rev)	ap (mm)	vc (m/min)	f (mm/rev)	ap (mm)			

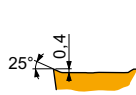

SF2 geometria con design altamente positivo per lavorazioni leggere e finitura, taglio continuo.

ECGT 060202E-SF2	H07	0.2	–	–	–	105	0.05	1.0	–	–	–	525	0.06	1.0	50	0.04	0.8	–	–	–
	T6310	0.2	185	0.05	1.0	130	0.05	1.0	–	–	–	555	0.06	1.0	55	0.04	0.8	–	–	–
ECGT 060204E-SF2	H07	0.4	–	–	–	85	0.09	1.0	–	–	–	430	0.12	1.0	40	0.07	0.8	–	–	–
	T6310	0.4	160	0.10	1.0	115	0.09	1.0	–	–	–	480	0.12	1.0	45	0.07	0.8	–	–	–
ECGT 080302E-SF2	H07	0.2	–	–	–	105	0.05	1.0	–	–	–	525	0.06	1.0	50	0.04	0.8	–	–	–
	T6310	0.2	185	0.05	1.0	130	0.05	1.0	–	–	–	555	0.06	1.0	55	0.04	0.8	–	–	–
ECGT 080304E-SF2	H07	0.4	–	–	–	85	0.09	1.0	–	–	–	430	0.12	1.0	40	0.07	0.8	–	–	–
	T6310	0.4	160	0.10	1.0	115	0.09	1.0	–	–	–	480	0.12	1.0	45	0.07	0.8	–	–	–

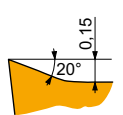

SF3 geometria con design altamente positivo per lavorazioni leggere e finitura, taglio continuo.

ECGT 060202E-SF3	H07	0.2	–	–	–	105	0.05	0.8	170	0.05	0.8	540	0.06	0.8	55	0.04	0.6	–	–	–
	T6310	0.2	185	0.05	0.8	130	0.05	0.8	145	0.05	0.8	555	0.06	0.8	55	0.04	0.6	35	0.15	1.0
ECGT 080304E-SF3	H07	0.4	–	–	–	85	0.09	1.0	135	0.10	1.0	430	0.12	1.0	40	0.07	0.8	–	–	–
	T6310	0.4	160	0.10	1.0	115	0.09	1.0	125	0.10	1.0	480	0.12	1.0	45	0.07	0.8	30	0.15	1.0



ECMT

	IC (mm)	D1 (mm)	L (mm)	S (mm)
0602	6.350	2.80	6.50	2.38
0803	7.940	3.40	8.20	3.18

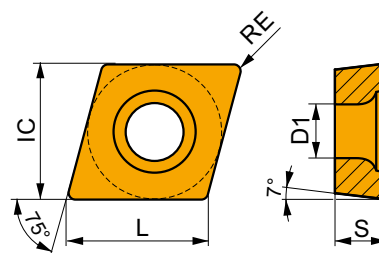

Idoneità e valori iniziali per velocità di taglio (Vc), avanzamento (f) e profondità di taglio (ap). Fare riferimento alla nostra App Machining Calculator per ulteriori calcoli.

Codice prodotto	RE (mm)	P			M			K			N			S			H		
		vc (m/min)	f (mm/rev)	ap (mm)	vc (m/min)	f (mm/rev)	ap (mm)	vc (m/min)	f (mm/rev)	ap (mm)	vc (m/min)	f (mm/rev)	ap (mm)	vc (m/min)	f (mm/rev)	ap (mm)	vc (m/min)	f (mm/rev)	ap (mm)

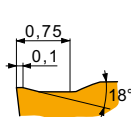
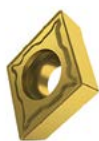

FM2 geometria per operazioni da finitura fino a lavorazioni medie, da taglio continuo a interrotto.

ECMT 060204E-FM2	T7325	0.4	✓	180	0.12	0.8	✓	140	0.11	0.8	–	–	–	–	–	–	–	–	–
	T8330	0.4	■	155	0.12	0.8	✓	90	0.11	0.8	■	145	0.12	0.8	–	–	–	–	–
	T8430	0.4	■	205	0.12	0.8	✓	110	0.11	0.8	✓	170	0.12	0.8	–	–	–	–	–
	T9315	0.4	■	290	0.12	0.8	–	–	–	–	✓	275	0.12	0.8	–	–	–	–	–
	T9325	0.4	■	255	0.12	0.8	✓	150	0.11	0.8	✓	240	0.12	0.8	–	–	–	–	–
	T9335	0.4	■	220	0.12	0.8	✓	130	0.11	0.8	–	–	–	–	–	–	–	–	–
ECMT 080304E-FM2	T5315	0.4	✓	280	0.12	1.0	–	–	–	–	■	265	0.12	1.0	–	–	–	–	–
	T7325	0.4	✓	170	0.12	1.0	✓	130	0.11	1.0	–	–	–	–	–	–	–	–	
	T8330	0.4	■	150	0.12	1.0	✓	90	0.11	1.0	■	140	0.12	1.0	–	–	–	–	–
	T8430	0.4	■	205	0.12	1.0	✓	110	0.11	1.0	✓	170	0.12	1.0	–	–	–	–	–
	T9315	0.4	■	280	0.12	1.0	–	–	–	–	✓	265	0.12	1.0	–	–	–	–	–
	T9325	0.4	■	255	0.12	1.0	✓	150	0.11	1.0	✓	240	0.12	1.0	–	–	–	–	–
T9335	0.4	■	215	0.12	1.0	✓	125	0.11	1.0	–	–	–	–	–	–	–	–	–	
ECMT 080308E-FM2	T7325	0.8	✓	185	0.17	1.0	✓	140	0.15	1.0	–	–	–	–	–	–	–	–	
	T8330	0.8	■	165	0.17	1.0	✓	95	0.15	1.0	■	155	0.17	1.0	–	–	–	–	–
	T8430	0.8	■	210	0.17	1.0	✓	115	0.15	1.0	✓	175	0.17	1.0	–	–	–	–	–
	T9315	0.8	■	290	0.17	1.0	–	–	–	–	✓	275	0.17	1.0	–	–	–	–	–
	T9325	0.8	■	260	0.17	1.0	✓	155	0.15	1.0	✓	245	0.17	1.0	–	–	–	–	–
	T9335	0.8	■	225	0.17	1.0	✓	135	0.15	1.0	–	–	–	–	–	–	–	–	–



ECMW



	IC (mm)	D1 (mm)	L (mm)	S (mm)
0602	6.350	2.80	6.50	2.38
0803	7.940	3.40	8.20	3.18

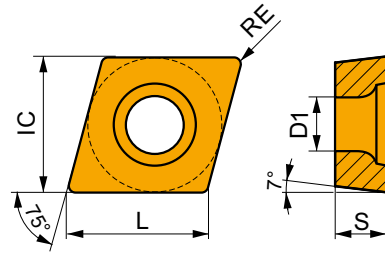

Idoneità e valori iniziali per velocità di taglio (Vc), avanzamento (f) e profondità di taglio (ap). Fare riferimento alla nostra App Machining Calculator per ulteriori calcoli.

Codice prodotto	RE (mm)	P			M			K			N			S			H		
		vc (m/min)	f (mm/rev)	ap (mm)	vc (m/min)	f (mm/rev)	ap (mm)	vc (m/min)	f (mm/rev)	ap (mm)	vc (m/min)	f (mm/rev)	ap (mm)	vc (m/min)	f (mm/rev)	ap (mm)	vc (m/min)	f (mm/rev)	ap (mm)

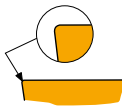
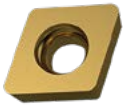

Adatta per operazioni da finitura fino a semi sgrossatura, da taglio continuo a leggermente interrotto.

ECMW 060204	H07	0.4	-	-	-	-	-	-	100	0.10	2.0	-	-	-	-	-	-	-
ECMW 080304	H07	0.4	-	-	-	-	-	-	100	0.10	2.5	-	-	-	-	-	-	-
ECMW 080308	H07	0.8	-	-	-	-	-	-	95	0.18	2.5	-	-	-	-	-	-	-



SEGC(RL) EXT



Utensile esterno, bloccaggio a vite, inserti EC... angolo del tagliente utensile 90°

Utensile di tornitura esterna destro/sinistro con bloccaggio a vite, angolo del tagliente utensile 90° per inserto positivo EC...08. Adatto per operazioni di sfacciatura, tornitura longitudinale con spallamento, conicità e smussi. Disponibile con stelo da 12x12 a 16x16 mm. Corpo trattato per una maggiore durata.

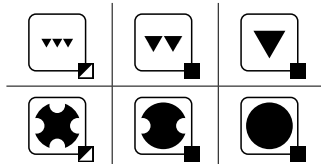
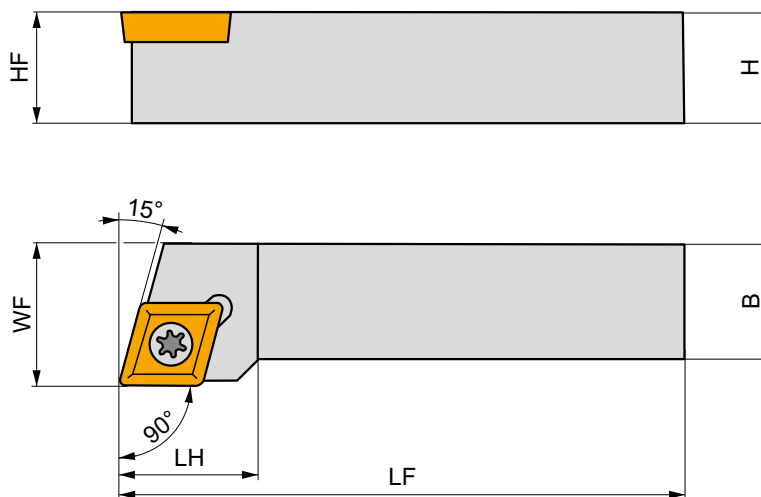
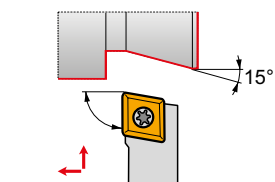

Codice prodotto		H	B	HF	WF	LF	LH	LAMS	GAMO	kg		
		(mm)	(mm)	(mm)	(mm)	(mm)	(mm)	(°)	(°)			
R	SEGCR 1212 N 08	12	12	12	16	160	12	0	0	0.15	GI210	SE08
	SEGCR 1616 H 08	16	16	16	20	100	12	0	0	0.22	GI210	SE08
L	SEGCL 1212 N 08	12	12	12	16	160	12	0	0	0.22	GI210	SE08
	SEGCL 1616 H 08	16	16	16	20	100	12	0	0	2.14	GI210	SE08



GI210



EC..0803..



SE08



416.1-832



3.6



M 3



8.5



PT-8002



SEUC(RL) INT

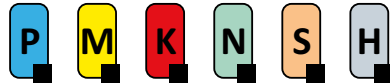

PRAMET

S



Utensile interno, bloccaggio a vite, inserti EC... angolo del tagliente utensile 93°

Bareno destro/sinistro per tornitura interna con bloccaggio a vite, angolo del tagliente utensile 93° per inserti positivi EC...06 e 08. Diametro interno minimo tornibile Ø11 mm. Adatto per operazioni di tornitura longitudinale, spallamento, conicità e smussi. Disponibile con stelo da Ø6 mm a Ø25 mm. Corpo trattato per una maggiore durata.

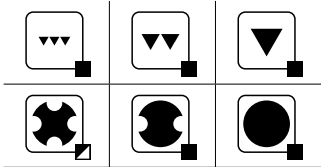
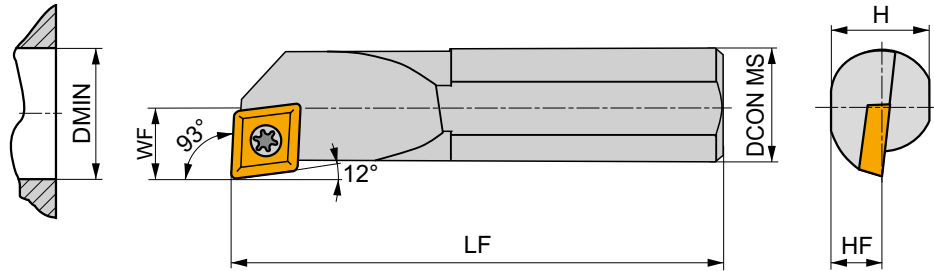
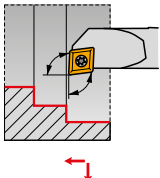

Codice prodotto	DCON MS (mm)	DMIN (mm)	WF (mm)	H (mm)	HF (mm)	LF (mm)	LAMS (°)	GAMO (°)	kg	GI	SE
R S08K-SEUCR 06	8	11	7	7	3.5	125	-5	0	0.06	GI213	SE23
S10M-SEUCR 06	10	13	8	9	4.5	150	-5	0	0.10	GI213	SE23
S12M-SEUCR 08	12	15	9	11	5.5	150	-5	0	0.14	GI210	SE24
S16R-SEUCR 08	16	20	11	15	7.5	200	-5	0	0.32	GI210	SE24
S20S-SEUCR 08	20	25	13	18	9	250	-5	0	0.58	GI210	SE24
S25T-SEUCR 08	25	32	17	23	11.5	300	-4	0	1.06	GI210	SE24
L S08K-SEUCL 06	8	11	7	7	3.5	125	-5	0	0.06	GI213	SE23
S10M-SEUCL 06	10	13	8	9	4.5	150	-5	0	0.10	GI213	SE23
S12M-SEUCL 08	12	15	9	11	5.5	150	-5	0	0.14	GI210	SE24
S16R-SEUCL 08	16	20	11	15	7.5	200	-5	0	0.32	GI210	SE24
S20S-SEUCL 08	20	25	13	18	9	250	-5	0	0.58	GI210	SE24

GI210	EC.. 0803..
GI213	EC.. 0602..

SE23	5513 020-03	0.8 Nm	M 2.5	6.5	PT-8001
SE24	416.1-832	3.6 Nm	M 3	8.5	PT-8003



EP

05

INSERTI IN METALLO DURO

EPGX



110

EPMT



110

ABBINAMENTO DELLA DIMENSIONE CORRETTA (esempio)

Inserto

EPGX 050202FR-JZ

Portainsero

S0608H-SELPR 05

TORNITURA ISO INTERNA

SELP(RL) INT

95°

EP..



05

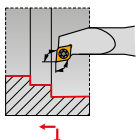

111

110

SELP(RL)-E INT

95°

EP..



05

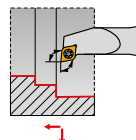

112

110

SEUP(RL) INT

93°

EP..



05

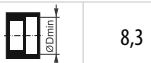
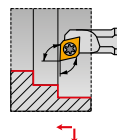

113

110

SEXP(RL) INT

52°30'

EP..



05

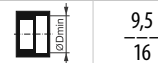
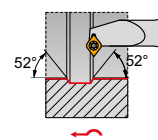

114

110

SEXP(RL)-E INT

52°30'

EP..



05

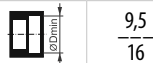
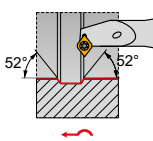

115

110



EPGX



	IC	D1	L	S
	(mm)	(mm)	(mm)	(mm)
0502	5.560	2.50	5.70	2.38

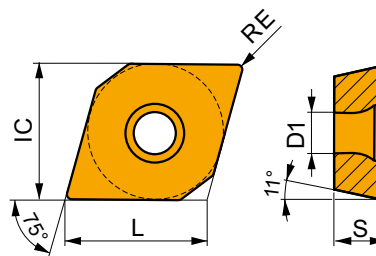

Idoneità e valori iniziali per velocità di taglio (Vc), avanzamento (f) e profondità di taglio (ap). Fare riferimento alla nostra App Machining Calculator per ulteriori calcoli.

Codice prodotto	RE	P			M			K			N			S			H		
		vc	f	ap	vc	f	ap	vc	f	ap	vc	f	ap	vc	f	ap	vc	f	ap
	(mm)	(m/min)	(mm/rev)	(mm)	(m/min)	(mm/rev)	(mm)	(m/min)	(mm/rev)	(mm)	(m/min)	(mm/rev)	(mm)	(m/min)	(mm/rev)	(mm)	(m/min)	(mm/rev)	(mm)

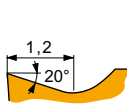

FR-JZ geometria destra positiva, adatta per operazioni di super finitura, taglio continuo.

EPGX 050202FR-JZ	TT010	0.2	295	0.06	0.5	175	0.05	0.5	-	-	-	-	-	-	-	-	-	-	-
------------------	-------	-----	-----	------	-----	-----	------	-----	---	---	---	---	---	---	---	---	---	---	---

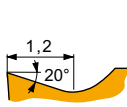

FL-JZ geometria positiva sinistra per operazioni di super finitura, taglio continuo.

EPGX 050202FL-JZ	TT010	0.2	295	0.06	0.5	175	0.05	0.5	-	-	-	-	-	-	-	-	-	-	-
------------------	-------	-----	-----	------	-----	-----	------	-----	---	---	---	---	---	---	---	---	---	---	---

EPMT



	IC	D1	L	S
	(mm)	(mm)	(mm)	(mm)
0502	5.560	2.50	5.70	2.38

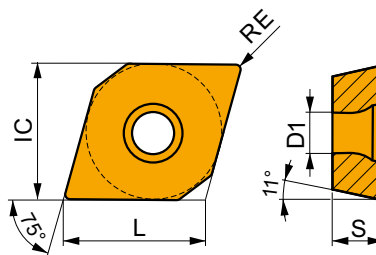

Idoneità e valori iniziali per velocità di taglio (Vc), avanzamento (f) e profondità di taglio (ap). Fare riferimento alla nostra App Machining Calculator per ulteriori calcoli.

Codice prodotto	RE	P			M			K			N			S			H		
		vc	f	ap	vc	f	ap	vc	f	ap	vc	f	ap	vc	f	ap	vc	f	ap
	(mm)	(m/min)	(mm/rev)	(mm)	(m/min)	(mm/rev)	(mm)	(m/min)	(mm/rev)	(mm)	(m/min)	(mm/rev)	(mm)	(m/min)	(mm/rev)	(mm)	(m/min)	(mm/rev)	(mm)



NF2 geometria con design positivo per operazioni da finitura e semi sgrassatura, taglio continuo.

EPMT 050202E-NF2	H07	0.2	-	-	-	80	0.09	0.8	125	0.10	0.8	405	0.12	0.8	40	0.07	0.6	-	-	-
	T7325	0.2	215	0.07	0.8	165	0.06	0.8	-	-	-	-	-	-	65	0.06	0.6	-	-	-
	T7335	0.2	220	0.07	0.8	170	0.06	0.8	-	-	-	-	-	-	70	0.06	0.6	-	-	-
	T9315	0.2	390	0.05	0.8	-	-	-	370	0.05	0.8	-	-	-	-	-	-	-	-	-
	T9325	0.2	305	0.07	0.8	180	0.06	0.8	285	0.07	0.8	-	-	-	65	0.06	0.6	-	-	-
	T9335	0.2	200	0.10	0.8	120	0.09	0.8	-	-	-	-	-	-	45	0.07	0.6	-	-	-
	TT010	0.2	345	0.05	0.5	205	0.05	0.5	-	-	-	-	-	-	-	-	-	-	-	-



SELP(RL) INT



PRAMET

S



Utensile interno, bloccaggio a vite, inserti EP... angolo del tagliente utensile 95°

Bareno destro/sinistro per tornitura interna con bloccaggio a vite e passaggio refrigerante interno, angolo del tagliente utensile 95° per inserto positivo EP...0502. Diametro interno minimo tornibile Ø8 mm. Adatto per operazioni di tornitura longitudinale, spallamento, conicità e smussi. Disponibile con stelo da Ø8 mm a Ø16 mm. Corpo trattato per una maggiore durata.

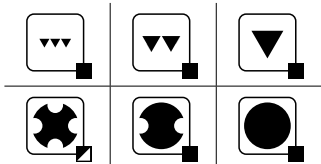
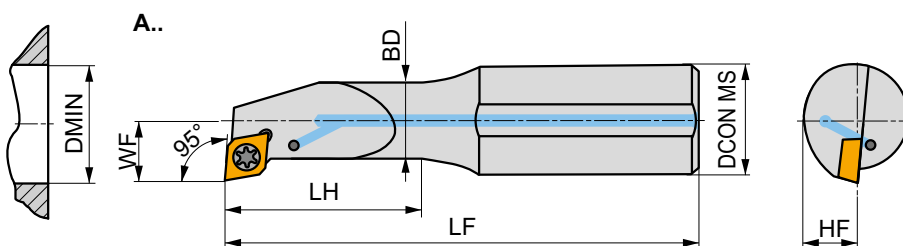
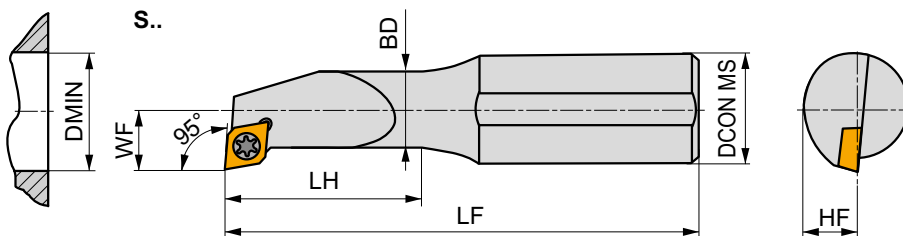
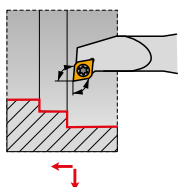

Codice prodotto	DCON MS	DMIN	BD	WF	LF	LH	LAMS	GAMO				
	(mm)	(mm)	(mm)	(mm)	(mm)	(mm)	(°)	(°)				
R S0608H-SELPR 05	8	8	6	4.5	100	20	-10	0	-	0.04	GI212	SE21
S0810J-SELPR 05	10	11	8	6	110	26	-5	0	-	0.06	GI212	SE22
S1012K-SELPR 05	12	13	10	7	125	32	-5	0	-	0.11	GI212	SE22
A1216M-SELPR 05	16	16	12	9	150	40	-2	0	✓	0.18	GI212	SE22
S1216M-SELPR 05	16	16	12	9	150	40	-2	0	-	0.21	GI212	SE22
L S0608H-SELPL 05	8	8	6	4.5	100	20	-10	0	-	0.04	GI212	SE21
S0810J-SELPL 05	10	11	8	6	110	26	-5	0	-	0.06	GI212	SE22
S1012K-SELPL 05	12	13	10	7	125	32	-5	0	-	0.11	GI212	SE22
S1216M-SELPL 05	16	16	12	9	150	40	-2	0	-	0.21	GI212	SE22

	GI212		EP. 0502..
--	-------	--	------------

	SE21		28992		0.8		M 2.2		4.2		MA2-8304
	SE22		28588		0.8		M 2.2		5.6		MA2-8304



SELP(RL)-E INT

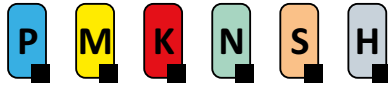

PRAMET

S



Utensile interno in metallo duro, bloccaggio a vite, per inserto EP... angolo del tagliente utensile 95°
 Bareno destro/sinistro in metallo duro per tornitura interna con bloccaggio a vite e passaggio refrigerante interno, angolo del tagliente utensile 95° per inserto positivo EP...0502. Diametro interno minimo tornibile Ø8 mm. Adatto per operazioni di tornitura longitudinale, spallamento, conicità e smussi. Disponibile con stelo da Ø8 mm a Ø16 mm. Per sporgenze utensile >3xD.

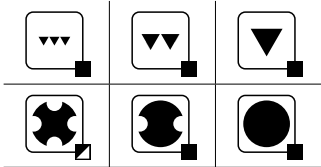
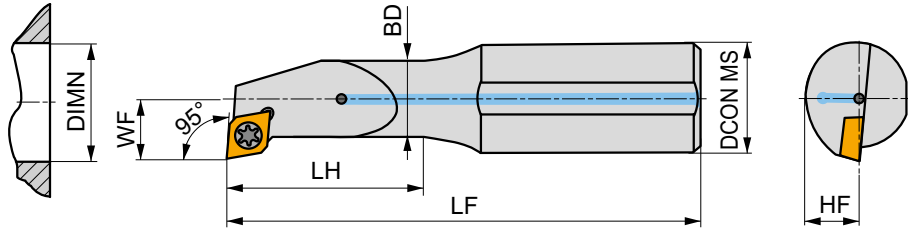
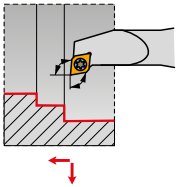

Codice prodotto	DCON MS (mm)	DMIN (mm)	BD (mm)	WF (mm)	LF (mm)	LH (mm)	LAMS (°)	GAMO (°)		kg		
R E0608H-SELPR 05	8	8	6	4.5	100	28	-10	0	✓	0.06	GI212	SE22
E0810J-SELPR 05	10	11	8	6	110	36	-5	0	✓	0.10	GI212	SE22
E1012K-SELPR 05	12	13	10	7	125	44	-5	0	✓	0.18	GI212	SE22
L E0608H-SELPL 05	8	8	6	4.5	100	28	-10	0	✓	0.06	GI212	SE22
E0810J-SELPL 05	10	11	8	6	110	36	-5	0	✓	0.10	GI212	SE22
E1216M-SELPL 05	16	16	12	9	150	55	-2	0	✓	0.33	GI212	SE22

GI212 EP. 0502..

SE22 28588 0.8 M 2.2 5.6 MA2-8304



SEUP(RL) INT



Utensile interno, bloccaggio a vite, inserti EP... angolo del tagliente utensile 93°

Bareno destro/sinistro per tornitura interna con bloccaggio a vite, angolo del tagliente utensile 93° per inserto positivo EP...0502. Diametro interno minimo tornibile Ø8.3 mm. Adatto per operazioni di tornitura longitudinale, spallamento, conicità e smussi. Disponibile con stelo Ø6 mm. Corpo trattato per una maggiore durata.

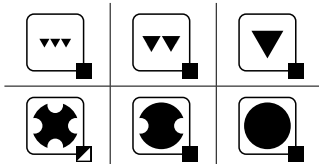
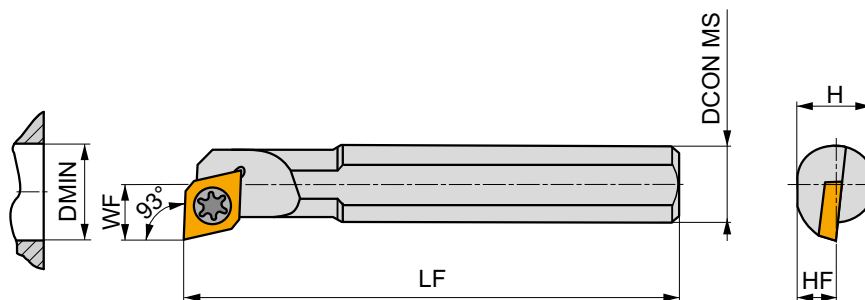
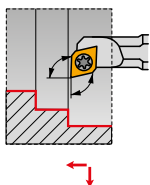

Codice prodotto	DCON MS (mm)	DMIN (mm)	WF (mm)	H (mm)	HF (mm)	LF (mm)	LAMS (°)	GAMO (°)	kg		
R S06H-SEUPR 05	6	8.3	5	5.4	2.7	100	-7	0	0.03	GI212	SE21
L S06H-SEUPL 05	6	8.3	5	5.4	2.7	100	-7	0	0.03	GI212	SE21



GI212



EP..0502..



SE21



28992



0.8



M 2.2



4.2



MA2-8304



SEXP(RL) INT

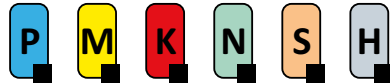

PRAMET

S



Utensile interno, bloccaggio a vite, inserti EP... angolo del tagliente utensile 52.5°

Bareno destro/sinistro per tornitura interna con bloccaggio a vite, angolo del tagliente utensile 52.5° per inserto positivo EP...0502. Diametro interno minimo tornibile Ø9.5 mm. Adatto per operazioni di retro smussi, tornitura multidirezionale e longitudinale, conicità e smussi. Disponibile con stelo da Ø8 mm a Ø16 mm. Corpo trattato per una maggiore durata.

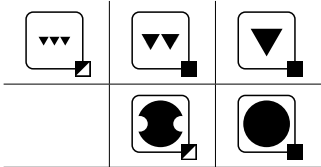
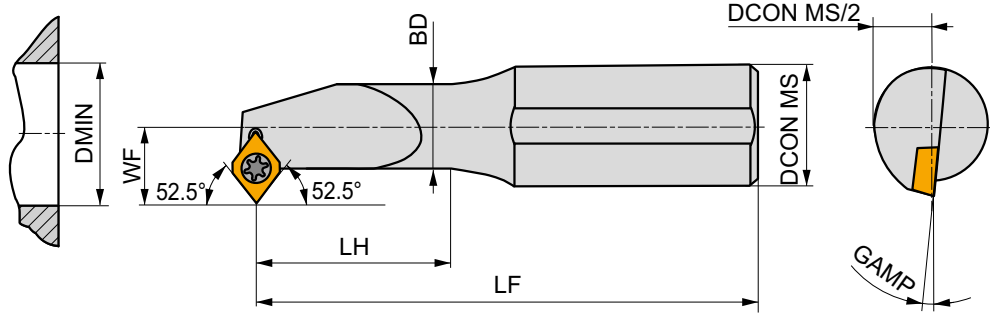
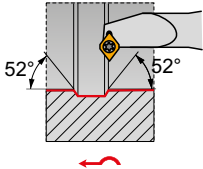

Codice prodotto	DCON MS (mm)	DMIN (mm)	BD (mm)	WF (mm)	LF (mm)	LH (mm)	GAMP (°)	kg	GI212	SE21/SE22
R S0608H-SEXPR 05	8	9.5	6	5.5	100	20	-7	0.04	GI212	SE21
S0810J-SEXPR 05	10	11	8	6	110	26	-5	0.06	GI212	SE22
S1012K-SEXPR 05	12	13	10	7	125	32	-5	0.11	GI212	SE22
S1216M-SEXPR 05	16	16	12	9	150	40	-2	0.21	GI212	SE22
L S0608H-SEXPL 05	8	9.5	6	5.5	100	20	-7	0.04	GI212	SE21
S0810J-SEXPL 05	10	11	8	6	110	26	-5	0.07	GI212	SE22
S1012K-SEXPL 05	12	13	10	7	125	32	-5	0.11	GI212	SE22
S1216M-SEXPL 05	16	16	12	9	150	40	-2	0.21	GI212	SE22

GI212	EP.. 0502..
-------	-------------

SE21	28992	0.8 Nm	M 2.2	4.2	MA2-8304
SE22	28588	0.8 Nm	M 2.2	5.6	MA2-8304



SEXP(RL)-E INT



PRAMET

S



Utensile interno in metallo duro, bloccaggio a vite, per inserto EP... angolo del tagliente utensile 52.5°

Bareno destro/sinistro in metallo duro per tornitura interna con bloccaggio a vite e passaggio refrigerante interno, angolo del tagliente utensile 52.5° per inserto positivo EP...0502. Diametro interno minimo tornibile Ø9.5 mm. Adatto per operazioni di retro smussi, tornitura multidirezionale e longitudinale, conicità e smussi. Disponibile con stelo da Ø8 mm a Ø16 mm. Per sporgenze utensile >3xD.

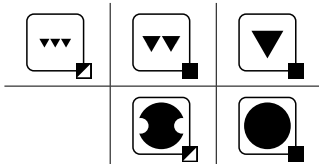
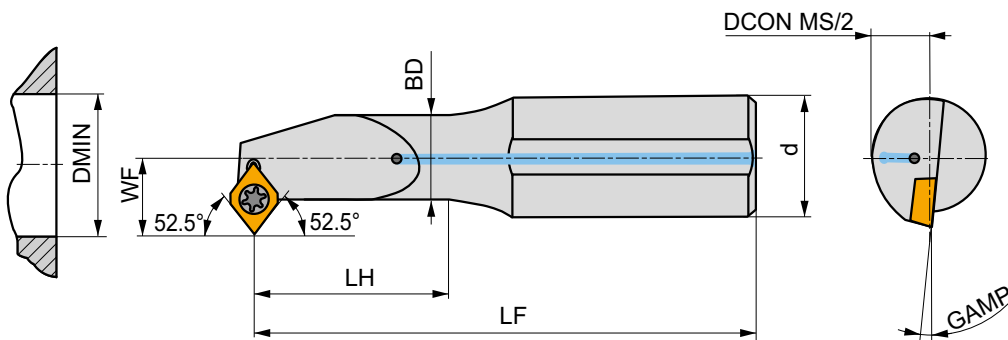
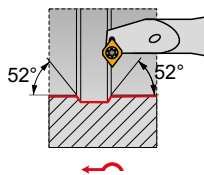

Codice prodotto	DCON MS	DMIN	BD	WF	LF	LH	GAMP		kg		
	(mm)	(mm)	(mm)	(mm)	(mm)	(mm)	(°)				
R E0608H-SEXPR 05	8	9.5	6	5.5	100	28	-7	✓	0.07	GI212	SE21
E0810J-SEXPR 05	10	11	8	6	110	36	-5	✓	0.11	GI212	SE22
E1012K-SEXPR 05	12	13	10	7	125	44	-5	✓	0.16	GI212	SE22
E1216M-SEXPR 05	16	16	12	9	150	55	-2	✓	0.32	GI212	SE22
L E0608H-SEXPL 05	8	9.5	6	5.5	100	28	-7	✓	0.06	GI212	SE21



GI212



EP..0502..



SE21
SE22



28992
28588



0.8
0.8



M 2.2
M 2.2



4.2
5.6



MA2-8304
MA2-8304



RC

06/ 08/ 12/ 16/ 20/ 25/ 32

INSERTI IN METALLO DURO

RCGT	RCMT	RCMW	RCMX
118	118	120	121

INSERTI CER

RCGX CER
123

ABBINAMENTO DELLA DIMENSIONE CORRETTA (esempio)

Inserto	Portainsero
RCMT 1204MOE-RM3	SRDCN 3225 P 12-M

TORNITURA ISO - ESTERNA

PRDCN EXT		PRSC(RL) EXT		SRDC(RL) EXT		SRDCN EXT	
	RC.. 20 25 32		RC.. 16 25		RC.. 08		RC.. 06 08 10 12 16
40x40 50x50	124	40x40	125	20x20 32x25	126	12x12 32x25	127
	118 - 123		118 - 123		118 - 123		118 - 123
SRSC(RL) EXT		C.-SRDCN EXT NEW					
	RC.. 06 08 10 12 16		RC.. 10 12				
12x12 32x25	128	C4 C5	130				
	118 - 123		118 - 123				







RC

06/ 08/ 12/ 16/ 20/ 25/ 32

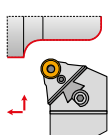
TORNITURA ISO - SGROSSATURA PESANTE - ESTERNA

KHP-RSCR/L + DKH(RL)

 <p>DKHR+KHP-RSCR</p>	RC..
	 <p>20 25 32</p>
	<p>40×50 60×80</p>
 <p>131, 132</p>	 <p>118 – 123</p>



RCGT



	INSD (mm)	D1 (mm)	S (mm)
0803	8.0	3.40	3.18
1003	10.0	4.40	3.18

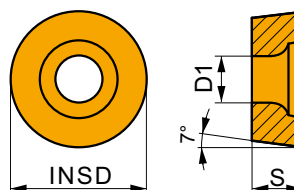

Idoneità e valori iniziali per velocità di taglio (Vc), avanzamento (f) e profondità di taglio (ap). Fare riferimento alla nostra App Machining Calculator per ulteriori calcoli.

Codice prodotto	RE (mm)	P			M			K			N			S			H		
		vc (m/min)	f (mm/rev)	ap (mm)	vc (m/min)	f (mm/rev)	ap (mm)	vc (m/min)	f (mm/rev)	ap (mm)	vc (m/min)	f (mm/rev)	ap (mm)	vc (m/min)	f (mm/rev)	ap (mm)	vc (m/min)	f (mm/rev)	ap (mm)

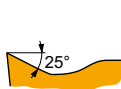

AL geometria con design altamente positivo per operazioni da finitura fino a sgrossatura, da taglio continuo a leggermente interrotto.

RCGT 0803MOF-AL	HF7	-	-	-	-	-	-	-	-	285	1.20	1.0	-	-	-	-	-	-
	T0315	-	-	-	-	-	-	-	-	420	1.20	1.0	-	-	-	-	-	-
RCGT 1003MOF-AL	HF7	-	-	-	-	-	-	-	-	255	1.50	1.0	-	-	-	-	-	-
	T0315	-	-	-	-	-	-	-	-	390	1.50	1.0	-	-	-	-	-	-

RCMT



	INSD (mm)	D1 (mm)	S (mm)
0602	6.0	2.80	2.38
0803	8.0	3.40	3.18
10T3	10.0	4.40	3.97
1204	12.0	4.40	4.76
1606	16.0	5.50	6.35
2006	20.0	6.50	6.35
2507	25.0	8.60	7.94

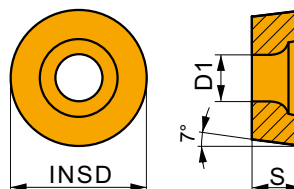

Idoneità e valori iniziali per velocità di taglio (Vc), avanzamento (f) e profondità di taglio (ap). Fare riferimento alla nostra App Machining Calculator per ulteriori calcoli.

Codice prodotto	RE (mm)	P			M			K			N			S			H		
		vc (m/min)	f (mm/rev)	ap (mm)	vc (m/min)	f (mm/rev)	ap (mm)	vc (m/min)	f (mm/rev)	ap (mm)	vc (m/min)	f (mm/rev)	ap (mm)	vc (m/min)	f (mm/rev)	ap (mm)	vc (m/min)	f (mm/rev)	ap (mm)

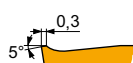

37 geometria per operazioni da semi sgrossatura fino a sgrossatura pesante, da taglio continuo a interrotto.

RCMT 1606MOS-37	T9315	-	165	0.60	3.0	-	-	-	155	0.60	3.0	-	-	-	-	-	-	-
	T9325	-	145	0.60	3.0	-	-	-	135	0.60	3.0	-	-	-	-	-	-	-

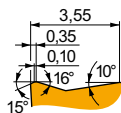

371 geometria per operazioni da semi sgrossatura fino a sgrossatura pesante, da taglio continuo a interrotto.

RCMT 2006MOS-371	T9315	-	145	0.80	3.0	-	-	-	135	0.80	3.0	-	-	-	-	-	-	-
	T9325	-	125	0.80	3.0	-	-	-	115	0.80	3.0	-	-	-	-	-	-	-



Idoneità e valori iniziali per velocità di taglio (Vc), avanzamento (f) e profondità di taglio (ap). Fare riferimento alla nostra App Machining Calculator per ulteriori calcoli.

Codice prodotto	RE  (mm)	P			M			K			N			S			H		
		vc (m/min)	f (mm/rev)	ap (mm)	vc (m/min)	f (mm/rev)	ap (mm)	vc (m/min)	f (mm/rev)	ap (mm)	vc (m/min)	f (mm/rev)	ap (mm)	vc (m/min)	f (mm/rev)	ap (mm)	vc (m/min)	f (mm/rev)	ap (mm)

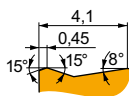

372 geometria per operazioni da semi sgrassatura fino a sgrassatura pesante, da taglio continuo a interrotto.

RCMT 2507M05-372	T9325	-	90	0.80	3.0	-	-	-	85	0.80	3.0	-	-	-	-	-	-	-
------------------	-------	---	----	------	-----	---	---	---	----	------	-----	---	---	---	---	---	---	---

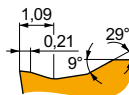

FM geometria per operazioni da finitura fino a semi sgrassatura, da taglio continuo a leggermente interrotto.

RCMT 0602M0E-FM	T7325	-	215	0.45	1.2	165	0.41	1.2	-	-	-	-	-	-	-	-	-	-
	T8330	-	190	0.45	1.2	110	0.41	1.2	180	0.45	1.2	570	0.54	1.2	-	-	-	-
	T8430	-	200	0.45	1.2	110	0.41	1.2	165	0.45	1.2	555	0.54	1.2	-	-	-	-
	T9315	-	260	0.45	1.2	-	-	-	245	0.45	1.2	-	-	-	-	-	-	-
	T9325	-	235	0.45	1.2	140	0.41	1.2	220	0.45	1.2	-	-	-	-	-	-	-
RCMT 0803M0E-FM	T7325	-	190	0.60	1.6	145	0.54	1.6	-	-	-	-	-	-	-	-	-	-
	T8330	-	170	0.60	1.6	100	0.54	1.6	160	0.60	1.6	510	0.72	1.6	-	-	-	-
	T8430	-	175	0.60	1.6	95	0.54	1.6	140	0.60	1.6	480	0.72	1.6	-	-	-	-
	T9315	-	225	0.60	1.6	-	-	-	210	0.60	1.6	-	-	-	-	-	-	-
	T9325	-	200	0.60	1.6	120	0.54	1.6	190	0.60	1.6	-	-	-	-	-	-	-
RCMT 10T3M0E-FM	T7325	-	185	0.65	1.7	140	0.59	1.7	-	-	-	-	-	-	-	-	-	-
	T8330	-	165	0.65	1.7	95	0.59	1.7	155	0.65	1.7	495	0.78	1.7	-	-	-	-
	T8430	-	170	0.65	1.7	90	0.59	1.7	135	0.65	1.7	465	0.78	1.7	-	-	-	-
	T9315	-	220	0.65	1.7	-	-	-	205	0.65	1.7	-	-	-	-	-	-	-
	T9325	-	195	0.65	1.7	115	0.59	1.7	185	0.65	1.7	-	-	-	-	-	-	-
RCMT 1204M0E-FM	T7325	-	175	0.70	1.8	135	0.63	1.8	-	-	-	-	-	-	-	-	-	-
	T8330	-	160	0.70	1.8	95	0.63	1.8	150	0.70	1.8	480	0.84	1.8	-	-	-	-
	T8430	-	155	0.70	1.8	85	0.63	1.8	130	0.70	1.8	435	0.84	1.8	-	-	-	-
	T9315	-	205	0.70	1.8	-	-	-	190	0.70	1.8	-	-	-	-	-	-	-
	T9325	-	190	0.70	1.8	110	0.63	1.8	180	0.70	1.8	-	-	-	-	-	-	-

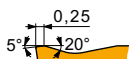

RM3 geometria per operazioni da semi sgrassatura fino a sgrassatura, da taglio continuo a interrotto.

RCMT 0803M0E-RM3	T7325	-	185	0.50	1.3	140	0.45	1.3	-	-	-	-	-	-	-	-	-
	T9315	-	225	0.50	1.3	-	-	-	210	0.50	1.3	-	-	-	45	0.15	1.0
RCMT 1204M0E-RM3	H07	-	-	-	-	65	0.54	1.8	105	0.60	1.8	-	-	-	-	-	-
	T7325	-	165	0.60	1.8	125	0.54	1.8	-	-	-	-	-	-	-	-	-
	T8330	-	150	0.60	1.8	90	0.54	1.8	140	0.60	1.8	-	-	-	30	0.15	1.0
	T8430	-	150	0.60	1.8	80	0.54	1.8	125	0.60	1.8	-	-	-	25	0.15	1.0
	T9315	-	205	0.60	1.8	-	-	-	190	0.60	1.8	-	-	-	40	0.15	1.0
RCMT 1606M0E-RM3	T7325	-	160	0.65	2.0	120	0.59	2.0	-	-	-	-	-	-	-	-	-
	T8330	-	145	0.65	2.0	85	0.59	2.0	135	0.65	2.0	-	-	-	25	0.15	1.0
	T8430	-	145	0.65	2.0	80	0.59	2.0	120	0.65	2.0	-	-	-	25	0.15	1.0
	T9315	-	195	0.65	2.0	-	-	-	185	0.65	2.0	-	-	-	35	0.15	1.0
RCMT 2507M0E-RM3	H07	-	-	-	-	60	0.54	3.0	95	0.60	3.0	-	-	-	-	-	-

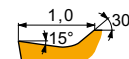

UR geometria per lavorazioni leggere e finitura, da taglio continuo a leggermente interrotto.

RCMT 0602M0E-UR	T6310	-	170	0.40	1.2	120	0.36	1.2	135	0.40	1.2	-	-	-	-	-	-
	T7325	-	190	0.40	1.2	145	0.36	1.2	-	-	-	-	-	-	-	-	-
	T8330	-	170	0.40	1.2	100	0.36	1.2	160	0.40	1.2	-	-	-	-	-	-
	T8430	-	180	0.40	1.2	95	0.36	1.2	145	0.40	1.2	-	-	-	-	-	-
	T9315	-	240	0.40	1.2	-	-	-	225	0.40	1.2	-	-	-	-	-	-
	T9325	-	215	0.40	1.2	125	0.36	1.2	200	0.40	1.2	-	-	-	-	-	-



Idoneità e valori iniziali per velocità di taglio (Vc), avanzamento (f) e profondità di taglio (ap). Fare riferimento alla nostra App Machining Calculator per ulteriori calcoli.

Codice prodotto	RE (mm)	P			M			K			N			S			H		
		vc (m/min)	f (mm/rev)	ap (mm)	vc (m/min)	f (mm/rev)	ap (mm)	vc (m/min)	f (mm/rev)	ap (mm)	vc (m/min)	f (mm/rev)	ap (mm)	vc (m/min)	f (mm/rev)	ap (mm)	vc (m/min)	f (mm/rev)	ap (mm)

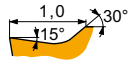

UR geometria per lavorazioni leggere e finitura, da taglio continuo a leggermente interrotto.

RCMT 0803MOE-UR	T6310	—	■	160	0.45	1.6	☑	115	0.41	1.6	■	125	0.45	1.6	—	—	—	—	—	—
	T7325	—	☑	180	0.45	1.6	☑	140	0.41	1.6	—	—	—	—	—	—	—	—	—	—
	T8330	—	■	160	0.45	1.6	☑	95	0.41	1.6	■	150	0.45	1.6	—	—	—	—	—	—
	T8430	—	■	170	0.45	1.6	☑	90	0.41	1.6	☑	135	0.45	1.6	—	—	—	—	—	—
	T9315	—	■	220	0.45	1.6	—	—	—	—	☑	205	0.45	1.6	—	—	—	—	—	—
RCMT 10T3MOE-UR	T6310	—	■	160	0.50	1.4	☑	115	0.45	1.4	■	125	0.50	1.4	—	—	—	—	—	—
	T7325	—	☑	175	0.50	1.4	☑	135	0.45	1.4	—	—	—	—	—	—	—	—	—	—
	T8330	—	■	160	0.50	1.4	☑	95	0.45	1.4	■	150	0.50	1.4	—	—	—	—	—	—
	T8430	—	■	165	0.50	1.4	☑	90	0.45	1.4	☑	135	0.50	1.4	—	—	—	—	—	—
	T9315	—	■	215	0.50	1.4	—	—	—	—	☑	200	0.50	1.4	—	—	—	—	—	—
RCMT 1204MOE-UR	T6310	—	■	150	0.55	1.8	☑	105	0.50	1.8	■	120	0.55	1.8	—	—	—	—	—	—
	T7325	—	☑	165	0.55	1.8	☑	125	0.50	1.8	—	—	—	—	—	—	—	—	—	—
	T8330	—	■	150	0.55	1.8	☑	90	0.50	1.8	■	140	0.55	1.8	—	—	—	—	—	—
	T8430	—	■	145	0.55	1.8	☑	80	0.50	1.8	☑	120	0.55	1.8	—	—	—	—	—	—
	T9315	—	■	200	0.55	1.8	—	—	—	—	☑	190	0.55	1.8	—	—	—	—	—	—
T9325	—	■	180	0.55	1.8	☑	105	0.50	1.8	☑	170	0.55	1.8	—	—	—	—	—	—	

RCMW



	INSD (mm)	D1 (mm)	S (mm)
0602	6.0	2.80	2.38
0803	8.0	3.40	3.18
10T3	10.0	4.40	3.97
1204	12.0	4.40	4.76

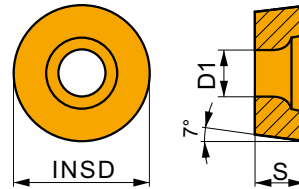

Idoneità e valori iniziali per velocità di taglio (Vc), avanzamento (f) e profondità di taglio (ap). Fare riferimento alla nostra App Machining Calculator per ulteriori calcoli.

Codice prodotto	RE (mm)	P			M			K			N			S			H		
		vc (m/min)	f (mm/rev)	ap (mm)	vc (m/min)	f (mm/rev)	ap (mm)	vc (m/min)	f (mm/rev)	ap (mm)	vc (m/min)	f (mm/rev)	ap (mm)	vc (m/min)	f (mm/rev)	ap (mm)	vc (m/min)	f (mm/rev)	ap (mm)

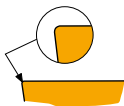

Adatta per operazioni da finitura fino a semi sgrossatura, da taglio continuo a leggermente interrotto.

RCMW 0602MO	T5305	—	—	—	—	—	—	■	280	0.25	0.6	—	—	—	—	—	—	☑	55	0.15	1.0
	T5315	—	—	—	—	—	—	■	250	0.25	0.6	—	—	—	—	—	—	☑	50	0.15	1.0
RCMW 0803MO	T5305	—	—	—	—	—	—	■	255	0.30	0.8	—	—	—	—	—	—	☑	50	0.15	1.0
	T5315	—	—	—	—	—	—	■	230	0.30	0.8	—	—	—	—	—	—	☑	45	0.15	1.0
RCMW 10T3MO	T5305	—	—	—	—	—	—	■	225	0.40	1.0	—	—	—	—	—	—	☑	45	0.15	1.0
	T5315	—	—	—	—	—	—	■	200	0.40	1.0	—	—	—	—	—	—	☑	40	0.15	1.0
RCMW 1204MO	T5305	—	—	—	—	—	—	■	205	0.45	1.2	—	—	—	—	—	—	☑	40	0.15	1.0
	T5315	—	—	—	—	—	—	■	190	0.45	1.2	—	—	—	—	—	—	☑	40	0.15	1.0



RCMX

	INSD (mm)	D1 (mm)	S (mm)
1003	10.0	3.60	3.18
1204	12.0	4.20	4.76
1606	16.0	5.20	6.35
2006	20.0	6.50	6.35
2507	25.0	7.20	7.94
3209	32.0	9.50	9.53

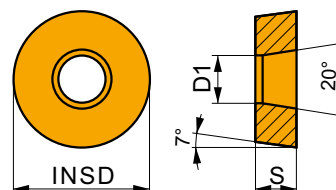

Idoneità e valori iniziali per velocità di taglio (Vc), avanzamento (f) e profondità di taglio (ap). Fare riferimento alla nostra App Machining Calculator per ulteriori calcoli.

Codice prodotto	RE (mm)	P			M			K			N			S			H		
		vc (m/min)	f (mm/rev)	ap (mm)	vc (m/min)	f (mm/rev)	ap (mm)	vc (m/min)	f (mm/rev)	ap (mm)	vc (m/min)	f (mm/rev)	ap (mm)	vc (m/min)	f (mm/rev)	ap (mm)	vc (m/min)	f (mm/rev)	ap (mm)

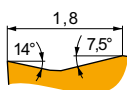

31 geometria per operazioni da finitura fino a semi sgrossatura, da taglio continuo a interrotto.

RCMX 1003M05-31

T9325	-	165	0.50	2.0	95	0.45	2.0	155	0.50	2.0	-	-	-	-	-	-	-	-
T9335	-	140	0.50	2.0	80	0.45	2.0	-	-	-	-	-	-	-	-	-	-	-

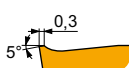

37 geometria per operazioni da semi sgrossatura fino a sgrossatura pesante, da taglio continuo a interrotto.

RCMX 1606M05-37

T9315	-	165	0.60	3.0	-	-	-	155	0.60	3.0	-	-	-	-	-	-	-	-
T9325	-	145	0.60	3.0	-	-	-	135	0.60	3.0	-	-	-	-	-	-	-	-

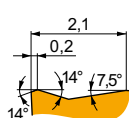

321 geometria per operazioni da semi sgrossatura fino a sgrossatura pesante, da taglio continuo a interrotto.

RCMX 1204M05-321

T9315	-	130	1.00	3.0	-	-	-	120	1.00	3.0	-	-	-	-	-	-	-	-
T9325	-	120	1.00	3.0	-	-	-	110	1.00	3.0	-	-	-	-	-	-	-	-
T9335	-	105	1.00	3.0	-	-	-	-	-	-	-	-	-	-	-	-	-	-

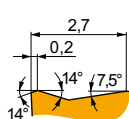

331 geometria per operazioni da semi sgrossatura fino a sgrossatura pesante, da taglio continuo a interrotto.

RCMX 1606M05-331

T9315	-	120	1.20	3.5	-	-	-	110	1.20	3.5	-	-	-	-	-	-	-	-
T9325	-	105	1.20	3.5	-	-	-	95	1.20	3.5	-	-	-	-	-	-	-	-
T9335	-	110	0.80	3.5	-	-	-	-	-	-	-	-	-	-	-	-	-	-

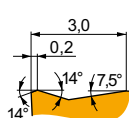

341 geometria per operazioni da semi sgrossatura fino a sgrossatura pesante, da taglio continuo a interrotto.

RCMX 2006M05-341

6640	-	90	1.00	3.5	-	-	-	85	1.00	3.5	-	-	-	-	-	-	-	-
------	---	----	------	-----	---	---	---	----	------	-----	---	---	---	---	---	---	---	---

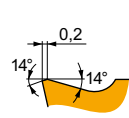

351 geometria per operazioni da semi sgrossatura fino a sgrossatura pesante, da taglio continuo a interrotto.

RCMX 2507M05-351

6640	-	60	1.00	3.5	-	-	-	55	1.00	3.5	-	-	-	-	-	-	-	-
------	---	----	------	-----	---	---	---	----	------	-----	---	---	---	---	---	---	---	---



Idoneità e valori iniziali per velocità di taglio (Vc), avanzamento (f) e profondità di taglio (ap). Fare riferimento alla nostra App Machining Calculator per ulteriori calcoli.

Codice prodotto	RE  (mm)	P			M			K			N			S			H		
		vc (m/min)	f (mm/rev)	ap (mm)	vc (m/min)	f (mm/rev)	ap (mm)	vc (m/min)	f (mm/rev)	ap (mm)	vc (m/min)	f (mm/rev)	ap (mm)	vc (m/min)	f (mm/rev)	ap (mm)	vc (m/min)	f (mm/rev)	ap (mm)

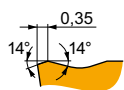

361 geometria per operazioni da sgrossatura fino a sgrossatura pesante, da taglio continuo a fortemente interrotto.

RCMX 3209MOS-361	6640	-	50	1.40	4.5	-	-	-	45	1.40	4.5	-	-	-	-	-	-	-	-
-------------------------	-------------	---	----	------	-----	---	---	---	----	------	-----	---	---	---	---	---	---	---	---

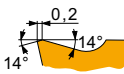

RF1 geometria per operazioni da finitura fino a semi sgrossatura, da taglio continuo a interrotto.

RCMX 2006MO-RF1	T5305	-	105	0.80	3.5	-	-	-	95	0.80	3.5	-	-	-	-	-	-	-	-
	T9310	-	105	0.80	3.5	-	-	-	95	0.80	3.5	-	-	-	-	-	-	-	-
	T9315	-	100	0.80	3.5	-	-	-	95	0.80	3.5	-	-	-	-	-	-	-	-
	T9325	-	90	0.80	3.5	-	-	-	85	0.80	3.5	-	-	-	-	-	-	-	-
	T9335	-	110	0.80	3.5	-	-	-	-	-	-	-	-	-	-	-	-	-	-
RCMX 2507MO-RF1	T8345	-	45	1.00	3.5	-	-	-	40	1.00	3.5	-	-	-	-	-	-	-	-
	T9310	-	95	1.00	3.5	-	-	-	90	1.00	3.5	-	-	-	-	-	-	-	-
	T9315	-	90	1.00	3.5	-	-	-	85	1.00	3.5	-	-	-	-	-	-	-	-
	T9325	-	80	1.00	3.5	-	-	-	75	1.00	3.5	-	-	-	-	-	-	-	-
	T9335	-	65	1.00	3.5	-	-	-	-	-	-	-	-	-	-	-	-	-	-

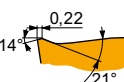

RM1 geometria per operazioni da finitura fino a sgrossatura, da taglio continuo a interrotto.

RCMX 2006MO-RM1	T9310	-	95	1.00	3.5	-	-	-	90	1.00	3.5	-	-	-	-	-	-	-	-
	T9315	-	90	1.00	3.5	-	-	-	85	1.00	3.5	-	-	-	-	-	-	-	-
	T9325	-	80	1.00	3.5	-	-	-	75	1.00	3.5	-	-	-	-	-	-	-	-
	T9335	-	125	0.60	3.0	-	-	-	-	-	-	-	-	-	-	-	-	-	-
RCMX 2507MO-RM1	T9310	-	95	1.00	3.5	-	-	-	90	1.00	3.5	-	-	-	-	-	-	-	-
	T9315	-	90	1.00	3.5	-	-	-	85	1.00	3.5	-	-	-	-	-	-	-	-
	T9325	-	80	1.00	3.5	-	-	-	75	1.00	3.5	-	-	-	-	-	-	-	-
	T9335	-	80	0.60	3.0	-	-	-	-	-	-	-	-	-	-	-	-	-	-

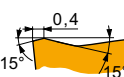

RM2 geometria per operazioni da semi sgrossatura fino a sgrossatura, da taglio continuo a interrotto.

RCMX 2507MO-RM2	T9310	-	90	1.10	3.5	-	-	-	85	1.10	3.5	-	-	-	-	-	-	-	-
	T9315	-	85	1.10	3.5	-	-	-	80	1.10	3.5	-	-	-	-	-	-	-	-
	T9325	-	75	1.10	3.5	-	-	-	70	1.10	3.5	-	-	-	-	-	-	-	-
RCMX 3209MO-RM2	T5315	-	95	1.00	4.5	-	-	-	90	1.00	4.5	-	-	-	-	-	-	-	-
	T9310	-	90	1.00	4.5	-	-	-	85	1.00	4.5	-	-	-	-	-	-	-	-
	T9315	-	85	1.00	4.5	-	-	-	80	1.00	4.5	-	-	-	-	-	-	-	-
	T9325	-	75	1.00	4.5	-	-	-	70	1.00	4.5	-	-	-	-	-	-	-	-
	T9335	-	55	1.40	4.5	-	-	-	-	-	-	-	-	-	-	-	-	-	-

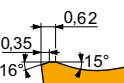

RR2 geometria per operazioni di sgrossatura pesante, da taglio continuo a interrotto.

RCMX 3209MO-RR2	T9315	-	60	1.40	4.5	-	-	-	55	1.40	4.5	-	-	-	-	-	-	10	0.15	1.0
	T9316	-	60	1.40	4.5	-	-	-	55	1.40	4.5	-	-	-	-	-	-	-	-	-



RCGX CER

	INSD	S
	(mm)	(mm)
0606	6.350	6.35
0907	9.525	7.94
1207	12.700	7.94

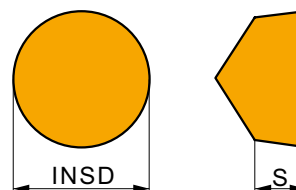

Idoneità e valori iniziali per velocità di taglio (Vc), avanzamento (f) e profondità di taglio (ap). Fare riferimento alla nostra App Machining Calculator per ulteriori calcoli.

Codice prodotto	RE (mm)	P			M			K			N			S			H		
		vc (m/min)	f (mm/rev)	ap (mm)	vc (m/min)	f (mm/rev)	ap (mm)	vc (m/min)	f (mm/rev)	ap (mm)	vc (m/min)	f (mm/rev)	ap (mm)	vc (m/min)	f (mm/rev)	ap (mm)	vc (m/min)	f (mm/rev)	ap (mm)

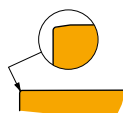

Adatta per lavorazioni con elevata velocità e taglio continuo.

RCGX 060600 K15015	TC100	-	-	-	-	-	-	365	0.30	0.8	-	-	-	-	-	-	-	-
RCGX 090700 K15015	TC100	-	-	-	-	-	-	410	0.20	1.2	-	-	-	-	-	-	-	-
RCGX 120700 K15015	TC100	-	-	-	-	-	-	405	0.20	1.5	-	-	-	-	-	-	-	-



PRDCN EXT

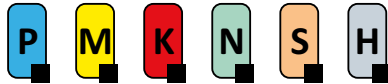

PRAMET



Utensile esterno, bloccaggio a leva per inserti tondi RC..

Utensile esterno di tornitura, neutro, con bloccaggio a leva per inserti positivi RC .. da 16 a 32. Adatto per sfacciatura e tornitura longitudinale senza spallamento, tornitura a copiare fino a 90°, tornitura conica e smussi. Disponibile con dimensioni stelo da 32x25 a 50x50 mm. Corpo trattato per una maggiore durata dell'utensile.

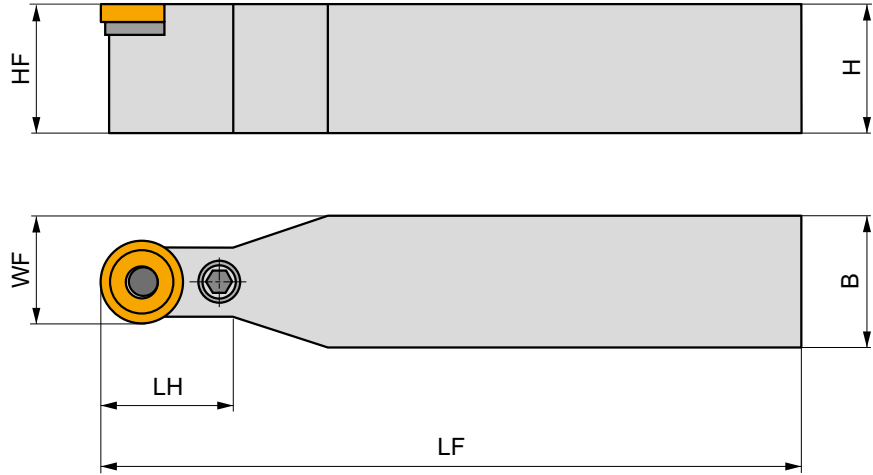
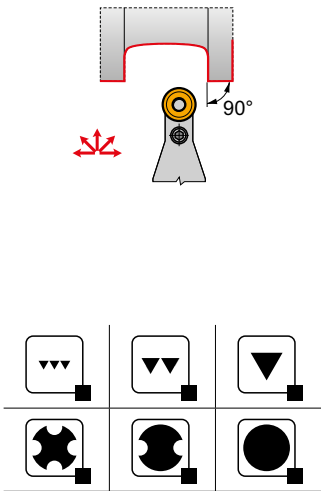

Codice prodotto	H	B	HF	WF	LF	LH	LAMS	GAMO	kg		
	(mm)	(mm)	(mm)	(mm)	(mm)	(mm)	(°)	(°)			
N PRDCN 3225 P 16	32	25	32	20.5	170	32	0	0	0.80	GI090	PRP70
PRDCN 3232 P 20	32	32	32	26	170	32	0	0	1.30	GI069	PRP90
PRDCN 4040 S 20	40	40	40	30	250	40	0	0	3.10	GI069	PRP90
PRDCN 4040 S 25	40	40	40	32.5	250	40	0	0	3.20	GI122	PRP80
PRDCN 5050 S 32	50	50	50	41	250	50	0	0	3.50	GI096	PRP32
PRDCN 5050 T 32	50	50	50	41	300	50	0	0	5.12	GI096	PRP32

GI069	RCMX 2006MO
GI090	RCMX 1606MO
GI096	RCMX 3209MO
GI122	RCMX 2507MO

PRP32	RCU 320600	PU 10	US 47	8.0	M 12x1	36	NT 08	MT 08	HXX 5
PRP70	RCU 160300	PU 07	US 36	6.0	M 8x1	26	NT 05	MT 05	HXX 4
PRP80	RCU 250600	PU 08	US 38	8.0	M 10x1	29	NT 06	MT 06	HXX 5
PRP90	RCU 200400	PU 09	US 36	6.0	M 8x1	26	NT 07	MT 07	HXX 4



PRSC(RL) EXT



Utensile esterno, bloccaggio a leva, per inserti tondi RC..

Utensile di tornitura esterno destro / sinistro, bloccaggio a leva per inserti positivi RC .. da 16 a 25. Adatto per tornitura e sfacciatura esterne e longitudinali senza spallamento, tornitura a copiare fino a 27°, tornitura conica e smussi. Disponibile con dimensioni stelo da 32x25 a 40x40 mm. Corpo trattato per una maggiore durata dell'utensile.

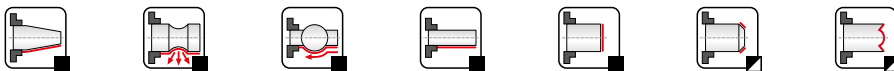
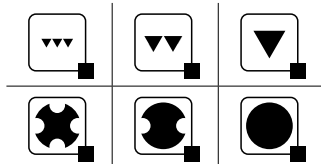
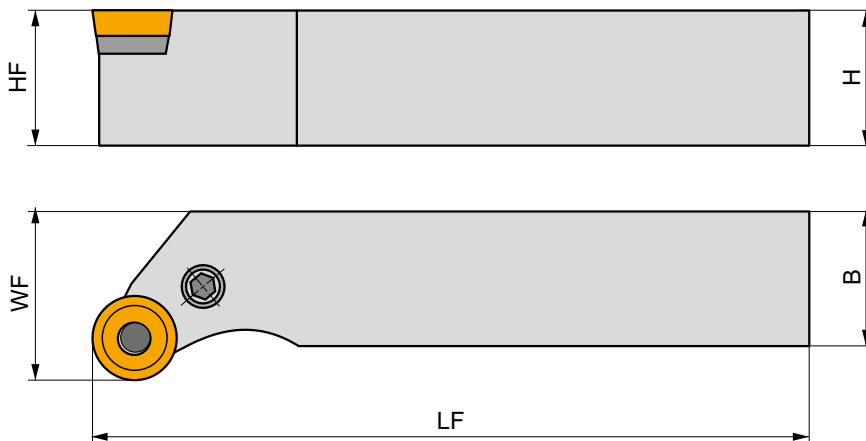
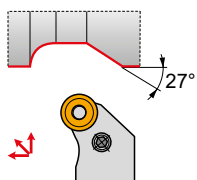

Codice prodotto	H	B	HF	WF	LF	LAMS	GAMO	kg			
	(mm)	(mm)	(mm)	(mm)	(mm)	(°)	(°)				
R	PRSCR 3225 P 16	32	25	32	32	170	0	0	0.90	GI090	PRP70
	PRSCR 4040 R 16	40	40	40	50	200	0	0	2.38	GI090	PRP70
	PRSCR 3232 P 20	32	32	32	40	170	0	0	1.40	GI069	PRP90
L	PRSCR 4040 S 25	40	40	40	50	250	0	0	3.40	GI122	PRP80
	PRSCL 3225 P 16	32	25	32	32	170	0	0	0.90	GI090	PRP70
	PRSCL 4040 R 16	40	40	40	50	200	0	0	2.38	GI090	PRP70
	PRSCL 3232 P 20	32	32	32	40	170	0	0	1.32	GI069	PRP90
PRSCL 4040 S 25	40	40	40	50	250	0	0	3.40	GI122	PRP80	



GI069
GI090
GI122

RCMX 2006MO
RCMX 1606MO
RCMX 2507MO



PRP70
PRP80
PRP90

RCU 160300
RCU 250600
RCU 200400

PU 07
PU 08
PU 09

US 36
US 38
US 36

6.0
8.0
6.0

M 8x1
M 10x1
M 8x1

26
29
26

NT 05
NT 06
NT 07

MT 05
MT 06
MT 07

HXK 4
HXK 5
HXK 4



SRDC(RL) EXT

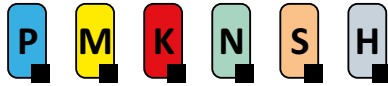

PRAMET

S



Utensile esterno, bloccaggio a vite, per inserti tondi RC..

Utensile di tornitura esterno destro / sinistro, bloccaggio a vite per inserti positivi RC..08. Adatto per sfacciatura e tornitura esterna e longitudinale senza spallamenti, conicità e smussi. Disponibile con dimensioni stelo da 20x20 fino a 32x25 mm. Corpo trattato per una maggiore durata dell'utensile.

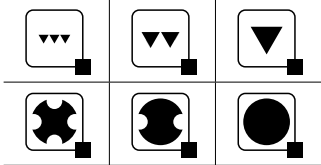
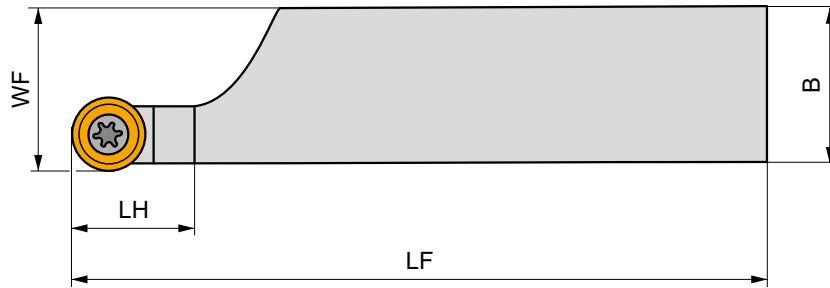

Codice prodotto	H	B	HF	WF	LF	LH	LAMS	GAMO	kg		
	(mm)	(mm)	(mm)	(mm)	(mm)	(mm)	(°)	(°)			
R SRDCR 2020 K 08-A	20	20	20	20.5	125	20	0	0	0.36	GI051	SR21
SRDCR 2525 M 08-A	25	25	25	25.5	150	20	0	0	0.66	GI051	SR21
SRDCR 3225 P 08-A	32	25	32	25.5	170	20	0	0	0.95	GI051	SR21
L SRDCL 2020 K 08-A	20	20	20	20.5	125	20	0	0	0.37	GI051	SR21
SRDCL 2525 M 08-A	25	25	25	25.5	150	20	0	0	0.66	GI051	SR21
SRDCL 3225 P 08-A	32	25	32	25.5	170	20	0	0	0.96	GI051	SR21

GI051 RC.. 0803M0

SR21 5513 020-04 Nm 1.5 M3 7.2 PT-8002



SRDCN EXT



PRAMET

S



Utensile esterno, bloccaggio a vite per inserti tondi RC..

Utensile esterno neutro di tornitura con bloccaggio a vite, per inserti positivi RC .. da 06 fino a 16. Adatto per tornitura esterna e sfacciatura senza spallamento, copiatura, tornitura conica e smussi. Disponibile con dimensioni stelo da 12x12 fino a 32x25 mm. Corpo trattato per una maggiore durata dell'utensile.

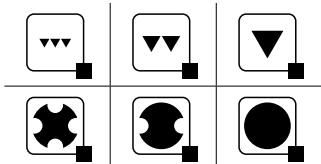
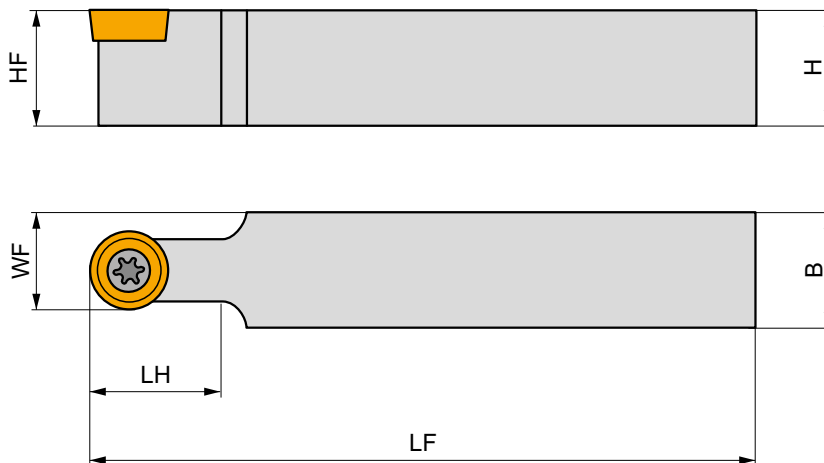
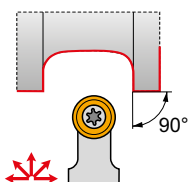

Codice prodotto	H (mm)	B (mm)	HF (mm)	WF (mm)	LF (mm)	LH (mm)	LAMS (°)	GAMO (°)	kg	GI	SR
N SRDCN 1212 F 06	12	12	12	9	80	12	0	0	0.10	GI054	S01
SRDCN 1616 H 06	16	16	16	11	100	12	0	0	0.20	GI054	S01
SRDCN 2020 K 08	20	20	20	14	125	20	0	0	0.38	GI051	S03
SRDCN 2020 K 1003-M-A	20	20	20	15	125	25	0	0	0.40	GI064	SR10
SRDCN 2020 K 10-M-A	20	20	20	15	125	25	0	0	0.40	GI013	SR10
SRDCN 2525 M 10-M-A	25	25	25	17.5	150	25	0	0	0.68	GI013	SR10
SRDCN 2525 M 12-M-A	25	25	25	18.5	150	30	0	0	0.68	GI014	SR12
SRDCN 3225 P 10-M	32	25	32	17.5	170	25	0	0	0.90	GI013	SR10
SRDCN 3225 P 12-M	32	25	32	18.5	170	30	0	0	0.90	GI014	SR12
SRDCN 3225 P 16-M	32	25	32	20.5	170	32	0	0	1.00	GI161	SR16

GI	RC..
GI013	RC.. 10T3MO
GI014	RC.. 1204MO
GI051	RC.. 0803MO
GI054	RC.. 0602MO
GI064	RC.. 1003MO
GI161	RC.. 1606MO

SR	US	Nm	M	mm	SRN	MS	FLAG	HXX
S01	US 2506-T07P	0.9	M 2.5	6.3	-	-	FLAGT07P	-
S03	US 3007-T09P	2.0	M 3	7.3	-	-	FLAGT09P	-
SR10	US 3510-T15P	3.0	M 3.5	10.6	SRN 100300	MS 3510	FLAGT15P	HXX 3.5
SR12	US 3510-T15P	3.0	M 3.5	10.6	SRN 120300	MS 3510	FLAGT15P	HXX 3.5
SR16	US 5018-T20P	5.0	M 5	18.2	SRN 16T3MO	MS 5015	FLAGT20P	HXX 5



SRSC(RL) EXT

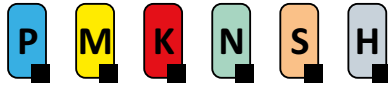

PRAMET

S



Utensile esterno, bloccaggio a vite, per inserti tondi RC..



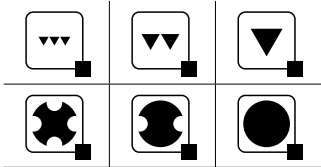
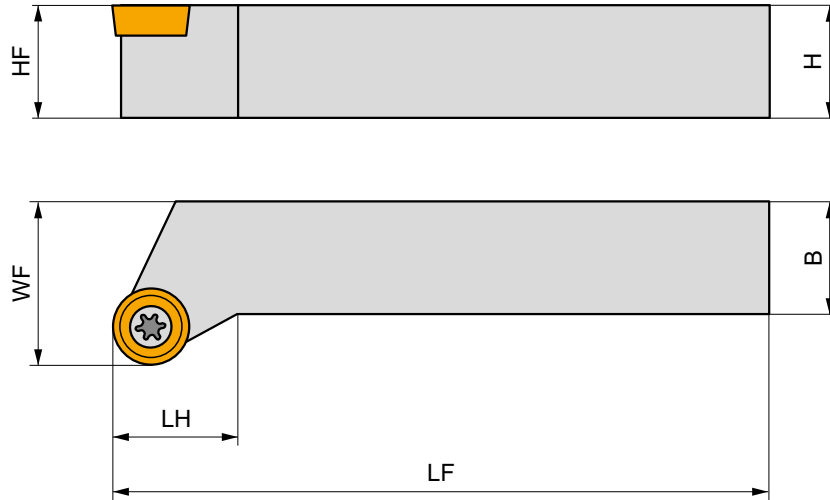
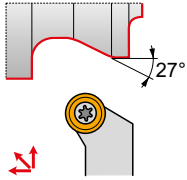





Utensile di tornitura esterno destro / sinistro, bloccaggio a vite per inserti positivi RC .. da 06 fino a 16. Adatto per sfacciatore e torniture esterne e longitudinali senza spallamento, copiatura, conicità e smussi. Disponibile con dimensioni stelo da 12x12 fino a 32x25 mm. Corpo trattato per una maggiore durata dell'utensile.



Codice prodotto	∅	B	HF	WF	LF	LH	LAMS	GAMO	kg		
	(mm)	(mm)	(mm)	(mm)	(mm)	(mm)	(°)	(°)			
R SRSCR 1212 F 06	12	12	12	16	80	12	0	0	0.09	GI054	S01
SRSCR 1616 H 06	16	16	16	20	100	12	0	0	0.22	GI054	S01
SRSCR 2020 K 08	20	20	20	25	125	20	0	0	0.45	GI051	S03
SRSCR 2020 K 10-M-A	20	20	20	25	125	20	0	0	0.45	GI013	SR10
SRSCR 2525 M 10-M-A	25	25	25	32	150	20	0	0	0.75	GI013	SR10
SRSCR 3225 P 10-M	32	25	32	32	170	20	0	0	1.06	GI013	SR10
SRSCR 2525 M 12-M-A	25	25	25	32	150	20	0	0	0.75	GI014	SR12
SRSCR 3225 P 12-M	32	25	32	32	170	20	0	0	1.07	GI014	SR12
SRSCR 3225 P 16-M	32	25	32	32	170	20	0	0	1.10	GI161	SR16
L SRSCL 1212 F 06	12	12	12	16	80	12	0	0	0.10	GI054	S01
SRSCL 1616 H 06	16	16	16	20	100	12	0	0	0.22	GI054	S01
SRSCL 2020 K 08	20	20	20	25	125	20	0	0	0.45	GI051	S03
SRSCL 2020 K 10-M-A	20	20	20	25	125	20	0	0	0.45	GI013	SR10
SRSCL 2525 M 10-M-A	25	25	25	32	150	20	0	0	0.75	GI013	SR10
SRSCL 3225 P 10-M	32	25	32	32	170	20	0	0	1.06	GI013	SR10
SRSCL 2525 M 12-M-A	25	25	25	32	150	20	0	0	0.75	GI014	SR12
SRSCL 3225 P 12-M	32	25	32	32	170	20	0	0	1.07	GI014	SR12
SRSCL 3225 P 16-M	32	25	32	32	170	20	0	0	1.10	GI161	SR16

GI013	RC.. 10T3MO
GI014	RC.. 1204MO
GI051	RC.. 0803MO
GI054	RC.. 0602MO
GI161	RC.. 1606MO



		 Nm						
S01	US 2506-T07P	0.9	M 2.5	6.3	–	–	FLAG T07P	–
S03	US 3007-T09P	2.0	M 3	7.3	–	–	FLAG T09P	–
SR10	US 3510-T15P	3.0	M 3.5	10.6	SRN 100300	MS 3510	FLAG T15P	HXK 3.5
SR12	US 3510-T15P	3.0	M 3.5	10.6	SRN 120300	MS 3510	FLAG T15P	HXK 3.5
SR16	US 5018-T20P	5.0	M 5	18.2	SRN 16T3MO	MS 5015	FLAG T20P	HXK 5



NEW

C.-SRDCN EXT

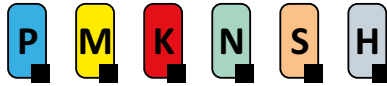

PRAMET

S



Utensile esterno PSC a cambio rapido, bloccaggio a vite, inserti RC..

Utensile esterno di tornitura, neutro, con fori per refrigerante interno, bloccaggio a vite per inserti positivi RC .. da 10 a 12. Adatto per sfacciatura e tornitura esterna longitudinale senza spallamento, copiatura, conicità e smussi. Attacco a cambio rapido PSC (Polygon Shank Coupling) dimensioni C4 e C5. Corpo trattato per una maggiore durata dell'utensile.

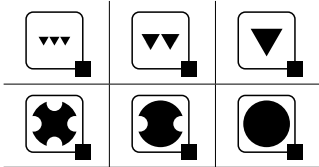
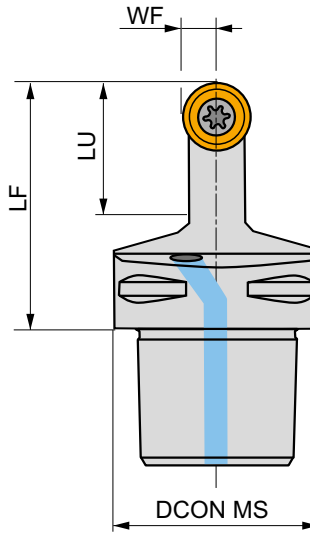
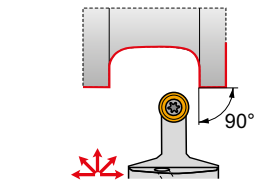

Codice prodotto	DCON MS (mm)	WF (mm)	LF (mm)	LU (mm)	LAMS (°)	GAMO (°)		kg		
N C4-SRDCN-00050-12A	40	6	50	28	0	0	✓	0.32	GI014	C-SR12V-1
C5-SRDCN-00060-10A	50	5	60	25	0	0	✓	0.56	GI013	C-SR10V
C5-SRDCN-00060-12A	50	6	60	28	0	0	✓	0.56	GI014	C-SR12V-2

GI013	RC.. 10T3MO	
GI014	RC.. 1204MO	

C-SR10V	US 2010-T15P	3.0	M 3.5	10.1	SRS 110-01	MS 9001	FLAG T15P/3,5	CN 034-02
C-SR12V-1	US 2001-T15P	3.0	M 3.5	12.1	SRS 110-02	MS 9001	FLAG T15P/3,5	CN 034-01
C-SR12V-2	US 2001-T15P	3.0	M 3.5	12.1	SRS 110-02	MS 9001	FLAG T15P/3,5	CN 034-02



KHP-RSC(RL)



PRAMET

P



Cartuccia modulare KHP con bloccaggio a leva per tornitura con inserti RC..

Cartuccia a coda di rondine, destra/sinistra, bloccaggio a leva, si monta su stelo utensile DKH. Adatta per tornitura longitudinale pesante senza spallamento, tornitura frontale, tornitura conica e smussi con inserto RC positivo .. da 20 a 32 inserti. Utensile trattato per una maggiore durata.

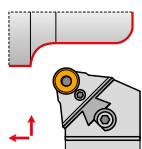

DKHR+KHP-RSCR

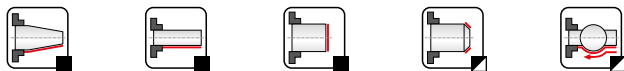
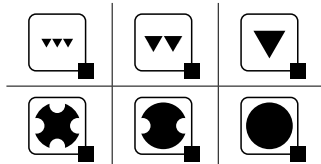
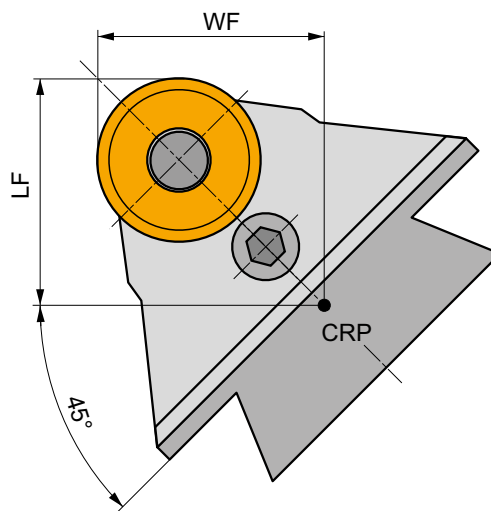

Codice prodotto	WF	LF	LAMS	GAMO	kg	G	P	
	(mm)	(mm)	(°)	(°)				
R	KHP-RSCR 20	35	45	0	0	1.25	GI069	PRP90
	KHP-RSCR 25	35	45	0	0	1.30	GI122	PRP80
	KHP-RSCR 32	35	45	0	0	1.30	GI096	PRP32
	KHP-RSCL 20	35	45	0	0	1.30	GI069	PRP90
	KHP-RSCL 25	35	45	0	0	1.30	GI122	PRP80
	KHP-RSCL 32	35	45	0	0	1.30	GI096	PRP32



GI069

RCMX 2006MO

GI096

RCMX 3209MO

GI122

RCMX 2507MO



PRP32

RCU 320600

PU 10

US 47

8.0

M 12x1

36

NT 08

MT 08

HXK 5

PRP80

RCU 250600

PU 08

US 38

8.0

M 10x1

29

NT 06

MT 06

HXK 5

PRP90

RCU 200400

PU 09

US 36

6.0

M 8x1

26

NT 07

MT 07

HXK 4



DKH(RL)



Stelo esterno per cartucce modulari KHP/KHS per tornitura pesante

Stelo modulare, destro/sinistro, a coda di rondine per cartucce KHP/KHS. Adatto per applicazioni di tornitura pesante. Dimensioni stelo 40x50 fino a 60x80mm. Corpo trattato per una durata maggiore dell'utensile.

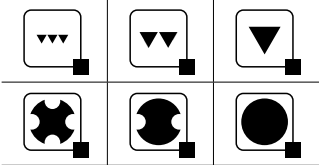
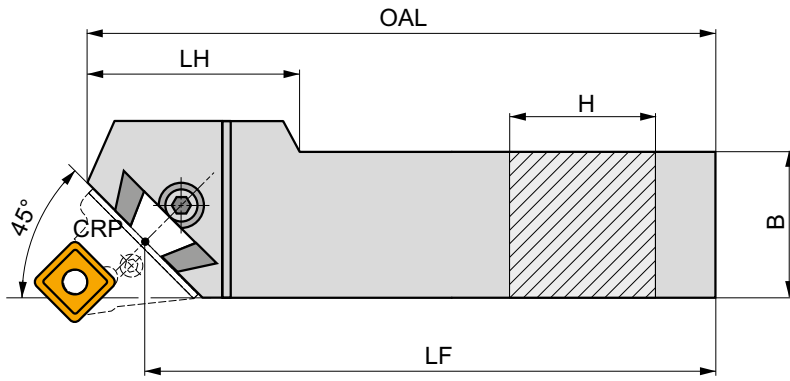
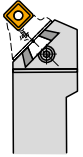

Codice prodotto	H (mm)	B (mm)	LF (mm)	OAL (mm)	LH (mm)	kg	GI098	DKH10
R DKHR 4050 V	40	50	400	425	100	7.10	GI098	DKH10
DKHR 5060 W	50	60	450	475	110	11.30	GI098	DKH10
DKHR 6080 W-A	60	80	450	485	90	19.65	GI098	DKH10
L DKHL 4050 V	40	50	400	425	100	7.10	GI098	DKH10
DKHL 5060 W	50	60	450	475	110	11.30	GI098	DKH10
DKHL 6080 W-A	60	80	450	485	90	19.28	GI098	DKH10

GI098	KHP	KHS

DKH10	SR 14	HXK 10



SC

09/ 12/ 25/ 38

INSERTI IN METALLO DURO

SCGT



134

SCMT



135

SCMW



138

ABBINAMENTO DELLA DIMENSIONE CORRETTA (esempio)

Inserto

SCMT 120408E-RM

Portainsero

SSDCN 2020 K 12-M-A

TORNITURA ISO - ESTERNA

SSBC(RL) EXT

75°

SC..

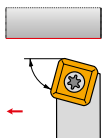
09
12
25
38

12×12
60×60

139

134 – 138

SSDCN EXT

45°

SC..

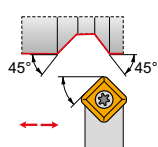
09
12

12×12
25×25

140

134 – 138

SSKC(RL) EXT

75°

SC..

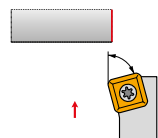
09
12

12×12
25×25

141

134 – 138

TORNITURA ISO - SGROSSATURA PESANTE - ESTERNA

KHS-SBCR + DKH(RL)

75°

SC..

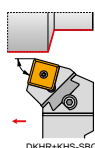
25
38

DKHR+KHS-SBC

40×50
60×80

142, 143

134 – 138

TORNITURA ISO INTERNA

SSSC(RL) INT

45°

SC..



09

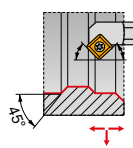

25
32

144

134 – 138



SCGT



	IC (mm)	D1 (mm)	L (mm)	S (mm)
09T3	9.525	4.40	9.53	3.97
09T3-SF3	9.525	4.40	9.53	4.22
1204	12.700	5.50	12.70	4.76

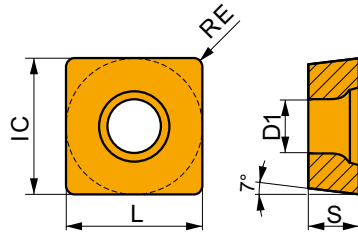

Idoneità e valori iniziali per velocità di taglio (Vc), avanzamento (f) e profondità di taglio (ap). Fare riferimento alla nostra App Machining Calculator per ulteriori calcoli.

Codice prodotto	RE (mm)	P			M			K			N			S			H		
		vc (m/min)	f (mm/rev)	ap (mm)	vc (m/min)	f (mm/rev)	ap (mm)	vc (m/min)	f (mm/rev)	ap (mm)	vc (m/min)	f (mm/rev)	ap (mm)	vc (m/min)	f (mm/rev)	ap (mm)	vc (m/min)	f (mm/rev)	ap (mm)

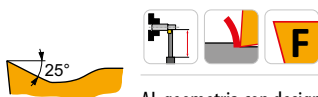

AL geometria con design altamente positivo per operazioni da finitura fino a sgrossatura, da taglio continuo a leggermente interrotto.

SCGT 120408F-AL	HF7	0.8	-	-	-	-	-	-	-	-	-	315	0.48	2.0	-	-	-	-	-	-
	T0315	0.8	-	-	-	-	-	-	-	-	-	465	0.48	2.0	-	-	-	-	-	-



NF1 geometria con design positivo per operazioni da finitura fino a medie lavorazioni, taglio continuo.

SCGT 09T308E-NF1	H07	0.8	-	-	-	100	0.13	1.2	-	-	-	510	0.17	1.2	50	0.13	1.0	-	-	-
	T6310	0.8	200	0.14	1.2	140	0.13	1.2	-	-	-	600	0.17	1.2	60	0.13	1.0	40	0.15	1.0
	T7325	0.8	225	0.14	1.2	175	0.13	1.2	-	-	-	-	-	-	70	0.13	1.0	-	-	-
SCGT 120408E-NF1	H07	0.8	-	-	-	90	0.16	1.4	-	-	-	455	0.22	1.4	45	0.16	1.1	-	-	-
	T6310	0.8	180	0.18	1.4	125	0.16	1.4	-	-	-	540	0.22	1.4	50	0.16	1.1	35	0.15	1.0
	T7325	0.8	205	0.18	1.4	155	0.16	1.4	-	-	-	-	-	-	65	0.16	1.1	-	-	-

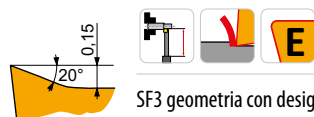

SF3 geometria con design altamente positivo per lavorazioni leggere e finitura, taglio continuo.

SCGT 09T304E-SF3	H07	0.4	-	-	-	95	0.09	1.0	155	0.10	1.0	495	0.12	1.0	50	0.07	0.8	-	-	-
	T6310	0.4	185	0.10	1.0	130	0.09	1.0	145	0.10	1.0	555	0.12	1.0	55	0.07	0.8	35	0.15	1.0
	T8315	0.4	200	0.10	1.0	120	0.09	1.0	190	0.10	1.0	600	0.12	1.0	50	0.07	0.8	40	0.15	1.0
SCGT 09T308E-SF3	T6310	0.8	210	0.12	1.0	150	0.12	1.0	165	0.12	1.0	630	0.14	1.0	60	0.11	0.8	40	0.15	1.0
	T8315	0.8	220	0.12	1.0	130	0.12	1.0	205	0.12	1.0	660	0.14	1.0	55	0.11	0.8	40	0.15	1.0



SCMT



	IC (mm)	D1 (mm)	L (mm)	S (mm)
09T3	9.525	4.40	9.53	3.97
1204	12.700	5.50	12.70	4.76
2509	25.400	8.70	25.40	9.53
3809	38.100	8.70	38.10	9.53

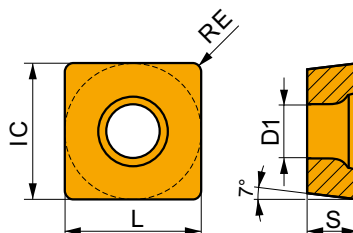

Idoneità e valori iniziali per velocità di taglio (Vc), avanzamento (f) e profondità di taglio (ap). Fare riferimento alla nostra App Machining Calculator per ulteriori calcoli.

Codice prodotto	RE (mm)	P			M			K			N			S			H		
		vc (m/min)	f (mm/rev)	ap (mm)	vc (m/min)	f (mm/rev)	ap (mm)	vc (m/min)	f (mm/rev)	ap (mm)	vc (m/min)	f (mm/rev)	ap (mm)	vc (m/min)	f (mm/rev)	ap (mm)	vc (m/min)	f (mm/rev)	ap (mm)

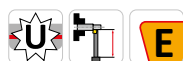
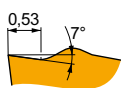

FF2 geometria positiva per operazioni da super finitura fino a finitura, da taglio continuo a leggermente interrotto.

SCMT 09T304E-FF2	T8430	0.4	210	0.12	1.2	-	-	-	175	0.12	1.2	-	-	-	-	-	-	-
	T9325	0.4	260	0.12	1.2	-	-	-	245	0.12	1.2	-	-	-	-	-	-	-
SCMT 09T308E-FF2	T8330	0.8	185	0.17	1.2	-	-	-	175	0.17	1.2	-	-	-	-	-	-	-
	T8430	0.8	220	0.17	1.2	-	-	-	180	0.17	1.2	-	-	-	-	-	-	-
	T9325	0.8	265	0.17	1.2	-	-	-	250	0.17	1.2	-	-	-	-	-	-	-

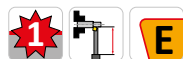

FM geometria per operazioni da finitura fino a semi sgrassatura, da taglio continuo a leggermente interrotto.

SCMT 09T304E-FM	T7325	0.4	205	0.15	1.2	155	0.15	1.2	-	-	-	-	-	-	-	-	-	-	
	T7335	0.4	200	0.15	1.2	155	0.15	1.2	-	-	-	-	-	-	-	-	-	-	
	T8315	0.4	190	0.15	1.2	110	0.14	1.2	180	0.15	1.2	570	0.18	1.2	-	-	-	-	
	T8330	0.4	180	0.15	1.2	105	0.14	1.2	170	0.15	1.2	540	0.18	1.2	-	-	-	-	
	T8430	0.4	210	0.15	1.2	115	0.14	1.2	175	0.15	1.2	585	0.18	1.2	-	-	-	-	
	T9315	0.4	290	0.15	1.2	-	-	-	275	0.15	1.2	-	-	-	-	-	-	-	-
	T9325	0.4	260	0.15	1.2	155	0.15	1.2	245	0.15	1.2	-	-	-	-	-	-	-	
SCMT 09T308E-FM	T7325	0.8	225	0.20	1.2	175	0.18	1.2	-	-	-	-	-	-	-	-	-	-	
	T7335	0.8	215	0.20	1.2	165	0.18	1.2	-	-	-	-	-	-	-	-	-	-	
	T8315	0.8	205	0.20	1.2	120	0.18	1.2	190	0.20	1.2	615	0.24	1.2	-	-	-	-	
	T8330	0.8	195	0.20	1.2	115	0.18	1.2	185	0.20	1.2	585	0.24	1.2	-	-	-	-	
	T8430	0.8	225	0.20	1.2	120	0.18	1.2	185	0.20	1.2	615	0.24	1.2	-	-	-	-	
	T9315	0.8	305	0.20	1.2	-	-	-	285	0.20	1.2	-	-	-	-	-	-	-	
	T9325	0.8	275	0.20	1.2	165	0.18	1.2	260	0.20	1.2	-	-	-	-	-	-	-	
SCMT 120404E-FM	T7325	0.4	195	0.15	1.6	150	0.15	1.6	-	-	-	-	-	-	-	-	-	-	
	T8315	0.4	185	0.15	1.6	110	0.14	1.6	175	0.15	1.6	555	0.18	1.6	-	-	-	-	
	T8330	0.4	170	0.15	1.6	100	0.14	1.6	160	0.15	1.6	510	0.18	1.6	-	-	-	-	
	T8430	0.4	205	0.15	1.6	110	0.14	1.6	170	0.15	1.6	570	0.18	1.6	-	-	-	-	
	T9315	0.4	280	0.15	1.6	-	-	-	265	0.15	1.6	-	-	-	-	-	-	-	
	T9325	0.4	250	0.15	1.6	150	0.15	1.6	235	0.15	1.6	-	-	-	-	-	-	-	
	SCMT 120408E-FM	T7325	0.8	215	0.20	1.6	165	0.18	1.6	-	-	-	-	-	-	-	-	-	-
T7335		0.8	210	0.20	1.6	160	0.18	1.6	-	-	-	-	-	-	-	-	-	-	
T8315		0.8	200	0.20	1.6	120	0.18	1.6	190	0.20	1.6	600	0.24	1.6	-	-	-	-	
T8330		0.8	190	0.20	1.6	110	0.18	1.6	180	0.20	1.6	570	0.24	1.6	-	-	-	-	
T8430		0.8	220	0.20	1.6	120	0.18	1.6	180	0.20	1.6	600	0.24	1.6	-	-	-	-	
T9315		0.8	300	0.20	1.6	-	-	-	285	0.20	1.6	-	-	-	-	-	-	-	
T9325		0.8	265	0.20	1.6	155	0.18	1.6	250	0.20	1.6	-	-	-	-	-	-	-	
SCMT 120412E-FM	T7325	1.2	210	0.27	1.6	160	0.24	1.6	-	-	-	-	-	-	-	-	-	-	
	T8330	1.2	185	0.27	1.6	110	0.24	1.6	175	0.27	1.6	555	0.32	1.6	-	-	-	-	
	T8430	1.2	200	0.27	1.6	110	0.24	1.6	165	0.27	1.6	555	0.32	1.6	-	-	-	-	
	T9315	1.2	275	0.27	1.6	-	-	-	260	0.27	1.6	-	-	-	-	-	-	-	
	T9325	1.2	245	0.27	1.6	145	0.24	1.6	230	0.27	1.6	-	-	-	-	-	-	-	



Idoneità e valori iniziali per velocità di taglio (Vc), avanzamento (f) e profondità di taglio (ap). Fare riferimento alla nostra App Machining Calculator per ulteriori calcoli.

Codice prodotto	RE  (mm)	P			M			K			N			S			H		
		vc (m/min)	f (mm/rev)	ap (mm)	vc (m/min)	f (mm/rev)	ap (mm)	vc (m/min)	f (mm/rev)	ap (mm)	vc (m/min)	f (mm/rev)	ap (mm)	vc (m/min)	f (mm/rev)	ap (mm)	vc (m/min)	f (mm/rev)	ap (mm)

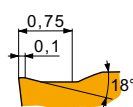

FM2 geometria per operazioni da finitura fino a lavorazioni medie, da taglio continuo a interrotto.

SCMT 09T304E-FM2	T7325	0.4	200	0.12	1.0	155	0.11	1.0	-	-	-	-	-	-	-	-	-	-
	T8430	0.4	220	0.12	1.0	120	0.11	1.0	180	0.12	1.0	-	-	-	-	-	-	-
	T9325	0.4	265	0.12	1.0	155	0.11	1.0	250	0.12	1.0	-	-	-	-	-	-	-
SCMT 09T308E-FM2	T8330	0.8	190	0.17	1.0	110	0.15	1.0	180	0.17	1.0	-	-	-	-	-	-	-
	T8430	0.8	225	0.17	1.0	120	0.15	1.0	185	0.17	1.0	-	-	-	-	-	-	-
	T9315	0.8	305	0.17	1.0	-	-	-	285	0.17	1.0	-	-	-	-	-	-	-
	T9325	0.8	270	0.17	1.0	160	0.15	1.0	255	0.17	1.0	-	-	-	-	-	-	-
	T9335	0.8	235	0.17	1.0	140	0.15	1.0	-	-	-	-	-	-	-	-	-	-

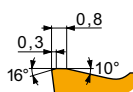

RF geometria per operazioni da semi sgrassatura fino a sgrassatura, da taglio continuo a interrotto.

SCMT 09T308E-RF	T5315	0.8	255	0.20	1.5	-	-	-	240	0.20	1.5	-	-	-	-	-	50	0.15	1.0
	T7335	0.8	170	0.20	1.5	130	0.18	1.5	-	-	-	-	-	-	-	-	-	-	
	T9325	0.8	220	0.20	1.5	130	0.18	1.5	205	0.20	1.5	-	-	-	-	-	-	-	
SCMT 120408E-RF	T5315	0.8	240	0.22	2.2	-	-	-	225	0.22	2.2	-	-	-	-	-	45	0.15	1.0
	T7335	0.8	160	0.22	2.2	120	0.22	2.2	-	-	-	-	-	-	-	-	-	-	
	T9325	0.8	205	0.22	2.2	120	0.22	2.2	190	0.22	2.2	-	-	-	-	-	-	-	

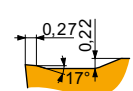

RM geometria per operazioni da semi sgrassatura fino a sgrassatura, da taglio continuo a interrotto.

SCMT 09T308E-RM	T5315	0.8	275	0.30	2.0	-	-	-	260	0.30	2.0	-	-	-	-	-	55	0.15	1.0	
	T7335	0.8	190	0.30	2.0	145	0.27	2.0	-	-	-	60	0.24	1.6	-	-	-	-		
	T8330	0.8	175	0.30	2.0	105	0.27	2.0	165	0.30	2.0	-	-	-	40	0.24	1.6	35	0.15	1.0
	T8430	0.8	190	0.30	2.0	105	0.27	2.0	155	0.30	2.0	-	-	-	40	0.24	1.6	30	0.15	1.0
	T9315	0.8	255	0.30	2.0	-	-	-	240	0.30	2.0	-	-	-	-	-	-	50	0.15	1.0
	T9325	0.8	230	0.30	2.0	135	0.27	2.0	215	0.30	2.0	-	-	-	50	0.24	1.6	-	-	-
SCMT 120408E-RM	T5305	0.8	305	0.30	2.3	-	-	-	285	0.30	2.3	-	-	-	-	-	60	0.15	1.0	
	T5315	0.8	275	0.30	2.3	-	-	-	260	0.30	2.3	-	-	-	-	-	55	0.15	1.0	
	T7335	0.8	185	0.30	2.3	140	0.27	2.3	-	-	-	60	0.24	1.8	-	-	-	-		
	T8330	0.8	175	0.30	2.3	105	0.27	2.3	165	0.30	2.3	-	-	-	40	0.24	1.8	35	0.15	1.0
	T8430	0.8	190	0.30	2.3	105	0.27	2.3	155	0.30	2.3	-	-	-	40	0.24	1.8	30	0.15	1.0
	T9315	0.8	250	0.30	2.3	-	-	-	235	0.30	2.3	-	-	-	-	-	-	50	0.15	1.0
	T9325	0.8	225	0.30	2.3	135	0.27	2.3	210	0.30	2.3	-	-	-	50	0.24	1.8	-	-	-

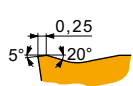

RM3 geometria per operazioni da semi sgrassatura fino a sgrassatura, da taglio continuo a interrotto.

SCMT 120408E-RM3	T6310	0.8	155	0.27	2.3	110	0.27	2.3	125	0.27	2.3	-	-	-	-	-	30	0.15	1.0
	T8330	0.8	155	0.27	2.3	90	0.27	2.3	145	0.27	2.3	-	-	-	-	-	30	0.15	1.0
	T8430	0.8	170	0.27	2.3	90	0.27	2.3	135	0.27	2.3	-	-	-	-	-	25	0.15	1.0
	T9315	0.8	225	0.27	2.3	-	-	-	210	0.27	2.3	-	-	-	-	-	45	0.15	1.0
	T9325	0.8	205	0.27	2.3	120	0.27	2.3	190	0.27	2.3	-	-	-	-	-	-	-	-
	T9335	0.8	175	0.27	2.3	105	0.27	2.3	-	-	-	-	-	-	-	-	-	-	-
SCMT 120412E-RM3	T7325	1.2	175	0.30	2.3	135	0.27	2.3	-	-	-	-	-	-	-	-	-	-	
	T9325	1.2	205	0.30	2.3	120	0.27	2.3	190	0.30	2.3	-	-	-	-	-	-	-	



Idoneità e valori iniziali per velocità di taglio (Vc), avanzamento (f) e profondità di taglio (ap). Fare riferimento alla nostra App Machining Calculator per ulteriori calcoli.

Codice prodotto	RE  (mm)	P			M			K			N			S			H		
		vc (m/min)	f (mm/rev)	ap (mm)	vc (m/min)	f (mm/rev)	ap (mm)	vc (m/min)	f (mm/rev)	ap (mm)	vc (m/min)	f (mm/rev)	ap (mm)	vc (m/min)	f (mm/rev)	ap (mm)	vc (m/min)	f (mm/rev)	ap (mm)

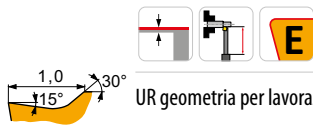

UR geometria per lavorazioni leggere e finitura, da taglio continuo a leggermente interrotto.

SCMT 09T304E-UR	T7325	0.4	175	0.15	1.2	135	0.15	1.2	-	-	-	-	-	-	-	-	-	-	
	T8330	0.4	155	0.15	1.2	90	0.14	1.2	145	0.15	1.2	-	-	-	-	-	-	-	
	T8430	0.4	180	0.15	1.2	95	0.14	1.2	145	0.15	1.2	-	-	-	-	-	-	-	
	T9315	0.4	250	0.15	1.2	-	-	-	235	0.15	1.2	-	-	-	-	-	-	-	-
	T9325	0.4	225	0.15	1.2	135	0.15	1.2	210	0.15	1.2	-	-	-	-	-	-	-	
SCMT 09T308E-UR	T5315	0.8	280	0.20	1.2	-	-	-	265	0.20	1.2	-	-	-	-	-	-	-	
	T7325	0.8	195	0.20	1.2	150	0.18	1.2	-	-	-	-	-	-	-	-	-	-	
	T8330	0.8	170	0.20	1.2	100	0.18	1.2	160	0.20	1.2	-	-	-	-	-	-	-	
	T8430	0.8	190	0.20	1.2	105	0.18	1.2	155	0.20	1.2	-	-	-	-	-	-	-	
	T9315	0.8	260	0.20	1.2	-	-	-	245	0.20	1.2	-	-	-	-	-	-	-	
SCMT 120408E-UR	T9325	0.8	235	0.20	1.2	140	0.18	1.2	220	0.20	1.2	-	-	-	-	-	-	-	
	TT310	0.8	270	0.20	1.2	160	0.18	1.2	-	-	-	-	-	-	-	-	-	-	
	T5315	0.8	270	0.20	1.6	-	-	-	255	0.20	1.6	-	-	-	-	-	-	-	
	T7325	0.8	185	0.20	1.6	140	0.18	1.6	-	-	-	-	-	-	-	-	-	-	
	T8330	0.8	165	0.20	1.6	95	0.18	1.6	155	0.20	1.6	-	-	-	-	-	-	-	
SCMT 120412E-UR	T8430	0.8	185	0.20	1.6	100	0.18	1.6	150	0.20	1.6	-	-	-	-	-	-	-	
	T9315	0.8	260	0.20	1.6	-	-	-	245	0.20	1.6	-	-	-	-	-	-	-	
	T9325	0.8	230	0.20	1.6	135	0.18	1.6	215	0.20	1.6	-	-	-	-	-	-	-	
	T8330	1.2	160	0.27	1.6	95	0.24	1.6	150	0.27	1.6	-	-	-	-	-	-	-	
	T8430	1.2	175	0.27	1.6	95	0.24	1.6	140	0.27	1.6	-	-	-	-	-	-	-	
T9325	1.2	215	0.27	1.6	125	0.24	1.6	200	0.27	1.6	-	-	-	-	-	-	-		

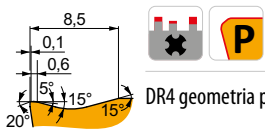

DR4 geometria per operazioni da sgrossatura fino a sgrossatura pesante, da taglio continuo a interrotto.

SCMT 380932E-DR4	T9335	3.2	50	1.33	16.0	30	1.20	16.0	-	-	-	-	-	-	-	-	-	-
------------------	-------	-----	----	------	------	----	------	------	---	---	---	---	---	---	---	---	---	---

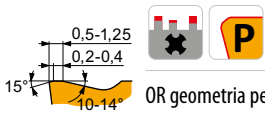

OR geometria per operazioni da sgrossatura fino a sgrossatura pesante, da taglio continuo a interrotto.

SCMT 250924E-OR	T9226	2.4	80	1.00	10.0	45	0.90	10.0	75	1.00	10.0	-	-	-	15	0.70	8.0	-	-	-
	T9325	2.4	90	1.00	10.0	50	0.90	10.0	85	1.00	10.0	-	-	-	20	0.70	8.0	-	-	-
	T9335	2.4	70	1.00	10.0	40	0.90	10.0	-	-	-	-	-	-	15	0.70	8.0	-	-	-
SCMT 380932E-OR	6635	3.2	60	1.20	18.0	35	1.08	18.0	-	-	-	-	-	-	15	1.08	9.9	-	-	-
	T9226	3.2	65	1.20	18.0	35	1.08	18.0	60	1.20	18.0	-	-	-	10	1.08	9.9	-	-	-
	T9315	3.2	85	1.20	18.0	-	-	-	80	1.20	18.0	-	-	-	-	-	-	-	-	-
	T9325	3.2	80	1.20	18.0	45	1.08	18.0	75	1.20	18.0	-	-	-	15	1.08	9.9	-	-	-
	T9335	3.2	60	1.20	18.0	35	1.08	18.0	-	-	-	-	-	-	10	1.08	9.9	-	-	-

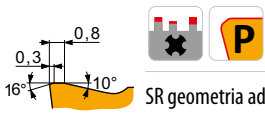

SR geometria adatta per operazioni da sgrossatura fino a sgrossatura pesante, da taglio continuo a interrotto.

SCMT 250924E-SR	T9325	2.4	70	1.00	14.0	40	0.90	14.0	65	1.00	14.0	-	-	-	-	-	-	-
	T9335	2.4	60	1.00	14.0	35	0.90	14.0	-	-	-	-	-	-	-	-	-	-
SCMT 380932E-SR	T9335	3.2	50	1.30	20.0	30	1.30	20.0	-	-	-	-	-	-	-	-	-	-



SCMW



	IC	D1	L	S
	(mm)	(mm)	(mm)	(mm)
09T3	9.525	4.40	9.53	3.97
1204	12.700	5.50	12.70	4.76

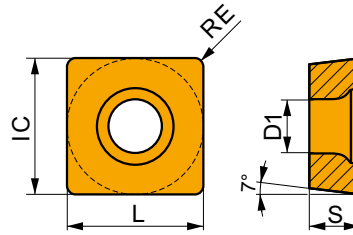

Idoneità e valori iniziali per velocità di taglio (Vc), avanzamento (f) e profondità di taglio (ap). Fare riferimento alla nostra App Machining Calculator per ulteriori calcoli.

Codice prodotto	RE (mm)	P			M			K			N			S			H		
		vc (m/min)	f (mm/rev)	ap (mm)	vc (m/min)	f (mm/rev)	ap (mm)	vc (m/min)	f (mm/rev)	ap (mm)	vc (m/min)	f (mm/rev)	ap (mm)	vc (m/min)	f (mm/rev)	ap (mm)	vc (m/min)	f (mm/rev)	ap (mm)

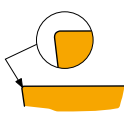

Adatta per operazioni da finitura fino a semi sgrossatura, da taglio continuo a leggermente interrotto.

SCMW 09T304	T5305	0.4	-	-	-	-	-	-	240	0.10	2.0	-	-	-	-	-	-	50	0.15	1.0
	T5315	0.4	-	-	-	-	-	-	205	0.10	2.0	-	-	-	-	-	-	40	0.15	1.0
SCMW 09T308	T5305	0.8	-	-	-	-	-	-	220	0.20	2.0	-	-	-	-	-	-	45	0.15	1.0
	T5315	0.8	-	-	-	-	-	-	190	0.20	2.0	-	-	-	-	-	-	40	0.15	1.0
SCMW 120408	T5305	0.8	-	-	-	-	-	-	205	0.20	4.0	-	-	-	-	-	-	40	0.15	1.0
	T5315	0.8	-	-	-	-	-	-	185	0.20	4.0	-	-	-	-	-	-	35	0.15	1.0



SSBC(RL) EXT



Utensile esterno, bloccaggio a vite, angolo del tagliente utensile 75°, inserti SC..

Utensile di tornitura esterno destro / sinistro, bloccaggio a vite per inserti positivi SC .. da 09 fino a 38. Adatto per tornitura longitudinale esterna senza spallamenti, conica e smussi. Disponibile con dimensioni stelo da 12x12 fino a 60x60 mm. Corpo trattato per una maggiore durata dell'utensile.

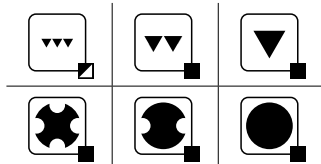
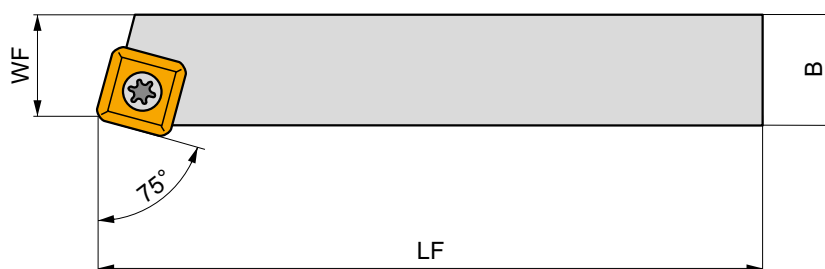
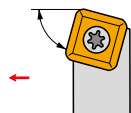

Codice prodotto	H	B	HF	WF	LF	LAMS	GAMO	kg			
	(mm)	(mm)	(mm)	(mm)	(mm)	(°)	(°)				
R	SSBCR 1212 F 09	12	12	12	11	80	0	0	0.10	GI053	S08
	SSBCR 1616 H 09	16	16	16	13	100	0	0	0.20	GI053	S08
	SSBCR 2020 K 12-M-A	20	20	20	17	125	0	0	0.40	GI015	SS20
	SSBCR 2525 M 12-M-A	25	25	25	22	150	0	0	0.76	GI015	SS20
	SSBCR 4040 S 25	40	40	40	35	250	0	0	3.01	GI131	SS25
	SSBCR 5050 T 25	50	50	50	43	300	0	0	5.65	GI131	SS25
	SSBCR 5050 T 38-A	50	50	50	43	300	0	0	4.84	GI164	SS38A
L	SSBCR 6060 V 38-A	60	60	60	53	400	0	0	11.10	GI164	SS38A
	SSBCL 1212 F 09	12	12	12	11	80	0	0	0.10	GI053	S08
	SSBCL 1616 H 09	16	16	16	13	100	0	0	0.22	GI053	S08
	SSBCL 2020 K 12-M-A	20	20	20	17	125	0	0	0.40	GI015	SS20
	SSBCL 2525 M 12-M-A	25	25	25	22	150	0	0	0.47	GI015	SS20
	SSBCL 4040 S 25	40	40	40	35	250	0	0	3.01	GI131	SS25
	SSBCL 5050 T 25	50	50	50	43	300	0	0	5.65	GI131	SS25
SSBCL 5050 T 38-A	50	50	50	43	300	0	0	5.78	GI164	SS38A	
SSBCL 6060 V 38-A	60	60	60	53	400	0	0	11.16	GI164	SS38A	



GI015
GI053
GI131
GI164

SC.. 1204..
SC.. 09T3..
SC.. 2509..
SC.. 3809..



S08
SS20
SS25
SS38A

US 3510-T15P
US 5012-T15P
US 8025-T30P
US 8025-T30P

3.0
5.0
13.0
13.0

M 3.5
M 5
M 8
M 8

10.6
12.2
24.2
24.2

-
SSN 120304
SSN 250620
SSN 380920

-
MS 5008
MS 8020
MS 8020

FLAG T15P
FLAG T15P
-
-

-
HXK 5
HXK 5
HXK 5

-
-
SDR T30P
SDR T30P



SSDCN EXT

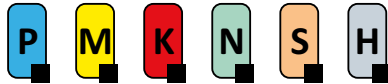

PRAMET

S



Utensile esterno, bloccaggio a vite, angolo del tagliente utensile 45°, inserti SC..

Utensile esterno di tornitura, neutro, bloccaggio a vite, per inserti positivi SC .. 09 o 12. Adatto per tornitura longitudinale esterna senza spallamento, copiatura, tornitura conica e smussi. Disponibile con dimensioni stelo da 12x12 fino a 25x25 mm. Corpo trattato per una maggiore durata dell'utensile.

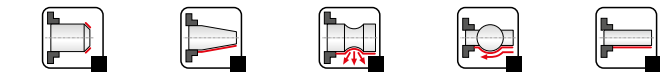
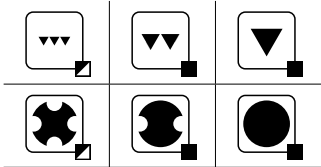
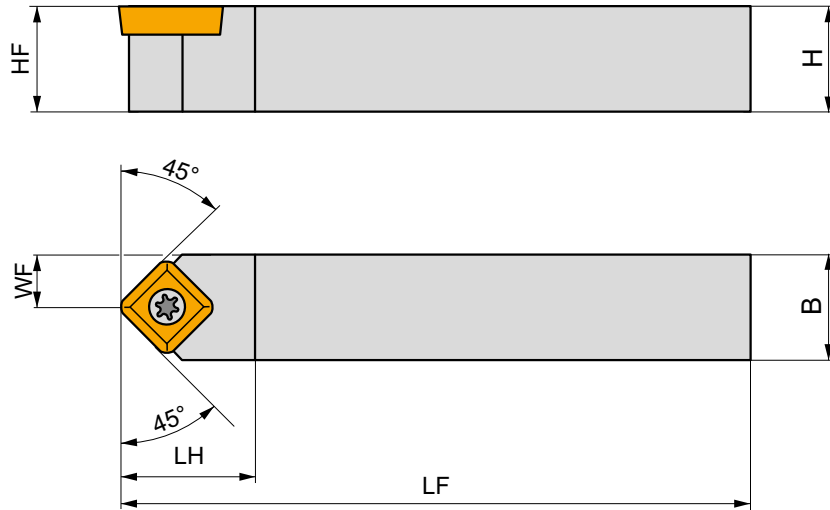
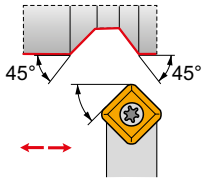

Codice prodotto	H	B	HF	WF	LF	LH	LAMS	GAMO	kg		
	(mm)	(mm)	(mm)	(mm)	(mm)	(mm)	(°)	(°)			
SSDCN 1212 F 09	12	12	12	6	80	-	0	0	0.12	GI053	S08
SSDCN 1616 H 09	16	16	16	8	100	-	0	0	0.20	GI053	S08
SSDCN 2020 K 12-M-A	20	20	20	10	125	-	0	0	0.42	GI015	SS20
SSDCN 2525 M 12-M-A	25	25	25	12.5	150	-	0	0	0.74	GI015	SS20

GI015					SC.. 1204..						
GI053					SC.. 09T3..						

S08	US 3510-T15P	3.0	M 3.5	10.6	-	-	FLAG T15P	-			
SS20	US 5012-T15P	5.0	M 5	12.2	SSN 120304	MS 5008	FLAG T15P	HXK 5			



SSKC(RL) EXT



Utensile esterno, bloccaggio a vite, angolo del tagliente utensile 75° (sfacciare), inserti SC..

Utensile di tornitura esterno destro / sinistro con bloccaggio a vite, per inserti positivi SC.. da 09 fino a 12. Adatto per sfacciatura senza spallamenti e smussi. Disponibile con dimensioni stelo da 12x12 fino a 25x25 mm. Corpo trattato per una maggiore durata dell'utensile.

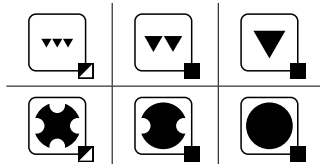
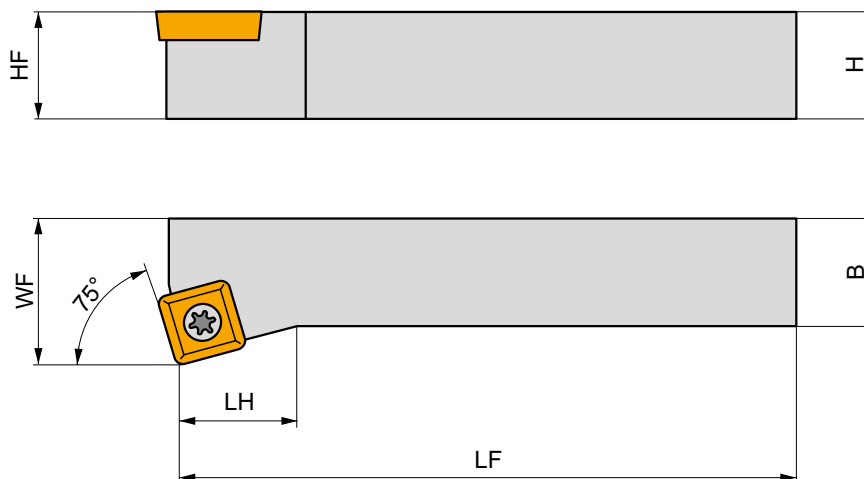
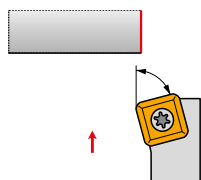

Codice prodotto	H	B	HF	WF	LF	LH	LAMS	GAMO	kg			
	(mm)	(mm)	(mm)	(mm)	(mm)	(mm)	(°)	(°)				
R	SSKCR 1212 F 09	12	12	12	16	80	32	0	0	0.10	GI053	S08
	SSKCR 1616 H 09	16	16	16	20	100	32	0	0	0.25	GI053	S08
	SSKCR 2020 K 12-M-A	20	20	20	25	125	36	0	0	0.75	GI015	SS20
	SSKCR 2525 M 12-M-A	25	25	25	32	150	36	0	0	0.75	GI015	SS20
L	SSKCL 1212 F 09	12	12	12	16	80	32	0	0	0.10	GI053	S08
	SSKCL 1616 H 09	16	16	16	20	100	32	0	0	0.22	GI053	S08
	SSKCL 2020 K 12-M-A	20	20	20	25	125	36	0	0	0.45	GI015	SS20
	SSKCL 2525 M 12-M-A	25	25	25	32	150	36	0	0	0.80	GI015	SS20



GI015

GI053



SC.. 1204..

SC.. 09T3..



S08

SS20



US 3510-T15P

US 5012-T15P



3.0

5.0



M 3.5

M 5



10.6

12.2



-

SSN 120304



-

MS 5008



FLAG T15P

FLAG T15P



-

HXK 5



KHS-SBC(RL)



PRAMET

S



Cartuccia di tornitura KHP, bloccaggio a vite, angolo del tagliente utensile 75°, inserti SC..

Cartuccia a coda di rondine, destra/sinistra, bloccaggio a vite, angolo del tagliente utensile 75°, si monta su stelo utensili DKH. Adatta per tornitura longitudinale pesante senza spallamento, tornitura frontale, conica e smussi con inserti positivi SC..25 o 38. Utensile trattato per una maggiore durata.

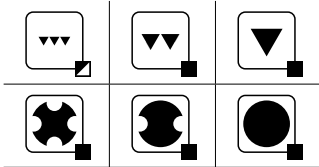
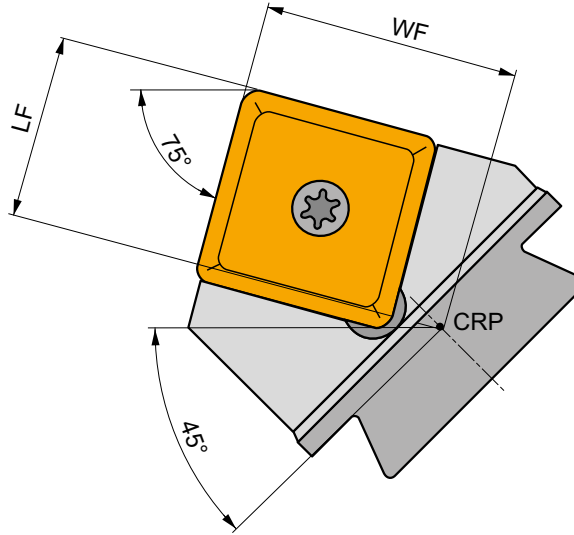
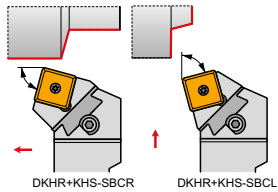

Codice prodotto	WF (mm)	LF (mm)	LAMS (°)	GAMO (°)	kg		
R KHS-SBCR 25	47	36	0	0	1.50	G1131	SS26
KHS-SBCR 38-A	47	36	0	0	1.50	G1164	SS38
L KHS-SBCL 25	47	36	0	0	1.45	G1131	SS26
KHS-SBCL 38-A	47	36	0	0	1.48	G1164	SS38

G1131	SC.. 2509..
G1164	SC.. 3809..

SS26	US 8025-T30P	13.0	M 8	24.2	SSN 250620	MS 8020	SDR T30P	HXK 5
SS38	US 8025-T30P	13.0	M 8	24.2	SSN 380620	MS 8020	SDR T30P	HXK 5



DKH(RL)



Stelo esterno per cartucce modulari KHP/KHS per tornitura pesante

Stelo modulare, destro/sinistro, a coda di rondine per cartucce KHP/KHS. Adatto per applicazioni di tornitura pesante. Dimensioni stelo 40x50 fino a 60x80mm. Corpo trattato per una durata maggiore dell'utensile.

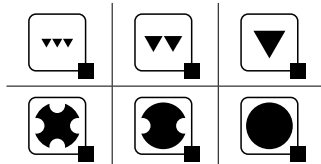
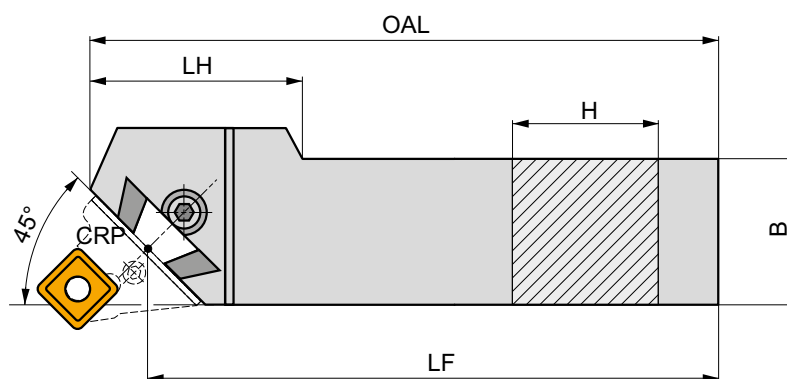
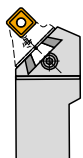

Codice prodotto	H	B	LF	OAL	LH	kg		
	(mm)	(mm)	(mm)	(mm)	(mm)			
R	DKHR 4050 V	40	50	400	425	7.10	GI098	DKH10
	DKHR 5060 W	50	60	450	475	11.30	GI098	DKH10
	DKHR 6080 W-A	60	80	450	485	19.65	GI098	DKH10
L	DKHL 4050 V	40	50	400	425	7.10	GI098	DKH10
	DKHL 5060 W	50	60	450	475	11.30	GI098	DKH10
	DKHL 6080 W-A	60	80	450	485	19.28	GI098	DKH10



GI098



KHP



KHS



DKH10



SR 14



HXK 10



SSSC(RL) INT

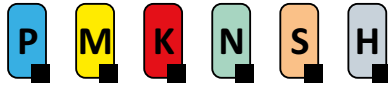

PRAMET

S



Utensile interno, bloccaggio a vite, inserti SC... angolo del tagliente utensile 45°

Bareno destro/sinistro per tornitura interna con bloccaggio a vite, angolo del tagliente utensile 45° per inserto positivo SC...09. Diametro interno minimo tornibile Ø25 mm. Adatto per operazioni di retro smussi, conicità, tornitura multidirezionale e longitudinale con spallamento. Disponibile con stelo da Ø20 mm a Ø25 mm. Corpo trattato per una maggiore durata.

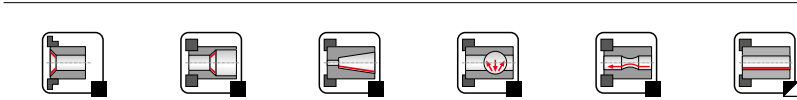
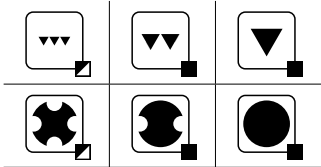
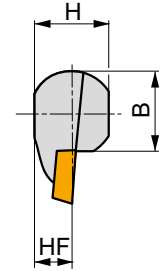
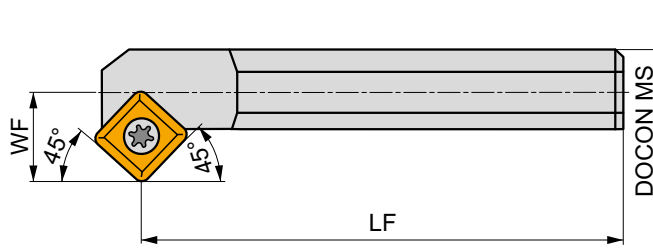
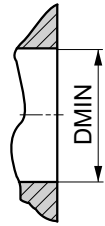
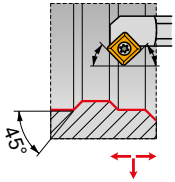

Codice prodotto	DOCON MS (mm)	DMIN (mm)	WF (mm)	H (mm)	B (mm)	LF (mm)	LAMS (°)	GAMO (°)	kg	GI053	S04
R S20S-SSSCR 09	20	25	13	18	18.5	250	-5	0	0.61	GI053	S04
S25T-SSSCR 09	25	32	17	23	23	300	-3	0	1.15	GI053	S04
L S20S-SSSCL 09	20	25	13	18	18.5	250	-5	0	0.05	GI053	S04
S25T-SSSCL 09	25	32	17	23	23	300	-3	0	1.11	GI053	S04

GI053	SC..09T3..
-------	------------

S04	US 3510-T15P	3.0 Nm	M 3.5	10.6	FLAGT15P
-----	--------------	--------	-------	------	----------

**SP**

09/ 12/ 15/ 19/ 25

INSERTI IN METALLO DURO**SPMR**

146

SPUN

146

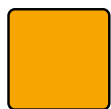
INSERTI CER**SPGN CER**

147



SPMR



	IC (mm)	L (mm)	S (mm)
0903	9.525	9.53	3.18
1203	12.700	12.70	3.18

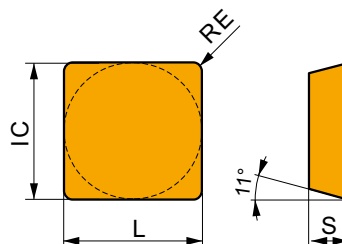

Idoneità e valori iniziali per velocità di taglio (Vc), avanzamento (f) e profondità di taglio (ap). Fare riferimento alla nostra App Machining Calculator per ulteriori calcoli.

Codice prodotto	RE (mm)	P			M			K			N			S			H		
		vc (m/min)	f (mm/rev)	ap (mm)	vc (m/min)	f (mm/rev)	ap (mm)	vc (m/min)	f (mm/rev)	ap (mm)	vc (m/min)	f (mm/rev)	ap (mm)	vc (m/min)	f (mm/rev)	ap (mm)	vc (m/min)	f (mm/rev)	ap (mm)

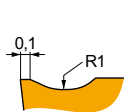

46 geometria per operazioni leggere e finitura, da taglio continuo a interrotto.

SPMR 090304E-46	T9325	0.4	215	0.15	1.0	125	0.15	1.0	200	0.15	1.0	-	-	-	-	-	-	-	-
SPMR 090308E-46	T9325	0.8	255	0.15	1.0	150	0.15	1.0	240	0.15	1.0	-	-	-	-	-	-	-	-

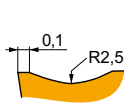

48 geometria per operazioni da finitura fino a semi sgrassatura, taglio continuo e interrotto.

SPMR 120304E-48	T9325	0.4	170	0.22	2.2	100	0.22	2.2	160	0.22	2.2	-	-	-	-	-	-	-	-
	T9335	0.4	145	0.22	2.2	85	0.22	2.2	-	-	-	-	-	-	-	-	-	-	-
SPMR 120308E-48	6640	0.8	160	0.22	2.2	95	0.22	2.2	150	0.22	2.2	-	-	-	-	-	-	-	-
	T9325	0.8	205	0.22	2.2	120	0.22	2.2	190	0.22	2.2	-	-	-	-	-	-	-	-
	T9335	0.8	175	0.22	2.2	105	0.22	2.2	-	-	-	-	-	-	-	-	-	-	-
SPMR 120312E-48	T9325	1.2	215	0.22	2.2	125	0.22	2.2	200	0.22	2.2	-	-	-	-	-	-	-	-

SPUN



	IC (mm)	L (mm)	M (mm)	S (mm)
1203	12.700	12.70	2	3.18
1504	15.875	15.88	3	4.76
1904	19.050	19.05	3	4.76
2506	25.400	25.40	4	6.35

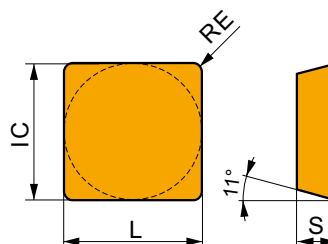

Idoneità e valori iniziali per velocità di taglio (Vc), avanzamento (f) e profondità di taglio (ap). Fare riferimento alla nostra App Machining Calculator per ulteriori calcoli.

Codice prodotto	RE (mm)	P			M			K			N			S			H		
		vc (m/min)	f (mm/rev)	ap (mm)	vc (m/min)	f (mm/rev)	ap (mm)	vc (m/min)	f (mm/rev)	ap (mm)	vc (m/min)	f (mm/rev)	ap (mm)	vc (m/min)	f (mm/rev)	ap (mm)	vc (m/min)	f (mm/rev)	ap (mm)

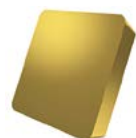

Adatta per operazioni da finitura fino a semi sgrassatura, da taglio continuo a leggermente interrotto.

SPUN 120308	6640	0.8	180	0.15	4.0	-	-	-	170	0.15	4.0	-	-	-	-	-	-	-	-
SPUN 120312	6640	1.2	190	0.15	4.0	-	-	-	180	0.15	4.0	-	-	-	-	-	-	-	-
SPUN 150408	6640	0.8	155	0.20	5.0	-	-	-	145	0.20	5.0	-	-	-	-	-	-	-	-



Idoneità e valori iniziali per velocità di taglio (Vc), avanzamento (f) e profondità di taglio (ap). Fare riferimento alla nostra App Machining Calculator per ulteriori calcoli.

Codice prodotto	RE (mm)	P			M			K			N			S			H		
		vc (m/min)	f (mm/rev)	ap (mm)	vc (m/min)	f (mm/rev)	ap (mm)	vc (m/min)	f (mm/rev)	ap (mm)	vc (m/min)	f (mm/rev)	ap (mm)	vc (m/min)	f (mm/rev)	ap (mm)	vc (m/min)	f (mm/rev)	ap (mm)



Adatta per operazioni da finitura fino a semi sgrossatura, da taglio continuo a leggermente interrotto.

SPUN 150412	6640	1.2	165	0.20	5.0	—	—	—	155	0.20	5.0	—	—	—	—	—	—	—
SPUN 190408	6640	0.8	150	0.20	6.0	—	—	—	140	0.20	6.0	—	—	—	—	—	—	—
SPUN 190412	6640	1.2	160	0.20	6.0	—	—	—	150	0.20	6.0	—	—	—	—	—	—	—
SPUN 190416	6640	1.6	165	0.20	6.0	—	—	—	155	0.20	6.0	—	—	—	—	—	—	—

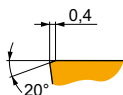

Adatta per operazioni da finitura fino a semi sgrossatura, da taglio continuo a leggermente interrotto.

SPUN 250620S	6640	2.0	80	0.40	12.0	—	—	—	75	0.40	12.0	—	—	—	—	—	—	—
--------------	------	-----	----	------	------	---	---	---	----	------	------	---	---	---	---	---	---	---

SPGN CER



	IC (mm)	L (mm)	S (mm)
1203	12.700	12.70	3.18

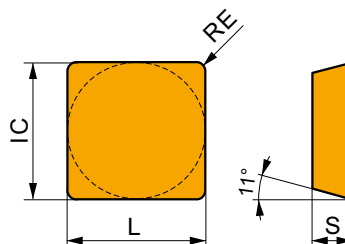

Idoneità e valori iniziali per velocità di taglio (Vc), avanzamento (f) e profondità di taglio (ap). Fare riferimento alla nostra App Machining Calculator per ulteriori calcoli.

Codice prodotto	RE (mm)	P			M			K			N			S			H		
		vc (m/min)	f (mm/rev)	ap (mm)	vc (m/min)	f (mm/rev)	ap (mm)	vc (m/min)	f (mm/rev)	ap (mm)	vc (m/min)	f (mm/rev)	ap (mm)	vc (m/min)	f (mm/rev)	ap (mm)	vc (m/min)	f (mm/rev)	ap (mm)

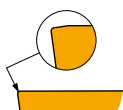

Adatta per lavorazioni con elevata velocità e taglio continuo.

SPGN 120308 T01020	TC100	0.8	—	—	—	—	—	—	530	0.20	1.5	—	—	—	—	—	—	—
--------------------	-------	-----	---	---	---	---	---	---	-----	------	-----	---	---	---	---	---	---	---





TC

06/ 09/ 11/16

INSERTI IN METALLO DURO

TCGT



 149

TCMT



 150

TCMW



 154

INSERTI CBN

TCGW CBN



 154

ABBINAMENTO DELLA DIMENSIONE CORRETTA (esempio)

Inserto	Portainserito
TCMT 110204E-FF2	STFCR 1616 H 11

TORNITURA ISO - ESTERNA

STFC(RL) EXT

90°

TC..

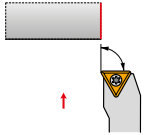

 155

 149 - 154

16x16
25x25

STFC(RL)-A EXT

90°

TC..

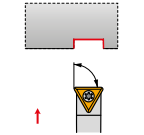

 156

 149 - 154

20x20

STJC(RL) EXT

93°

TC..

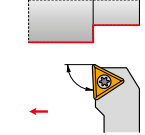

 157

 149 - 154

16x16
25x25

TORNITURA ISO INTERNA

STFC(RL) INT

90°

TC..

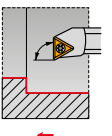

 158

 149 - 154

06
09
11
16

8,5
40

STFC(RL)-E INT

90°

TC..

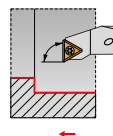

 160

 149 - 154

06
09
11

8,5
20



TCGT



	IC (mm)	D1 (mm)	L (mm)	S (mm)
06T1	3.970	2.20	6.90	1.98
0902	5.560	2.50	9.60	2.38
1102	6.350	2.80	11.00	2.38
1102-SF3	6.350	2.80	11.00	2.58
16T3	9.525	4.40	16.50	3.97
16T3-SF3	9.525	4.40	16.50	4.22

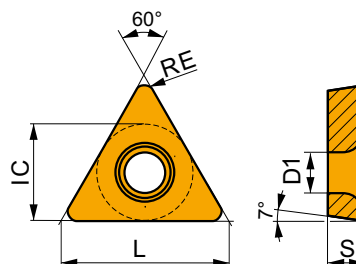

Idoneità e valori iniziali per velocità di taglio (Vc), avanzamento (f) e profondità di taglio (ap). Fare riferimento alla nostra App Machining Calculator per ulteriori calcoli.

Codice prodotto	RE (mm)	P			M			K			N			S			H		
		vc (m/min)	f (mm/rev)	ap (mm)	vc (m/min)	f (mm/rev)	ap (mm)	vc (m/min)	f (mm/rev)	ap (mm)	vc (m/min)	f (mm/rev)	ap (mm)	vc (m/min)	f (mm/rev)	ap (mm)	vc (m/min)	f (mm/rev)	ap (mm)



AL geometria con design altamente positivo per operazioni da finitura fino a sgrossatura, da taglio continuo a leggermente interrotto.

TCGT 090202F-AL	HF7	0.2	-	-	-	-	-	-	-	375	0.12	1.0	-	-	-	-	-	-
	T0315	0.2	-	-	-	-	-	-	-	555	0.12	1.0	-	-	-	-	-	-
TCGT 090204F-AL	HF7	0.4	-	-	-	-	-	-	-	300	0.24	1.0	-	-	-	-	-	-
	T0315	0.4	-	-	-	-	-	-	-	450	0.24	1.0	-	-	-	-	-	-
TCGT 110202F-AL	HF7	0.2	-	-	-	-	-	-	-	360	0.12	1.5	-	-	-	-	-	-
	T0315	0.2	-	-	-	-	-	-	-	525	0.12	1.5	-	-	-	-	-	-
TCGT 110204F-AL	HF7	0.4	-	-	-	-	-	-	-	285	0.24	1.5	-	-	-	-	-	-
	T0315	0.4	-	-	-	-	-	-	-	420	0.24	1.5	-	-	-	-	-	-
TCGT 110208F-AL	HF7	0.8	-	-	-	-	-	-	-	270	0.48	1.5	-	-	-	-	-	-
TCGT 16T304F-AL	HF7	0.4	-	-	-	-	-	-	-	285	0.24	2.4	-	-	-	-	-	-
	T0315	0.4	-	-	-	-	-	-	-	405	0.24	2.4	-	-	-	-	-	-
TCGT 16T308F-AL	HF7	0.8	-	-	-	-	-	-	-	255	0.48	2.4	-	-	-	-	-	-
	T0315	0.8	-	-	-	-	-	-	-	360	0.48	2.4	-	-	-	-	-	-

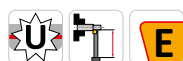
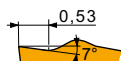

FF2 geometria positiva per operazioni da super finitura fino a finitura, da taglio continuo a leggermente interrotto.

TCGT 06T102E-FF2	T8330	0.2	175	0.05	0.8	-	-	-	165	0.05	0.8	-	-	-	-	-	-	-
	T8430	0.2	235	0.05	0.8	-	-	-	190	0.05	0.8	-	-	-	-	-	-	-
	TT010	0.2	295	0.05	0.5	-	-	-	-	-	-	-	-	-	-	-	-	-
TCGT 090202E-FF2	TT010	0.2	295	0.05	0.5	-	-	-	-	-	-	-	-	-	-	-	-	-

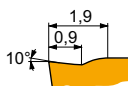
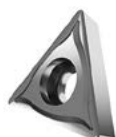

NF1 geometria con design positivo per operazioni da finitura fino a medie lavorazioni, taglio continuo.

TCGT 110204E-NF1	H07	0.4	-	-	-	80	0.09	0.8	-	415	0.12	0.8	40	0.08	0.6	-	-	-
	T6310	0.4	155	0.10	0.8	110	0.09	0.8	-	465	0.12	0.8	45	0.08	0.6	30	0.15	1.0
	T7325	0.4	180	0.10	0.8	140	0.09	0.8	-	-	-	-	55	0.08	0.6	-	-	-

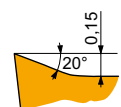

SF3 geometria con design altamente positivo per lavorazioni leggere e finitura, taglio continuo.

TCGT 110202E-SF3	T6310	0.2	175	0.05	0.8	125	0.05	0.8	140	0.05	0.8	525	0.06	0.8	50	0.04	0.6	35	0.15	1.0
	T8315	0.2	185	0.05	0.8	110	0.05	0.8	175	0.05	0.8	555	0.06	0.8	45	0.04	0.6	35	0.15	1.0
TCGT 110204E-SF3	H07	0.4	-	-	-	80	0.09	0.8	130	0.10	0.8	415	0.12	0.8	40	0.07	0.6	-	-	-
	T6310	0.4	155	0.10	0.8	110	0.09	0.8	125	0.10	0.8	465	0.12	0.8	45	0.07	0.6	30	0.15	1.0
	T8315	0.4	165	0.10	0.8	95	0.09	0.8	155	0.10	0.8	495	0.12	0.8	40	0.07	0.6	30	0.15	1.0



Idoneità e valori iniziali per velocità di taglio (Vc), avanzamento (f) e profondità di taglio (ap). Fare riferimento alla nostra App Machining Calculator per ulteriori calcoli.

Codice prodotto	RE (mm)	P			M			K			N			S			H		
		vc (m/min)	f (mm/rev)	ap (mm)	vc (m/min)	f (mm/rev)	ap (mm)	vc (m/min)	f (mm/rev)	ap (mm)	vc (m/min)	f (mm/rev)	ap (mm)	vc (m/min)	f (mm/rev)	ap (mm)	vc (m/min)	f (mm/rev)	ap (mm)

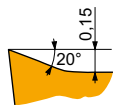

SF3 geometria con design altamente positivo per lavorazioni leggere e finitura, taglio continuo.

TCGT 16T304E-SF3	H07	0.4	–	–	–	80	0.09	1.0	125	0.10	1.0	405	0.12	1.0	40	0.07	0.8	–	–	–
	T6310	0.4	150	0.10	1.0	105	0.09	1.0	120	0.10	1.0	450	0.12	1.0	45	0.07	0.8	30	0.15	1.0
	T8315	0.4	160	0.10	1.0	95	0.09	1.0	150	0.10	1.0	480	0.12	1.0	40	0.07	0.8	30	0.15	1.0
TCGT 16T308E-SF3	H07	0.8	–	–	–	90	0.09	1.2	145	0.10	1.2	470	0.12	1.2	45	0.08	1.0	–	–	–
	T6310	0.8	175	0.10	1.2	125	0.09	1.2	140	0.10	1.2	525	0.12	1.2	50	0.08	1.0	35	0.15	1.0
	T8315	0.8	185	0.10	1.2	110	0.09	1.2	175	0.10	1.2	555	0.12	1.2	45	0.08	1.0	35	0.15	1.0
TCGT 16T312E-SF3	T6310	1.2	150	0.20	1.2	105	0.18	1.2	120	0.20	1.2	450	0.24	1.2	45	0.14	1.0	30	0.15	1.0

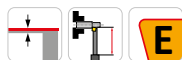

ER-SI geometria positiva destra per operazioni di finitura, taglio continuo.

TCGT 110202ER-SI	T8315	0.2	190	0.10	0.8	110	0.09	0.8	180	0.10	0.8	–	–	–	45	0.08	0.6	–	–	–
	T8330	0.2	180	0.10	0.8	105	0.09	0.8	170	0.10	0.8	–	–	–	45	0.08	0.6	–	–	–
	T8430	0.2	225	0.10	0.8	120	0.09	0.8	185	0.10	0.8	–	–	–	45	0.08	0.6	–	–	–
TCGT 110204ER-SI	T8330	0.4	180	0.12	0.8	105	0.11	0.8	170	0.12	0.8	–	–	–	45	0.10	0.6	–	–	–
	T8430	0.4	225	0.12	0.8	120	0.11	0.8	185	0.12	0.8	–	–	–	45	0.10	0.6	–	–	–



EL-SI geometria positiva sinistra per operazioni da finitura, taglio continuo.

TCGT 110202EL-SI	T8315	0.2	190	0.10	0.8	110	0.09	0.8	180	0.10	0.8	–	–	–	45	0.08	0.6	–	–	–
	T8330	0.2	180	0.10	0.8	105	0.09	0.8	170	0.10	0.8	–	–	–	45	0.08	0.6	–	–	–
	T8430	0.2	225	0.10	0.8	120	0.09	0.8	185	0.10	0.8	–	–	–	45	0.08	0.6	–	–	–
TCGT 110204EL-SI	T8315	0.4	195	0.12	0.8	115	0.11	0.8	185	0.12	0.8	–	–	–	45	0.10	0.6	–	–	–
	T8330	0.4	180	0.12	0.8	105	0.11	0.8	170	0.12	0.8	–	–	–	45	0.10	0.6	–	–	–
	T8430	0.4	225	0.12	0.8	120	0.11	0.8	185	0.12	0.8	–	–	–	45	0.10	0.6	–	–	–

TCMT



	IC (mm)	D1 (mm)	L (mm)	S (mm)
06T1	3.970	2.20	6.90	1.98
0902	5.560	2.50	9.60	2.38
1102	6.350	2.80	11.00	2.38
16T3	9.525	4.40	16.50	3.97

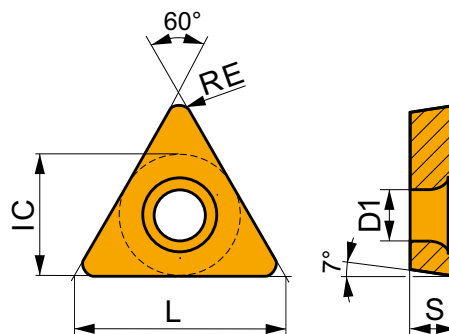

Idoneità e valori iniziali per velocità di taglio (Vc), avanzamento (f) e profondità di taglio (ap). Fare riferimento alla nostra App Machining Calculator per ulteriori calcoli.

Codice prodotto	RE (mm)	P			M			K			N			S			H		
		vc (m/min)	f (mm/rev)	ap (mm)	vc (m/min)	f (mm/rev)	ap (mm)	vc (m/min)	f (mm/rev)	ap (mm)	vc (m/min)	f (mm/rev)	ap (mm)	vc (m/min)	f (mm/rev)	ap (mm)	vc (m/min)	f (mm/rev)	ap (mm)

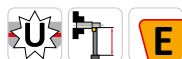
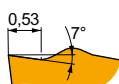

FF2 geometria positiva per operazioni da super finitura fino a finitura, da taglio continuo a leggermente interrotto.

TCMT 06T102E-FF2	T8330	0.2	175	0.05	0.8	–	–	–	165	0.05	0.8	–	–	–	–	–	–	–	–	–
	T8430	0.2	235	0.05	0.8	–	–	–	190	0.05	0.8	–	–	–	–	–	–	–	–	–
	T9315	0.2	335	0.05	0.8	–	–	–	315	0.05	0.8	–	–	–	–	–	–	–	–	–



Idoneità e valori iniziali per velocità di taglio (Vc), avanzamento (f) e profondità di taglio (ap). Fare riferimento alla nostra App Machining Calculator per ulteriori calcoli.

Codice prodotto	RE  (mm)	P			M			K			N			S			H		
		vc (m/min)	f (mm/rev)	ap (mm)	vc (m/min)	f (mm/rev)	ap (mm)	vc (m/min)	f (mm/rev)	ap (mm)	vc (m/min)	f (mm/rev)	ap (mm)	vc (m/min)	f (mm/rev)	ap (mm)	vc (m/min)	f (mm/rev)	ap (mm)

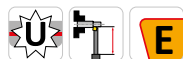
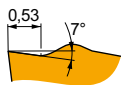

FF2 geometria positiva per operazioni da super finitura fino a finitura, da taglio continuo a leggermente interrotto.

TCMT 06T104E-FF2	T7325	0.4	✓	170	0.12	0.8													
	T8330	0.4	■	145	0.12	0.8				■	135	0.12	0.8						
	T8430	0.4	■	180	0.12	0.8				✓	145	0.12	0.8						
	T9315	0.4	■	245	0.12	0.8				✓	230	0.12	0.8						
	T9325	0.4	■	220	0.12	0.8				✓	205	0.12	0.8						
TCMT 090204E-FF2	T5315	0.4	✓	240	0.12	1.0				■	225	0.12	1.0						
	T7325	0.4	✓	165	0.12	1.0													
	T8330	0.4	■	140	0.12	1.0				■	130	0.12	1.0						
	T8430	0.4	■	175	0.12	1.0				✓	140	0.12	1.0						
	T9315	0.4	■	240	0.12	1.0				✓	225	0.12	1.0						
TCMT 110204E-FF2	T7325	0.4	✓	170	0.12	0.8													
	T8330	0.4	■	145	0.12	0.8				■	135	0.12	0.8						
	T8430	0.4	■	180	0.12	0.8				✓	145	0.12	0.8						
	T9315	0.4	■	245	0.12	0.8				✓	230	0.12	0.8						
	T9325	0.4	■	220	0.12	0.8				✓	205	0.12	0.8						
TCMT 110208E-FF2	T7325	0.8	✓	180	0.17	0.8													
	T8330	0.8	■	155	0.17	0.8				■	145	0.17	0.8						
	T8430	0.8	■	185	0.17	0.8				✓	150	0.17	0.8						
	T9315	0.8	■	250	0.17	0.8				✓	235	0.17	0.8						
	T9325	0.8	■	225	0.17	0.8				✓	210	0.17	0.8						
TCMT 16T304E-FF2	T7325	0.4	✓	170	0.12	0.8													
	T8330	0.4	■	145	0.12	0.8				■	135	0.12	0.8						
	T8430	0.4	■	180	0.12	0.8				✓	145	0.12	0.8						
	T9315	0.4	■	245	0.12	0.8				✓	230	0.12	0.8						
	T9325	0.4	■	220	0.12	0.8				✓	205	0.12	0.8						
	T9335	0.4	■	185	0.12	0.8													
TCMT 16T308E-FF2	TT010	0.4	■	295	0.06	0.5													
	T7325	0.8	✓	180	0.17	0.8													
	T8330	0.8	■	155	0.17	0.8				■	145	0.17	0.8						
	T8430	0.8	■	185	0.17	0.8				✓	150	0.17	0.8						
	T9315	0.8	■	250	0.17	0.8				✓	235	0.17	0.8						
	T9325	0.8	■	225	0.17	0.8				✓	210	0.17	0.8						

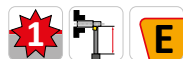

FM geometria per operazioni da finitura fino a semi sgrassatura, da taglio continuo a leggermente interrotto.

TCMT 110202E-FM	T7325	0.2	✓	185	0.10	0.8	■	140	0.09	0.8										
	T7335	0.2	✓	185	0.10	0.8	■	140	0.09	0.8										
	T8315	0.2	✓	170	0.10	0.8	■	100	0.09	0.8	✓	160	0.10	0.8	✓	510	0.12	0.8		
	T8330	0.2	■	160	0.10	0.8	■	95	0.09	0.8	✓	150	0.10	0.8	✓	480	0.12	0.8		
	T8430	0.2	■	195	0.10	0.8	■	105	0.09	0.8	✓	160	0.10	0.8	✓	540	0.12	0.8		
	T9315	0.2	■	270	0.10	0.8					✓	255	0.10	0.8						
TCMT 110204E-FM	T9325	0.2	■	245	0.10	0.8	■	145	0.09	0.8	✓	230	0.10	0.8						
	T7325	0.4	✓	160	0.19	0.8	■	120	0.17	0.8										
	T7335	0.4	✓	155	0.19	0.8	■	120	0.17	0.8										
	T8315	0.4	✓	170	0.12	0.8	■	100	0.11	0.8	✓	160	0.12	0.8	✓	510	0.14	0.8		
	T8330	0.4	■	160	0.12	0.8	■	95	0.11	0.8	✓	150	0.12	0.8	✓	480	0.14	0.8		
	T8430	0.4	■	195	0.12	0.8	■	105	0.11	0.8	✓	160	0.12	0.8	✓	540	0.14	0.8		
	T9315	0.4	■	270	0.12	0.8				✓	255	0.12	0.8							
	T9325	0.4	■	205	0.18	0.8	■	120	0.16	0.8	✓	190	0.18	0.8						



Idoneità e valori iniziali per velocità di taglio (Vc), avanzamento (f) e profondità di taglio (ap). Fare riferimento alla nostra App Machining Calculator per ulteriori calcoli.

Codice prodotto	RE (mm)	P			M			K			N			S			H		
		vc (m/min)	f (mm/rev)	ap (mm)	vc (m/min)	f (mm/rev)	ap (mm)	vc (m/min)	f (mm/rev)	ap (mm)	vc (m/min)	f (mm/rev)	ap (mm)	vc (m/min)	f (mm/rev)	ap (mm)	vc (m/min)	f (mm/rev)	ap (mm)

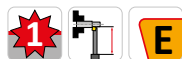
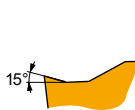

FM geometria per operazioni da finitura fino a semi sgrossatura, da taglio continuo a leggermente interrotto.

TCMT 110208E-FM	T7325	0.8	195	0.17	0.8	150	0.15	0.8	-	-	-	-	-	-	-	-	-	-
	T8330	0.8	175	0.17	0.8	105	0.15	0.8	165	0.17	0.8	525	0.20	0.8	-	-	-	-
	T8430	0.8	200	0.17	0.8	110	0.15	0.8	165	0.17	0.8	555	0.20	0.8	-	-	-	-
	T9315	0.8	275	0.17	0.8	-	-	-	260	0.17	0.8	-	-	-	-	-	-	-
	T9325	0.8	250	0.17	0.8	150	0.15	0.8	235	0.17	0.8	-	-	-	-	-	-	-
TCMT 16T304E-FM	T7325	0.4	150	0.19	1.7	115	0.17	1.7	-	-	-	-	-	-	-	-	-	-
	T7335	0.4	145	0.19	1.7	110	0.17	1.7	-	-	-	-	-	-	-	-	-	-
	T8315	0.4	155	0.12	1.7	90	0.11	1.7	145	0.12	1.7	465	0.14	1.7	-	-	-	-
	T8330	0.4	150	0.12	1.7	90	0.11	1.7	140	0.12	1.7	450	0.14	1.7	-	-	-	-
	T8430	0.4	180	0.12	1.7	95	0.11	1.7	145	0.12	1.7	495	0.14	1.7	-	-	-	-
	T9315	0.4	250	0.12	1.7	-	-	-	235	0.12	1.7	-	-	-	-	-	-	-
	T9325	0.4	190	0.18	1.7	110	0.16	1.7	180	0.18	1.7	-	-	-	-	-	-	-
TCMT 16T308E-FM	T7325	0.8	180	0.17	1.7	140	0.15	1.7	-	-	-	-	-	-	-	-	-	-
	T7335	0.8	175	0.17	1.7	135	0.15	1.7	-	-	-	-	-	-	-	-	-	-
	T8315	0.8	170	0.17	1.7	100	0.15	1.7	160	0.17	1.7	510	0.20	1.7	-	-	-	-
	T8330	0.8	160	0.17	1.7	95	0.15	1.7	150	0.17	1.7	480	0.20	1.7	-	-	-	-
	T8430	0.8	185	0.17	1.7	100	0.15	1.7	150	0.17	1.7	510	0.20	1.7	-	-	-	-
	T9315	0.8	255	0.17	1.7	-	-	-	240	0.17	1.7	-	-	-	-	-	-	-
	T9325	0.8	230	0.17	1.7	135	0.15	1.7	215	0.17	1.7	-	-	-	-	-	-	-

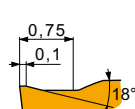

FM2 geometria per operazioni da finitura fino a lavorazioni medie, da taglio continuo a interrotto.

TCMT 110204E-FM2	T8330	0.4	145	0.12	0.8	85	0.11	0.8	135	0.12	0.8	-	-	-	-	-	-
	T8430	0.4	180	0.12	0.8	95	0.11	0.8	145	0.12	0.8	-	-	-	-	-	-
	T9325	0.4	220	0.12	0.8	130	0.11	0.8	205	0.12	0.8	-	-	-	-	-	-
TCMT 110208E-FM2	T8330	0.8	155	0.17	0.8	90	0.15	0.8	145	0.17	0.8	-	-	-	-	-	-
	T8430	0.8	185	0.17	0.8	100	0.15	0.8	150	0.17	0.8	-	-	-	-	-	-
	T9325	0.8	225	0.17	0.8	135	0.15	0.8	210	0.17	0.8	-	-	-	-	-	-
	T9335	0.8	195	0.17	0.8	115	0.15	0.8	-	-	-	-	-	-	-	-	-
TCMT 16T308E-FM2	T7325	0.8	170	0.20	1.0	130	0.18	1.0	-	-	-	-	-	-	-	-	-
	T8330	0.8	145	0.20	1.0	85	0.18	1.0	135	0.20	1.0	-	-	-	-	-	-
	T8430	0.8	170	0.20	1.0	90	0.18	1.0	135	0.20	1.0	-	-	-	-	-	-
	T9325	0.8	205	0.20	1.0	120	0.18	1.0	190	0.20	1.0	-	-	-	-	-	-
	T9335	0.8	175	0.20	1.0	105	0.18	1.0	-	-	-	-	-	-	-	-	-

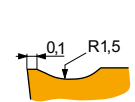

RF geometria per operazioni da semi sgrossatura fino a sgrossatura, da taglio continuo a interrotto.

TCMT 16T308E-RF	T9325	0.8	175	0.20	1.5	105	0.18	1.5	165	0.20	1.5	-	-	-	-	-	-
-----------------	-------	-----	-----	------	-----	-----	------	-----	-----	------	-----	---	---	---	---	---	---

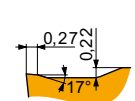

RM geometria per operazioni da semi sgrossatura fino a sgrossatura, da taglio continuo a interrotto.

TCMT 16T308E-RM	T5305	0.8	265	0.27	1.9	-	-	-	250	0.27	1.9	-	-	-	50	0.15	1.0
	T5315	0.8	235	0.27	1.9	-	-	-	220	0.27	1.9	-	-	-	45	0.15	1.0
	T7335	0.8	155	0.27	1.9	120	0.24	1.9	-	-	-	50	0.19	1.5	-	-	
	T8330	0.8	145	0.27	1.9	85	0.24	1.9	135	0.27	1.9	-	-	-	35	0.19	1.5
	T8430	0.8	165	0.27	1.9	90	0.24	1.9	135	0.27	1.9	-	-	-	35	0.19	1.5
	T9315	0.8	215	0.27	1.9	-	-	-	200	0.27	1.9	-	-	-	40	0.15	1.0
	T9325	0.8	195	0.27	1.9	115	0.24	1.9	185	0.27	1.9	-	-	-	40	0.19	1.5



Idoneità e valori iniziali per velocità di taglio (Vc), avanzamento (f) e profondità di taglio (ap). Fare riferimento alla nostra App Machining Calculator per ulteriori calcoli.

Codice prodotto	RE  (mm)	P			M			K			N			S			H		
		vc (m/min)	f (mm/rev)	ap (mm)	vc (m/min)	f (mm/rev)	ap (mm)	vc (m/min)	f (mm/rev)	ap (mm)	vc (m/min)	f (mm/rev)	ap (mm)	vc (m/min)	f (mm/rev)	ap (mm)	vc (m/min)	f (mm/rev)	ap (mm)

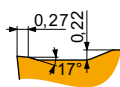

RM geometria per operazioni da semi sgrossatura fino a sgrossatura, da taglio continuo a interrotto.

TCMT 16T312E-RM	T5305	1.2	280	0.27	1.9	-	-	-	265	0.27	1.9	-	-	-	-	-	55	0.15	1.0	
	T5315	1.2	250	0.27	1.9	-	-	-	235	0.27	1.9	-	-	-	-	-	50	0.15	1.0	
	T8330	1.2	150	0.27	1.9	90	0.24	1.9	140	0.27	1.9	-	-	-	35	0.19	1.5	30	0.15	1.0
	T8430	1.2	170	0.27	1.9	90	0.24	1.9	135	0.27	1.9	-	-	-	35	0.19	1.5	25	0.15	1.0
	T9315	1.2	225	0.27	1.9	-	-	-	210	0.27	1.9	-	-	-	-	-	45	0.15	1.0	
	T9325	1.2	205	0.27	1.9	120	0.24	1.9	190	0.27	1.9	-	-	-	45	0.19	1.5	-	-	-

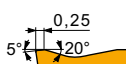

RM3 geometria per operazioni da semi sgrossatura fino a sgrossatura, da taglio continuo a interrotto.

TCMT 16T304E-RM3	T6310	0.4	110	0.25	2.0	75	0.25	2.0	85	0.25	2.0	-	-	-	-	-	20	0.15	1.0
	T7325	0.4	125	0.25	2.0	95	0.25	2.0	-	-	-	-	-	-	-	-	-	-	-
	T8330	0.4	110	0.25	2.0	65	0.25	2.0	100	0.25	2.0	-	-	-	-	-	20	0.15	1.0
	T8430	0.4	120	0.25	2.0	65	0.25	2.0	95	0.25	2.0	-	-	-	-	-	20	0.15	1.0
	T9315	0.4	165	0.25	2.0	-	-	-	155	0.25	2.0	-	-	-	-	-	30	0.15	1.0
	T9325	0.4	145	0.25	2.0	85	0.25	2.0	135	0.25	2.0	-	-	-	-	-	-	-	-
TCMT 16T308E-RM3	T9335	0.4	125	0.25	2.0	75	0.25	2.0	-	-	-	-	-	-	-	-	-	-	-
	T6310	0.8	125	0.27	2.0	90	0.27	2.0	100	0.27	2.0	-	-	-	-	-	25	0.15	1.0
	T7325	0.8	145	0.27	2.0	110	0.27	2.0	-	-	-	-	-	-	-	-	-	-	-
	T8330	0.8	125	0.27	2.0	75	0.27	2.0	115	0.27	2.0	-	-	-	-	-	25	0.15	1.0
	T8430	0.8	135	0.27	2.0	75	0.27	2.0	110	0.27	2.0	-	-	-	-	-	20	0.15	1.0
	T9315	0.8	185	0.27	2.0	-	-	-	175	0.27	2.0	-	-	-	-	-	35	0.15	1.0
	T9325	0.8	170	0.27	2.0	100	0.27	2.0	160	0.27	2.0	-	-	-	-	-	-	-	-
	T9335	0.8	145	0.27	2.0	85	0.27	2.0	-	-	-	-	-	-	-	-	-	-	-

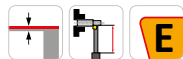
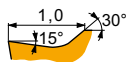

UR geometria per lavorazioni leggere e finitura, da taglio continuo a leggermente interrotto.

TCMT 110204E-UR	T7325	0.4	135	0.19	0.8	105	0.17	0.8	-	-	-	-	-	-	-	-	-	-	-
	T8330	0.4	135	0.12	0.8	80	0.11	0.8	125	0.12	0.8	-	-	-	-	-	-	-	-
	T8430	0.4	170	0.12	0.8	90	0.11	0.8	135	0.12	0.8	-	-	-	-	-	-	-	-
	T9315	0.4	235	0.12	0.8	-	-	-	220	0.12	0.8	-	-	-	-	-	-	-	-
	T9325	0.4	175	0.18	0.8	105	0.16	0.8	165	0.18	0.8	-	-	-	-	-	-	-	-
TCMT 16T304E-UR	T7325	0.4	135	0.19	0.8	105	0.17	0.8	-	-	-	-	-	-	-	-	-	-	-
	T8330	0.4	135	0.12	0.8	80	0.11	0.8	125	0.12	0.8	-	-	-	-	-	-	-	-
	T8430	0.4	170	0.12	0.8	90	0.11	0.8	135	0.12	0.8	-	-	-	-	-	-	-	-
	T9315	0.4	235	0.12	0.8	-	-	-	220	0.12	0.8	-	-	-	-	-	-	-	-
	T9325	0.4	175	0.18	0.8	105	0.16	0.8	165	0.18	0.8	-	-	-	-	-	-	-	-
	TT310	0.4	225	0.12	0.8	135	0.11	0.8	-	-	-	-	-	-	-	-	-	-	-
TCMT 16T308E-UR	T5315	0.8	245	0.17	0.8	-	-	-	230	0.17	0.8	-	-	-	-	-	-	-	-
	T7325	0.8	170	0.17	0.8	130	0.15	0.8	-	-	-	-	-	-	-	-	-	-	
	T8330	0.8	150	0.17	0.8	90	0.15	0.8	140	0.17	0.8	-	-	-	-	-	-	-	
	T8430	0.8	175	0.17	0.8	95	0.15	0.8	140	0.17	0.8	-	-	-	-	-	-	-	
	T9315	0.8	240	0.17	0.8	-	-	-	225	0.17	0.8	-	-	-	-	-	-	-	-
	T9325	0.8	215	0.17	0.8	125	0.15	0.8	200	0.17	0.8	-	-	-	-	-	-	-	-



TCMW



	IC	D1	L	S
	(mm)	(mm)	(mm)	(mm)
1102	6.350	2.80	11.00	2.38
16T3	9.525	4.40	16.50	3.97

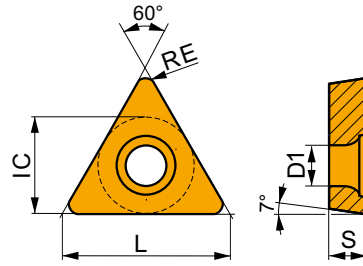

Idoneità e valori iniziali per velocità di taglio (Vc), avanzamento (f) e profondità di taglio (ap). Fare riferimento alla nostra App Machining Calculator per ulteriori calcoli.

Codice prodotto	RE	P			M			K			N			S			H		
		vc	f	ap	vc	f	ap	vc	f	ap	vc	f	ap	vc	f	ap	vc	f	ap
	(mm)	(m/min)	(mm/rev)	(mm)	(m/min)	(mm/rev)	(mm)	(m/min)	(mm/rev)	(mm)	(m/min)	(mm/rev)	(mm)	(m/min)	(mm/rev)	(mm)	(m/min)	(mm/rev)	(mm)

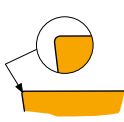

Adatta per operazioni di finitura fino a semi sgrossatura, da taglio continuo a leggermente interrotto.

TCMW 110204	T5305	0.4	–	–	–	–	–	–	200	0.10	1.2	–	–	–	–	–	–	40	0.15	1.0
	T5315	0.4	–	–	–	–	–	–	180	0.10	1.2	–	–	–	–	–	–	35	0.15	1.0
TCMW 16T304	T5305	0.4	–	–	–	–	–	–	195	0.10	1.5	–	–	–	–	–	–	40	0.15	1.0
	T5315	0.4	–	–	–	–	–	–	175	0.10	1.5	–	–	–	–	–	–	35	0.15	1.0
	T6310	0.4	–	–	–	–	–	–	85	0.10	1.5	–	–	–	–	–	–	20	0.15	1.0
TCMW 16T308	T5305	0.8	–	–	–	–	–	–	190	0.18	1.5	–	–	–	–	–	–	40	0.15	1.0
	T5315	0.8	–	–	–	–	–	–	165	0.18	1.5	–	–	–	–	–	–	35	0.15	1.0
	T6310	0.8	–	–	–	–	–	–	85	0.18	1.5	–	–	–	–	–	–	20	0.15	1.0

TCGW CBN



	IC	D1	L	S
	(mm)	(mm)	(mm)	(mm)
1102	6.350	2.90	11.00	2.38

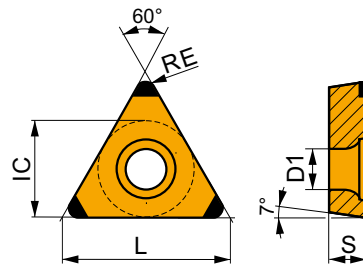

Idoneità e valori iniziali per velocità di taglio (Vc), avanzamento (f) e profondità di taglio (ap). Fare riferimento alla nostra App Machining Calculator per ulteriori calcoli.

Codice prodotto	RE	P			M			K			N			S			H		
		vc	f	ap	vc	f	ap	vc	f	ap	vc	f	ap	vc	f	ap	vc	f	ap
	(mm)	(m/min)	(mm/rev)	(mm)	(m/min)	(mm/rev)	(mm)	(m/min)	(mm/rev)	(mm)	(m/min)	(mm/rev)	(mm)	(m/min)	(mm/rev)	(mm)	(m/min)	(mm/rev)	(mm)

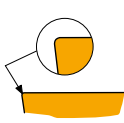

Adatta per operazioni di finitura e taglio continuo.

TCGW 110204E-C	TB310	0.4	–	–	–	–	–	–	390	0.10	0.4	–	–	–	100	0.07	0.3	80	0.15	1.0
-----------------------	--------------	-----	---	---	---	---	---	---	-----	------	-----	---	---	---	-----	------	-----	----	------	-----

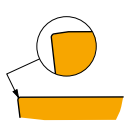

Adatta per operazioni di finitura e taglio continuo.

TCGW 110204S01020C	TB310	0.4	–	–	–	–	–	–	390	0.10	0.4	–	–	–	100	0.07	0.3	80	0.15	1.0
TCGW 110208S01020C	TB310	0.8	–	–	–	–	–	–	400	0.15	0.6	–	–	–	105	0.11	0.5	85	0.15	1.0



STFC(RL) EXT



PRAMET

S



Utensile esterno, bloccaggio a vite, inserti TC... angolo del tagliente utensile 91° (sfacciatura)

Utensile di tornitura esterna destro/sinistro con bloccaggio a vite, angolo del tagliente utensile 91° per inserti positivi TC...11 e 16. Adatto per operazioni di sfacciatura con spallamento e smussi. Disponibile con stelo da 16x16 a 25x25 mm. Corpo trattato per una maggiore durata.

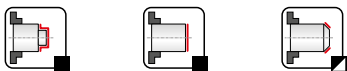
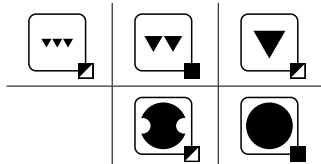
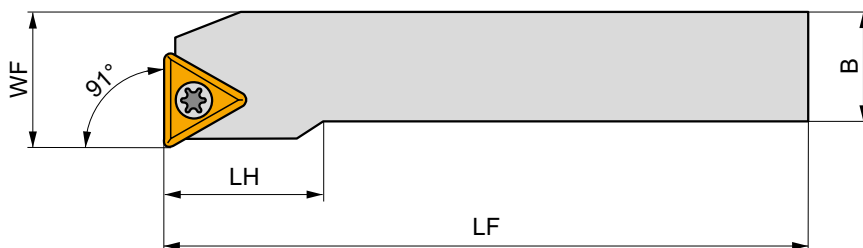
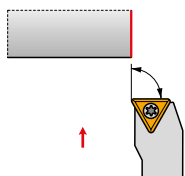

Codice prodotto	H	B	HF	WF	LF	LH	LAMS	GAMO	kg	GI	ST	
	(mm)	(mm)	(mm)	(mm)	(mm)	(mm)	(°)	(°)				
R	STFCR 1616 H 11	16	16	16	20	100	18	0	0	0.20	GI056	S01
	STFCR 2020 K 16-M-A	20	20	20	25	125	25	0	0	0.40	GI016	ST10
	STFCR 2525 M 16-M-A	25	25	25	32	150	25	0	0	0.76	GI016	ST10
L	STFCL 1616 H 11	16	16	16	20	100	18	0	0	0.22	GI056	S01
	STFCL 2020 K 16-M-A	20	20	20	25	125	25	0	0	0.40	GI016	ST10
	STFCL 2525 M 16-M-A	25	25	25	32	150	25	0	0	0.75	GI016	ST10



GI016
GI056

TC.. 16T3..
TC.. 1102..



S01	US 2506-T07P	0.9	M 2.5	6.3	-	-	FLAGT07P	-
ST10	US 3510-T15P	3.0	M 3.5	10.6	STN 160308	MS 3510	FLAGT15P	HXK 3.5



STFC(RL)-A EXT

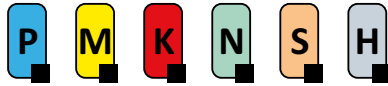

PRAMET

S



Utensile esterno, bloccaggio a vite, inserti TC... angolo del tagliente utensile 90° (sfacciatura)

Utensile di tornitura esterna destro/sinistro con bloccaggio a vite, angolo del tagliente utensile 90° per inserto positivo TC...11. Adatto per operazioni di sfacciatura su doppio lato con spallamento e smussi. Disponibile con stelo 20x20 mm. Corpo trattato per una maggiore durata.

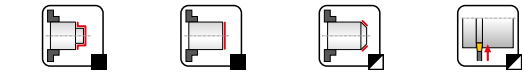
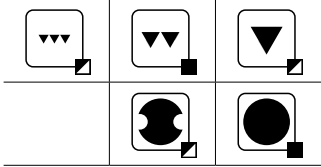
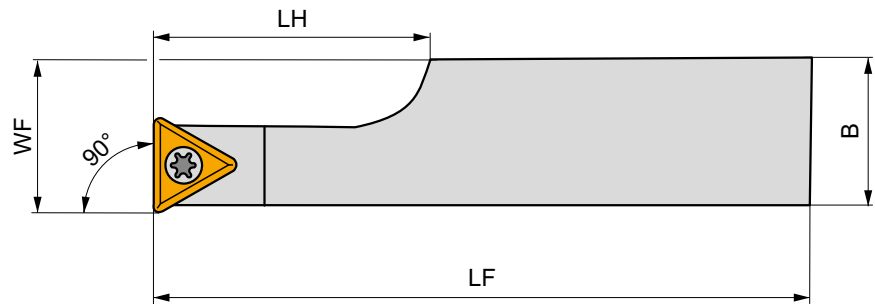
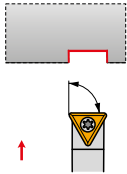

Codice prodotto	H	B	HF	WF	LF	LH	LAMS	GAMO	kg		
	(mm)	(mm)	(mm)	(mm)	(mm)	(mm)	(°)	(°)			
R STFCR 2020 K 11-A	20	20	20	25	125	21.3	0	0	0.52	G1056	ST21
L STFCL 2020 K 11-A	20	20	20	25	125	21.3	0	0	0.36	G1056	ST21

G1056	TC.. 1102..

ST21	5513 020-03	0.8	M 2.5	6.5	PT-8001



STJC(RL) EXT



PRAMET



Utensile esterno, bloccaggio a vite, inserti TC... angolo del tagliente utensile 93°

Utensile di tornitura esterna destro/sinistro con bloccaggio a vite, angolo del tagliente utensile 93° per inserti positivi TC...11 e 16. Adatto per operazioni di tornitura longitudinale con spallamento, conicità e smussi. Disponibile con stelo da 16x16 a 25x25 mm. Corpo trattato per una maggiore durata.

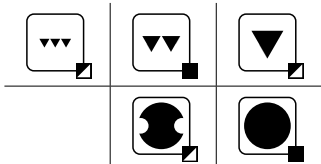
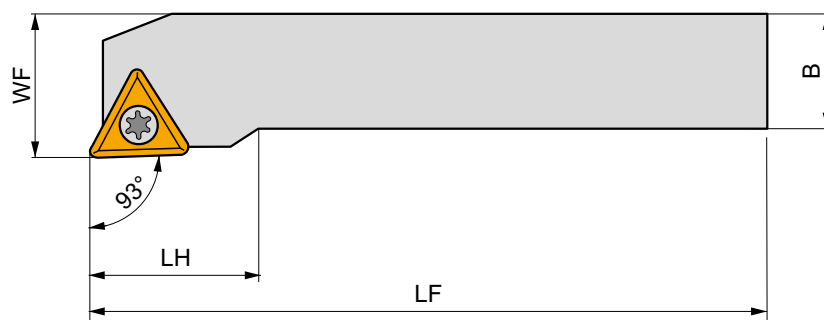
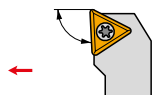

Codice prodotto	H (mm)	B (mm)	HF (mm)	WF (mm)	LF (mm)	LH (mm)	LAMS (°)	GAMO (°)	kg	GI	ST
R STJCR 1616 H 11	16	16	16	20	100	18	0	0	0.23	GI056	S01
STJCR 2020 K 16-M-A	20	20	20	25	125	25	0	0	0.44	GI016	ST10
STJCR 2525 M 16-M-A	25	25	25	32	150	25	0	0	0.76	GI016	ST10
L STJCL 1616 H 11	16	16	16	20	100	18	0	0	0.22	GI056	S01
STJCL 2020 K 16-M-A	20	20	20	25	125	25	0	0	0.43	GI016	ST10
STJCL 2525 M 16-M-A	25	25	25	32	150	25	0	0	0.75	GI016	ST10

GI	TC
GI016	TC.. 16T3..
GI056	TC.. 1102..

ST	US	Nm	M	mm	STN	MS	FLAG	HXK
S01	US 2506-T07P	0.9	M 2.5	6.3	-	-	FLAGT07P	-
ST10	US 3510-T15P	3.0	M 3.5	10.6	STN 160308	MS 3510	FLAGT15P	HXK 3.5



STFC(RL) INT

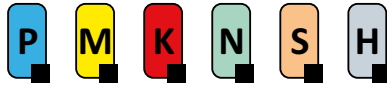

PRAMET

S



Utensile interno, bloccaggio a vite, inserti TC... angolo del tagliente utensile 91°

Bareno destro/sinistro per tornitura interna con bloccaggio a vite e passaggio refrigerante interno, angolo del tagliente utensile 91° per inserti positivi da TC...06 a 16. Diametro interno minimo tornibile Ø8.5 mm. Adatto per operazioni di tornitura longitudinale, spallamento, conicità e smussi. Disponibile con stelo da Ø6 mm a Ø32 mm. Corpo trattato per una maggiore durata.

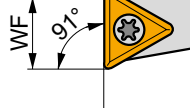
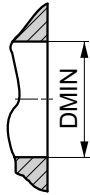
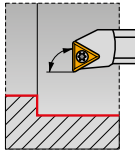

LF

DCON MS

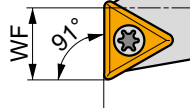
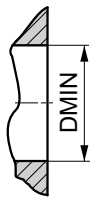
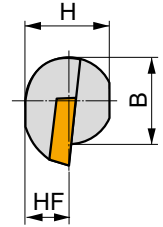

LF

DCON MS

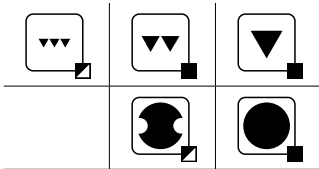
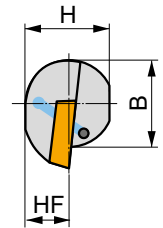

Codice prodotto	DCON MS	DMIN	WF	H	B	LF	LAMS	GAMO				
	(mm)	(mm)	(mm)	(mm)	(mm)	(mm)	(°)	(°)				
R A06F-STFCR 06	6	8.5	4.5	5	-	80	-12	0	✓	0.03	G1217	ST12
A08H-STFCR 06	8	11	5.9	7	-	100	-10	0	✓	0.04	G1217	ST13
A10K-STFCR 09	10	13	7	9	-	125	-9	0	✓	0.06	G1218	ST14
A12M-STFCR 09	12	16	9	11	-	150	-6.5	0	✓	0.12	G1218	ST14
S10H-STFCR 11	10	13	7	9	9.5	100	-10	0	-	0.08	GI056	S02
A12M-STFCR 11	12	16	9	11	11.5	150	-10	0	✓	0.14	GI056	S01
S12K-STFCR 11	12	16	9	11	11.5	125	-7	0	-	0.13	GI056	S01
A16R-STFCR 11	16	20	11	14.5	15	200	-7	0	✓	0.27	GI056	S01
S16M-STFCR 11	16	20	11	14.5	15	150	-7	0	-	0.24	GI056	S01
A20S-STFCR 11	20	25	13	18	18.5	250	-7	0	✓	0.54	GI056	S01
S20Q-STFCR 11	20	25	13	18	18.5	180	-7	0	-	0.40	GI056	S01
A25R-STFCR 16	25	32	17	23	23	200	-3	0	✓	0.67	GI016	S08
S25T-STFCR 16	25	32	17	23	23	300	-3	0	-	1.15	GI016	S08
A32S-STFCR 16	32	40	22	30	30	250	-10	0	✓	1.36	GI016	ST10
S32U-STFCR 16-A	32	40	22	30	30	350	-10	0	-	2.10	GI016	ST10
L A06F-STFCL 06	6	8.5	4.5	5	-	80	-12	0	✓	0.03	G1217	ST12
A08H-STFCL 06	8	11	5.9	7	-	100	-10	0	✓	0.05	G1217	ST13
A10K-STFCL 09	10	13	7	9	-	125	-9	0	✓	0.06	G1218	ST14
A12M-STFCL 09	12	16	9	11	-	150	-6.5	0	✓	0.03	G1218	ST14
S10H-STFCL 11	10	13	7	9	9.5	100	-10	0	-	0.06	GI056	S02
A12M-STFCL 11	12	16	9	11	11.5	150	-10	0	✓	0.12	GI056	S01
S12K-STFCL 11	12	16	9	11	11.5	125	-7	0	-	0.12	GI056	S01
A16R-STFCL 11	16	20	11	14.5	15	200	-7	0	✓	0.00	GI056	S01
S16M-STFCL 11	16	20	11	14.5	15	150	-7	0	-	0.25	GI056	S01
A20S-STFCL 11	20	25	13	18	18.5	250	-7	0	✓	0.00	GI056	S01
S20Q-STFCL 11	20	25	13	18	18.5	180	-7	0	-	0.42	GI056	S01
A25R-STFCL 16	25	32	17	23	23	200	-3	0	✓	0.00	GI016	S08



Codice prodotto	DCON MS	DMIN	WF	H	B	LF	LAMS	GAMO				
	(mm)	(mm)	(mm)	(mm)	(mm)	(mm)	(°)	(°)				
L S25T-STFCL 16	25	32	17	23	23	300	-3	0	-	1.15	GI016	S08
A32S-STFCL 16	32	40	22	30	30	250	-10	0	✓	1.36	GI016	ST10
S32U-STFCL 16-A	32	40	22	30	30	350	-10	0	-	2.06	GI016	ST10

GI016	TC.. 16T3..
GI056	TC.. 1102..
GI217	TC.. 06T1..
GI218	TC.. 0902..

S01	US 2506-T07P	0.9	M 2.5	6.3	-	-	FLAG T07P	-	-
S02	US 2505-T07P	0.9	M 2.5	5.2	-	-	FLAG T07P	-	-
S08	US 3510-T15P	3.0	M 3.5	10.6	-	-	FLAG T15P	-	-
ST10	US 3510-T15P	3.0	M 3.5	10.6	STN 160308	MS 3510	FLAG T15P	HXK 3.5	-
ST12	5513 020-28	0.6	M 2	4.2	-	-	-	-	PT-8000
ST13	5513 020-27	0.6	M 2	4.9	-	-	-	-	PT-8000
ST14	5513 020-05	0.8	M 2.2	6.4	-	-	-	-	PT-8001



STFC(RL)-E INT

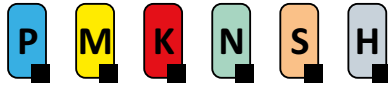

PRAMET

S



Utensile interno in metallo duro, bloccaggio a vite, per inserto TC... angolo del tagliente utensile 91°

Bareno destro/sinistro in metallo duro per tornitura interna con bloccaggio a vite e passaggio refrigerante interno, angolo del tagliente utensile 91° per inserti positivi TC...06, 09 e 11. Diametro interno minimo tornibile Ø8.5 mm. Adatto per operazioni di tornitura longitudinale, spallamento, conicità e smussi. Disponibile con stelo da Ø6 mm a Ø16 mm. Per sporgenze utensile >3xD.

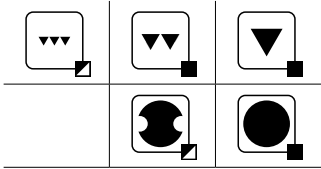
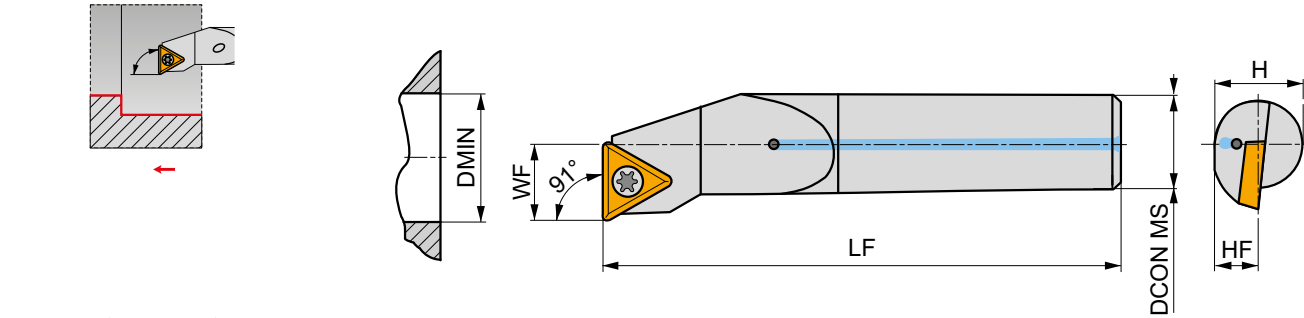

Codice prodotto	DCON MS (mm)	DMIN (mm)	WF (mm)	H (mm)	HF (mm)	LF (mm)	LAMS (°)	GAMO (°)		kg		
R E06H-STFCR 06-R	6	8.5	4.5	6	3	100	-10	0	✓	0.05	GI217	ST22
E08K-STFCR 06-R	8	11	5.9	8	4	125	-10	0	✓	0.09	GI217	ST23
E10M-STFCR 09-R	10	13	7	10	5	150	-8	0	✓	0.15	GI218	ST24
E12Q-STFCR 09-R	12	16	9	12	6	180	-6	0	✓	0.26	GI218	ST24
E16R-STFCR 11-R	16	20	11	16	8	200	-5	0	✓	0.48	GI056	ST21
L E06H-STFCL 06-R	6	8.5	4.5	6	3	100	-10	0	✓	0.05	GI217	ST22
E08K-STFCL 06-R	8	11	5.9	8	4	125	-10	0	✓	0.09	GI217	ST23
E10M-STFCL 09-R	10	13	7	10	5	150	-8	0	✓	0.15	GI218	ST24
E12Q-STFCL 09-R	12	16	9	12	6	180	-6	0	✓	0.26	GI218	ST24
E16R-STFCL 11-R	16	20	11	16	8	200	-5	0	✓	0.48	GI056	ST21

GI056	TC.. 1102..
GI217	TC.. 06T1..
GI218	TC.. 0902..

ST21	5513 020-03	0.8	M 2.5	6.5	PT-8001
ST22	5513 020-28	0.6	M 2	4.2	PT-8000
ST23	5513 020-27	0.6	M 2	4.9	PT-8000
ST24	5513 020-05	0.8	M 2.2	6.4	PT-8001



TP

09/ 11/ 16

INSERTI IN METALLO DURO

TPGX



162

TPMR



163

TPUN



164

INSERTI CER

TPGN CER



164



TPGX



	IC	D1	L	S
	(mm)	(mm)	(mm)	(mm)
0902	5.560	2.50	9.60	2.38
1102	6.350	2.80	11.00	2.38
16T3	9.525	4.40	16.50	3.97

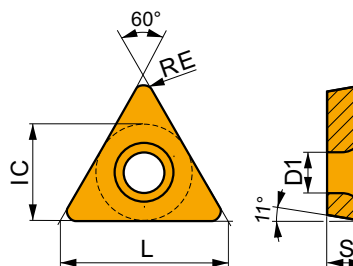

Idoneità e valori iniziali per velocità di taglio (Vc), avanzamento (f) e profondità di taglio (ap). Fare riferimento alla nostra App Machining Calculator per ulteriori calcoli.

Codice prodotto	RE	P			M			K			N			S			H			
		vc	f	ap	vc	f	ap	vc	f	ap	vc	f	ap	vc	f	ap	vc	f	ap	
	(mm)	(m/min)	(mm/rev)	(mm)	(m/min)	(mm/rev)	(mm)	(m/min)	(mm/rev)	(mm)	(m/min)	(mm/rev)	(mm)	(m/min)	(mm/rev)	(mm)	(m/min)	(mm/rev)	(mm)	
 FR-JQ geometria destra positiva, adatta per operazioni di super finitura, taglio continuo.	 1.2 20°	 F																		
			TT010	0.4	■ 295	0.06	0.5	☑ 175	0.05	0.5	■	■	■	■	■	■	■	■	■	■
 FL-JQ geometria positiva sinistra per operazioni di super finitura, taglio continuo.	 1.2 20°	 F																		
			TPGX 110204FR-JQ	TT010	0.4	■ 295	0.06	0.5	☑ 175	0.05	0.5	■	■	■	■	■	■	■	■	■
 FL-JR geometria positiva sinistra per operazioni di super finitura, taglio continuo.	 0.6 20°	 F																		
			TPGX 090204FL-JQ	TPGX 110204FL-JQ	TT010	0.4	■ 295	0.06	0.5	☑ 175	0.05	0.5	■	■	■	■	■	■	■	■
 FR-JZ geometria destra positiva, adatta per operazioni di super finitura, taglio continuo.	 1.2 20°	 F																		
			TPGX 16T304FL-JR	TT010	0.4	■ 295	0.06	0.5	☑ 175	0.05	0.5	■	■	■	■	■	■	■	■	■
 FL-JZ geometria positiva sinistra per operazioni di super finitura, taglio continuo.	 1.2 20°	 F																		
			TPGX 090202FR-JZ	TT010	0.2	■ 280	0.06	0.5	☑ 165	0.05	0.5	■	■	■	■	■	■	■	■	■
TPGX 090202FL-JZ	TT010	0.2	■ 280	0.06	0.5	☑ 165	0.05	0.5	■	■	■	■	■	■	■	■	■	■	■	■



TPMR



	IC (mm)	L (mm)	S (mm)
1103	6.350	11.00	3.18
1603	9.525	16.50	3.18

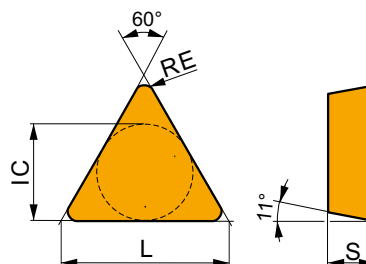

Idoneità e valori iniziali per velocità di taglio (Vc), avanzamento (f) e profondità di taglio (ap). Fare riferimento alla nostra App Machining Calculator per ulteriori calcoli.

Codice prodotto	RE (mm)	P			M			K			N			S			H		
		vc (m/min)	f (mm/rev)	ap (mm)	vc (m/min)	f (mm/rev)	ap (mm)	vc (m/min)	f (mm/rev)	ap (mm)	vc (m/min)	f (mm/rev)	ap (mm)	vc (m/min)	f (mm/rev)	ap (mm)	vc (m/min)	f (mm/rev)	ap (mm)

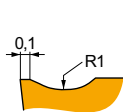

46 geometria per operazioni leggere e finitura, da taglio continuo a interrotto.

TPMR 110304E-46	6640	0.4	140	0.15	1.0	80	0.14	1.0	130	0.15	1.0	-	-	-	-	-	-	-
	T9325	0.4	175	0.15	1.0	105	0.15	1.0	165	0.15	1.0	-	-	-	-	-	-	-
	T9335	0.4	150	0.15	1.0	90	0.15	1.0	-	-	-	-	-	-	-	-	-	-
TPMR 110308E-46	6640	0.8	170	0.15	1.0	100	0.14	1.0	160	0.15	1.0	-	-	-	-	-	-	-
	T9325	0.8	205	0.15	1.0	120	0.15	1.0	190	0.15	1.0	-	-	-	-	-	-	-
	T9335	0.8	180	0.15	1.0	105	0.15	1.0	-	-	-	-	-	-	-	-	-	-

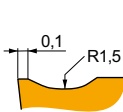

47 geometria per operazioni da finitura fino a semi sgrassatura, taglio continuo e interrotto.

TPMR 160304E-47	6640	0.4	120	0.20	1.5	70	0.18	1.5	110	0.20	1.5	-	-	-	-	-	-	-
	T9325	0.4	150	0.20	1.5	90	0.18	1.5	140	0.20	1.5	-	-	-	-	-	-	-
	T9335	0.4	125	0.20	1.5	75	0.18	1.5	-	-	-	-	-	-	-	-	-	-
TPMR 160308E-47	6640	0.8	140	0.20	1.5	80	0.18	1.5	130	0.20	1.5	-	-	-	-	-	-	-
	T9325	0.8	175	0.20	1.5	105	0.18	1.5	165	0.20	1.5	-	-	-	-	-	-	-
	T9335	0.8	150	0.20	1.5	90	0.18	1.5	-	-	-	-	-	-	-	-	-	-
TPMR 160312E-47	T9325	1.2	185	0.20	1.5	110	0.18	1.5	175	0.20	1.5	-	-	-	-	-	-	-
	T9335	1.2	160	0.20	1.5	95	0.18	1.5	-	-	-	-	-	-	-	-	-	-

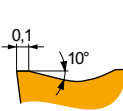

61 geometria per operazioni di finitura con moderati avanzamenti e profondità di taglio, da taglio continuo a interrotto.

TPMR 160308E-61	T9325	0.8	135	0.35	1.8	80	0.32	1.8	125	0.35	1.8	-	-	-	-	-	-	-
	T9335	0.8	120	0.35	1.8	70	0.32	1.8	-	-	-	-	-	-	-	-	-	-

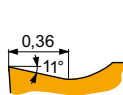

PF2 geometria per lavorazioni leggere fino a finitura, taglio continuo.

TPMR 110304-PF2	TT010	0.4	255	0.10	0.5	150	0.10	0.5	-	-	-	-	-	-	-	-	-	-
TPMR 160304-PF2	TT010	0.4	255	0.10	0.5	150	0.10	0.5	-	-	-	-	-	-	-	-	-	-



TPUN



	IC (mm)	L (mm)	S (mm)
1103	6.350	11.00	3.18
1603	9.525	16.50	3.18
2204	12.700	22.00	4.76
2706	15.875	27.50	6.35
3306	19.050	33.00	6.35

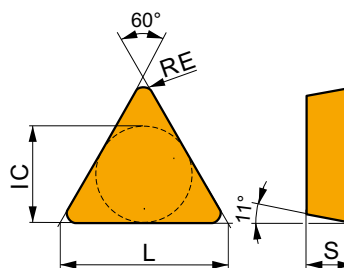

Idoneità e valori iniziali per velocità di taglio (Vc), avanzamento (f) e profondità di taglio (ap). Fare riferimento alla nostra App Machining Calculator per ulteriori calcoli.

Codice prodotto	RE (mm)	P			M			K			N			S			H		
		vc (m/min)	f (mm/rev)	ap (mm)	vc (m/min)	f (mm/rev)	ap (mm)	vc (m/min)	f (mm/rev)	ap (mm)	vc (m/min)	f (mm/rev)	ap (mm)	vc (m/min)	f (mm/rev)	ap (mm)	vc (m/min)	f (mm/rev)	ap (mm)

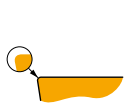

Adatta per operazioni da finitura fino a semi sgrassatura, da taglio continuo a leggermente interrotto.

TPUN 110304	6640	0.4	✓	135	0.10	1.2	–	–	–	■	125	0.10	1.2	–	–	–	–	–	–
TPUN 110308	6640	0.8	✓	125	0.18	1.2	–	–	–	■	115	0.18	1.2	–	–	–	–	–	–
TPUN 160304	6640	0.4	✓	135	0.10	1.5	–	–	–	■	125	0.10	1.5	–	–	–	–	–	–
TPUN 160308	6640	0.8	✓	125	0.18	1.5	–	–	–	■	115	0.18	1.5	–	–	–	–	–	–
TPUN 160312	6640	1.2	✓	125	0.20	1.5	–	–	–	■	115	0.20	1.5	–	–	–	–	–	–
TPUN 220408	6640	0.8	✓	120	0.18	2.0	–	–	–	■	110	0.18	2.0	–	–	–	–	–	–
TPUN 220412	6640	1.2	✓	120	0.20	2.0	–	–	–	■	110	0.20	2.0	–	–	–	–	–	–

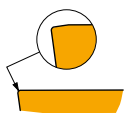

Adatta per operazioni da finitura fino a semi sgrassatura, da taglio continuo a leggermente interrotto.

TPUN 270616S	6640	1.6	✓	60	0.30	7.0	–	–	–	■	55	0.30	7.0	–	–	–	–	–	–
TPUN 330620S	6640	2.0	✓	65	0.30	5.0	–	–	–	■	60	0.30	5.0	–	–	–	–	–	–

TPGN CER



	IC (mm)	L (mm)	S (mm)
1103	6.350	11.00	3.18
1603	9.525	16.50	3.18

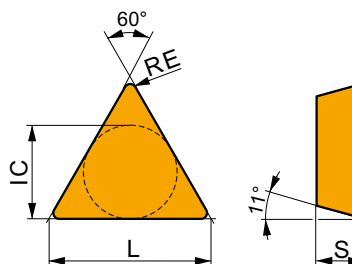

Idoneità e valori iniziali per velocità di taglio (Vc), avanzamento (f) e profondità di taglio (ap). Fare riferimento alla nostra App Machining Calculator per ulteriori calcoli.

Codice prodotto	RE (mm)	P			M			K			N			S			H		
		vc (m/min)	f (mm/rev)	ap (mm)	vc (m/min)	f (mm/rev)	ap (mm)	vc (m/min)	f (mm/rev)	ap (mm)	vc (m/min)	f (mm/rev)	ap (mm)	vc (m/min)	f (mm/rev)	ap (mm)	vc (m/min)	f (mm/rev)	ap (mm)

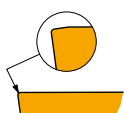

Adatta per lavorazioni con elevata velocità e taglio continuo.

TPGN 110304 T01020	TC100	0.4	–	–	–	–	–	–	–	■	460	0.10	1.5	–	–	–	–	–	–
TPGN 110308 T01020	TC100	0.8	–	–	–	–	–	–	–	■	425	0.20	1.5	–	–	–	–	–	–



Idoneità e valori iniziali per velocità di taglio (Vc), avanzamento (f) e profondità di taglio (ap). Fare riferimento alla nostra App Machining Calculator per ulteriori calcoli.

Codice prodotto	RE (mm)	P			M			K			N			S			H		
		vc (m/min)	f (mm/rev)	ap (mm)	vc (m/min)	f (mm/rev)	ap (mm)	vc (m/min)	f (mm/rev)	ap (mm)	vc (m/min)	f (mm/rev)	ap (mm)	vc (m/min)	f (mm/rev)	ap (mm)	vc (m/min)	f (mm/rev)	ap (mm)

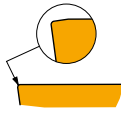

Adatta per lavorazioni con elevata velocità e taglio continuo.

TPGN 160304 T01020	TC100	0.4	-	-	-	-	-	-	460	0.10	1.5	-	-	-	-	-	-	-	-	-
TPGN 160308 T01020	TC100	0.8	-	-	-	-	-	-	425	0.20	1.5	-	-	-	-	-	-	-	-	-
TPGN 160312 T01020	TC100	1.2	-	-	-	-	-	-	450	0.20	1.5	-	-	-	-	-	-	-	-	-



VB

INSERTI IN METALLO DURO

VBMT



168

INSERTI CBN

VBGW CBN



171

ABBINAMENTO DELLA DIMENSIONE CORRETTA (esempio)

Inserto

VBMT 160408E-FM

Portainserito

SVHCR 2020 K 16-M-A

TORNITURA ISO - ESTERNA















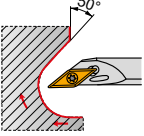
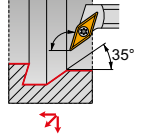
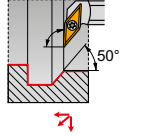
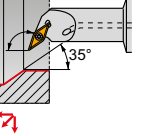





<p>SVHB(C)(RL) EXT</p> <p>107°30'</p> <p>VB, VC..</p> <p>11 16</p> <p>16x16 25x25</p> <p>172</p> <p>168 - 171 186 - 192</p>	<p>SVJB(C)(RL) EXT</p> <p>93°</p> <p>VB, VC..</p> <p>11 13 16</p> <p>12x12 32x25</p> <p>173</p> <p>168 - 171 186 - 192</p>	<p>SVPB(C)(RL) EXT</p> <p>117°30'</p> <p>VB, VC..</p> <p>11 16</p> <p>16x16 32x25</p> <p>174</p> <p>168 - 171 186 - 192</p>	<p>SVVB(C)N EXT</p> <p>72°30'</p> <p>VB, VC..</p> <p>11 13 16</p> <p>12x12 32x25</p> <p>175</p> <p>168 - 171 186 - 192</p>
<p>SVXB(C)(RL) EXT</p> <p>98°</p> <p>VB, VC..</p> <p>11 13 16</p> <p>12x12 32x25</p> <p>176</p> <p>168 - 171 186 - 192</p>	<p>C.-SVHB(RL) EXT NEW</p> <p>107°30'</p> <p>VB, VC..</p> <p>16</p> <p>C4 C6</p> <p>177</p> <p>168 - 171 186 - 192</p>	<p>C.-SVJB(RL) EXT NEW</p> <p>93°</p> <p>VB, VC..</p> <p>11 16</p> <p>C3 C6</p> <p>178</p> <p>168 - 171 186 - 192</p>	<p>C.-SVVB(N) EXT NEW</p> <p>72°30'</p> <p>VB, VC..</p> <p>16</p> <p>C4 C6</p> <p>179</p> <p>168 - 171 186 - 192</p>



VB

11/ 16

TORNITURA ISO INTERNA

SVJB(RL) INT		SVQB(C)(RL) INT		SVUB(C)(RL) INT		C.-SVQB(C)(RL) INT NEW	
93°	VB, VC..  11	107°30'	VB, VC..  11 13 16	93°	VB, VC..  11 13 16	108°	VB, VC..  16
							
 $\frac{25}{32}$		 $\frac{20}{50}$		 $\frac{20}{50}$		 33	
 180	 168 – 171  186 – 192	 181	 168 – 171  186 – 192	 182	 168 – 171  186 – 192	 183	 168 – 171  186 – 192



VBMT



	IC	D1	L	S
	(mm)	(mm)	(mm)	(mm)
1102	6.350	2.80	11.10	2.38
1103	6.350	2.80	11.10	3.18
1604	9.525	4.40	16.60	4.76

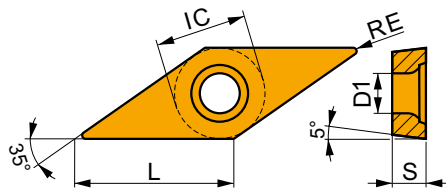

Idoneità e valori iniziali per velocità di taglio (Vc), avanzamento (f) e profondità di taglio (ap). Fare riferimento alla nostra App Machining Calculator per ulteriori calcoli.

Codice prodotto	RE (mm)	P			M			K			N			S			H		
		vc (m/min)	f (mm/rev)	ap (mm)	vc (m/min)	f (mm/rev)	ap (mm)	vc (m/min)	f (mm/rev)	ap (mm)	vc (m/min)	f (mm/rev)	ap (mm)	vc (m/min)	f (mm/rev)	ap (mm)	vc (m/min)	f (mm/rev)	ap (mm)

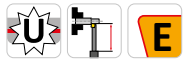
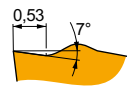

FF2 geometria positiva per operazioni da super finitura fino a finitura, da taglio continuo a leggermente interrotto.

VBMT 160404E-FF2	T7325	0.4	145	0.12	0.8	-	-	-	-	-	-	-	-	-	-	-	-	-
	T8330	0.4	125	0.12	0.8	-	-	-	115	0.12	0.8	-	-	-	-	-	-	-
	T8430	0.4	150	0.12	0.8	-	-	-	125	0.12	0.8	-	-	-	-	-	-	-
	T9315	0.4	215	0.12	0.8	-	-	-	200	0.12	0.8	-	-	-	-	-	-	-
	T9325	0.4	190	0.12	0.8	-	-	-	180	0.12	0.8	-	-	-	-	-	-	-
	T9335	0.4	160	0.12	0.8	-	-	-	-	-	-	-	-	-	-	-	-	-

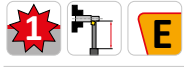
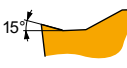

FM geometria per operazioni da finitura fino a semi sgrassatura, da taglio continuo a leggermente interrotto.

VBMT 110302E-FM	T7325	0.2	160	0.10	0.8	120	0.09	0.8	-	-	-	-	-	-	-	-	-
	T8315	0.2	145	0.10	0.8	85	0.09	0.8	135	0.10	0.8	435	0.12	0.8	-	-	-
	T8330	0.2	135	0.10	0.8	80	0.09	0.8	125	0.10	0.8	405	0.12	0.8	-	-	-
	T8430	0.2	170	0.10	0.8	90	0.09	0.8	135	0.10	0.8	465	0.12	0.8	-	-	-
	T9325	0.2	210	0.10	0.8	125	0.09	0.8	195	0.10	0.8	-	-	-	-	-	-
	T9335	0.2	180	0.10	0.8	110	0.09	0.8	-	-	-	-	-	-	-	-	-
VBMT 110304E-FM	T7325	0.4	140	0.19	0.8	105	0.17	0.8	-	-	-	-	-	-	-	-	-
	T7335	0.4	135	0.19	0.8	105	0.17	0.8	-	-	-	-	-	-	-	-	-
	T8315	0.4	145	0.12	0.8	85	0.11	0.8	135	0.12	0.8	435	0.14	0.8	-	-	-
	T8330	0.4	140	0.12	0.8	80	0.11	0.8	130	0.12	0.8	420	0.14	0.8	-	-	-
	T8430	0.4	170	0.12	0.8	90	0.11	0.8	135	0.12	0.8	465	0.14	0.8	-	-	-
	T9315	0.4	235	0.12	0.8	-	-	-	220	0.12	0.8	-	-	-	-	-	-
VBMT 110308E-FM	T7325	0.8	170	0.17	0.8	130	0.15	0.8	-	-	-	-	-	-	-	-	-
	T8330	0.8	150	0.17	0.8	90	0.15	0.8	140	0.17	0.8	450	0.20	0.8	-	-	-
	T8430	0.8	175	0.17	0.8	95	0.15	0.8	140	0.17	0.8	480	0.20	0.8	-	-	-
	T9315	0.8	240	0.17	0.8	-	-	-	225	0.17	0.8	-	-	-	-	-	-
	T9325	0.8	215	0.17	0.8	125	0.15	0.8	200	0.17	0.8	-	-	-	-	-	-
	T9335	0.8	180	0.17	0.8	110	0.15	0.8	-	-	-	-	-	-	-	-	-
VBMT 160402E-FM	T7325	0.2	150	0.10	1.2	115	0.09	1.2	-	-	-	-	-	-	-	-	-
	T8330	0.2	130	0.10	1.2	75	0.09	1.2	120	0.10	1.2	390	0.12	1.2	-	-	-
	T8430	0.2	165	0.10	1.2	90	0.09	1.2	135	0.10	1.2	450	0.12	1.2	-	-	-
	T9315	0.2	230	0.10	1.2	-	-	-	215	0.10	1.2	-	-	-	-	-	-
	T9325	0.2	205	0.10	1.2	120	0.09	1.2	190	0.10	1.2	-	-	-	-	-	-
	T9335	0.2	175	0.10	1.2	105	0.09	1.2	-	-	-	-	-	-	-	-	-
VBMT 160404E-FM	T5315	0.4	225	0.12	1.2	-	-	-	210	0.12	1.2	-	-	-	-	-	-
	T7325	0.4	130	0.19	1.2	100	0.17	1.2	-	-	-	-	-	-	-	-	-
	T7335	0.4	130	0.19	1.2	100	0.17	1.2	-	-	-	-	-	-	-	-	-
	T8315	0.4	140	0.12	1.2	80	0.11	1.2	130	0.12	1.2	420	0.14	1.2	-	-	-
	T8330	0.4	135	0.12	1.2	80	0.11	1.2	125	0.12	1.2	405	0.14	1.2	-	-	-
	T8430	0.4	165	0.12	1.2	90	0.11	1.2	135	0.12	1.2	450	0.14	1.2	-	-	-
	T9315	0.4	225	0.12	1.2	-	-	-	210	0.12	1.2	-	-	-	-	-	-
	T9325	0.4	165	0.19	1.2	95	0.17	1.2	155	0.19	1.2	-	-	-	-	-	-



Idoneità e valori iniziali per velocità di taglio (Vc), avanzamento (f) e profondità di taglio (ap). Fare riferimento alla nostra App Machining Calculator per ulteriori calcoli.

Codice prodotto	RE  (mm)	P			M			K			N			S			H		
		vc (m/min)	f (mm/rev)	ap (mm)	vc (m/min)	f (mm/rev)	ap (mm)	vc (m/min)	f (mm/rev)	ap (mm)	vc (m/min)	f (mm/rev)	ap (mm)	vc (m/min)	f (mm/rev)	ap (mm)	vc (m/min)	f (mm/rev)	ap (mm)

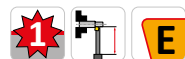
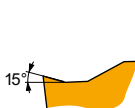

FM geometria per operazioni da finitura fino a semi sgrassatura, da taglio continuo a leggermente interrotto.

VBMT 160408E-FM	T5315	0.8	235	0.17	1.2	-	-	-	220	0.17	1.2	-	-	-	-	-	-	-	-
	T7325	0.8	165	0.17	1.2	125	0.15	1.2	-	-	-	-	-	-	-	-	-	-	-
	T7335	0.8	160	0.17	1.2	120	0.15	1.2	-	-	-	-	-	-	-	-	-	-	-
	T8315	0.8	150	0.17	1.2	90	0.15	1.2	140	0.17	1.2	450	0.20	1.2	-	-	-	-	-
	T8330	0.8	145	0.17	1.2	85	0.15	1.2	135	0.17	1.2	435	0.20	1.2	-	-	-	-	-
	T8430	0.8	170	0.17	1.2	90	0.15	1.2	135	0.17	1.2	465	0.20	1.2	-	-	-	-	-
	T9310	0.8	255	0.17	1.2	-	-	-	240	0.17	1.2	-	-	-	-	-	-	-	-
	T9315	0.8	230	0.17	1.2	-	-	-	215	0.17	1.2	-	-	-	-	-	-	-	-
	T9325	0.8	205	0.17	1.2	120	0.15	1.2	190	0.17	1.2	-	-	-	-	-	-	-	-
	VBMT 160412E-FM	T7325	1.2	160	0.22	1.2	120	0.22	1.2	-	-	-	-	-	-	-	-	-	-
T8330		1.2	140	0.22	1.2	80	0.22	1.2	130	0.22	1.2	420	0.26	1.2	-	-	-	-	
T8430		1.2	155	0.22	1.2	85	0.22	1.2	130	0.22	1.2	435	0.26	1.2	-	-	-	-	
T9315		1.2	215	0.22	1.2	-	-	-	200	0.22	1.2	-	-	-	-	-	-	-	
T9325		1.2	195	0.22	1.2	115	0.22	1.2	185	0.22	1.2	-	-	-	-	-	-	-	

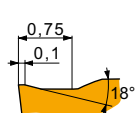

FM2 geometria per operazioni da finitura fino a lavorazioni medie, da taglio continuo a interrotto.

VBMT 160404E-FM2	T6310	0.4	120	0.12	1.2	85	0.11	1.2	95	0.12	1.2	-	-	-	-	-	-	-
	T7325	0.4	140	0.12	1.2	105	0.11	1.2	-	-	-	-	-	-	-	-	-	-
	T8330	0.4	125	0.12	1.2	75	0.11	1.2	115	0.12	1.2	-	-	-	-	-	-	-
	T8430	0.4	145	0.12	1.2	80	0.11	1.2	120	0.12	1.2	-	-	-	-	-	-	-
	T9315	0.4	200	0.12	1.2	-	-	-	190	0.12	1.2	-	-	-	-	-	-	-
	T9325	0.4	185	0.12	1.2	110	0.11	1.2	175	0.12	1.2	-	-	-	-	-	-	-
VBMT 160408E-FM2	T6310	0.8	125	0.20	1.2	90	0.18	1.2	100	0.20	1.2	-	-	-	-	-	-	-
	T7325	0.8	145	0.20	1.2	110	0.18	1.2	-	-	-	-	-	-	-	-	-	-
	T8330	0.8	125	0.20	1.2	75	0.18	1.2	115	0.20	1.2	-	-	-	-	-	-	-
	T8430	0.8	140	0.20	1.2	75	0.18	1.2	115	0.20	1.2	-	-	-	-	-	-	-
	T9315	0.8	195	0.20	1.2	-	-	-	185	0.20	1.2	-	-	-	-	-	-	-
	T9325	0.8	175	0.20	1.2	105	0.18	1.2	165	0.20	1.2	-	-	-	-	-	-	-
VBMT 160412E-FM2	T8430	1.2	145	0.22	1.2	80	0.20	1.2	120	0.22	1.2	-	-	-	-	-	-	-
	T9315	1.2	195	0.22	1.2	-	-	-	185	0.22	1.2	-	-	-	-	-	-	-
	T9325	1.2	175	0.22	1.2	105	0.20	1.2	165	0.22	1.2	-	-	-	-	-	-	

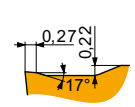

RM geometria per operazioni da semi sgrassatura fino a sgrassatura, da taglio continuo a interrotto.

VBMT 160404E-RM	T5305	0.4	270	0.12	1.2	-	-	-	255	0.12	1.2	-	-	-	-	-	50	0.15	1.0	
	T5315	0.4	235	0.12	1.2	-	-	-	220	0.12	1.2	-	-	-	-	-	45	0.15	1.0	
	T7335	0.4	140	0.18	1.2	105	0.16	1.2	-	-	-	45	0.16	1.0	-	-	-	-		
	T8330	0.4	140	0.12	1.2	80	0.11	1.2	130	0.12	1.2	-	-	-	35	0.11	1.0	25	0.15	1.0
	T8430	0.4	170	0.12	1.2	90	0.11	1.2	135	0.12	1.2	-	-	-	35	0.11	1.0	25	0.15	1.0
	T9315	0.4	235	0.12	1.2	-	-	-	220	0.12	1.2	-	-	-	-	-	-	45	0.15	1.0
VBMT 160408E-RM	T9325	0.4	170	0.20	1.2	100	0.18	1.2	160	0.20	1.2	-	-	-	35	0.18	1.0	-	-	
	T5305	0.8	285	0.17	1.2	-	-	-	270	0.17	1.2	-	-	-	-	-	55	0.15	1.0	
	T5315	0.8	250	0.17	1.2	-	-	-	235	0.17	1.2	-	-	-	-	-	50	0.15	1.0	
	T7335	0.8	155	0.20	1.2	120	0.18	1.2	-	-	-	50	0.18	1.0	-	-	-	-		
	T8330	0.8	150	0.17	1.2	90	0.15	1.2	140	0.17	1.2	-	-	-	35	0.12	1.0	30	0.15	1.0
	T8430	0.8	175	0.17	1.2	95	0.15	1.2	140	0.17	1.2	-	-	-	35	0.12	1.0	30	0.15	1.0
	T9315	0.8	240	0.17	1.2	-	-	-	225	0.17	1.2	-	-	-	-	-	45	0.15	1.0	
	T9325	0.8	200	0.20	1.2	120	0.18	1.2	190	0.20	1.2	-	-	-	45	0.18	1.0	-	-	



Idoneità e valori iniziali per velocità di taglio (Vc), avanzamento (f) e profondità di taglio (ap). Fare riferimento alla nostra App Machining Calculator per ulteriori calcoli.

Codice prodotto	RE  (mm)	P			M			K			N			S			H		
		vc (m/min)	f (mm/rev)	ap (mm)	vc (m/min)	f (mm/rev)	ap (mm)	vc (m/min)	f (mm/rev)	ap (mm)	vc (m/min)	f (mm/rev)	ap (mm)	vc (m/min)	f (mm/rev)	ap (mm)	vc (m/min)	f (mm/rev)	ap (mm)

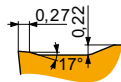

RM geometria per operazioni da semi sgrossatura fino a sgrossatura, da taglio continuo a interrotto.

VBMT 160412E-RM	T7335	1.2	✓	150	0.27	1.2	■	115	0.24	1.2	■	–	–	–	■	45	0.19	1.0	–	–	–	
	T8330	1.2	■	140	0.27	1.2	■	80	0.24	1.2	■	130	0.27	1.2	■	35	0.19	1.0	■	25	0.15	1.0
	T8430	1.2	■	155	0.27	1.2	■	85	0.24	1.2	■	130	0.27	1.2	■	30	0.19	1.0	■	25	0.15	1.0
	T9315	1.2	■	210	0.27	1.2	■	–	–	–	■	195	0.27	1.2	■	–	–	–	■	40	0.15	1.0
	T9325	1.2	■	185	0.27	1.2	■	110	0.24	1.2	■	175	0.27	1.2	■	40	0.19	1.0	–	–	–	

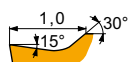

UR geometria per lavorazioni leggere e finitura, da taglio continuo a leggermente interrotto.

VBMT 110202E-UR	TT310	0.2	■	195	0.10	0.8	■	115	0.09	0.8	■	–	–	–	–	–	–	–	–	–	–	
VBMT 110204E-UR	T7325	0.4	■	120	0.19	0.8	■	90	0.17	0.8	■	–	–	–	–	–	–	–	–	–	–	
	T8330	0.4	■	120	0.12	0.8	■	70	0.11	0.8	■	110	0.12	0.8	■	–	–	–	–	–	–	
	T8430	0.4	■	145	0.12	0.8	■	80	0.11	0.8	■	120	0.12	0.8	■	–	–	–	–	–	–	
	T9315	0.4	■	200	0.12	0.8	■	–	–	–	■	190	0.12	0.8	■	–	–	–	–	–	–	
	T9325	0.4	■	150	0.19	0.8	■	90	0.17	0.8	■	140	0.19	0.8	■	–	–	–	–	–	–	
VBMT 160402E-UR	TT310	0.4	■	195	0.12	0.8	■	115	0.11	0.8	■	–	–	–	–	–	–	–	–	–	–	
	T8330	0.2	■	115	0.10	1.2	■	65	0.09	1.2	■	105	0.10	1.2	■	–	–	–	–	–	–	
	T8430	0.2	■	140	0.10	1.2	■	75	0.09	1.2	■	115	0.10	1.2	■	–	–	–	–	–	–	
	VBMT 160404E-UR	T5315	0.4	■	195	0.12	1.2	■	–	–	–	■	185	0.12	1.2	■	–	–	–	–	–	–
		T7325	0.4	■	115	0.19	1.2	■	85	0.17	1.2	■	–	–	–	–	–	–	–	–	–	–
T8330		0.4	■	115	0.12	1.2	■	65	0.11	1.2	■	105	0.12	1.2	■	–	–	–	–	–	–	
T8430		0.4	■	140	0.12	1.2	■	75	0.11	1.2	■	115	0.12	1.2	■	–	–	–	–	–	–	
T9310		0.4	■	215	0.12	1.2	■	–	–	–	■	200	0.12	1.2	■	–	–	–	–	–	–	
VBMT 160408E-UR	T9315	0.4	■	190	0.12	1.2	■	–	–	–	■	180	0.12	1.2	■	–	–	–	–	–	–	
	T9325	0.4	■	145	0.18	1.2	■	85	0.16	1.2	■	135	0.18	1.2	■	–	–	–	–	–	–	
	TT310	0.4	■	185	0.12	1.2	■	110	0.11	1.2	■	–	–	–	–	–	–	–	–	–	–	
	T5315	0.8	■	205	0.17	1.2	■	–	–	–	■	190	0.17	1.2	■	–	–	–	–	–	–	
	T7325	0.8	■	140	0.17	1.2	■	105	0.15	1.2	■	–	–	–	–	–	–	–	–	–	–	
VBMT 160412E-UR	T8330	0.8	■	125	0.17	1.2	■	75	0.15	1.2	■	115	0.17	1.2	■	–	–	–	–	–	–	
	T8430	0.8	■	145	0.17	1.2	■	80	0.15	1.2	■	120	0.17	1.2	■	–	–	–	–	–	–	
	T9310	0.8	■	220	0.17	1.2	■	–	–	–	■	205	0.17	1.2	■	–	–	–	–	–	–	
	T9315	0.8	■	200	0.17	1.2	■	–	–	–	■	190	0.17	1.2	■	–	–	–	–	–	–	
	T9325	0.8	■	180	0.17	1.2	■	105	0.15	1.2	■	170	0.17	1.2	■	–	–	–	–	–	–	
VBMT 160412E-UR	TT310	0.8	■	200	0.17	1.2	■	120	0.15	1.2	■	–	–	–	–	–	–	–	–	–	–	
	T7325	1.2	■	135	0.22	1.2	■	105	0.20	1.2	■	–	–	–	–	–	–	–	–	–	–	
	T8330	1.2	■	120	0.22	1.2	■	70	0.20	1.2	■	110	0.22	1.2	■	–	–	–	–	–	–	
	T8430	1.2	■	135	0.22	1.2	■	75	0.20	1.2	■	110	0.22	1.2	■	–	–	–	–	–	–	
	T9310	1.2	■	205	0.22	1.2	■	–	–	–	■	190	0.22	1.2	■	–	–	–	–	–	–	
T9315	1.2	■	185	0.22	1.2	■	–	–	–	■	175	0.22	1.2	■	–	–	–	–	–	–		
T9325	1.2	■	170	0.22	1.2	■	100	0.20	1.2	■	160	0.22	1.2	■	–	–	–	–	–	–		



VBGW CBN



	IC	D1	L	S
	(mm)	(mm)	(mm)	(mm)
1604	9.525	4.50	16.00	4.76

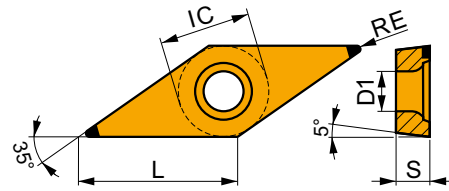

Idoneità e valori iniziali per velocità di taglio (Vc), avanzamento (f) e profondità di taglio (ap). Fare riferimento alla nostra App Machining Calculator per ulteriori calcoli.

Codice prodotto	RE (mm)	P			M			K			N			S			H		
		vc (m/min)	f (mm/rev)	ap (mm)	vc (m/min)	f (mm/rev)	ap (mm)	vc (m/min)	f (mm/rev)	ap (mm)	vc (m/min)	f (mm/rev)	ap (mm)	vc (m/min)	f (mm/rev)	ap (mm)	vc (m/min)	f (mm/rev)	ap (mm)

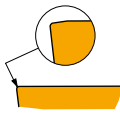

Adatta per operazioni di finitura e taglio continuo.

VBGW 160404S01020B	TB310	0.4	-	-	-	-	-	-	☑	340	0.10	0.4	-	-	-	☑	90	0.07	0.3	■	70	0.15	1.0
VBGW 160408S01020B	TB310	0.8	-	-	-	-	-	-	☑	350	0.15	0.6	-	-	-	☑	90	0.11	0.5	■	70	0.15	1.0



SVHB(C)(RL) EXT



Utensile esterno, bloccaggio a vite, inserti VB/VC... angolo del tagliente utensile 107.5°

Utensile di tornitura esterna destro/sinistro con bloccaggio a vite, angolo del tagliente utensile 107.5° per inserti positivi VB...11 o 16 e VC...11 o 16. Adatto per operazioni di sfacciatura, tornitura longitudinale con spallamento, copiatura frontale e longitudinale fino a 35°, conicità e smussi. Disponibile con stelo da 16x16 a 25x25 mm. Corpo trattato per una maggiore durata.

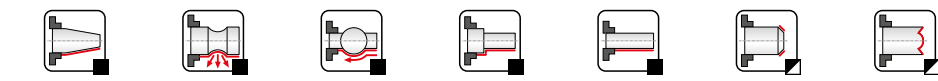
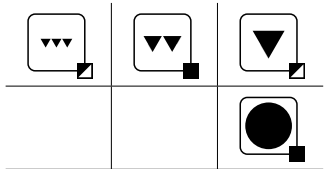
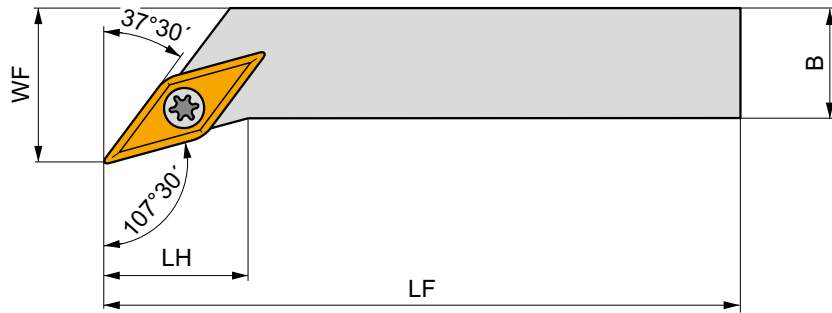
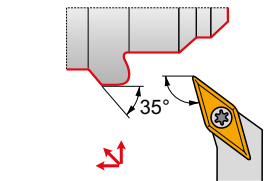

Codice prodotto	H	B	HF	WF	LF	LH	LAMS	GAMO	kg	GI	SV
	(mm)	(mm)	(mm)	(mm)	(mm)	(mm)	(°)	(°)			
R SVHBR 1616 H 11	16	16	16	20	100	14	0	0	0.21	GI194	S01
SVHCR 2020 K 16-M-A	20	20	20	25	125	20	0	0	0.40	GI017	SV10
SVHCR 2525 M 16-M-A	25	25	25	32	150	20	0	0	0.68	GI017	SV10
L SVHBL 1616 H 11	16	16	16	20	100	14	0	0	0.19	GI194	S01
SVHCL 2020 K 16-M-A	20	20	20	25	125	20	0	0	0.40	GI017	SV10
SVHCL 2525 M 16-M-A	25	25	25	32	150	20	0	0	0.07	GI017	SV10

GI	VB..	VC..
GI017	VB.. 1604..	VC.. 1604..
GI194	VB.. 1103..	VC.. 1103..

SV	US	Nm	M	mm	SVN	MS	FLAG	HXK
S01	US 2506-T07P	0.9	M 2.5	6.3	-	-	FLAG T07P	-
SV10	US 3512-T15P	3.0	M 3.5	12.6	SVN 160304	MS 3510	FLAG T15P	HXK 3.5



SVJB(C)(RL) EXT



Utensile esterno, bloccaggio a vite, inserti VB/VC... angolo del tagliente utensile 93°

Utensile di tornitura esterna destro/sinistro con bloccaggio a vite, angolo del tagliente utensile 93° per inserti positivi VB...11 o 16 e VC...11, 13 o 16. Adatto per operazioni di tornitura longitudinale con spallamento, copiatura fino a 50°, conicità e smussi. Disponibile con stelo da 12x12 a 32x25 mm. Corpo trattato per una maggiore durata.

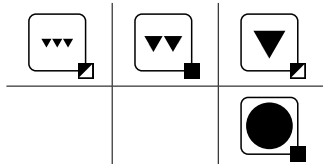
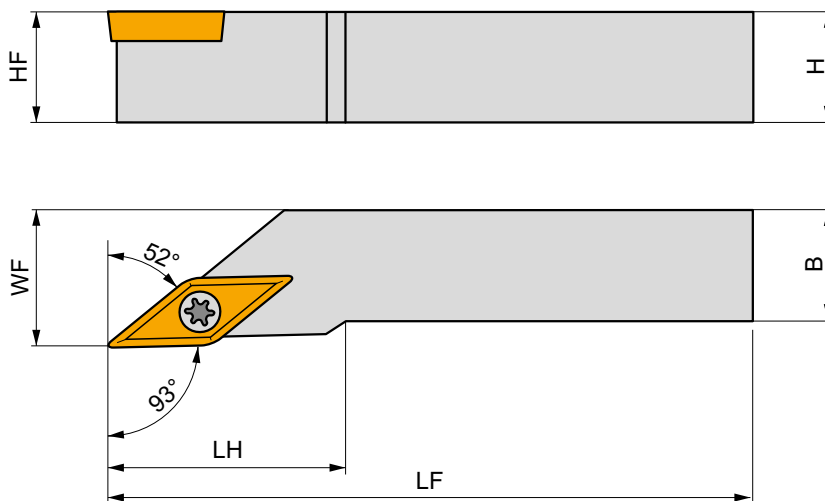
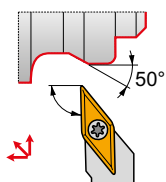

Codice prodotto	H	B	HF	WF	LF	LH	LAMS	GAMO	kg			
	(mm)	(mm)	(mm)	(mm)	(mm)	(mm)	(°)	(°)				
R	SVJBR 1212 F 11	12	12	12	16	80	20	0	0	0.09	GI194	S01
	SVJBR 1616 H 11	16	16	16	20	100	20	0	0	0.20	GI194	S01
	SVJCR 1212 N 13	12	12	12	16	160	27	0	0	0.19	GI211	SV21
	SVJCR 1616 H 13	16	16	16	20	100	30	0	0	0.20	GI211	SV21
	SVJCR 2020 K 13	20	20	20	25	125	30	0	0	0.37	GI211	SV22
	SVJCR 2525 M 13	25	25	25	32	150	30	0	0	0.67	GI211	SV22
	SVJCR 2020 K 16-M-A	20	20	20	25	125	28	0	0	0.35	GI017	SV10
	SVJCR 2525 M 16-M-A	25	25	25	32	150	32	0	0	0.68	GI017	SV10
	SVJCR 3225 P 16-M-A	32	25	32	32	170	32	0	0	0.99	GI017	SV10
L	SVJBL 1212 F 11	12	12	12	16	80	20	0	0	0.09	GI194	S01
	SVJBL 1616 H 11	16	16	16	20	100	20	0	0	0.19	GI194	S01
	SVJCL 1212 N 13	12	12	12	16	160	27	0	0	0.19	GI211	SV21
	SVJCL 1616 H 13	16	16	16	20	100	30	0	0	0.20	GI211	SV21
	SVJCL 2020 K 13	20	20	20	25	125	30	0	0	0.37	GI211	SV22
	SVJCL 2525 M 13	25	25	25	32	150	30	0	0	0.67	GI211	SV22
	SVJCL 2020 K 16-M-A	20	20	20	25	125	28	0	0	0.40	GI017	SV10
	SVJCL 2525 M 16-M-A	25	25	25	32	150	32	0	0	0.70	GI017	SV10
	SVJCL 3225 P 16-M-A	32	25	32	32	170	32	0	0	0.99	GI017	SV10



GI017

VB.. 1604..

VC.. 1604..

GI194

VB.. 1103..

VC.. 1103..

GI211

-

VC.. 1303..



S01

US 2506-T07P

0.9

M 2.5

6.3

-

-

FLAG T07P

-

SV10

US 3512-T15P

3.0

M 3.5

12.6

SVN 160304

MS 3510

FLAG T15P

HXK 3.5

SV21

5513 020-24

1.5

M 3

8.5

-

-

PT-8002

-

SV22

DVF 0573

1.5

M 3

10.3

DAP 0331

DVT 0332

PT-8002

174.1-870



SVPB(C)(RL) EXT

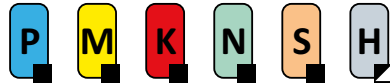

Utensile esterno, bloccaggio a vite, inserti VB/VC... angolo del tagliente utensile 117.5°

Utensile di tornitura esterna destro/sinistro con bloccaggio a vite, angolo del tagliente utensile 117.5° per inserti positivi VB...11 o 16 e VC...11 o 16. Adatto per operazioni di sfacciatura, tornitura longitudinale con spallamento, copiatura frontale fino a 25°, conicità e smussi. Disponibile con stelo da 16x16 a 32x25 mm. Corpo trattato per una maggiore durata.

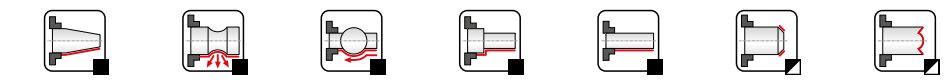
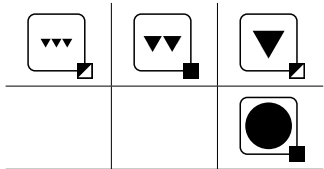
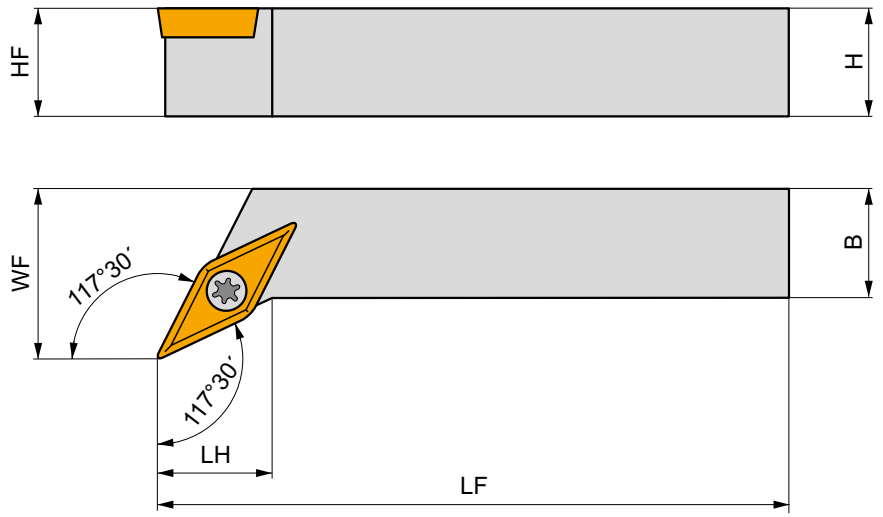
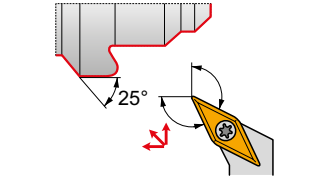

Codice prodotto	H	B	HF	WF	LF	LH	LAMS	GAMO	kg	Icona 1	Icona 2
	(mm)	(mm)	(mm)	(mm)	(mm)	(mm)	(°)	(°)			
R SVPBR 1616 H 11	16	16	16	20	100	12	0	0	0.20	GI194	S01
SVPBR 2020 K 11	20	20	20	25	125	12	0	0	0.41	GI194	S01
SVPCR 2020 K 16-M-A	20	20	20	25	125	20	0	0	0.40	GI017	SV10
SVPCR 2525 M 16-M-A	25	25	25	32	150	25	0	0	0.75	GI017	SV10
SVPCR 3225 P 16-M-A	32	25	32	32	170	25	0	0	1.10	GI017	SV10
L SVPBL 1616 H 11	16	16	16	20	100	12	0	0	0.20	GI194	S01
SVPBL 2020 K 11	20	20	20	25	125	12	0	0	0.39	GI194	S01
SVPCL 2020 K 16-M-A	20	20	20	25	125	20	0	0	0.70	GI017	SV10
SVPCL 2525 M 16-M-A	25	25	25	32	150	25	0	0	0.70	GI017	SV10
SVPCL 3225 P 16-M-A	32	25	32	32	170	25	0	0	1.10	GI017	SV10

Icona	Inserti VB	Inserti VC
GI017	VB.. 1604..	VC.. 1604..
GI194	VB.. 1103..	VC.. 1103..

Icona 1	Icona 2	Icona 3	Icona 4	Icona 5	Icona 6	Icona 7	Icona 8	Icona 9
S01	US 2506-T07P	0.9 Nm	M 2.5	6.3	-	-	FLAG T07P	-
SV10	US 3512-T15P	3.0 Nm	M 3.5	12.6	SVN 160304	MS 3510	FLAG T15P	HXK 3.5



SVVB(C)N EXT



Utensile esterno, bloccaggio a vite, angolo del tagliente utensile 72,5°, inserti VB/VC..

Utensile esterno di tornitura, neutro, bloccaggio a vite per inserti positivi VB .. 11 o 16 e VC .. da 11 fino a 16. Adatto per tornitura longitudinale esterna senza spallamento, tornitura conica, a copiare fino a 72,5° e smussi. Disponibile con dimensioni stelo da 12x12 fino a 32x25 mm. Corpo trattato per una maggiore durata dell'utensile.

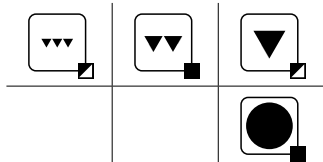
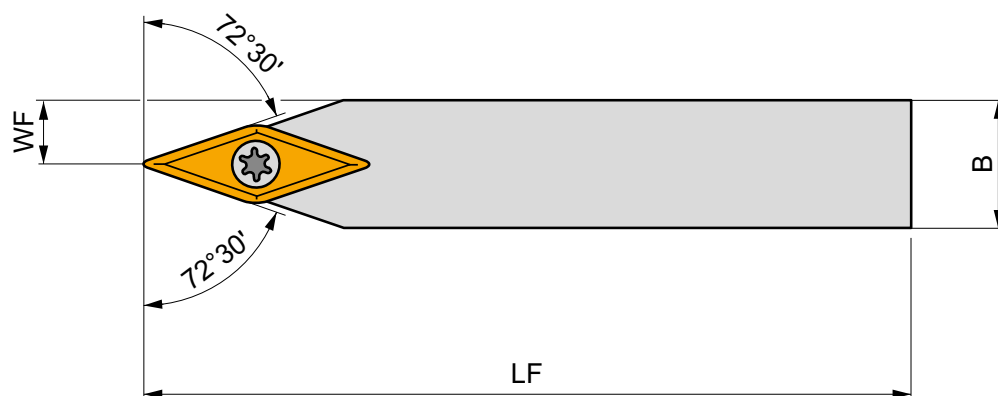
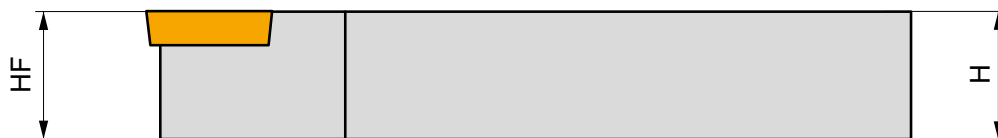
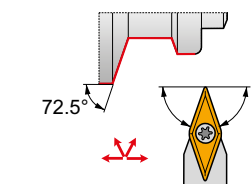

Codice prodotto	H	B	HF	WF	LF	LH	LAMS	GAMO	kg	G1194	S01
	(mm)	(mm)	(mm)	(mm)	(mm)	(mm)	(°)	(°)			
SVVBN 1212 F 11	12	12	12	6	80	-	0	0	0.11	G1194	S01
SVVBN 1616 H 11	16	16	16	8	100	-	0	0	0.18	G1194	S01
SVVBN 2020 K 11	20	20	20	10	125	-	0	0	0.38	G1194	S01
SVVCN 1212 N 13	12	12	12	6	160	-	0	0	0.19	G1211	SV21
SVVCN 1616 H 13	16	16	16	8	100	-	0	0	0.20	G1211	SV21
SVVCN 2020 K 13	20	20	20	10	125	-	0	0	0.36	G1211	SV22
SVVCN 2525 M 13	25	25	25	12.5	150	-	0	0	0.66	G1211	SV22
SVVCN 2020 K 16-M-A	20	20	20	10	125	-	0	0	0.34	G1017	SV10
SVVCN 2525 M 16-M-A	25	25	25	12.5	150	-	0	0	0.68	G1017	SV10
SVVCN 3225 P 16-M-A	32	25	32	12.5	170	-	0	0	0.98	G1017	SV10



G1017

VB.. 1604..

VC.. 1604..

G1194

VB.. 1103..

VC.. 1103..

G1211

-

VC.. 1303..



S01

US 2506-T07P

0.9

M 2.5

6.3

-

-

FLAG T07P

-

SV10

US 3512-T15P

3.0

M 3.5

12.6

SVN 160304

MS 3510

FLAG T15P

HXK 3.5

SV21

5513 020-24

1.5

M 3

8.5

-

-

PT-8002

-

SV22

DVF 0573

1.5

M 3

10.3

DAP 0331

DVT 0332

PT-8002

174.1-870



SVXB(C)(RL) EXT

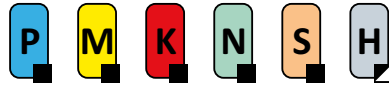

PRAMET

S



Utensile esterno, bloccaggio a vite, inserti VB/VC... angolo del tagliente utensile 98/113°

Utensile di tornitura esterna destro/sinistro con bloccaggio a vite, angolo del tagliente utensile 98/113° per inserti positivi VB...11 o 16 e da VC...11 13 16. Adatto per operazioni di tornitura longitudinale con spallamento, copiatura fino a 30°, conicità e smussi. Disponibile con stelo da 12x12 a 32x25 mm. Corpo trattato per una maggiore durata.

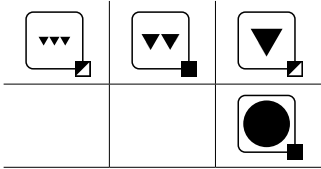
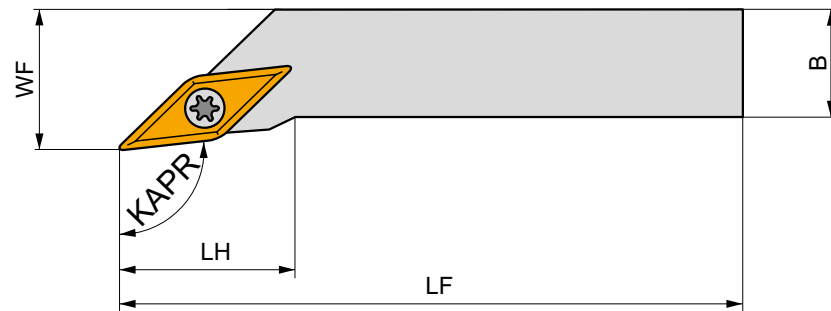
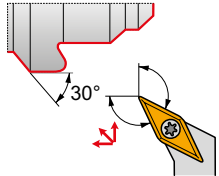

Codice prodotto	H	B	HF	WF	LF	LH	KAPR	LAMS	GAMO	kg	GI	SV
	(mm)	(mm)	(mm)	(mm)	(mm)	(mm)	(°)	(°)	(°)			
R SVXBR 1212 F 11	12	12	12	16	80	20	98	0	0	0.09	GI194	SO1
SVXBR 1616 H 11	16	16	16	20	100	14	98	0	0	0.19	GI194	SO1
SVXCR 2020 K 13	20	20	20	25	125	12	113	0	0	0.38	GI211	SV22
SVXCR 2020 K 16-M-A	20	20	20	25	125	28	98	0	0	0.41	GI017	SV10
SVXCR 2525 M 16-M-A	25	25	25	32	150	32	98	0	0	0.68	GI017	SV10
SVXCR 3225 P 16-M-A	32	25	32	32	170	32	98	0	0	1.00	GI017	SV10
L SVXBL 1212 F 11	12	12	12	16	80	20	98	0	0	0.09	GI194	SO1
SVXBL 1616 H 11	16	16	16	20	100	14	98	0	0	0.19	GI194	SO1
SVXCL 2020 K 13	20	20	20	25	125	12	113	0	0	0.38	GI211	SV22
SVXCL 2020 K 16-M-A	20	20	20	25	125	28	98	0	0	0.38	GI017	SV10
SVXCL 2525 M 16-M-A	25	25	25	32	150	32	98	0	0	0.69	GI017	SV10
SVXCL 3225 P 16-M-A	32	25	32	32	170	32	98	0	0	0.99	GI017	SV10

GI	VB..	VC..
GI017	VB.. 1604..	VC.. 1604..
GI194	VB.. 1103..	VC.. 1103..
GI211	-	VC.. 1303..

SV	US	Nm	M	mm	mm	mm	mm	mm	mm
SO1	US 2506-T07P	0.9	M 2.5	6.3	-	-	FLAG T07P	-	-
SV10	US 3512-T15P	3.0	M 3.5	12.6	SVN 160304	MS 3510	FLAG T15P	HXK 3.5	-
SV22	DVF 0573	1.5	M 3	10.3	DAP 0331	DVT 0332	PT-8002	174.1-870	-

NEW
C.-SVHB(RL) EXT

S

Utensile PSC esterno a cambio rapido, bloccaggio a vite, inserti VB/VC... angolo del tagliente ut. 107.5°

Utensile destro/sinistro per tornitura esterna con bloccaggio a vite e passaggio refrigerante interno, angolo del tagliente utensile 107.5° per inserti positivi VB... 16 o VC... 16. Adatto per la tornitura longitudinale con spallamento, conicità, copiatura fino a 35° e smussi. Disponibile con attacco PSC (Attacco Poligonale) da C4 a C6. Corpo trattato per una maggiore durata.

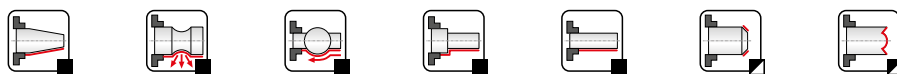
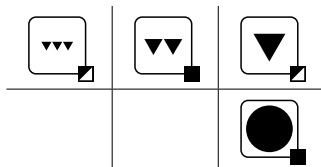
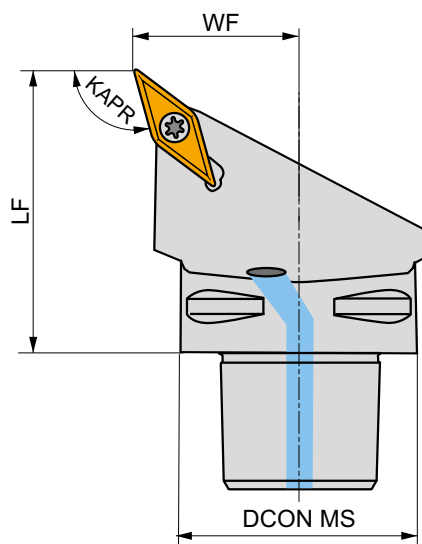
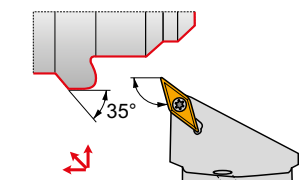

Codice prodotto	DCON MS	WF	LF	KAPR	LAMS	GAMO					
	(mm)	(mm)	(mm)	(°)	(°)	(°)					
R	C4-SVHBR-27050-16	40	27	50	107.5	0	0	✓	0.35	GI017	C-SV16S-1
	C5-SVHBR-35060-16	50	35	60	107.5	0	0	✓	0.64	GI017	C-SV16S-2
	C6-SVHBR-45065-16	63	45	65	107.5	0	0	✓	1.13	GI017	C-SV16S-2
L	C4-SVHBL-27050-16	40	27	50	107.5	0	0	✓	0.35	GI017	C-SV16S-1
	C5-SVHBL-35060-16	50	35	60	107.5	0	0	✓	0.64	GI017	C-SV16S-2
	C6-SVHBL-45065-16	63	45	65	107.5	0	0	✓	1.12	GI017	C-SV16S-2



GI017



VB.. 1604..



VC.. 1604..



C-SV16S-1



US 2001-T15P



3.0



M 3.5



12.1



SVS 270-01



MS 9001



FLAGT15P/3,5



CN 034-01

C-SV16S-2

US 2001-T15P

3.0

M 3.5

12.1

SVS 270-01

MS 9001

FLAGT15P/3,5

CN 034-02



NEW

C.-SVJB(RL) EXT

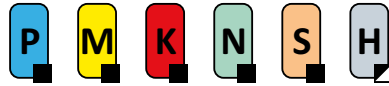

PRAMET

S



Utensile PSC esterno a cambio rapido, bloccaggio a vite, inserti VB/VC... angolo del tagliente ut. 93°

Utensile destro/sinistro per tornitura esterna con bloccaggio a vite e passaggio refrigerante interno, angolo del tagliente utensile 93° per inserti positivi VB...11 o VB...16 e VC...11 e Vc...16. Adatto per la tornitura longitudinale con spallamento, conicità, copiatura fino a 50° e smussi. Disponibile con attacco PSC (Attacco Poligonale) da C3 a C6. Corpo trattato per una maggiore durata.

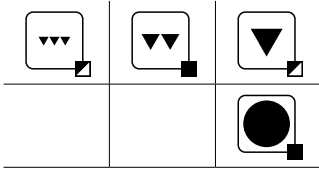
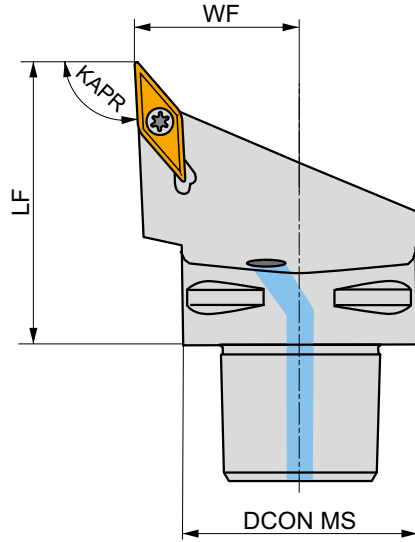
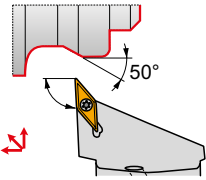

Codice prodotto	DCON MS (mm)	WF (mm)	LF (mm)	KAPR (°)	LAMS (°)	GAMO (°)		kg		
R C3-SVJBR-22040-11-B1	32	22	40	93	0	0	✓	0.17	GI194	C-SV11
C4-SVJBR-27050-11-B1	40	27	50	93	0	0	✓	0.34	GI194	C-SV11
C4-SVJBR-27050-16	40	27	50	93	0	0	✓	0.35	GI017	C-SV16S-1
C5-SVJBR-35060-16	50	35	60	93	0	0	✓	0.63	GI017	C-SV16S-2
C6-SVJBR-45065-16	63	45	65	93	0	0	✓	1.11	GI017	C-SV16S-2
L C4-SVJBL-27050-16	40	27	50	93	0	0	✓	0.35	GI017	C-SV16S-1
C5-SVJBL-35060-16	50	35	60	93	0	0	✓	0.64	GI017	C-SV16S-2
C6-SVJBL-45065-16	63	45	65	93	0	0	✓	1.11	GI017	C-SV16S-2

GI017	VB.. 1604..	VC.. 1604..
GI194	VB.. 1103..	VC.. 1103..

C-SV11	US 2003-T07P	0.8	M 2.5	6.5	-	-	FLAG T07P	CN 034-01
C-SV16S-1	US 2001-T15P	3.0	M 3.5	12.1	SVS 270-01	MS 9001	FLAG T15P/3,5	CN 034-01
C-SV16S-2	US 2001-T15P	3.0	M 3.5	12.1	SVS 270-01	MS 9001	FLAG T15P/3,5	CN 034-02

NEW
C-SVVBN EXT

PRAMET
S

Utensile esterno PSC a cambio rapido, bloccaggio a vite, angolo del tagliente 72,5°, inserti VB/VC..

Utensile esterno di tornitura neutro con fori per refrigerante interno, bloccaggio a vite per inserti VB .. 16 e VC .. 16 positivi. Adatto per tornitura longitudinale esterna senza spallamento, conica, copiatura fino a 72,5 ° e smussi. Attacco a cambio rapido PSC (Polygon Shank Coupling) dimensioni da C4 a C6. Corpo trattato per una maggiore durata dell'utensile.

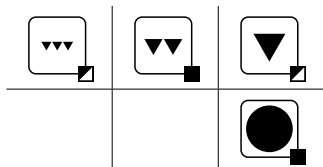
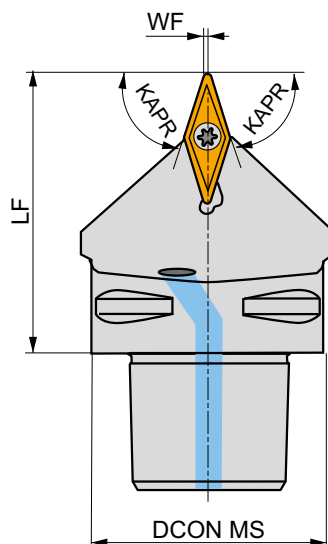
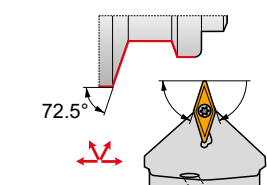

Codice prodotto	DCON MS (mm)	WF (mm)	LF (mm)	KAPR (°)	LAMS (°)	GAMMO (°)		kg		
N C4-SVVBN-00050-16	40	0.6	50	72.5	0	0	✓	0.32	GI017	C-SV16S-1
C5-SVVBN-00060-16	50	0.6	60	72.5	0	0	✓	0.56	GI017	C-SV16S-2
C6-SVVBN-00065-16	63	0.6	65	72.5	0	0	✓	0.99	GI017	C-SV16S-2

GI017	VB.. 1604..	VC.. 1604..

C-SV16S-1	US 2001-T15P	3.0	M 3.5	12.1	SVS 270-01	MS 9001	FLAG T15P/3,5	CN 034-01
C-SV16S-2	US 2001-T15P	3.0	M 3.5	12.1	SVS 270-01	MS 9001	FLAG T15P/3,5	CN 034-02



SVJB(RL) INT

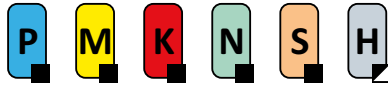

PRAMET

S



Utensile interno, bloccaggio a vite, inserti VB/VC... angolo del tagliente utensile 93°

Bareno destro/sinistro per tornitura interna con bloccaggio a vite e passaggio refrigerante interno, angolo del tagliente utensile 93° per inserti positivi VB...11 o VC...11. Diametro interno minimo tornibile Ø25 mm. Adatto per la copiatura frontale al di sotto di 50°. Disponibile con stelo Ø20 mm e Ø25 mm. Corpo trattato per una maggiore durata.

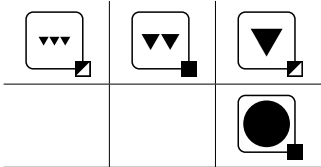
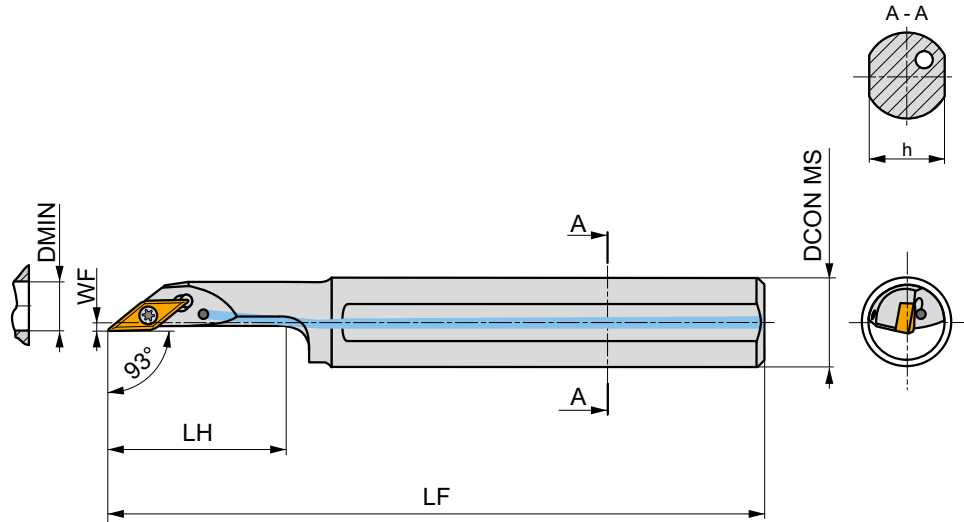
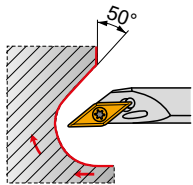

Codice prodotto	DCON MS (mm)	DMIN (mm)	WF (mm)	H (mm)	LF (mm)	LH (mm)	LAMS (°)	GAMO (°)		kg		
R A20R-SVJBR 11	20	25	2	18	200	40	-5	-5	✓	0.44	GI194	S07
A25S-SVJBR 11	25	32	3.5	23	250	50	-5	-5	✓	0.82	GI194	S07
L A20R-SVJBL 11	20	25	2	18	200	40	-5	-5	✓	0.42	GI194	S07
A25S-SVJBL 11	25	32	3.5	23	250	50	-5	-5	✓	0.82	GI194	S07

GI194	VB.. 1103..	VC.. 1103..

S07	US 2506-T07P	0.9	M 2.5	6.3	FLAG T07P



SVQB(C)(RL) INT



PRAMET

S



Utensile interno, bloccaggio a vite, inserti VB/VC... angolo del tagliente utensile 107.5°

Bareno destro/sinistro per tornitura interna con bloccaggio a vite e passaggio refrigerante interno, angolo del tagliente utensile 107.5° per inserti positivi VB.../VC...da 11 a 16. Diametro interno minimo tornibile Ø20 mm. Adatto per un'ampia gamma di applicazioni di tornitura interna. Disponibile con stelo da Ø16 mm a Ø40 mm. Corpo trattato per una maggiore durata.

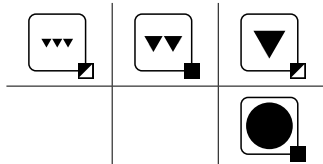
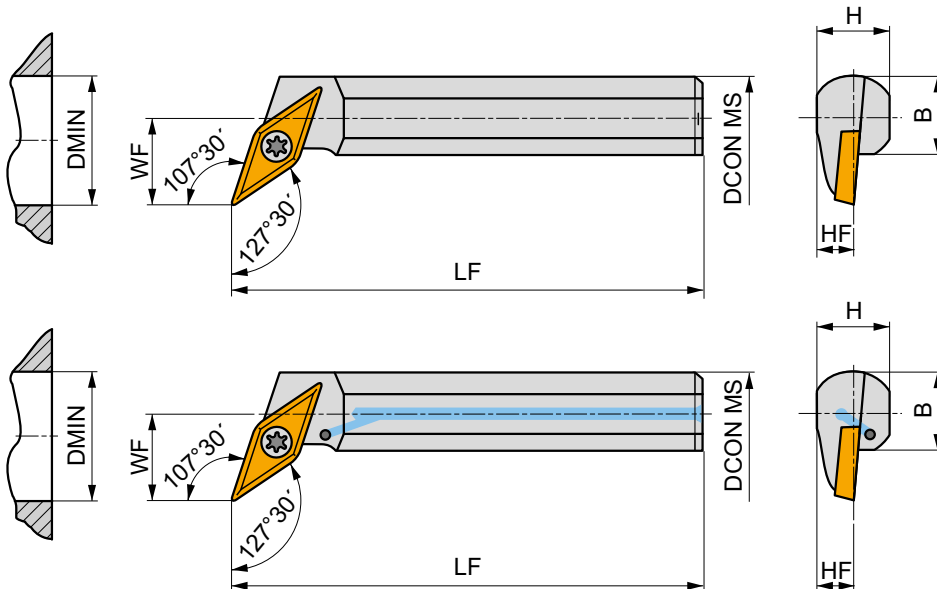
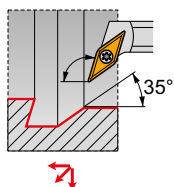

Codice prodotto	DCON MS	DMIN	WF	H	B	LF	LAMS	GAMO					
	(mm)	(mm)	(mm)	(mm)	(mm)	(mm)	(°)	(°)					
R	A16R-SVQBR 11	16	20	11	14.5	15	200	-5	0	✓	0.33	GI194	S01
	A20S-SVQBR 11	20	25	13	18	18.5	250	-4	0	✓	0.58	GI194	S01
	A16R-SVQCR 13	16	21	11	15	15	200	-6	0	✓	0.30	GI211	SV21
	A20S-SVQCR 13	20	25	13	18	18.5	250	-4	0	✓	0.12	GI211	SV21
	S25T-SVQCR 16	25	32	17	23	23	300	-7	0	-	1.10	GI017	S08
	S32U-SVQCR 16	32	40	22	30	30	350	-5	0	-	2.07	GI017	S08
	S40V-SVQCR 16-A	40	50	27	38	38	400	-5	0	-	3.80	GI017	SV10
L	A16R-SVQBL 11	16	20	11	14.5	15	200	-5	0	✓	0.33	GI194	S01
	A20S-SVQBL 11	20	25	13	18	18.5	250	-4	0	✓	0.58	GI194	S01
	A16R-SVQCL 13	16	21	11	15	15	200	-6	0	✓	0.29	GI211	SV21
	A20S-SVQCL 13	20	25	13	18	18.5	250	-4	0	✓	0.54	GI211	SV21
	S25T-SVQCL 16	25	32	17	23	23	300	-7	0	-	1.09	GI017	S08
	S32U-SVQCL 16	32	40	22	30	30	350	-5	0	-	2.07	GI017	S08
	S40V-SVQCL 16-A	40	50	27	38	38	400	-5	0	-	4.10	GI017	SV10

GI017	VB.. 1604..	VC.. 1604..
GI194	VB.. 1103..	VC.. 1103..
GI211	-	VC.. 1303..

S01	US 2506-T07P	0.9	M 2.5	6.3	-	-	FLAGT07P	-
S08	US 3510-T15P	3.0	M 3.5	10.6	-	-	FLAGT15P	-
SV10	US 3512-T15P	3.0	M 3.5	12.6	SVN 160304	MS 3510	FLAGT15P	HXK 3.5
SV21	5513 020-24	1.5	M 3	8.5	-	-	PT-8002	-



SVUB(C)(RL) INT



PRAMET

S



Utensile interno, bloccaggio a vite, inserti VB/VC... angolo del tagliente utensile 93°

Bareno destro/sinistro per tornitura interna con bloccaggio a vite e passaggio refrigerante interno, angolo del tagliente utensile 93° per inserti positivi VB.../VC... da 11 a 16. Diametro interno minimo tornibile Ø20 mm. Adatto per un'ampia gamma di applicazioni di tornitura e copiatura interna al di sotto di 50°. Disponibile con stelo da Ø16 mm a Ø40 mm. Corpo trattato per una maggiore durata.

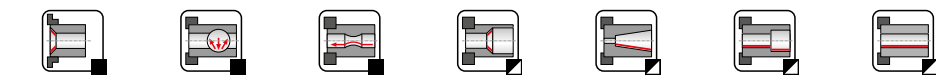
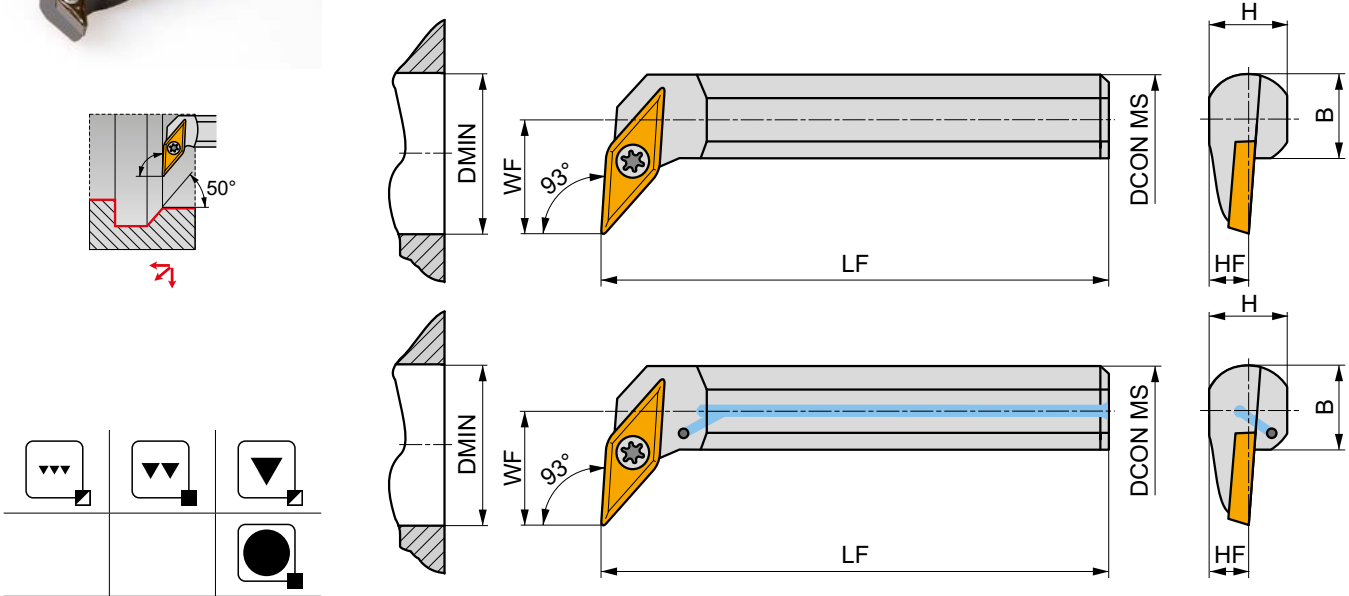

Codice prodotto	DCON MS (mm)	DMIN (mm)	WF (mm)	H (mm)	B (mm)	LF (mm)	LAMS (°)	GAMO (°)				
R A16R-SVUBR 11	16	20	11	14.5	15	200	-5	0	✓	0.34	GI194	S01
A20S-SVUBR 11	20	25	13	18	18.8	250	-4	0	✓	0.58	GI194	S01
A20S-SVUCR 13	20	25	13	19	18.5	250	-4	2	✓	0.40	GI211	SV21
A25T-SVUCR 13	25	32	17	24	23	300	-2	2	✓	0.96	GI211	SV22
A32T-SVUCR 13	32	40	22	30	30	300	-1	2	✓	1.70	GI211	SV22
S25T-SVUCR 16	25	32	17	23	23	300	-7	0	-	1.10	GI017	S08
S32U-SVUCR 16	32	40	22	30	30	350	-5	0	-	2.10	GI017	S08
S40V-SVUCR 16-A	40	50	27	38	38	400	-5	0	-	4.10	GI017	SV10
L A16R-SVUBL 11	16	20	11	14.5	15	200	-5	0	✓	0.34	GI194	S01
A20S-SVUBL 11	20	25	13	18	18.5	250	-4	0	✓	0.58	GI194	S01
A20S-SVUCL 13	20	25	13	19	18.5	250	-4	2	✓	0.32	GI211	SV21
A25T-SVUCL 13	25	32	17	24	23	300	-2	2	✓	0.96	GI211	SV22
A32T-SVUCL 13	32	40	22	30	30	300	-1	2	✓	1.70	GI211	SV22
S25T-SVUCL 16	25	32	17	23	23	300	-7	0	-	1.10	GI017	S08
S32U-SVUCL 16	32	40	22	30	30	350	-5	0	-	2.10	GI017	S08
S40V-SVUCL 16-A	40	50	27	38	38	400	-5	0	-	4.10	GI017	SV10

GI017	VB.. 1604.. VC.. 1604..
GI194	VB.. 1103.. VC.. 1103..
GI211	- VC.. 1303..

S01	US 2506-T07P	0.9	M 2.5	6.3	-	-	FLAG T07P	-
S08	US 3510-T15P	3.0	M 3.5	10.6	-	-	FLAG T15P	-
SV10	US 3512-T15P	3.0	M 3.5	12.6	SVN 160304	MS 3510	FLAG T15P	HXK 3.5
SV21	5513 020-24	1.5	M 3	8.5	-	-	PT-8002	-
SV22	DVF 0573	1.5	M 3	10.3	DAP 0331	DVT 0332	PT-8002	174.1-870

NEW
C.-SVQB(RL) INT

S

Utensile PSC interno a cambio rapido, bloccaggio a vite, inserti VB/VC... angolo del tagliente ut. 107.5°

Utensile destro/sinistro per tornitura interna con bloccaggio a vite e passaggio refrigerante interno, angolo del tagliente utensile 107.5° per inserti positivi VB... 16 o VC... 16. Diametro interno minimo tornibile Ø33 mm. Adatto per un'ampia gamma di applicazioni di tornitura interna. Attacco PSC (Attacco Poligonale) da C4 a C5 con lunghezze diverse. Corpo trattato per una maggiore durata.

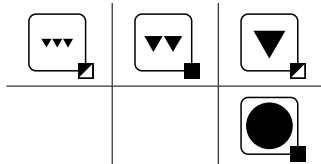
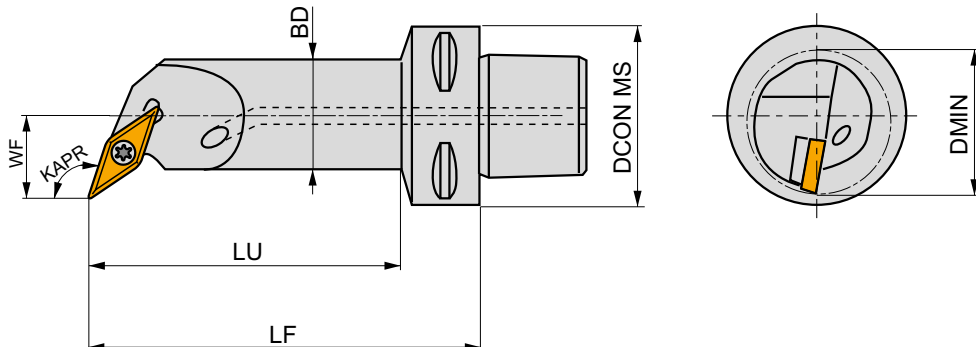
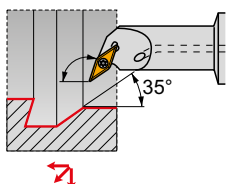

Codice prodotto		DCON MS	DMIN	WF	LF	LU	BD	KAPR	LAMS	GAMO				
		(mm)	(mm)	(mm)	(mm)	(mm)	(mm)	(°)	(°)	(°)				
R	C4-SVQBR-18090-16	40	33	18	90	68	25	107.5	-7.2	0	✓	0.48	GI017	SV16
	C5-SVQBR-18090-16	50	33	18	90	67	25	107.5	-7.2	0	✓	0.67	GI017	SV16
L	C4-SVQBL-18090-16	40	33	18	90	68	25	107.5	-7.2	0	✓	0.48	GI017	SV16
	C5-SVQBL-18090-16	50	33	18	90	67	25	107.5	-7.2	0	✓	0.68	GI017	SV16



GI017



VB.. 1604..



VC.. 1604..



SV16



US 2010-T15P



3.0



M 3.5



10.1



FLAG T15P/3,5



VC

07/ 11/ 13/ 16

INSERTI IN METALLO DURO

VCGT	VCGW	VCGX	VCMT	VCMW
186	189	189	190	191

INSERTI PCD

VCMW PCD
192

ABBINAMENTO DELLA DIMENSIONE CORRETTA (esempio)

Inserto	Portainserito
VCGT 070204E-FF2	SVGCR 1010 M 07

TORNITURA ISO - ESTERNA

SVAC(RL)-DC EXT	SVGC(RL) EXT	SVHB(C)(RL) EXT	SVJB(C)(RL) EXT
90°	90°	107°30'	93°
VC..	VC..	VB, VC..	VB, VC..
13	07	11 16	11 13 16
10×10 25×25	08×08 16×16	16×16 25×25	12×12 32×25
193	194	195	196
186 - 192	186 - 192	168 - 171 186 - 192	168 - 171 186 - 192
SVJC(RL)-DC EXT	SVPB(C)(RL) EXT	SVVB(C)N EXT	SVXB(C)(RL) EXT
93°	117°30'	72°30'	98°
VC..	VB, VC..	VB, VC..	VB, VC..
13	11 16	11 13 16	11 13 16
10×10 25×25	16×16 32×25	12×12 32×25	12×12 32×25
197	198	199	200
186 - 192	168 - 171 186 - 192	168 - 171 186 - 192	168 - 171 186 - 192



VC

07/ 11/ 13/ 16

C.-SVHB(RL) EXT **NEW**

107°30'	VB, VC..
	 16
	$\frac{C4}{C6}$
201	168 – 171 186 – 192

C.-SVJB(RL) EXT **NEW**

93°	VB, VC..
	 11 16
	$\frac{C3}{C6}$
202	168 – 171 186 – 192

C.-SVVBN EXT **NEW**

72°30'	VB, VC..
	 16
	$\frac{C4}{C6}$
203	168 – 171 186 – 192

TORNITURA ISO INTERNA

SVJB(RL) INT

93°	VB, VC..
	 11
	$\frac{25}{32}$
204	168 – 171 186 – 192

SVLC(RL) INT

95°	VC..
	 13
	$\frac{27}{43}$
205	186 – 192

SVQB(C)(RL) INT

107°30'	VB, VC..
	 11 13 16
	$\frac{20}{50}$
206	168 – 171 186 – 192

SVUB(C)(RL) INT

93°	VB, VC..
	 11 13 16
	$\frac{20}{50}$
207	168 – 171 186 – 192

SVXC(RL) INT

113°	VC..
	 07
	$\frac{12,5}{17,5}$
208	186 – 192

SVXC(RL)-E INT

113°	VC..
	 07
	$\frac{12,5}{17,5}$
209	186 – 192

C.-SVQB(C)(RL) INT **NEW**

108°	VB, VC..
	 16
	33
210	168 – 171 186 – 192



VCGT



	IC	D1	L	S
	(mm)	(mm)	(mm)	(mm)
0702	3.970	2.20	6.90	2.38
1102-SF3	6.350	2.80	11.10	2.58
1103	6.350	2.80	11.10	3.18
1103-SF3	6.350	2.80	11.10	3.43
1303	7.940	3.40	13.80	3.18
1303-AL	7.940	3.40	13.80	3.43
1303-SF3	7.940	3.40	13.80	3.43
1604	9.525	4.40	16.60	4.76
1604-SF3	9.525	4.40	16.60	5.01

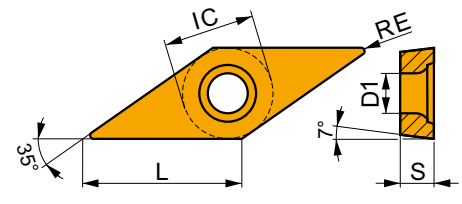

Idoneità e valori iniziali per velocità di taglio (Vc), avanzamento (f) e profondità di taglio (ap). Fare riferimento alla nostra App Machining Calculator per ulteriori calcoli.

Codice prodotto	RE	P			M			K			N			S			H		
		vc	f	ap	vc	f	ap	vc	f	ap	vc	f	ap	vc	f	ap	vc	f	ap
	(mm)	(m/min)	(mm/rev)	(mm)	(m/min)	(mm/rev)	(mm)	(m/min)	(mm/rev)	(mm)	(m/min)	(mm/rev)	(mm)	(m/min)	(mm/rev)	(mm)	(m/min)	(mm/rev)	(mm)

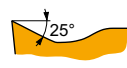

AL geometria con design altamente positivo per operazioni da finitura fino a sgrossatura, da taglio continuo a leggermente interrotto.

VCGT 070202F-AL	HF7	0.2	-	-	-	-	-	-	■	315	0.12	1.0	-	-	-	-	-	-	-
VCGT 110302F-AL	HF7	0.2	-	-	-	-	-	-	■	300	0.12	1.5	-	-	-	-	-	-	-
	T0315	0.2	-	-	-	-	-	-	■	465	0.12	0.8	-	-	-	-	-	-	-
VCGT 110304F-AL	HF7	0.4	-	-	-	-	-	-	■	240	0.24	1.5	-	-	-	-	-	-	-
	T0315	0.4	-	-	-	-	-	-	■	375	0.24	0.8	-	-	-	-	-	-	-
VCGT 130302F-AL	HF7	0.2	-	-	-	-	-	-	■	285	0.12	1.7	-	-	-	-	-	-	-
	T0315	0.2	-	-	-	-	-	-	■	420	0.12	1.7	-	-	-	-	-	-	-
VCGT 130304F-AL	HF7	0.4	-	-	-	-	-	-	■	240	0.24	1.7	-	-	-	-	-	-	-
	T0315	0.4	-	-	-	-	-	-	■	345	0.24	1.7	-	-	-	-	-	-	-
VCGT 130308F-AL	HF7	0.8	-	-	-	-	-	-	■	210	0.48	1.7	-	-	-	-	-	-	-
	T0315	0.8	-	-	-	-	-	-	■	315	0.48	1.7	-	-	-	-	-	-	-
VCGT 160402F-AL	HF7	0.2	-	-	-	-	-	-	■	285	0.12	2.4	-	-	-	-	-	-	-
	T0315	0.2	-	-	-	-	-	-	■	420	0.12	2.4	-	-	-	-	-	-	-
VCGT 160404F-AL	HF7	0.4	-	-	-	-	-	-	■	225	0.24	2.4	-	-	-	-	-	-	-
	T0315	0.4	-	-	-	-	-	-	■	330	0.24	2.4	-	-	-	-	-	-	-
VCGT 160408F-AL	HF7	0.8	-	-	-	-	-	-	■	210	0.48	2.4	-	-	-	-	-	-	-
	T0315	0.8	-	-	-	-	-	-	■	300	0.48	2.4	-	-	-	-	-	-	-
VCGT 160412F-AL	HF7	1.2	-	-	-	-	-	-	■	180	0.72	2.4	-	-	-	-	-	-	-
	T0315	1.2	-	-	-	-	-	-	■	270	0.72	2.4	-	-	-	-	-	-	-

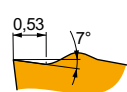

FF2 geometria positiva per operazioni da super finitura fino a finitura, da taglio continuo a leggermente interrotto.

VCGT 070202E-FF2	T8315	0.2	■	150	0.05	0.8	-	-	-	■	140	0.05	0.8	-	-	-	-	-	-
	T8330	0.2	■	145	0.05	0.8	-	-	-	■	135	0.05	0.8	-	-	-	-	-	-
	T8430	0.2	■	190	0.05	0.8	-	-	-	■	155	0.05	0.8	-	-	-	-	-	-
VCGT 070204E-FF2	T8315	0.4	■	125	0.12	0.8	-	-	-	■	115	0.12	0.8	-	-	-	-	-	-
	T8330	0.4	■	120	0.12	0.8	-	-	-	■	110	0.12	0.8	-	-	-	-	-	-
	T8430	0.4	■	145	0.12	0.8	-	-	-	■	120	0.12	0.8	-	-	-	-	-	-
VCGT 130302E-FF2	T5315	0.2	■	250	0.05	1.0	-	-	-	■	235	0.05	1.0	-	-	-	-	-	-
	T7325	0.2	■	165	0.05	1.0	-	-	-	-	-	-	-	-	-	-	-	-	-
	T8330	0.2	■	140	0.05	1.0	-	-	-	■	130	0.05	1.0	-	-	-	-	-	-
	T8430	0.2	■	185	0.05	1.0	-	-	-	■	150	0.05	1.0	-	-	-	-	-	-
	T9315	0.2	■	265	0.05	1.0	-	-	-	■	250	0.05	1.0	-	-	-	-	-	-
	T9325	0.2	■	240	0.05	1.0	-	-	-	■	225	0.05	1.0	-	-	-	-	-	-
	TT010	0.2	■	240	0.05	0.5	-	-	-	-	-	-	-	-	-	-	-	-	-



Idoneità e valori iniziali per velocità di taglio (Vc), avanzamento (f) e profondità di taglio (ap). Fare riferimento alla nostra App Machining Calculator per ulteriori calcoli.

Codice prodotto	RE  (mm)	P			M			K			N			S			H		
		vc (m/min)	f (mm/rev)	ap (mm)	vc (m/min)	f (mm/rev)	ap (mm)	vc (m/min)	f (mm/rev)	ap (mm)	vc (m/min)	f (mm/rev)	ap (mm)	vc (m/min)	f (mm/rev)	ap (mm)	vc (m/min)	f (mm/rev)	ap (mm)

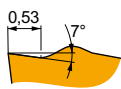

FF2 geometria positiva per operazioni da super finitura fino a finitura, da taglio continuo a leggermente interrotto.

VCGT 130304E-FF2	T5315	0.4	✓	195	0.12	1.0	–	–	–	■	185	0.12	1.0	–	–	–	–	–	–
	T7325	0.4	✓	135	0.12	1.0	–	–	–	–	–	–	–	–	–	–	–	–	–
	T8330	0.4	■	115	0.12	1.0	–	–	–	■	105	0.12	1.0	–	–	–	–	–	–
	T8430	0.4	■	140	0.12	1.0	–	–	–	✓	115	0.12	1.0	–	–	–	–	–	–
	T9315	0.4	■	195	0.12	1.0	–	–	–	✓	185	0.12	1.0	–	–	–	–	–	–
	T9325	0.4	■	175	0.12	1.0	–	–	–	✓	165	0.12	1.0	–	–	–	–	–	–
TT010	0.4	■	245	0.06	0.5	–	–	–	–	–	–	–	–	–	–	–	–	–	
VCGT 130308E-FF2	T7325	0.8	✓	145	0.17	1.0	–	–	–	–	–	–	–	–	–	–	–	–	
	T9315	0.8	■	200	0.17	1.0	–	–	–	✓	190	0.17	1.0	–	–	–	–	–	
	T9325	0.8	■	180	0.17	1.0	–	–	–	✓	170	0.17	1.0	–	–	–	–	–	
	TT010	0.8	■	245	0.10	0.8	–	–	–	–	–	–	–	–	–	–	–	–	

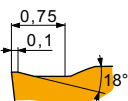

FM2 geometria per operazioni da finitura fino a lavorazioni medie, da taglio continuo a interrotto.

VCGT 130308E-FM2	T8330	0.8	■	125	0.17	1.0	✓	75	0.15	1.0	■	115	0.17	1.0	–	–	–	–	–
	T8430	0.8	■	145	0.17	1.0	✓	80	0.15	1.0	✓	120	0.17	1.0	–	–	–	–	–
	T9325	0.8	■	180	0.17	1.0	✓	105	0.15	1.0	✓	170	0.17	1.0	–	–	–	–	–



NF2 geometria con design positivo per operazioni da finitura e semi grossatura, taglio continuo.

VCGT 130302E-NF2	H07	0.2	–	–	–	✓	60	0.09	1.0	✓	95	0.10	1.0	✓	310	0.12	1.0	■	30	0.07	0.8	–	–	–		
	T6310	0.2	✓	125	0.07	1.0	■	90	0.06	1.0	✓	100	0.07	1.0	✓	375	0.08	1.0	■	35	0.06	0.8	–	–	–	
	T7325	0.2	✓	150	0.07	1.0	■	115	0.06	1.0	–	–	–	–	–	–	–	–	■	45	0.06	0.8	–	–	–	
	T7335	0.2	✓	150	0.07	1.0	■	115	0.06	1.0	–	–	–	–	–	–	–	–	■	45	0.06	0.8	–	–	–	
	T9315	0.2	✓	200	0.10	1.0	–	–	–	✓	190	0.10	1.0	–	–	–	–	–	–	–	–	–	–	–	–	
	T9325	0.2	✓	210	0.07	1.0	■	125	0.06	1.0	✓	195	0.07	1.0	–	–	–	–	–	✓	45	0.06	0.8	–	–	–
	T9335	0.2	✓	155	0.10	1.0	■	90	0.09	1.0	–	–	–	–	–	–	–	–	–	✓	30	0.07	0.8	–	–	–
	TT010	0.2	✓	240	0.05	0.5	✓	140	0.05	0.5	–	–	–	–	–	–	–	–	–	–	–	–	–	–	–	
	VCGT 130304E-NF2	H07	0.4	–	–	–	✓	60	0.11	1.0	✓	95	0.12	1.0	✓	310	0.14	1.0	■	30	0.11	0.8	–	–	–	
		T5315	0.4	✓	195	0.12	1.0	–	–	–	✓	185	0.12	1.0	–	–	–	–	–	–	–	–	–	–	–	
T6310		0.4	✓	115	0.12	1.0	■	80	0.11	1.0	✓	90	0.12	1.0	✓	345	0.14	1.0	■	30	0.11	0.8	–	–	–	
T7325		0.4	✓	135	0.12	1.0	■	105	0.11	1.0	–	–	–	–	–	–	–	–	■	40	0.08	0.8	–	–	–	
T7335		0.4	✓	135	0.12	1.0	■	105	0.11	1.0	–	–	–	–	–	–	–	–	■	40	0.08	0.8	–	–	–	
T9315		0.4	✓	210	0.10	1.0	–	–	–	✓	195	0.10	1.0	–	–	–	–	–	–	–	–	–	–	–	–	
T9325		0.4	✓	175	0.12	1.0	■	105	0.11	1.0	✓	165	0.12	1.0	–	–	–	–	–	✓	35	0.08	0.8	–	–	–
T9335		0.4	✓	150	0.12	1.0	■	90	0.11	1.0	–	–	–	–	–	–	–	–	–	✓	30	0.11	0.8	–	–	–
TT010		0.4	✓	245	0.06	0.5	✓	145	0.06	0.5	–	–	–	–	–	–	–	–	–	–	–	–	–	–	–	
VCGT 130308E-NF2		T5315	0.8	✓	205	0.17	1.0	–	–	–	✓	190	0.17	1.0	–	–	–	–	–	–	–	–	–	–	–	
	T6310	0.8	✓	125	0.17	1.0	■	90	0.15	1.0	✓	100	0.17	1.0	✓	375	0.20	1.0	■	35	0.12	0.8	–	–	–	
	T7325	0.8	✓	145	0.17	1.0	■	110	0.15	1.0	–	–	–	–	–	–	–	–	■	45	0.12	0.8	–	–	–	
	T7335	0.8	✓	140	0.17	1.0	■	105	0.15	1.0	–	–	–	–	–	–	–	–	■	45	0.12	0.8	–	–	–	
	T9315	0.8	✓	200	0.17	1.0	–	–	–	✓	190	0.17	1.0	–	–	–	–	–	–	–	–	–	–	–	–	
	T9325	0.8	✓	180	0.17	1.0	■	105	0.15	1.0	✓	170	0.17	1.0	–	–	–	–	–	✓	40	0.12	0.8	–	–	–
	T9335	0.8	✓	155	0.18	1.0	■	90	0.16	1.0	–	–	–	–	–	–	–	–	–	✓	30	0.16	0.8	–	–	–
	TT010	0.8	✓	245	0.10	0.8	✓	145	0.09	0.8	–	–	–	–	–	–	–	–	–	–	–	–	–	–	–	

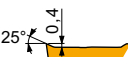

SF2 geometria con design altamente positivo per lavorazioni leggere e finitura, taglio continuo.

VCGT 130301E-SF2	H07	0.1	–	–	–	✓	80	0.05	1.0	–	–	–	✓	405	0.06	1.0	■	40	0.04	0.8	–	–	–
	T6310	0.1	✓	140	0.05	1.0	■	100	0.05	1.0	–	–	–	✓	420	0.06	1.0	■	40	0.04	0.8	–	–



Idoneità e valori iniziali per velocità di taglio (Vc), avanzamento (f) e profondità di taglio (ap). Fare riferimento alla nostra App Machining Calculator per ulteriori calcoli.

Codice prodotto	RE  (mm)	P			M			K			N			S			H		
		vc (m/min)	f (mm/rev)	ap (mm)	vc (m/min)	f (mm/rev)	ap (mm)	vc (m/min)	f (mm/rev)	ap (mm)	vc (m/min)	f (mm/rev)	ap (mm)	vc (m/min)	f (mm/rev)	ap (mm)	vc (m/min)	f (mm/rev)	ap (mm)

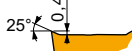

SF2 geometria con design altamente positivo per lavorazioni leggere e finitura, taglio continuo.

VCGT 130302E-SF2	H07	0.2	-	-	-	80	0.05	1.0	-	-	-	405	0.06	1.0	40	0.04	0.8	-	-	-
	HF7	0.2	-	-	-	90	0.05	1.0	-	-	-	450	0.06	1.0	-	-	-	-	-	-
	T6310	0.2	140	0.05	1.0	100	0.05	1.0	-	-	-	420	0.06	1.0	40	0.04	0.8	-	-	-
VCGT 130304E-SF2	H07	0.4	-	-	-	65	0.09	1.0	-	-	-	335	0.12	1.0	30	0.07	0.8	-	-	-
	HF7	0.4	-	-	-	75	0.09	1.0	-	-	-	375	0.12	1.0	-	-	-	-	-	-
	T6310	0.4	125	0.10	1.0	90	0.09	1.0	-	-	-	375	0.12	1.0	35	0.07	0.8	-	-	-
VCGT 130308E-SF2	H07	0.8	-	-	-	75	0.09	1.0	-	-	-	390	0.12	1.0	35	0.08	0.8	-	-	-
	HF7	0.8	-	-	-	85	0.09	1.0	-	-	-	435	0.12	1.0	-	-	-	-	-	-
	T6310	0.8	145	0.10	1.0	100	0.09	1.0	-	-	-	435	0.12	1.0	40	0.08	0.8	-	-	-

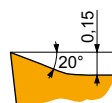

SF3 geometria con design altamente positivo per lavorazioni leggere e finitura, taglio continuo.

VCGT 070202E-SF3	H07	0.2	-	-	-	80	0.05	0.8	130	0.05	0.8	415	0.06	0.8	40	0.04	0.6	-	-	-
	T6310	0.2	145	0.05	0.8	100	0.05	0.8	115	0.05	0.8	435	0.06	0.8	40	0.04	0.6	25	0.15	1.0
VCGT 070204E-SF3	T6310	0.4	125	0.10	0.8	90	0.09	0.8	100	0.10	0.8	375	0.12	0.8	35	0.07	0.6	25	0.15	1.0
VCGT 110201E-SF3	T6310	0.1	140	0.05	0.5	100	0.05	0.5	110	0.05	0.5	420	0.06	0.5	40	0.04	0.4	25	0.15	1.0
VCGT 110202E-SF3	H07	0.2	-	-	-	80	0.05	0.8	130	0.05	0.8	415	0.06	0.8	40	0.04	0.6	-	-	-
	T6310	0.2	145	0.05	0.8	100	0.05	0.8	115	0.05	0.8	435	0.06	0.8	40	0.04	0.6	25	0.15	1.0
	T8315	0.2	150	0.05	0.8	90	0.05	0.8	140	0.05	0.8	450	0.06	0.8	35	0.04	0.6	25	0.15	1.0
VCGT 110204E-SF3	H07	0.4	-	-	-	65	0.09	0.8	105	0.10	0.8	335	0.12	0.8	30	0.07	0.6	-	-	-
	T6310	0.4	125	0.10	0.8	90	0.09	0.8	100	0.10	0.8	375	0.12	0.8	35	0.07	0.6	25	0.15	1.0
	T8315	0.4	135	0.10	0.8	80	0.09	0.8	125	0.10	0.8	405	0.12	0.8	30	0.07	0.6	25	0.15	1.0
VCGT 110301E-SF3	T6310	0.1	140	0.05	0.5	100	0.05	0.5	110	0.05	0.5	420	0.06	0.5	40	0.04	0.4	25	0.15	1.0
VCGT 110302E-SF3	T6310	0.2	145	0.05	0.8	100	0.05	0.8	115	0.05	0.8	435	0.06	0.8	40	0.04	0.6	25	0.15	1.0
VCGT 110304E-SF3	T6310	0.4	125	0.10	0.8	90	0.09	0.8	100	0.10	0.8	375	0.12	0.8	35	0.07	0.6	25	0.15	1.0
VCGT 130302E-SF3	H07	0.2	-	-	-	80	0.05	0.8	130	0.05	0.8	415	0.06	0.8	40	0.04	0.6	-	-	-
	T6310	0.2	145	0.05	0.8	100	0.05	0.8	115	0.05	0.8	435	0.06	0.8	40	0.04	0.6	25	0.15	1.0
	T8315	0.2	150	0.05	0.8	90	0.05	0.8	140	0.05	0.8	450	0.06	0.8	35	0.04	0.6	25	0.15	1.0
VCGT 130304E-SF3	H07	0.4	-	-	-	65	0.09	1.0	105	0.10	1.0	335	0.12	1.0	30	0.07	0.8	-	-	-
	T6310	0.4	125	0.10	1.0	90	0.09	1.0	100	0.10	1.0	375	0.12	1.0	35	0.07	0.8	25	0.15	1.0
	T8315	0.4	130	0.10	1.0	75	0.09	1.0	120	0.10	1.0	390	0.12	1.0	30	0.07	0.8	25	0.15	1.0
VCGT 130308E-SF3	H07	0.8	-	-	-	75	0.09	1.0	120	0.10	1.0	390	0.12	1.0	35	0.08	0.8	-	-	-
	T6310	0.8	145	0.10	1.0	100	0.09	1.0	115	0.10	1.0	435	0.12	1.0	40	0.08	0.8	25	0.15	1.0
	T8315	0.8	155	0.10	1.0	90	0.09	1.0	145	0.10	1.0	465	0.12	1.0	35	0.08	0.8	30	0.15	1.0
VCGT 160402E-SF3	T6310	0.2	145	0.05	0.8	100	0.05	0.8	115	0.05	0.8	435	0.06	0.8	40	0.04	0.6	25	0.15	1.0
VCGT 160404E-SF3	H07	0.4	-	-	-	65	0.09	1.0	105	0.10	1.0	335	0.12	1.0	30	0.07	0.8	-	-	-
	T6310	0.4	125	0.10	1.0	90	0.09	1.0	100	0.10	1.0	375	0.12	1.0	35	0.07	0.8	25	0.15	1.0
	T8315	0.4	130	0.10	1.0	75	0.09	1.0	120	0.10	1.0	390	0.12	1.0	30	0.07	0.8	25	0.15	1.0
VCGT 160408E-SF3	H07	0.8	-	-	-	75	0.09	1.2	120	0.10	1.2	390	0.12	1.2	35	0.08	1.0	-	-	-
	T6310	0.8	145	0.10	1.2	100	0.09	1.2	115	0.10	1.2	435	0.12	1.2	40	0.08	1.0	25	0.15	1.0
	T8315	0.8	155	0.10	1.2	90	0.09	1.2	145	0.10	1.2	465	0.12	1.2	35	0.08	1.0	30	0.15	1.0
VCGT 160412E-SF3	H07	1.2	-	-	-	60	0.18	1.2	95	0.20	1.2	310	0.24	1.2	30	0.14	1.0	-	-	-
	T6310	1.2	125	0.20	1.2	90	0.18	1.2	100	0.20	1.2	375	0.24	1.2	35	0.14	1.0	25	0.15	1.0



VCGW

PRAMET

	IC	D1	L	S
	(mm)	(mm)	(mm)	(mm)
1303	7.940	3.40	13.80	3.18

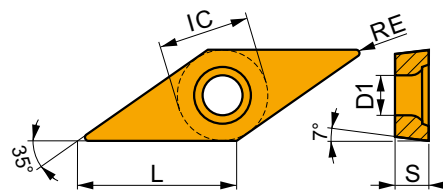

Idoneità e valori iniziali per velocità di taglio (Vc), avanzamento (f) e profondità di taglio (ap). Fare riferimento alla nostra App Machining Calculator per ulteriori calcoli.

Codice prodotto	RE (mm)	P			M			K			N			S			H		
		vc (m/min)	f (mm/rev)	ap (mm)	vc (m/min)	f (mm/rev)	ap (mm)	vc (m/min)	f (mm/rev)	ap (mm)	vc (m/min)	f (mm/rev)	ap (mm)	vc (m/min)	f (mm/rev)	ap (mm)			

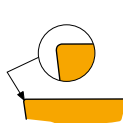

Adatta per operazioni da finitura fino a semi sgrossatura, da taglio continuo a leggermente interrotto.

VCGW 130302	T5305	0.2	–	–	–	–	–	–	–	170	0.08	1.3	–	–	–	–	–	–	–	35	0.15	1.0
VCGW 130304	T5305	0.4	–	–	–	–	–	–	–	165	0.10	1.3	–	–	–	–	–	–	–	35	0.15	1.0
VCGW 130308	T5305	0.8	–	–	–	–	–	–	–	160	0.18	1.3	–	–	–	–	–	–	–	30	0.15	1.0

VCGX

PRAMET

	IC	D1	L	S
	(mm)	(mm)	(mm)	(mm)
1303	7.940	3.40	13.80	3.18

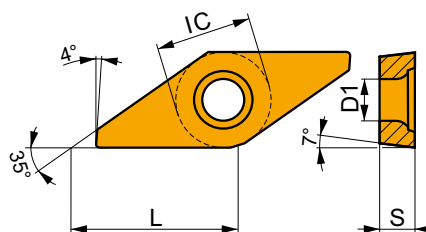

Idoneità e valori iniziali per velocità di taglio (Vc), avanzamento (f) e profondità di taglio (ap). Fare riferimento alla nostra App Machining Calculator per ulteriori calcoli.

Codice prodotto	RE (mm)	P			M			K			N			S			H		
		vc (m/min)	f (mm/rev)	ap (mm)	vc (m/min)	f (mm/rev)	ap (mm)	vc (m/min)	f (mm/rev)	ap (mm)	vc (m/min)	f (mm/rev)	ap (mm)	vc (m/min)	f (mm/rev)	ap (mm)			

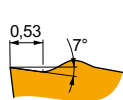

FR-FF2 geometria destra positiva, adatta per operazioni da super finitura fino a finitura, taglio continuo.

VCGX 130300FR-FF2	T6310	0.0	█	140	0.05	1.0	–	–	–	█	110	0.05	1.0	–	–	–	–	–	–	–	–	–
	T8315	0.0	█	150	0.05	1.0	–	–	–	█	140	0.05	1.0	–	–	–	–	–	–	–	–	–
	TT010	0.0	█	240	0.05	0.5	–	–	–	–	–	–	–	–	–	–	–	–	–	–	–	–
VCGX 130301FR-FF2	T6310	0.1	█	140	0.05	1.0	–	–	–	█	110	0.05	1.0	–	–	–	–	–	–	–	–	–
	T8315	0.1	█	150	0.05	1.0	–	–	–	█	140	0.05	1.0	–	–	–	–	–	–	–	–	–
	TT010	0.1	█	240	0.05	0.5	–	–	–	–	–	–	–	–	–	–	–	–	–	–	–	–



Idoneità e valori iniziali per velocità di taglio (Vc), avanzamento (f) e profondità di taglio (ap). Fare riferimento alla nostra App Machining Calculator per ulteriori calcoli.

Codice prodotto	RE (mm)	P			M			K			N			S			H		
		vc (m/min)	f (mm/rev)	ap (mm)	vc (m/min)	f (mm/rev)	ap (mm)	vc (m/min)	f (mm/rev)	ap (mm)	vc (m/min)	f (mm/rev)	ap (mm)	vc (m/min)	f (mm/rev)	ap (mm)	vc (m/min)	f (mm/rev)	ap (mm)

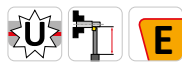
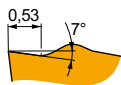

FL-FF2 geometria positiva sinistra per operazioni da super finitura fino a finitura, taglio continuo.

VCGX 130300FL-FF2	T6310	0.0	140	0.05	1.0	—	—	—	110	0.05	1.0	—	—	—	—	—	—	—
	T8315	0.0	150	0.05	1.0	—	—	—	140	0.05	1.0	—	—	—	—	—	—	—
	TT010	0.0	240	0.05	0.5	—	—	—	—	—	—	—	—	—	—	—	—	—
VCGX 130301FL-FF2	T6310	0.1	140	0.05	1.0	—	—	—	110	0.05	1.0	—	—	—	—	—	—	—
	T8315	0.1	150	0.05	1.0	—	—	—	140	0.05	1.0	—	—	—	—	—	—	—

VCMT



	IC (mm)	D1 (mm)	L (mm)	S (mm)
1103	6.350	2.80	11.10	3.18
1604	9.525	4.40	16.60	4.76

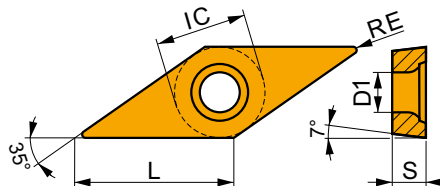

Idoneità e valori iniziali per velocità di taglio (Vc), avanzamento (f) e profondità di taglio (ap). Fare riferimento alla nostra App Machining Calculator per ulteriori calcoli.

Codice prodotto	RE (mm)	P			M			K			N			S			H		
		vc (m/min)	f (mm/rev)	ap (mm)	vc (m/min)	f (mm/rev)	ap (mm)	vc (m/min)	f (mm/rev)	ap (mm)	vc (m/min)	f (mm/rev)	ap (mm)	vc (m/min)	f (mm/rev)	ap (mm)	vc (m/min)	f (mm/rev)	ap (mm)

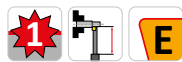
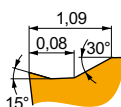

FM geometria per operazioni da finitura fino a semi sgrossatura, da taglio continuo a leggermente interrotto.

VCMT 160404E-FM	T7325	0.4	125	0.19	1.2	95	0.17	1.2	—	—	—	—	—	—	—	—	—	—
	T8330	0.4	130	0.12	1.2	75	0.11	1.2	120	0.12	1.2	390	0.14	1.2	—	—	—	—
	T8430	0.4	150	0.12	1.2	80	0.11	1.2	125	0.12	1.2	420	0.14	1.2	—	—	—	—
	T9315	0.4	210	0.12	1.2	—	—	—	195	0.12	1.2	—	—	—	—	—	—	—
	T9325	0.4	155	0.19	1.2	90	0.17	1.2	145	0.19	1.2	—	—	—	—	—	—	—
VCMT 160408E-FM	T7325	0.8	155	0.17	1.2	120	0.15	1.2	—	—	—	—	—	—	—	—	—	—
	T8330	0.8	135	0.17	1.2	80	0.15	1.2	125	0.17	1.2	405	0.20	1.2	—	—	—	—
	T8430	0.8	155	0.17	1.2	85	0.15	1.2	130	0.17	1.2	435	0.20	1.2	—	—	—	—
	T9315	0.8	220	0.17	1.2	—	—	—	205	0.17	1.2	—	—	—	—	—	—	—
	T9325	0.8	195	0.17	1.2	115	0.15	1.2	185	0.17	1.2	—	—	—	—	—	—	—

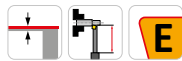
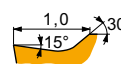

UR geometria per lavorazioni leggere e finitura, da taglio continuo a leggermente interrotto.

VCMT 110304E-UR	T7325	0.4	110	0.19	0.8	85	0.17	0.8	—	—	—	—	—	—	—	—	—	—
	T8330	0.4	110	0.12	0.8	65	0.11	0.8	100	0.12	0.8	—	—	—	—	—	—	—
	T8430	0.4	135	0.12	0.8	75	0.11	0.8	110	0.12	0.8	—	—	—	—	—	—	—
	T9315	0.4	190	0.12	0.8	—	—	—	180	0.12	0.8	—	—	—	—	—	—	—
	T9325	0.4	140	0.19	0.8	80	0.17	0.8	130	0.19	0.8	—	—	—	—	—	—	—
VCMT 110308E-UR	T7325	0.8	140	0.17	0.8	105	0.15	0.8	—	—	—	—	—	—	—	—	—	—
	T8330	0.8	125	0.17	0.8	75	0.15	0.8	115	0.17	0.8	—	—	—	—	—	—	—
	T8430	0.8	140	0.17	0.8	75	0.15	0.8	115	0.17	0.8	—	—	—	—	—	—	—
	T9315	0.8	195	0.17	0.8	—	—	—	185	0.17	0.8	—	—	—	—	—	—	—
	T9325	0.8	175	0.17	0.8	105	0.15	0.8	165	0.17	0.8	—	—	—	—	—	—	—



Idoneità e valori iniziali per velocità di taglio (Vc), avanzamento (f) e profondità di taglio (ap). Fare riferimento alla nostra App Machining Calculator per ulteriori calcoli.

Codice prodotto	RE (mm)	P			M			K			N			S			H		
		vc (m/min)	f (mm/rev)	ap (mm)	vc (m/min)	f (mm/rev)	ap (mm)	vc (m/min)	f (mm/rev)	ap (mm)	vc (m/min)	f (mm/rev)	ap (mm)	vc (m/min)	f (mm/rev)	ap (mm)	vc (m/min)	f (mm/rev)	ap (mm)

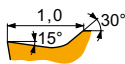
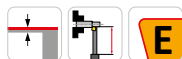

UR geometria per lavorazioni leggere e finitura, da taglio continuo a leggermente interrotto.

VCMT 160404E-UR	T7325	0.4	110	0.19	1.2	85	0.17	1.2	-	-	-	-	-	-	-	-	-	-	
	T8330	0.4	110	0.12	1.2	65	0.11	1.2	100	0.12	1.2	-	-	-	-	-	-	-	
	T8430	0.4	130	0.12	1.2	70	0.11	1.2	105	0.12	1.2	-	-	-	-	-	-	-	
	T9315	0.4	180	0.12	1.2	-	-	-	170	0.12	1.2	-	-	-	-	-	-	-	-
	T9325	0.4	135	0.19	1.2	80	0.17	1.2	125	0.19	1.2	-	-	-	-	-	-	-	
VCMT 160408E-UR	T7325	0.8	135	0.17	1.2	105	0.15	1.2	-	-	-	-	-	-	-	-	-	-	
	T8330	0.8	115	0.17	1.2	65	0.15	1.2	105	0.17	1.2	-	-	-	-	-	-	-	
	T8430	0.8	135	0.17	1.2	75	0.15	1.2	110	0.17	1.2	-	-	-	-	-	-	-	
	T9315	0.8	190	0.17	1.2	-	-	-	180	0.17	1.2	-	-	-	-	-	-	-	
	T9325	0.8	170	0.17	1.2	100	0.15	1.2	160	0.17	1.2	-	-	-	-	-	-	-	

VCMW



	IC (mm)	D1 (mm)	L (mm)	S (mm)
1103	6.350	2.80	11.10	3.18
1604	9.525	4.40	16.60	4.76

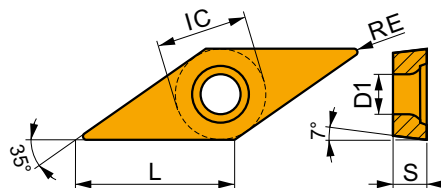

Idoneità e valori iniziali per velocità di taglio (Vc), avanzamento (f) e profondità di taglio (ap). Fare riferimento alla nostra App Machining Calculator per ulteriori calcoli.

Codice prodotto	RE (mm)	P			M			K			N			S			H		
		vc (m/min)	f (mm/rev)	ap (mm)	vc (m/min)	f (mm/rev)	ap (mm)	vc (m/min)	f (mm/rev)	ap (mm)	vc (m/min)	f (mm/rev)	ap (mm)	vc (m/min)	f (mm/rev)	ap (mm)	vc (m/min)	f (mm/rev)	ap (mm)

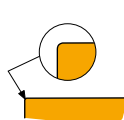

Adatta per operazioni da finitura fino a semi sgrossatura, da taglio continuo a leggermente interrotto.

VCMW 110302	T5305	0.2	-	-	-	-	-	-	170	0.08	1.2	-	-	-	-	-	35	0.15	1.0
	T5315	0.2	-	-	-	-	-	-	145	0.08	1.2	-	-	-	-	-	30	0.15	1.0
	T6310	0.2	-	-	-	-	-	-	70	0.08	1.2	-	-	-	-	-	15	0.15	1.0
VCMW 110304	T5305	0.4	-	-	-	-	-	-	165	0.10	1.2	-	-	-	-	-	35	0.15	1.0
	T5315	0.4	-	-	-	-	-	-	145	0.10	1.2	-	-	-	-	-	30	0.15	1.0
	T6310	0.4	-	-	-	-	-	-	70	0.10	1.2	-	-	-	-	-	15	0.15	1.0
VCMW 160404	T5305	0.4	-	-	-	-	-	-	165	0.10	1.5	-	-	-	-	-	35	0.15	1.0
	T5315	0.4	-	-	-	-	-	-	140	0.10	1.5	-	-	-	-	-	30	0.15	1.0
	T6310	0.4	-	-	-	-	-	-	70	0.10	1.5	-	-	-	-	-	15	0.15	1.0
VCMW 160408	T5305	0.8	-	-	-	-	-	-	155	0.18	1.5	-	-	-	-	-	30	0.15	1.0
	T5315	0.8	-	-	-	-	-	-	135	0.18	1.5	-	-	-	-	-	25	0.15	1.0
	T6310	0.8	-	-	-	-	-	-	70	0.18	1.5	-	-	-	-	-	15	0.15	1.0



VCMW PCD



	IC	D1	L	S
	(mm)	(mm)	(mm)	(mm)
1604	9.525	4.40	16.60	4.76

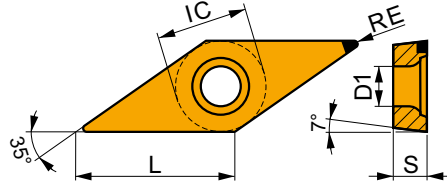

Idoneità e valori iniziali per velocità di taglio (Vc), avanzamento (f) e profondità di taglio (ap). Fare riferimento alla nostra App Machining Calculator per ulteriori calcoli.

Codice prodotto	RE (mm)	P			M			K			N			S			H		
		vc (m/min)	f (mm/rev)	ap (mm)	vc (m/min)	f (mm/rev)	ap (mm)	vc (m/min)	f (mm/rev)	ap (mm)	vc (m/min)	f (mm/rev)	ap (mm)	vc (m/min)	f (mm/rev)	ap (mm)	vc (m/min)	f (mm/rev)	ap (mm)

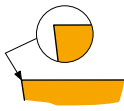

Punta in PCD per operazioni da finitura fino a semi sgrossatura, per elevate velocità e condizioni stabili.

VCMW 160404FN	PD1	0.4	-	-	-	-	-	-	-	900	0.12	0.5	-	-	-	-	-	-
VCMW 160408FN	PD1	0.8	-	-	-	-	-	-	-	1050	0.12	1.0	-	-	-	-	-	-



SVAC(RL)-DC EXT



PRAMET

S



Utensile esterno per fantina mobile, bloccaggio a vite, inserti VCGX 13 angolo del tagliente ut. 90°

Utensile di tornitura esterna per fantina mobile destro/sinistro con bloccaggio a vite, angolo del tagliente utensile 90° per inserto positivo VCGX 13. Adatto per operazioni di sfacciatura e tornitura longitudinale con spallamento, copiatura fino a 53°, conicità e smussi. Disponibile con stelo da 10x10 a 25x25 mm. Corpo trattato per una maggiore durata.

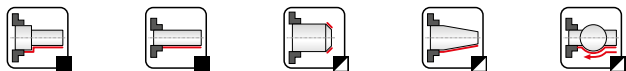
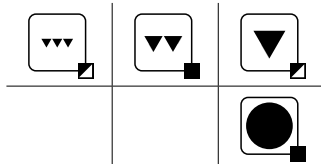
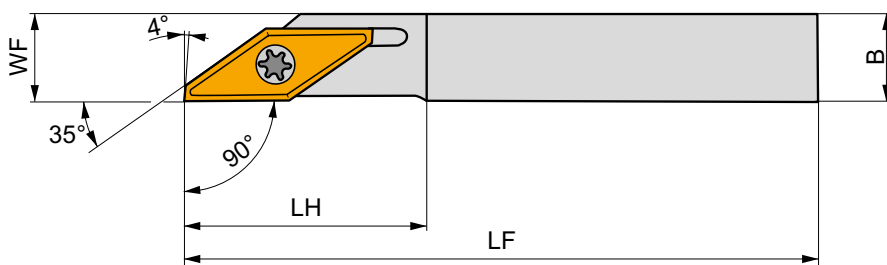
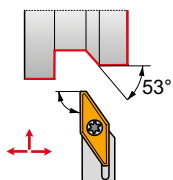

Codice prodotto	H (mm)	B (mm)	HF (mm)	WF (mm)	LF (mm)	LH (mm)	LAMS (°)	GAMO (°)	kg	GI222	SV20	
R	SVACR 1010 L 13-DC	10	10	10	10	140	25	0	0	0.12	GI222	SV20
	SVACR 1212 L 13-DC	12	12	12	12	140	25	0	0	0.17	GI222	SV20
	SVACR 1616 M 13-DC	16	16	16	16	150	25	0	0	0.29	GI222	SV20
	SVACR 2020 M 13-DC	20	20	20	20	150	25	0	0	0.46	GI222	SV20
	SVACR 2525 M 13-DC	25	25	25	25	150	25	0	0	0.67	GI222	SV20
L	SVACL 1010 L 13-DC	10	10	10	10	140	25	0	0	0.10	GI222	SV20
	SVACL 1212 L 13-DC	12	12	12	12	140	25	0	0	0.19	GI222	SV20
	SVACL 1616 M 13-DC	16	16	16	16	150	25	0	0	0.29	GI222	SV20
	SVACL 2020 M 13-DC	20	20	20	20	150	25	0	0	0.43	GI222	SV20
	SVACL 2525 M 13-DC	25	25	25	25	150	25	0	0	0.67	GI222	SV20



GI222



VCGX 1303..



SV20



5513 020-24



1.5



M 3



8.5



PT-8002



SVG(CR) EXT



PRAMET

S



Utensile esterno, bloccaggio a vite, inserti VC... angolo del tagliente utensile 90°

Utensile di tornitura esterna destro/sinistro con bloccaggio a vite, angolo del tagliente utensile 90° per inserto positivo VC...07. Adatto per operazioni di tornitura longitudinale con spallamento, copiatura fino a 53°, conicità e smussi. Disponibile con stelo da 08x08 a 16x16 mm. Corpo trattato per una maggiore durata.

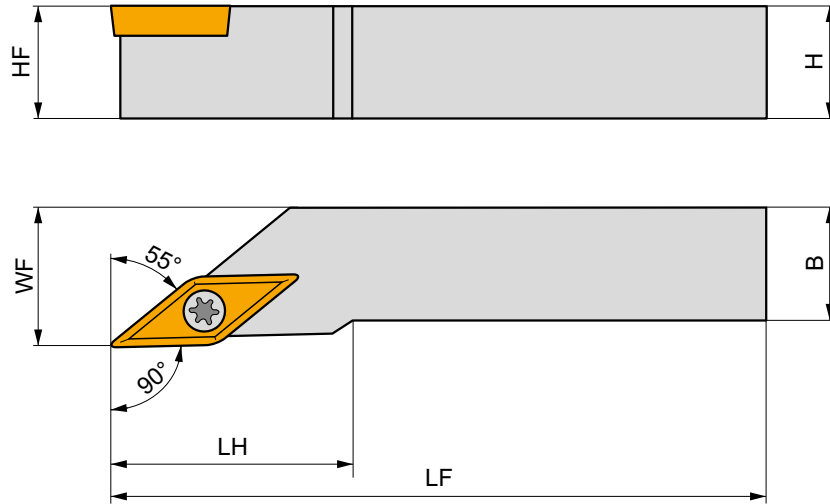
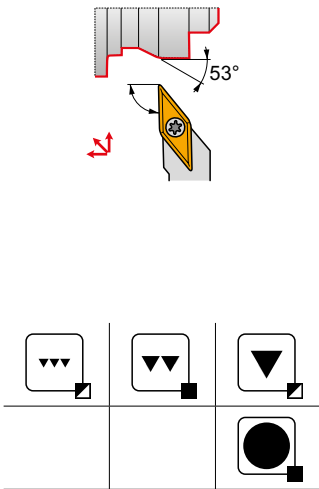

Codice prodotto	H	B	HF	WF	LF	LH	LAMS	GAMO	kg		
	(mm)	(mm)	(mm)	(mm)	(mm)	(mm)	(°)	(°)			
R SVGCR 0808 K 07	8	8	8	8.5	125	15	0	0	0.07	GI234	SV23
SVGCR 1010 M 07	10	10	10	10.5	150	15	0	0	0.13	GI234	SV23
SVGCR 1212 M 07	12	12	12	12.5	150	18	0	0	0.17	GI234	SV23
SVGCR 1616 P 07	16	16	16	16.3	170	23	0	0	0.33	GI234	SV23
L SVGCL 0808 K 07	8	8	8	8.5	125	15	0	0	0.07	GI234	SV23
SVGCL 1010 M 07	10	10	10	10.5	150	15	0	0	0.13	GI234	SV23
SVGCL 1212 M 07	12	12	12	12.5	150	18	0	0	0.17	GI234	SV23
SVGCL 1616 P 07	16	16	16	16.3	170	23	0	0	0.33	GI234	SV23

GI234	VC.. 0702..

SV23	DVF 3584	0.6	M 2	5.5	DMD 1650



SVHB(C)(RL) EXT



Utensile esterno, bloccaggio a vite, inserti VB/VC... angolo del tagliente utensile 107.5°

Utensile di tornitura esterna destro/sinistro con bloccaggio a vite, angolo del tagliente utensile 107.5° per inserti positivi VB...11 o 16 e VC...11 o 16. Adatto per operazioni di sfacciatura, tornitura longitudinale con spallamento, copiatura frontale e longitudinale fino a 35°, conicità e smussi. Disponibile con stelo da 16x16 a 25x25 mm. Corpo trattato per una maggiore durata.

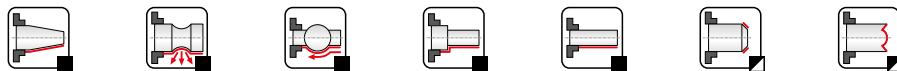
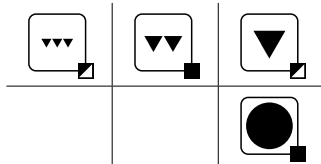
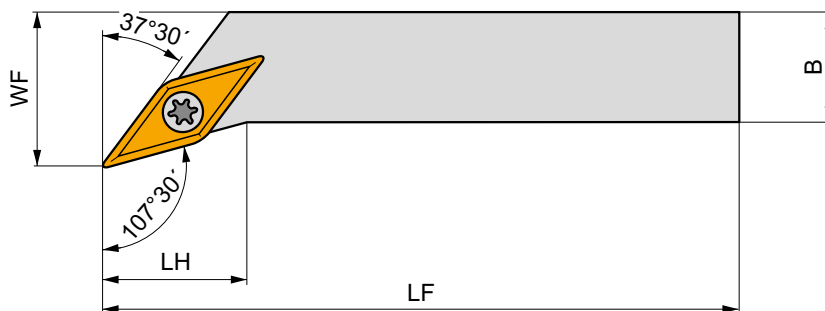
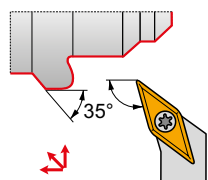

Codice prodotto	H (mm)	B (mm)	HF (mm)	WF (mm)	LF (mm)	LH (mm)	LAMS (°)	GAMO (°)	kg		
R SVHBR 1616 H 11	16	16	16	20	100	14	0	0	0.21	GI194	S01
SVHCR 2020 K 16-M-A	20	20	20	25	125	20	0	0	0.40	GI017	SV10
SVHCR 2525 M 16-M-A	25	25	25	32	150	20	0	0	0.68	GI017	SV10
L SVHBL 1616 H 11	16	16	16	20	100	14	0	0	0.19	GI194	S01
SVHCL 2020 K 16-M-A	20	20	20	25	125	20	0	0	0.40	GI017	SV10
SVHCL 2525 M 16-M-A	25	25	25	32	150	20	0	0	0.07	GI017	SV10

GI017	VB.. 1604.. VC.. 1604..
GI194	VB.. 1103.. VC.. 1103..

S01	US 2506-T07P	0.9	M 2.5	6.3	—	—	FLAGT07P	—
SV10	US 3512-T15P	3.0	M 3.5	12.6	SVN 160304	MS 3510	FLAGT15P	HXK 3.5



SVJB(C)(RL) EXT



PRAMET

S



Utensile esterno, bloccaggio a vite, inserti VB/VC... angolo del tagliente utensile 93°

Utensile di tornitura esterna destro/sinistro con bloccaggio a vite, angolo del tagliente utensile 93° per inserti positivi VB...11 o 16 e VC...11, 13 o 16. Adatto per operazioni di tornitura longitudinale con spallamento, copiatura fino a 50°, conicità e smussi. Disponibile con stelo da 12x12 a 32x25 mm. Corpo trattato per una maggiore durata.

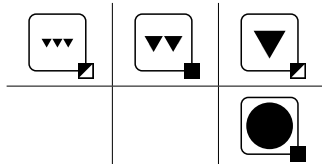
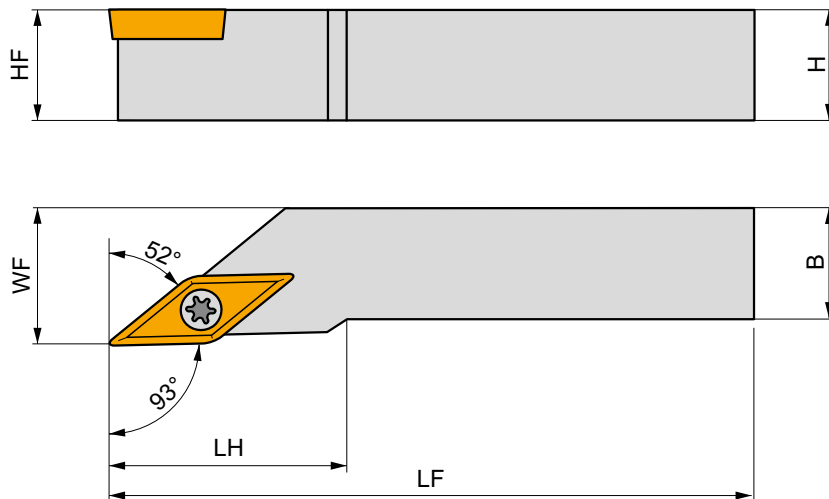
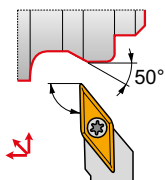

Codice prodotto	H	B	HF	WF	LF	LH	LAMS	GAMO	kg	Icona 1	Icona 2
	(mm)	(mm)	(mm)	(mm)	(mm)	(mm)	(°)	(°)			
R SVJBR 1212 F 11	12	12	12	16	80	20	0	0	0.09	GI194	S01
SVJBR 1616 H 11	16	16	16	20	100	20	0	0	0.20	GI194	S01
SVJCR 1212 N 13	12	12	12	16	160	27	0	0	0.19	GI211	SV21
SVJCR 1616 H 13	16	16	16	20	100	30	0	0	0.20	GI211	SV21
SVJCR 2020 K 13	20	20	20	25	125	30	0	0	0.37	GI211	SV22
SVJCR 2525 M 13	25	25	25	32	150	30	0	0	0.67	GI211	SV22
SVJCR 2020 K 16-M-A	20	20	20	25	125	28	0	0	0.35	GI017	SV10
SVJCR 2525 M 16-M-A	25	25	25	32	150	32	0	0	0.68	GI017	SV10
SVJCR 3225 P 16-M-A	32	25	32	32	170	32	0	0	0.99	GI017	SV10
L SVJBL 1212 F 11	12	12	12	16	80	20	0	0	0.09	GI194	S01
SVJBL 1616 H 11	16	16	16	20	100	20	0	0	0.19	GI194	S01
SVJCL 1212 N 13	12	12	12	16	160	27	0	0	0.19	GI211	SV21
SVJCL 1616 H 13	16	16	16	20	100	30	0	0	0.20	GI211	SV21
SVJCL 2020 K 13	20	20	20	25	125	30	0	0	0.37	GI211	SV22
SVJCL 2525 M 13	25	25	25	32	150	30	0	0	0.67	GI211	SV22
SVJCL 2020 K 16-M-A	20	20	20	25	125	28	0	0	0.40	GI017	SV10
SVJCL 2525 M 16-M-A	25	25	25	32	150	32	0	0	0.70	GI017	SV10
SVJCL 3225 P 16-M-A	32	25	32	32	170	32	0	0	0.99	GI017	SV10

Icona	Icona	Icona
GI017	VB.. 1604..	VC.. 1604..
GI194	VB.. 1103..	VC.. 1103..
GI211	-	VC.. 1303..

Icona	Icona	Icona	Icona	Icona	Icona	Icona	Icona	Icona
S01	US 2506-T07P	0.9	M 2.5	6.3	-	-	FLAG T07P	-
SV10	US 3512-T15P	3.0	M 3.5	12.6	SVN 160304	MS 3510	FLAG T15P	HXK 3.5
SV21	5513 020-24	1.5	M 3	8.5	-	-	PT-8002	-
SV22	DVF 0573	1.5	M 3	10.3	DAP 0331	DVT 0332	PT-8002	174.1-870



SVJC(RL)-DC EXT



Utensile esterno per fantina mobile, bloccaggio a vite, inserti VCGX 13 angolo del tagliente ut. 93°

Utensile di tornitura esterna per fantina mobile destro/sinistro con bloccaggio a vite, angolo del tagliente utensile 93° per inserto positivo VCGX 13. Adatto per operazioni di sfacciatura e tornitura longitudinale con spallamento, copiatura fino a 50°, conicità e smussi. Disponibile con stelo da 10x10 a 25x25 mm. Corpo trattato per una maggiore durata.

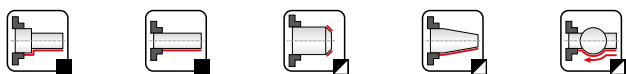
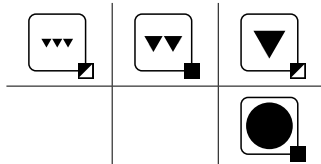
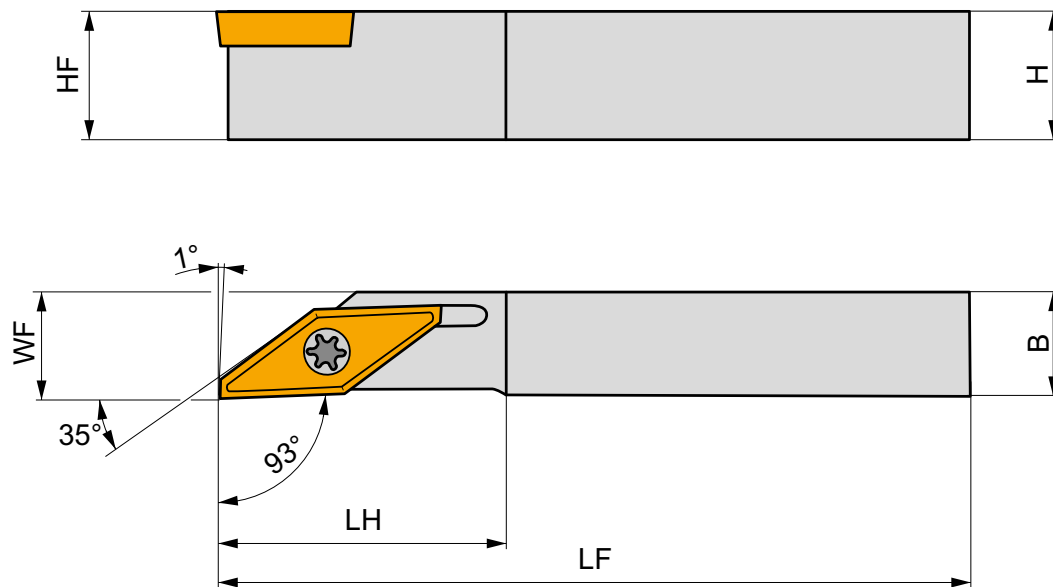
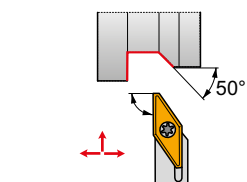

Codice prodotto	H	B	HF	WF	LF	LH	LAMS	GAMO	kg	G122	SV20	
	(mm)	(mm)	(mm)	(mm)	(mm)	(mm)	(°)	(°)				
R	SVJCR 1010 L 13-DC	10	10	10	0	140	25	0	0	0.12	G122	SV20
	SVJCR 1212 L 13-DC	12	12	12	0	140	25	0	0	0.17	G122	SV20
	SVJCR 1616 M 13-DC	16	16	16	0	150	25	0	0	0.29	G122	SV20
	SVJCR 2020 M 13-DC	20	20	20	0	150	25	0	0	0.45	G122	SV20
	SVJCR 2525 M 13-DC	25	25	25	0	150	25	0	0	0.68	G122	SV20
L	SVJCL 1010 L 13-DC	10	10	10	0	140	25	0	0	0.12	G122	SV20
	SVJCL 1212 L 13-DC	12	12	12	0	140	25	0	0	0.17	G122	SV20
	SVJCL 1616 M 13-DC	16	16	16	0	150	25	0	0	0.30	G122	SV20
	SVJCL 2020 M 13-DC	20	20	20	0	150	25	0	0	0.47	G122	SV20
	SVJCL 2525 M 13-DC	25	25	25	0	150	25	0	0	0.69	G122	SV20



G122



VCGX 1303..



SV20



5513 020-24



1.5



M 3



8.5



PT-8002



SVPB(C)(RL) EXT



PRAMET

S

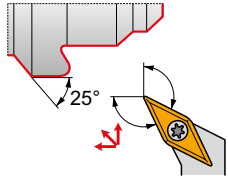

Utensile esterno, bloccaggio a vite, inserti VB/VC... angolo del tagliente utensile 117.5°

Utensile di tornitura esterna destro/sinistro con bloccaggio a vite, angolo del tagliente utensile 117.5° per inserti positivi VB...11 o 16 e VC...11 o 16. Adatto per operazioni di sfacciatura, tornitura longitudinale con spallamento, copiatura frontale fino a 25°, conicità e smussi. Disponibile con stelo da 16x16 a 32x25 mm. Corpo trattato per una maggiore durata.

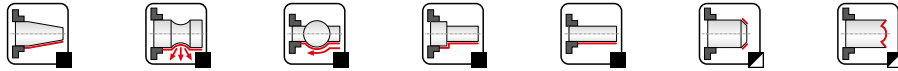
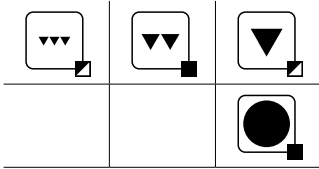
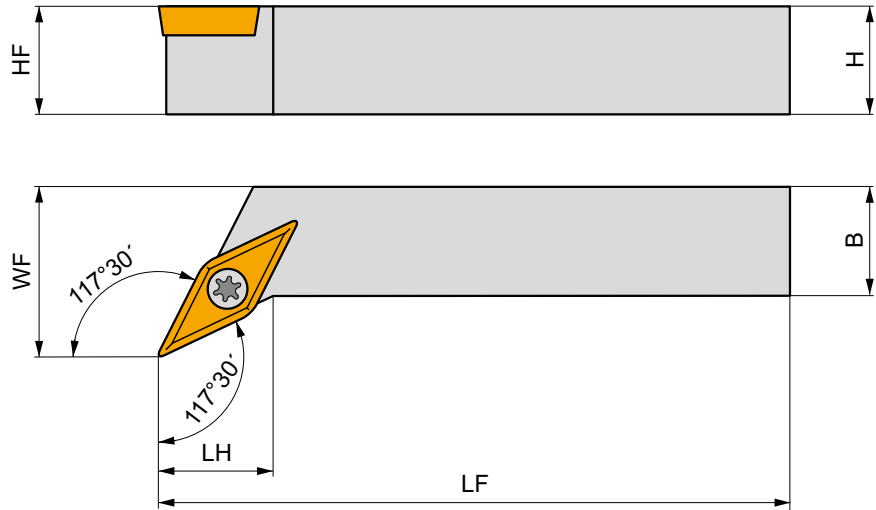

Codice prodotto	H	B	HF	WF	LF	LH	LAMS	GAMO	kg	Icona 1	Icona 2
	(mm)	(mm)	(mm)	(mm)	(mm)	(mm)	(°)	(°)			
R SVPBR 1616 H 11	16	16	16	20	100	12	0	0	0.20	GI194	S01
SVPBR 2020 K 11	20	20	20	25	125	12	0	0	0.41	GI194	S01
SVPCR 2020 K 16-M-A	20	20	20	25	125	20	0	0	0.40	GI017	SV10
SVPCR 2525 M 16-M-A	25	25	25	32	150	25	0	0	0.75	GI017	SV10
SVPCR 3225 P 16-M-A	32	25	32	32	170	25	0	0	1.10	GI017	SV10
L SVPBL 1616 H 11	16	16	16	20	100	12	0	0	0.20	GI194	S01
SVPBL 2020 K 11	20	20	20	25	125	12	0	0	0.39	GI194	S01
SVPCL 2020 K 16-M-A	20	20	20	25	125	20	0	0	0.70	GI017	SV10
SVPCL 2525 M 16-M-A	25	25	25	32	150	25	0	0	0.70	GI017	SV10
SVPCL 3225 P 16-M-A	32	25	32	32	170	25	0	0	1.10	GI017	SV10

Icona	Icona	Icona
GI017	VB.. 1604..	VC.. 1604..
GI194	VB.. 1103..	VC.. 1103..

Icona	Icona	Icona	Icona	Icona	Icona	Icona	Icona	Icona
S01	US 2506-T07P	0.9	M 2.5	6.3	-	-	FLAG T07P	-
SV10	US 3512-T15P	3.0	M 3.5	12.6	SVN 160304	MS 3510	FLAG T15P	HXK 3.5



SVVB(C)N EXT



Utensile esterno, bloccaggio a vite, angolo del tagliente utensile 72,5°, inserti VB/VC..

Utensile esterno di tornitura, neutro, bloccaggio a vite per inserti positivi VB .. 11 o 16 e VC .. da 11 fino a 16. Adatto per tornitura longitudinale esterna senza spallamento, tornitura conica, a copiare fino a 72,5° e smussi. Disponibile con dimensioni stelo da 12x12 fino a 32x25 mm. Corpo trattato per una maggiore durata dell'utensile.

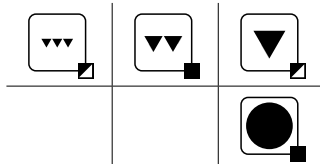
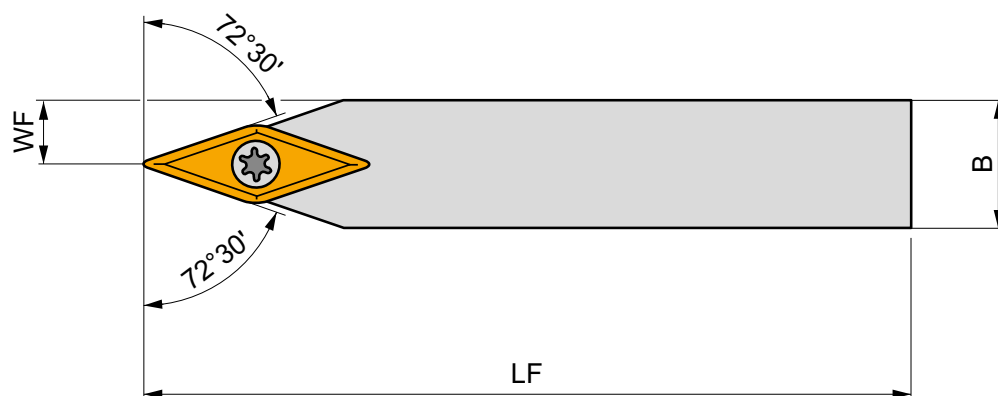
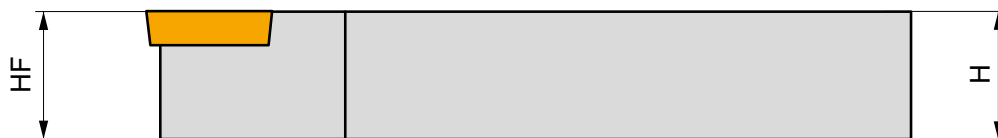
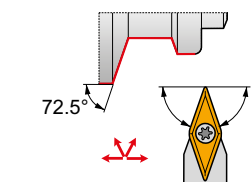

Codice prodotto	H (mm)	B (mm)	HF (mm)	WF (mm)	LF (mm)	LH (mm)	LAMS (°)	GAMO (°)	kg		
N SVVBN 1212 F 11	12	12	12	6	80	-	0	0	0.11	GI194	S01
SVVBN 1616 H 11	16	16	16	8	100	-	0	0	0.18	GI194	S01
SVVBN 2020 K 11	20	20	20	10	125	-	0	0	0.38	GI194	S01
SVVCN 1212 N 13	12	12	12	6	160	-	0	0	0.19	GI211	SV21
SVVCN 1616 H 13	16	16	16	8	100	-	0	0	0.20	GI211	SV21
SVVCN 2020 K 13	20	20	20	10	125	-	0	0	0.36	GI211	SV22
SVVCN 2525 M 13	25	25	25	12.5	150	-	0	0	0.66	GI211	SV22
SVVCN 2020 K 16-M-A	20	20	20	10	125	-	0	0	0.34	GI017	SV10
SVVCN 2525 M 16-M-A	25	25	25	12.5	150	-	0	0	0.68	GI017	SV10
SVVCN 3225 P 16-M-A	32	25	32	12.5	170	-	0	0	0.98	GI017	SV10

GI017	VB.. 1604..	VC.. 1604..
GI194	VB.. 1103..	VC.. 1103..
GI211	-	VC.. 1303..

S01	US 2506-T07P	0.9	M 2.5	6.3	-	-	FLAG T07P	-
SV10	US 3512-T15P	3.0	M 3.5	12.6	SVN 160304	MS 3510	FLAG T15P	HXK 3.5
SV21	5513 020-24	1.5	M 3	8.5	-	-	PT-8002	-
SV22	DVF 0573	1.5	M 3	10.3	DAP 0331	DVT 0332	PT-8002	174.1-870



SVXB(C)(RL) EXT



Utensile esterno, bloccaggio a vite, inserti VB/VC... angolo del tagliente utensile 98/113°

Utensile di tornitura esterna destro/sinistro con bloccaggio a vite, angolo del tagliente utensile 98/113° per inserti positivi VB...11 o 16 e VC... da 11 a 16. Adatto per operazioni di tornitura longitudinale con spallamento, copiatura fino a 30°, conicità e smussi. Disponibile con stelo da 12x12 a 32x25 mm. Corpo trattato per una maggiore durata.

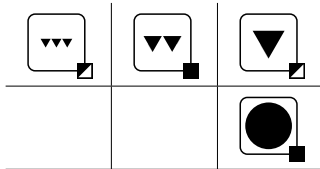
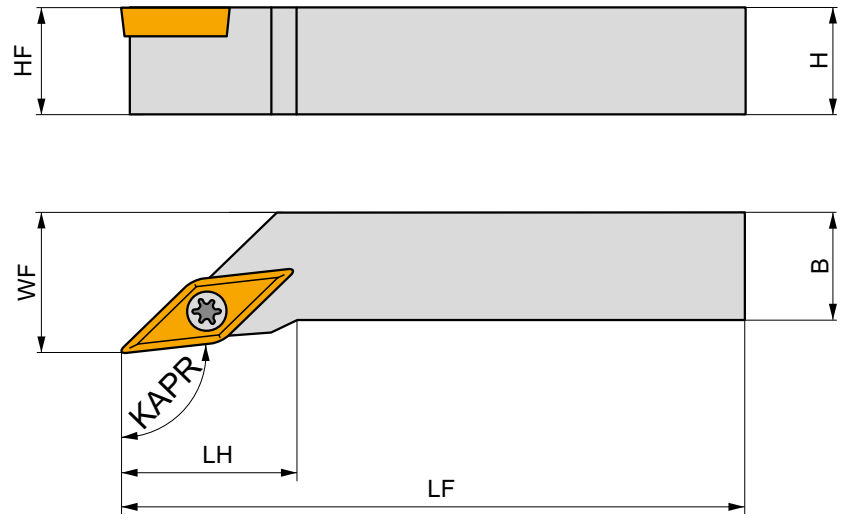
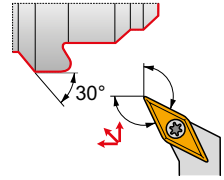

Codice prodotto	H	B	HF	WF	LF	LH	KAPR	LAMS	GAMO	kg	GI	SV
	(mm)	(mm)	(mm)	(mm)	(mm)	(mm)	(°)	(°)	(°)			
R SVXBR 1212 F 11	12	12	12	16	80	20	98	0	0	0.09	GI194	SV01
SVXBR 1616 H 11	16	16	16	20	100	14	98	0	0	0.19	GI194	SV01
SVXCR 2020 K 13	20	20	20	25	125	12	113	0	0	0.38	GI211	SV22
SVXCR 2020 K 16-M-A	20	20	20	25	125	28	98	0	0	0.41	GI017	SV10
SVXCR 2525 M 16-M-A	25	25	25	32	150	32	98	0	0	0.68	GI017	SV10
SVXCR 3225 P 16-M-A	32	25	32	32	170	32	98	0	0	1.00	GI017	SV10
L SVXBL 1212 F 11	12	12	12	16	80	20	98	0	0	0.09	GI194	SV01
SVXBL 1616 H 11	16	16	16	20	100	14	98	0	0	0.19	GI194	SV01
SVXCL 2020 K 13	20	20	20	25	125	12	113	0	0	0.38	GI211	SV22
SVXCL 2020 K 16-M-A	20	20	20	25	125	28	98	0	0	0.38	GI017	SV10
SVXCL 2525 M 16-M-A	25	25	25	32	150	32	98	0	0	0.69	GI017	SV10
SVXCL 3225 P 16-M-A	32	25	32	32	170	32	98	0	0	0.99	GI017	SV10

GI	VB..	VC..
GI017	VB.. 1604..	VC.. 1604..
GI194	VB.. 1103..	VC.. 1103..
GI211	-	VC.. 1303..

SV	US	Nm	M	mm	mm	mm	mm	mm	mm
SV01	US 2506-T07P	0.9	M 2.5	6.3	-	-	FLAG T07P	-	-
SV10	US 3512-T15P	3.0	M 3.5	12.6	SVN 160304	MS 3510	FLAG T15P	HXK 3.5	-
SV22	DVF 0573	1.5	M 3	10.3	DAP 0331	DVT 0332	PT-8002	174.1-870	-

NEW
C.-SVHB(RL) EXT

S

Utensile PSC esterno a cambio rapido, bloccaggio a vite, inserti VB/VC... angolo del tagliente ut. 107.5°

Utensile destro/sinistro per tornitura esterna con bloccaggio a vite e passaggio refrigerante interno, angolo del tagliente utensile 107.5° per inserti positivi VB... 16 o VC... 16. Adatto per la tornitura longitudinale con spallamento, conicità, copiatura fino a 35° e smussi. Disponibile con attacco PSC (Attacco Poligonale) da C4 a C6. Corpo trattato per una maggiore durata.

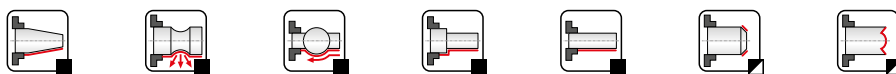
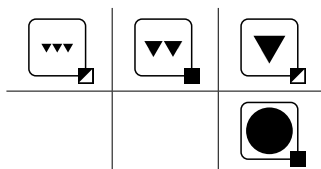
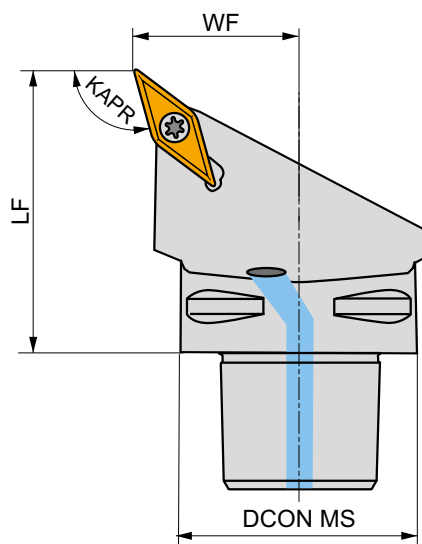
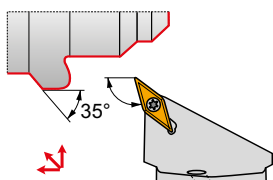

Codice prodotto	DCON MS	WF	LF	KAPR	LAMS	GAMO					
	(mm)	(mm)	(mm)	(°)	(°)	(°)					
R	C4-SVHBR-27050-16	40	27	50	107.5	0	0	✓	0.35	GI017	C-SV16S-1
	C5-SVHBR-35060-16	50	35	60	107.5	0	0	✓	0.64	GI017	C-SV16S-2
	C6-SVHBR-45065-16	63	45	65	107.5	0	0	✓	1.13	GI017	C-SV16S-2
L	C4-SVHBL-27050-16	40	27	50	107.5	0	0	✓	0.35	GI017	C-SV16S-1
	C5-SVHBL-35060-16	50	35	60	107.5	0	0	✓	0.64	GI017	C-SV16S-2
	C6-SVHBL-45065-16	63	45	65	107.5	0	0	✓	1.12	GI017	C-SV16S-2



GI017



VB.. 1604..



VC.. 1604..



C-SV16S-1	US 2001-T15P	3.0	M 3.5	12.1	SVS 270-01	MS 9001	FLAGT15P/3,5	CN 034-01
C-SV16S-2	US 2001-T15P	3.0	M 3.5	12.1	SVS 270-01	MS 9001	FLAGT15P/3,5	CN 034-02



NEW

C.-SVJB(RL) EXT

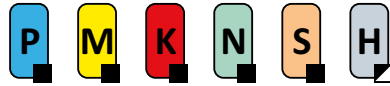

PRAMET

S



Utensile PSC esterno a cambio rapido, bloccaggio a vite, inserti VB/VC... angolo del tagliente ut. 93°

Utensile destro/sinistro per tornitura esterna con bloccaggio a vite e passaggio refrigerante interno, angolo del tagliente utensile 93° per inserti positivi VB...11 o VB...16 e VC...11 e Vc...16. Adatto per la tornitura longitudinale con spallamento, conicità, copiatura fino a 50° e smussi. Disponibile con attacco PSC (Attacco Poligonale) da C3 a C6. Corpo trattato per una maggiore durata.

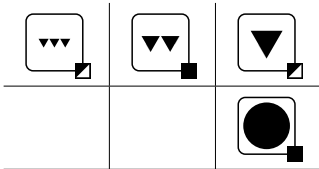
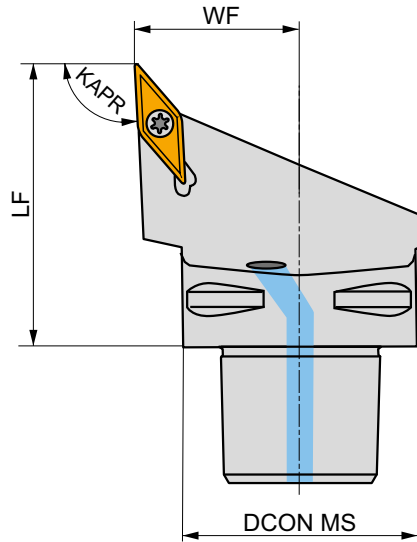
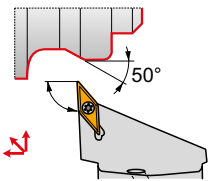

Codice prodotto	DCON MS (mm)	WF (mm)	LF (mm)	KAPR (°)	LAMS (°)	GAMO (°)		kg		
R C3-SVJBR-22040-11-B1	32	22	40	93	0	0	✓	0.17	GI194	C-SV11
C4-SVJBR-27050-11-B1	40	27	50	93	0	0	✓	0.34	GI194	C-SV11
C4-SVJBR-27050-16	40	27	50	93	0	0	✓	0.35	GI017	C-SV16S-1
C5-SVJBR-35060-16	50	35	60	93	0	0	✓	0.63	GI017	C-SV16S-2
C6-SVJBR-45065-16	63	45	65	93	0	0	✓	1.11	GI017	C-SV16S-2
L C4-SVJBL-27050-16	40	27	50	93	0	0	✓	0.35	GI017	C-SV16S-1
C5-SVJBL-35060-16	50	35	60	93	0	0	✓	0.64	GI017	C-SV16S-2
C6-SVJBL-45065-16	63	45	65	93	0	0	✓	1.11	GI017	C-SV16S-2

GI017	VB.. 1604..	VC.. 1604..
GI194	VB.. 1103..	VC.. 1103..

C-SV11	US 2003-T07P	0.8	M 2.5	6.5	-	-	FLAG T07P	CN 034-01
C-SV16S-1	US 2001-T15P	3.0	M 3.5	12.1	SVS 270-01	MS 9001	FLAG T15P/3,5	CN 034-01
C-SV16S-2	US 2001-T15P	3.0	M 3.5	12.1	SVS 270-01	MS 9001	FLAG T15P/3,5	CN 034-02

NEW
C-SVVBN EXT

PRAMET
S

Utensile esterno PSC a cambio rapido, bloccaggio a vite, angolo del tagliente 72,5°, inserti VB/VC..

Utensile esterno di tornitura neutro con fori per refrigerante interno, bloccaggio a vite per inserti VB .. 16 e VC .. 16 positivi. Adatto per tornitura longitudinale esterna senza spallamento, conica, copiatura fino a 72,5 ° e smussi. Attacco a cambio rapido PSC (Polygon Shank Coupling) dimensioni da C4 a C6. Corpo trattato per una maggiore durata dell'utensile.

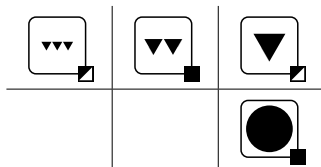
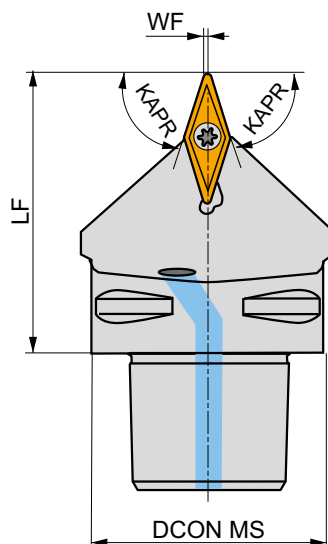
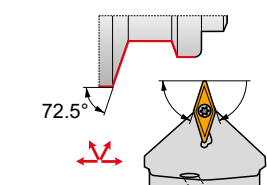

Codice prodotto	DCON MS	WF	LF	KAPR	LAMS	GAMO				
	(mm)	(mm)	(mm)	(°)	(°)	(°)				
N C4-SVVBN-00050-16	40	0.6	50	72.5	0	0	✓	0.32	GI017	C-SV16S-1
C5-SVVBN-00060-16	50	0.6	60	72.5	0	0	✓	0.56	GI017	C-SV16S-2
C6-SVVBN-00065-16	63	0.6	65	72.5	0	0	✓	0.99	GI017	C-SV16S-2

GI017	VB.. 1604..	VC.. 1604..

C-SV16S-1	US 2001-T15P	3.0	M 3.5	12.1	SVS 270-01	MS 9001	FLAG T15P/3,5	CN 034-01
C-SV16S-2	US 2001-T15P	3.0	M 3.5	12.1	SVS 270-01	MS 9001	FLAG T15P/3,5	CN 034-02



SVJB(RL) INT

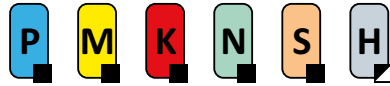

PRAMET

S



Utensile interno, bloccaggio a vite, inserti VB/VC... angolo del tagliente utensile 93°

Bareno destro/sinistro per tornitura interna con bloccaggio a vite e passaggio refrigerante interno, angolo del tagliente utensile 93° per inserti positivi VB...11 o VC...11. Diametro interno minimo tornibile Ø25 mm. Adatto per la copiatura frontale al di sotto di 50°. Disponibile con stelo Ø20 mm e Ø25 mm. Corpo trattato per una maggiore durata.

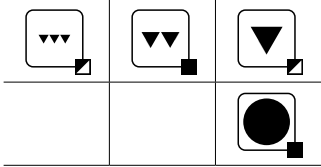
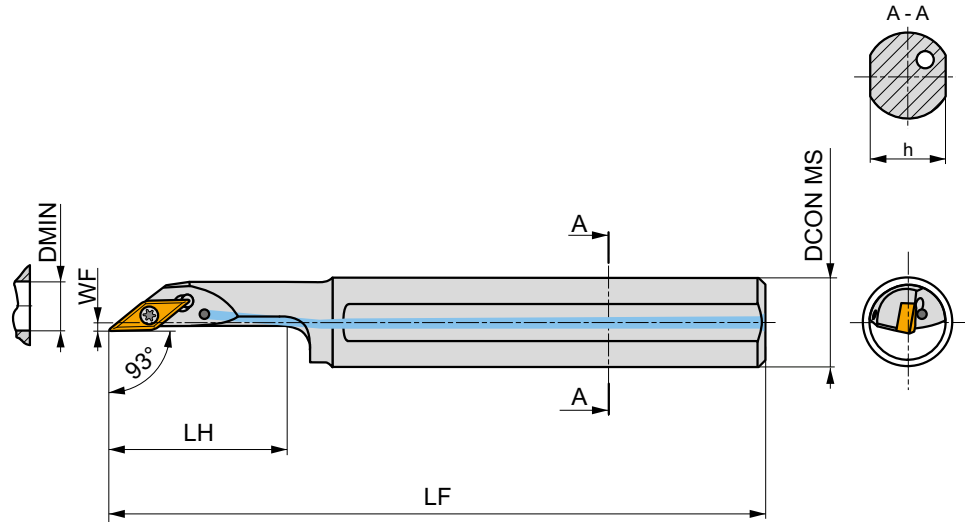
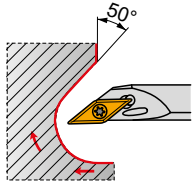

Codice prodotto	DCON MS (mm)	DMIN (mm)	WF (mm)	H (mm)	LF (mm)	LH (mm)	LAMS (°)	GAMO (°)		kg		
R A20R-SVJBR 11	20	25	2	18	200	40	-5	-5	✓	0.44	GI194	S07
A25S-SVJBR 11	25	32	3.5	23	250	50	-5	-5	✓	0.82	GI194	S07
L A20R-SVJBL 11	20	25	2	18	200	40	-5	-5	✓	0.42	GI194	S07
A25S-SVJBL 11	25	32	3.5	23	250	50	-5	-5	✓	0.82	GI194	S07

GI194	VB.. 1103..	VC.. 1103..

S07	US 2506-T07P	0.9	M 2.5	6.3	FLAG T07P



SVLC(RL) INT



Utensile interno, bloccaggio a vite, inserti VC... angolo del tagliente utensile 50°

Bareno destro/sinistro per tornitura interna con bloccaggio a vite e passaggio refrigerante interno, angolo del tagliente utensile 50° per inserto positivo VC...13. Diametro interno minimo tornibile Ø27 mm. Adatto per un'ampia gamma di operazioni di tornitura in tirata e copiatura sotto i 48°. Disponibile con stelo da Ø20 mm a Ø32 mm. Corpo trattato per una maggiore durata.

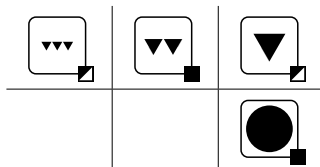
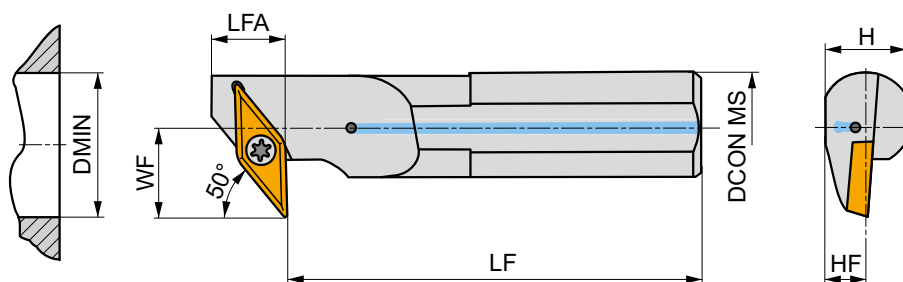
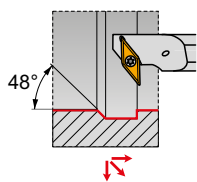

Codice prodotto	DCON MS	DMIN	WF	H	LF	HF	LFA	LAMS	GAMO					
	(mm)	(mm)	(mm)	(mm)	(mm)	(mm)	(mm)	(°)	(°)					
R	A20S-SVLCR 13-X	20	27	15	18	250	9	15	-4	-2	✓	0.57	GI211	SV21
	A25T-SVLCR 13-X	25	35	20	24	300	12	18	-2	-2	✓	1.01	GI211	SV22
	A32T-SVLCR 13-X	32	43	25	30	300	15	18	-1	-2	✓	1.75	GI211	SV22
L	A20S-SVLCCL 13-X	20	27	15	18	250	9	15	-4	-2	✓	0.57	GI211	SV21
	A25T-SVLCCL 13-X	25	35	20	24	300	12	18	-2	-2	✓	0.05	GI211	SV22
	A32T-SVLCCL 13-X	32	43	25	30	300	15	18	-1	-2	✓	1.75	GI211	SV22



GI211



VC.. 1303..



SV21



5513 020-24



1.5



M3



8.5



-



-



PT-8002



-

SV22

DVF 0573

1.5

M3

10.3

DAP 0331

DVT 0332

PT-8002

174.1-870



SVQB(C)(RL) INT



PRAMET

S



Utensile interno, bloccaggio a vite, inserti VB/VC... angolo del tagliente utensile 107.5°

Bareno destro/sinistro per tornitura interna con bloccaggio a vite e passaggio refrigerante interno, angolo del tagliente utensile 107.5° per inserti positivi VB.../VC...da 11 a 16. Diametro interno minimo tornibile Ø20 mm. Adatto per un'ampia gamma di applicazioni di tornitura interna. Disponibile con stelo da Ø16 mm a Ø40 mm. Corpo trattato per una maggiore durata.

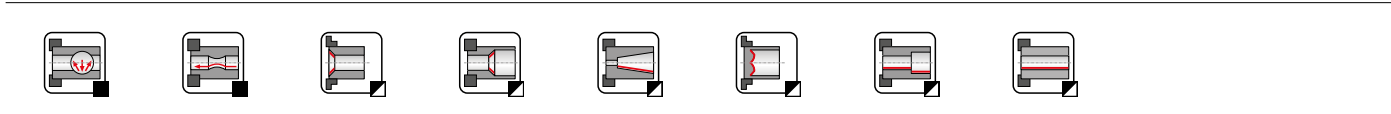
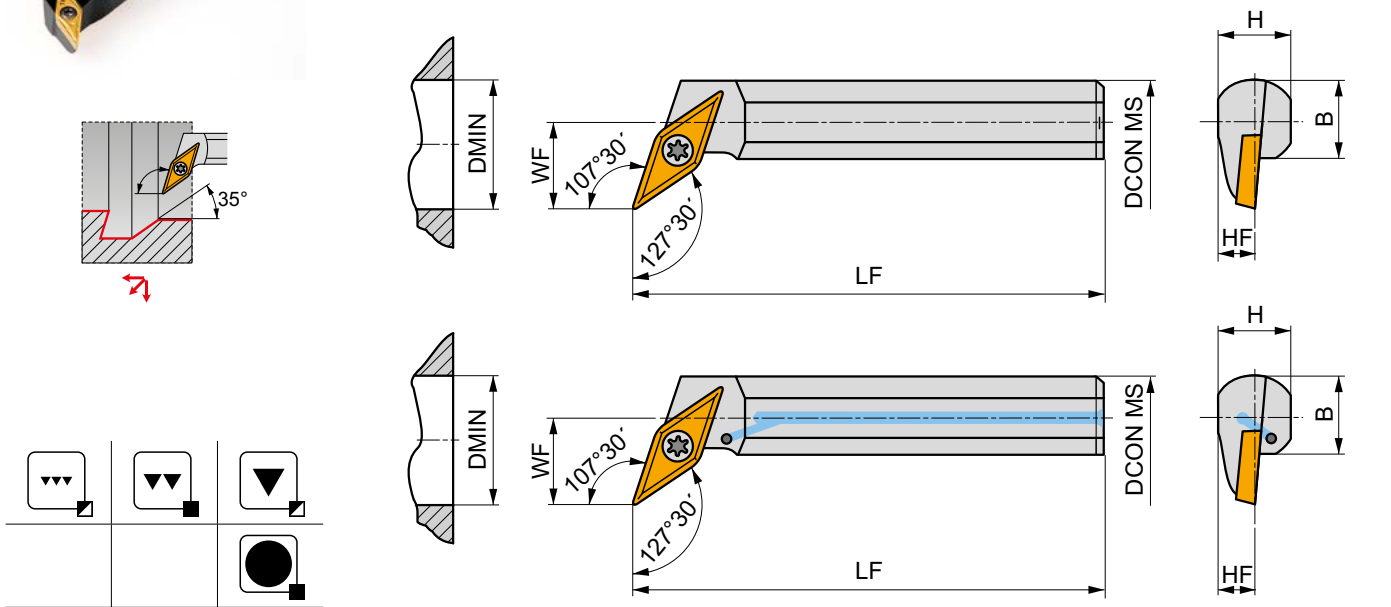

Codice prodotto	DCON MS	DMIN	WF	H	B	LF	LAMS	GAMO	✓	kg	GI194	SV21	
	(mm)	(mm)	(mm)	(mm)	(mm)	(mm)	(°)	(°)					
R	A16R-SVQBR 11	16	20	11	14.5	15	200	-5	0	✓	0.33	GI194	SO1
	A20S-SVQBR 11	20	25	13	18	18.5	250	-4	0	✓	0.58	GI194	SO1
	A16R-SVQCR 13	16	21	11	15	15	200	-6	0	✓	0.30	GI211	SV21
	A20S-SVQCR 13	20	25	13	18	18.5	250	-4	0	✓	0.12	GI211	SV21
	S25T-SVQCR 16	25	32	17	23	23	300	-7	0	-	1.10	GI017	SO8
	S32U-SVQCR 16	32	40	22	30	30	350	-5	0	-	2.07	GI017	SO8
	S40V-SVQCR 16-A	40	50	27	38	38	400	-5	0	-	3.80	GI017	SV10
L	A16R-SVQBL 11	16	20	11	14.5	15	200	-5	0	✓	0.33	GI194	SO1
	A20S-SVQBL 11	20	25	13	18	18.5	250	-4	0	✓	0.58	GI194	SO1
	A16R-SVQCL 13	16	21	11	15	15	200	-6	0	✓	0.29	GI211	SV21
	A20S-SVQCL 13	20	25	13	18	18.5	250	-4	0	✓	0.54	GI211	SV21
	S25T-SVQCL 16	25	32	17	23	23	300	-7	0	-	1.09	GI017	SO8
	S32U-SVQCL 16	32	40	22	30	30	350	-5	0	-	2.07	GI017	SO8
	S40V-SVQCL 16-A	40	50	27	38	38	400	-5	0	-	4.10	GI017	SV10

GI017	VB.. 1604..	VC.. 1604..
GI194	VB.. 1103..	VC.. 1103..
GI211	-	VC.. 1303..

SO1	US 2506-T07P	0.9	M 2.5	6.3	-	-	FLAG T07P	-
SO8	US 3510-T15P	3.0	M 3.5	10.6	-	-	FLAG T15P	-
SV10	US 3512-T15P	3.0	M 3.5	12.6	SVN 160304	MS 3510	FLAG T15P	HXK 3.5
SV21	5513 020-24	1.5	M 3	8.5	-	-	PT-8002	-



SVUB(C)(RL) INT



PRAMET

S



Utensile interno, bloccaggio a vite, inserti VB/VC... angolo del tagliente utensile 93°

Bareno destro/sinistro per tornitura interna con bloccaggio a vite e passaggio refrigerante interno, angolo del tagliente utensile 93° per inserti positivi VB.../VC...da 11 a 16. Diametro interno minimo tornibile Ø20 mm. Adatto per un'ampia gamma di applicazioni di tornitura e copiatura interna al di sotto di 50°. Disponibile con stelo da Ø16 mm a Ø40 mm. Corpo trattato per una maggiore durata.

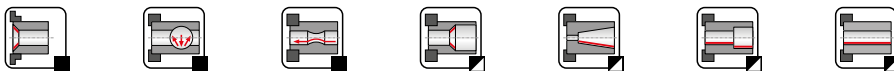
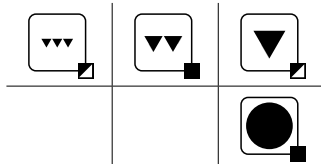
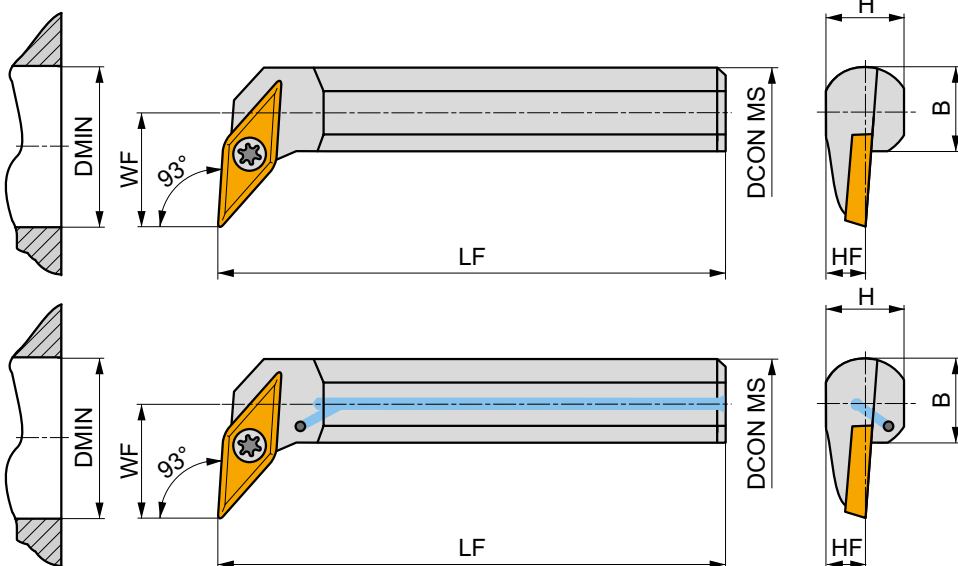
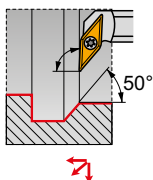

Codice prodotto	DCON MS (mm)	DMIN (mm)	WF (mm)	H (mm)	B (mm)	LF (mm)	LAMS (°)	GAMO (°)				
R A16R-SVUBR 11	16	20	11	14.5	15	200	-5	0	✓	0.34	GI194	S01
A20S-SVUBR 11	20	25	13	18	18.8	250	-4	0	✓	0.58	GI194	S01
A20S-SVUCR 13	20	25	13	19	18.5	250	-4	2	✓	0.40	GI211	SV21
A25T-SVUCR 13	25	32	17	24	23	300	-2	2	✓	0.96	GI211	SV22
A32T-SVUCR 13	32	40	22	30	30	300	-1	2	✓	1.70	GI211	SV22
S25T-SVUCR 16	25	32	17	23	23	300	-7	0	-	1.10	GI017	S08
S32U-SVUCR 16	32	40	22	30	30	350	-5	0	-	2.10	GI017	S08
S40V-SVUCR 16-A	40	50	27	38	38	400	-5	0	-	4.10	GI017	SV10
L A16R-SVUBL 11	16	20	11	14.5	15	200	-5	0	✓	0.34	GI194	S01
A20S-SVUBL 11	20	25	13	18	18.5	250	-4	0	✓	0.58	GI194	S01
A20S-SVUCL 13	20	25	13	19	18.5	250	-4	2	✓	0.32	GI211	SV21
A25T-SVUCL 13	25	32	17	24	23	300	-2	2	✓	0.96	GI211	SV22
A32T-SVUCL 13	32	40	22	30	30	300	-1	2	✓	1.70	GI211	SV22
S25T-SVUCL 16	25	32	17	23	23	300	-7	0	-	1.10	GI017	S08
S32U-SVUCL 16	32	40	22	30	30	350	-5	0	-	2.10	GI017	S08
S40V-SVUCL 16-A	40	50	27	38	38	400	-5	0	-	4.10	GI017	SV10

GI017	VB.. 1604..
GI194	VB.. 1103..
GI211	-
	VC.. 1604..
	VC.. 1103..
	VC.. 1303..

S01	US 2506-T07P	0.9	M 2.5	6.3	-	-	FLAG T07P	-
S08	US 3510-T15P	3.0	M 3.5	10.6	-	-	FLAG T15P	-
SV10	US 3512-T15P	3.0	M 3.5	12.6	SVN 160304	MS 3510	FLAG T15P	HXX 3.5
SV21	5513 020-24	1.5	M 3	8.5	-	-	PT-8002	-
SV22	DVF 0573	1.5	M 3	10.3	DAP 0331	DVT 0332	PT-8002	174.1-870



SVXC(RL) INT



PRAMET

S



Utensile interno, bloccaggio a vite, inserti VC... angolo del tagliente utensile 113°

Bareno destro/sinistro per tornitura interna con bloccaggio a vite e passaggio refrigerante interno, angolo del tagliente utensile 113° per inserto positivo VC...07. Diametro interno minimo tornibile Ø12.5 mm. Adatto per un'ampia gamma di operazioni di tornitura interna e copiatura sotto i 32°. Disponibile con stelo da Ø10 mm a Ø16 mm. Corpo trattato per una maggiore durata.

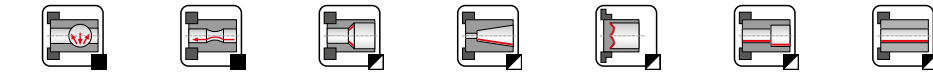
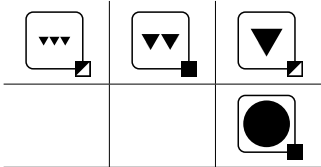
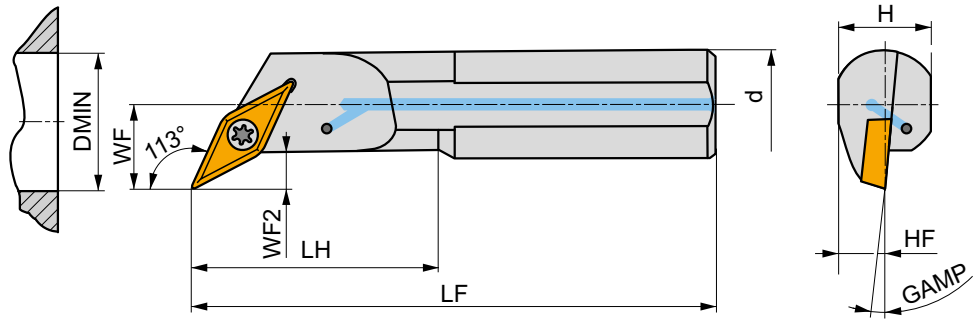
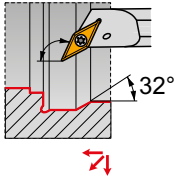

Codice prodotto	D CON MS	D MIN	WF	H	LF	HF	LH	WF2	GAMP	✓	kg	GI234	SV23
	(mm)	(mm)	(mm)	(mm)	(mm)	(mm)	(mm)	(mm)	(°)				
R	A10H-SVXCR 07	10	12.5	7	9	100	4.5	22	3	-10	✓	0.06	GI234 SV23
	A12K-SVXCR 07	12	15.5	9	11	125	5.5	28	3	-8	✓	0.11	GI234 SV23
	A16M-SVXCR 07	16	17.5	11	15	150	7.5	36	3	-6	✓	0.19	GI234 SV23
L	A10H-SVXCL 07	10	12.5	7	9	100	4.5	22	3	-10	✓	0.06	GI234 SV23
	A12K-SVXCL 07	12	15.5	9	11	125	5.5	28	3	-8	✓	0.11	GI234 SV23
	A16M-SVXCL 07	16	17.5	11	15	150	7.5	36	3	-6	✓	0.20	GI234 SV23

GI234 VC.. 0702..

SV23 DVF 3584 0.6 Nm M 2 5.5 DMD 1650



SVXC(RL)-E INT



Utensile interno in metallo duro, bloccaggio a vite, per inserto VC... angolo del tagliente utensile 113°

Bareno destro/sinistro in metallo duro per tornitura interna con bloccaggio a vite e passaggio refrigerante interno, angolo del tagliente utensile 113° per inserto positivo VC...07. Diametro interno minimo tornibile $\varnothing 12.5$ mm. Adatto per un'ampia gamma di operazioni di tornitura e copiatura fino a 32°. Disponibile con stelo da $\varnothing 10$ mm a $\varnothing 16$ mm. Per sporgenze utensile $> 3xD$.

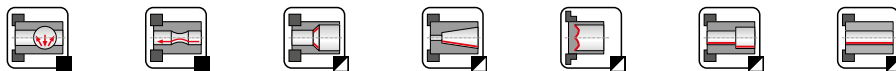
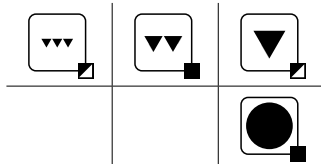
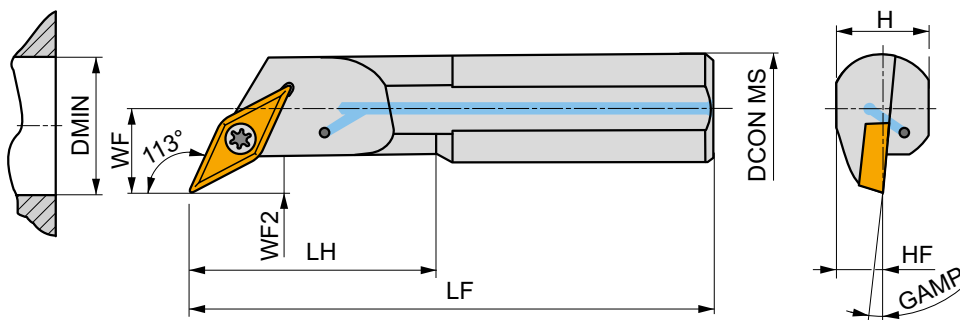
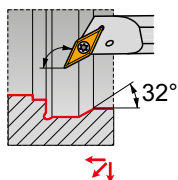

Codice prodotto	DCON MS	DMIN	WF	H	HF	LF	LH	WF2	GAMP				
	(mm)	(mm)	(mm)	(mm)	(mm)	(mm)	(mm)	(mm)	(°)				
R	E10H-SVXCR 07	10	12.5	7	9	4.5	100	22	3	-10	✓	0.10	G1234 SV23
	E12K-SVXCR 07	12	15.5	9	11	5.5	125	28	3	-8	✓	0.19	G1234 SV23
	E16M-SVXCR 07	16	17.5	11	15	7.5	150	36	3	-6	✓	0.33	G1234 SV23
L	E10H-SVXCL 07	10	12.5	7	9	4.5	100	22	3	-10	✓	0.10	G1234 SV23
	E12K-SVXCL 07	12	15.5	9	11	5.5	125	28	3	-8	✓	0.19	G1234 SV23
	E16M-SVXCL 07	16	17.5	11	15	7.5	150	36	3	-6	✓	0.33	G1234 SV23



G1234



VC..0702..



SV23



DVF 3584



0.6



M 2



5.5



DMD 1650



NEW

C.-SVQB(RL) INT



PRAMET

S



Utensile PSC interno a cambio rapido, bloccaggio a vite, inserti VB/VC... angolo del tagliente ut. 107.5°

Utensile destro/sinistro per tornitura interna con bloccaggio a vite e passaggio refrigerante interno, angolo del tagliente utensile 107.5° per inserti positivi VB... 16 o VC... 16. Diametro interno minimo tornibile Ø33 mm. Adatto per un'ampia gamma di applicazioni di tornitura interna. Attacco PSC (Attacco Poligonale) da C4 a C5 con lunghezze diverse. Corpo trattato per una maggiore durata.

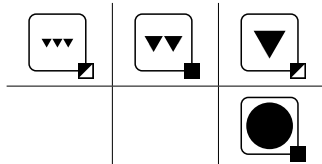
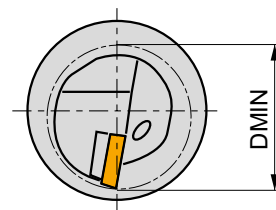
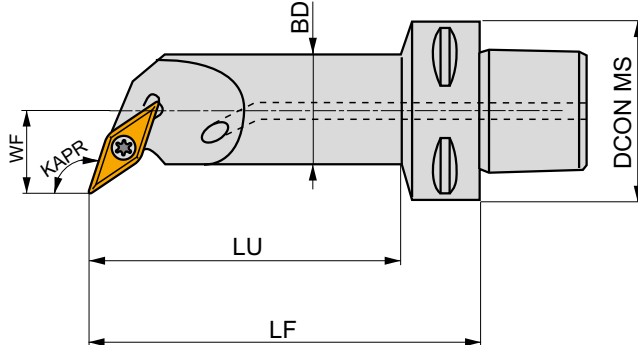
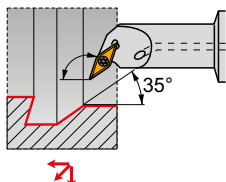

Codice prodotto	DCON MS (mm)	DMIN (mm)	WF (mm)	LF (mm)	LU (mm)	BD (mm)	KAPR (°)	LAMS (°)	GAMO (°)				
R C4-SVQBR-18090-16	40	33	18	90	68	25	107.5	-7.2	0	✓	0.48	GI017	SV16
C5-SVQBR-18090-16	50	33	18	90	67	25	107.5	-7.2	0	✓	0.67	GI017	SV16
L C4-SVQBL-18090-16	40	33	18	90	68	25	107.5	-7.2	0	✓	0.48	GI017	SV16
C5-SVQBL-18090-16	50	33	18	90	67	25	107.5	-7.2	0	✓	0.68	GI017	SV16

GI017	VB.. 1604..	VC.. 1604..

SV16	US 2010-T15P	3.0	M 3.5	10.1	FLAG T15P/3,5



WC

02/ 06/ 08/ 16

INSERTI IN METALLO DURO

WCGT



212

WCGX



213

WCMT



213

ABBINAMENTO DELLA DIMENSIONE CORRETTA (esempio)

Inserto

WCGT 020102E-FF2

Portainsero

A0508H-SWUCR 02

TORNITURA ISO - ESTERNA

SWLC(RL) EXT

95°

WC..

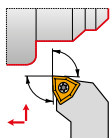
06
0816×16
25×25

215

212 – 214

TORNITURA ISO INTERNA

SWLC(RL) INT

95°

WC..

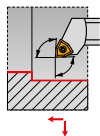
06
0825
40

216

212 – 214

SWUC(RL) INT

93°

WC..

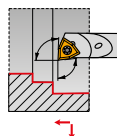

02

5,8
7,8

217

212 – 214

SWUC(RL)-E INT

93°

WC..

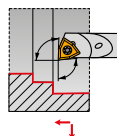

02

5,8
7,8

218

212 – 214



WCGT



	IC	D1	L	S
	(mm)	(mm)	(mm)	(mm)
0201	3.970	2.20	2.70	1.59
06T3	9.525	4.40	6.50	3.97
0804	12.700	5.50	8.70	4.76

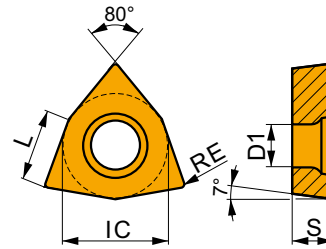

Idoneità e valori iniziali per velocità di taglio (Vc), avanzamento (f) e profondità di taglio (ap). Fare riferimento alla nostra App Machining Calculator per ulteriori calcoli.

Codice prodotto	RE	P			M			K			N			S			H		
		vc	f	ap	vc	f	ap	vc	f	ap	vc	f	ap	vc	f	ap	vc	f	ap
	(mm)	(m/min)	(mm/rev)	(mm)	(m/min)	(mm/rev)	(mm)	(m/min)	(mm/rev)	(mm)	(m/min)	(mm/rev)	(mm)	(m/min)	(mm/rev)	(mm)	(m/min)	(mm/rev)	(mm)

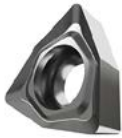

AL geometria con design altamente positivo per operazioni da finitura fino a sgrossatura, da taglio continuo a leggermente interrotto.

WCGT 06T302F-AL	HF7	0.2	—	—	—	—	—	—	—	—	—	—	—	—	—	—	—	—	—	—
WCGT 06T304F-AL	HF7	0.4	—	—	—	—	—	—	—	—	—	—	—	—	—	—	—	—	—	—
	T0315	0.4	—	—	—	—	—	—	—	—	—	—	—	—	—	—	—	—	—	—
WCGT 06T308F-AL	HF7	0.8	—	—	—	—	—	—	—	—	—	—	—	—	—	—	—	—	—	—
WCGT 080412F-AL	HF7	1.2	—	—	—	—	—	—	—	—	—	—	—	—	—	—	—	—	—	—
	T0315	1.2	—	—	—	—	—	—	—	—	—	—	—	—	—	—	—	—	—	—

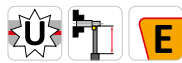
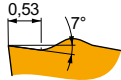

FF2 geometria positiva per operazioni da super finitura fino a finitura, da taglio continuo a leggermente interrotto.

WCGT 020102E-FF2	HF7	0.2	—	—	—	—	—	—	—	—	—	—	—	—	—	—	—	—	—	—
	T8330	0.2	■	205	0.05	0.8	—	—	—	■	190	0.05	0.8	—	—	—	—	—	—	—
	T8430	0.2	■	280	0.05	0.8	—	—	—	▣	230	0.05	0.8	—	—	—	—	—	—	—
	TT010	0.2	■	345	0.05	0.5	—	—	—	—	—	—	—	—	—	—	—	—	—	—
WCGT 020104E-FF2	HF7	0.4	—	—	—	—	—	—	—	—	—	—	—	—	—	—	—	—	—	—
	T8330	0.4	■	170	0.12	0.8	—	—	—	■	155	0.12	0.8	—	—	—	—	—	—	—
	T8430	0.4	■	205	0.12	0.8	—	—	—	▣	170	0.12	0.8	—	—	—	—	—	—	—
	TT010	0.4	■	350	0.06	0.5	—	—	—	—	—	—	—	—	—	—	—	—	—	—



WCGX

	IC	D1	L	S
	(mm)	(mm)	(mm)	(mm)
0201	3.970	2.20	2.70	1.59

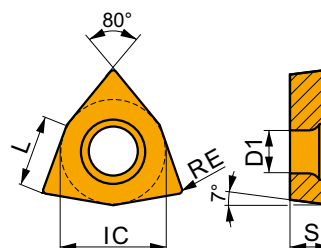

Idoneità e valori iniziali per velocità di taglio (Vc), avanzamento (f) e profondità di taglio (ap). Fare riferimento alla nostra App Machining Calculator per ulteriori calcoli.

Codice prodotto	RE	P			M			K			N			S			H			
		vc	f	ap	vc	f	ap	vc	f	ap	vc	f	ap	vc	f	ap	vc	f	ap	
	(mm)	(m/min)	(mm/rev)	(mm)	(m/min)	(mm/rev)	(mm)	(m/min)	(mm/rev)	(mm)	(m/min)	(mm/rev)	(mm)	(m/min)	(mm/rev)	(mm)	(m/min)	(mm/rev)	(mm)	

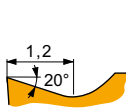

JZ geometria sinistra per operazioni di super finitura, taglio continuo.

WCGX 020102FL-JZ	TT010	0.2	■	330	0.06	0.5	■	195	0.05	0.5	■	-	-	-	■	-	-	-	■	-	-	-
-------------------------	--------------	-----	---	-----	------	-----	---	-----	------	-----	---	---	---	---	---	---	---	---	---	---	---	---

WCMT

	IC	D1	L	S
	(mm)	(mm)	(mm)	(mm)
06T3	9.525	4.40	6.50	3.97
0804	12.700	5.50	8.70	4.76

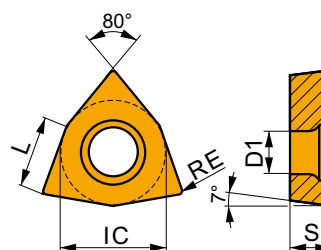

Idoneità e valori iniziali per velocità di taglio (Vc), avanzamento (f) e profondità di taglio (ap). Fare riferimento alla nostra App Machining Calculator per ulteriori calcoli.

Codice prodotto	RE	P			M			K			N			S			H			
		vc	f	ap	vc	f	ap	vc	f	ap	vc	f	ap	vc	f	ap	vc	f	ap	
	(mm)	(m/min)	(mm/rev)	(mm)	(m/min)	(mm/rev)	(mm)	(m/min)	(mm/rev)	(mm)	(m/min)	(mm/rev)	(mm)	(m/min)	(mm/rev)	(mm)	(m/min)	(mm/rev)	(mm)	

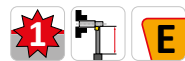
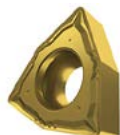

FM geometria per operazioni da finitura fino a semi sgrassatura, da taglio continuo a leggermente interrotto.

WCMT 06T304E-FM	T7325	0.4	■	195	0.15	1.2	■	150	0.15	1.2	■	-	-	-	■	-	-	-	■	-	-	-
	T7335	0.4	■	190	0.15	1.2	■	145	0.15	1.2	■	-	-	-	■	-	-	-	■	-	-	-
	T8315	0.4	■	180	0.15	1.2	■	105	0.14	1.2	■	170	0.15	1.2	■	540	0.18	1.2	■	-	-	-
	T8330	0.4	■	170	0.15	1.2	■	100	0.14	1.2	■	160	0.15	1.2	■	510	0.18	1.2	■	-	-	-
	T8430	0.4	■	200	0.15	1.2	■	110	0.14	1.2	■	165	0.15	1.2	■	555	0.18	1.2	■	-	-	-
	T9315	0.4	■	275	0.15	1.2	■	-	-	-	■	260	0.15	1.2	■	-	-	-	■	-	-	-
WCMT 06T308E-FM	T9325	0.4	■	245	0.15	1.2	■	145	0.15	1.2	■	230	0.15	1.2	■	-	-	-	■	-	-	-
	T7325	0.8	■	215	0.20	1.2	■	165	0.18	1.2	■	-	-	-	■	-	-	-	■	-	-	-
	T7335	0.8	■	205	0.20	1.2	■	155	0.18	1.2	■	-	-	-	■	-	-	-	■	-	-	-
	T8315	0.8	■	195	0.20	1.2	■	115	0.18	1.2	■	185	0.20	1.2	■	585	0.24	1.2	■	-	-	-
	T8330	0.8	■	185	0.20	1.2	■	110	0.18	1.2	■	175	0.20	1.2	■	555	0.24	1.2	■	-	-	-
	T8430	0.8	■	210	0.20	1.2	■	115	0.18	1.2	■	175	0.20	1.2	■	585	0.24	1.2	■	-	-	-
	T9315	0.8	■	290	0.20	1.2	■	-	-	-	■	275	0.20	1.2	■	-	-	-	■	-	-	-
T9325	0.8	■	260	0.20	1.2	■	155	0.18	1.2	■	245	0.20	1.2	■	-	-	-	■	-	-	-	



Idoneità e valori iniziali per velocità di taglio (Vc), avanzamento (f) e profondità di taglio (ap). Fare riferimento alla nostra App Machining Calculator per ulteriori calcoli.

Codice prodotto	RE (mm)	P			M			K			N			S			H		
		vc (m/min)	f (mm/rev)	ap (mm)	vc (m/min)	f (mm/rev)	ap (mm)	vc (m/min)	f (mm/rev)	ap (mm)	vc (m/min)	f (mm/rev)	ap (mm)	vc (m/min)	f (mm/rev)	ap (mm)	vc (m/min)	f (mm/rev)	ap (mm)

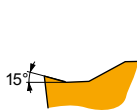
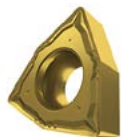

FM geometria per operazioni da finitura fino a semi sgrossatura, da taglio continuo a leggermente interrotto.

WCMT 080404E-FM	T7325	0.4	190	0.15	1.7	145	0.15	1.7	-	-	-	-	-	-	-	-	-	-
	T8315	0.4	170	0.15	1.7	100	0.14	1.7	160	0.15	1.7	510	0.18	1.7	-	-	-	-
	T8330	0.4	165	0.15	1.7	95	0.14	1.7	155	0.15	1.7	495	0.18	1.7	-	-	-	-
	T8430	0.4	195	0.15	1.7	105	0.14	1.7	160	0.15	1.7	540	0.18	1.7	-	-	-	-
	T9315	0.4	265	0.15	1.7	-	-	-	250	0.15	1.7	-	-	-	-	-	-	-
	T9325	0.4	240	0.15	1.7	140	0.15	1.7	225	0.15	1.7	-	-	-	-	-	-	-
WCMT 080408E-FM	T7325	0.8	205	0.20	1.7	155	0.18	1.7	-	-	-	-	-	-	-	-	-	-
	T7335	0.8	200	0.20	1.7	155	0.18	1.7	-	-	-	-	-	-	-	-	-	-
	T8315	0.8	190	0.20	1.7	110	0.18	1.7	180	0.20	1.7	570	0.24	1.7	-	-	-	-
	T8330	0.8	180	0.20	1.7	105	0.18	1.7	170	0.20	1.7	540	0.24	1.7	-	-	-	-
	T8430	0.8	205	0.20	1.7	110	0.18	1.7	170	0.20	1.7	570	0.24	1.7	-	-	-	-
	T9315	0.8	280	0.20	1.7	-	-	-	265	0.20	1.7	-	-	-	-	-	-	-
WCMT 080412E-FM	T9325	0.8	250	0.20	1.7	150	0.18	1.7	235	0.20	1.7	-	-	-	-	-	-	-
	T8330	1.2	175	0.27	1.7	105	0.24	1.7	165	0.27	1.7	525	0.32	1.7	-	-	-	-
	T8430	1.2	190	0.27	1.7	105	0.24	1.7	155	0.27	1.7	525	0.32	1.7	-	-	-	-
	T9325	1.2	235	0.27	1.7	140	0.24	1.7	220	0.27	1.7	-	-	-	-	-	-	-

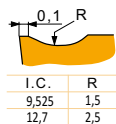

RF geometria per operazioni da semi sgrossatura fino a sgrossatura, da taglio continuo a interrotto.

WCMT 06T308E-RF	T7335	0.8	165	0.20	1.5	125	0.18	1.5	-	-	-	-	-	-	-	-	-
WCMT 080412E-RF	T7335	1.2	160	0.22	2.2	120	0.22	2.2	-	-	-	-	-	-	-	-	-

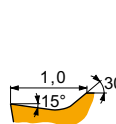

UR geometria per lavorazioni leggere e finitura, da taglio continuo a leggermente interrotto.

WCMT 06T308E-UR	T7325	0.8	185	0.20	1.2	140	0.18	1.2	-	-	-	-	-	-	-	-	-
	T9315	0.8	250	0.20	1.2	-	-	-	235	0.20	1.2	-	-	-	-	-	-
	T9325	0.8	225	0.20	1.2	135	0.18	1.2	210	0.20	1.2	-	-	-	-	-	-

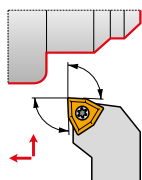

SWLC(RL) EXT

Utensile esterno, bloccaggio a vite, inserti WC... angolo del tagliente utensile 95°

Utensile di tornitura esterna destro/sinistro con bloccaggio a vite, angolo del tagliente utensile 95° per inserti positivi WC...06 e 08. Adatto per operazioni di sfacciatura e tornitura longitudinale con spallamento, conicità e smussi. Disponibile con stelo da 16x16 a 25x25 mm. Corpo trattato per una maggiore durata.

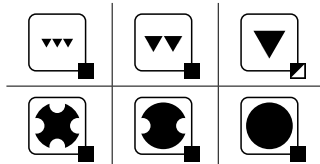
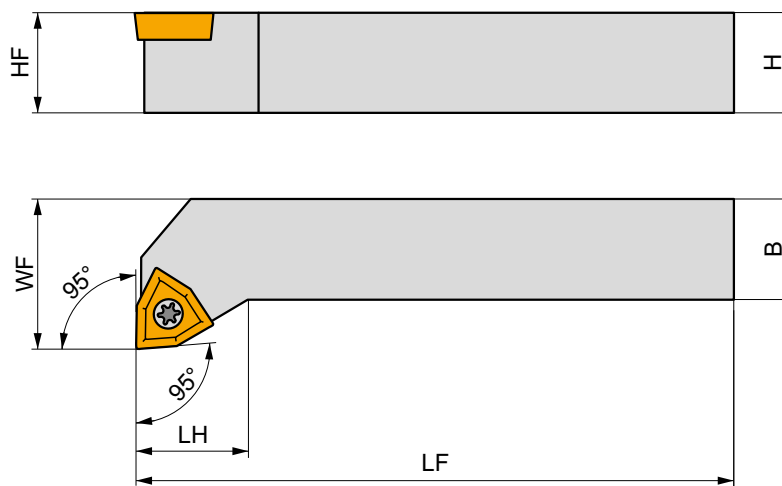

Codice prodotto	H	B	HF	WF	LF	LH	LAMS	GAMO	kg	GI055	S04	
	(mm)	(mm)	(mm)	(mm)	(mm)	(mm)	(°)	(°)				
R	SWLCR 1616 H 06	16	16	16	20	100	15	0	0	0.24	GI055	S04
	SWLCR 2020 K 06	20	20	20	25	125	15	0	0	0.40	GI055	S04
	SWLCR 2525 M 08	25	25	25	32	150	20	0	0	0.77	GI049	S09
L	SWLCL 1616 H 06	16	16	16	20	100	15	0	0	0.23	GI055	S04
	SWLCL 2020 K 06	20	20	20	25	125	15	0	0	0.40	GI055	S04
	SWLCL 2525 M 08	25	25	25	32	150	20	0	0	0.75	GI049	S09



GI049

WC.. 0804..

GI055

WC.. 06T3..



S04

US 3510-T15P

3.0

M 3.5

10.6

FLAGT15P

S09

US 4512-T15P

5.0

M 4.5

12.2

FLAGT15P



SWLC(RL) INT

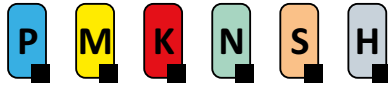

PRAMET

S



Utensile interno, bloccaggio a vite, inserti WC... angolo del tagliente utensile 95°

Bareno destro/sinistro per tornitura interna con bloccaggio a vite e passaggio refrigerante interno, angolo del tagliente utensile 95° per inserti positivi WC...06 e 08. Diametro interno minimo tornibile Ø25 mm. Adatto per operazioni di tornitura longitudinale, spallamento, conicità e smussi. Disponibile con stelo da Ø20 mm a Ø32 mm. Corpo trattato per una maggiore durata.

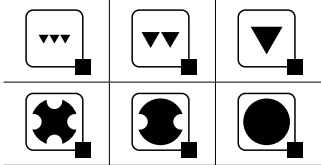
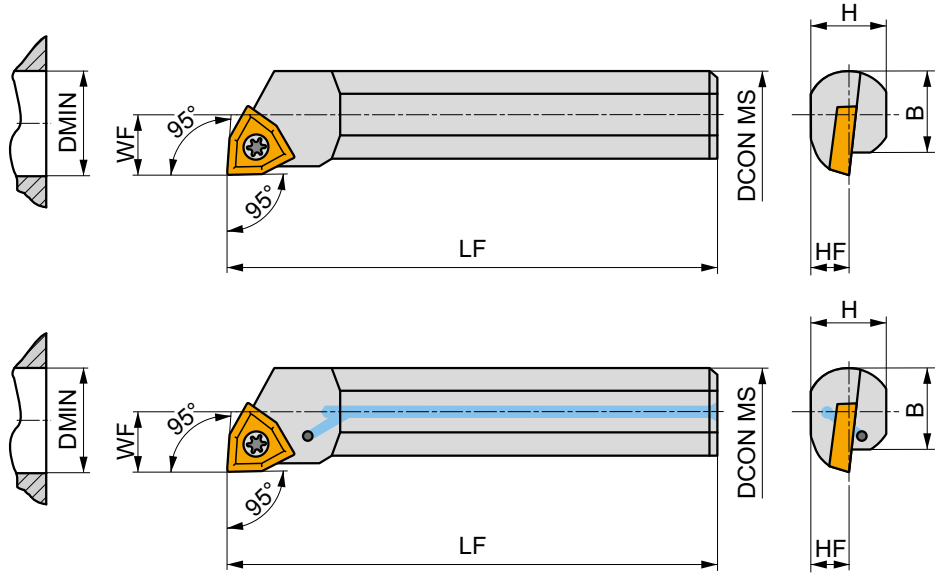
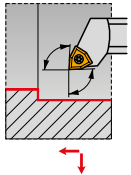

Codice prodotto	DCON MS	DMIN	WF	H	B	LF	LAMS	GAMO					
	(mm)	(mm)	(mm)	(mm)	(mm)	(mm)	(°)	(°)					
R	A20Q-SWLCR 06	20	25	13	18	18.5	180	-7	0	✓	0.37	GI055	S04
	S20S-SWLCR 06	20	25	13	18	18.5	250	-7	0	-	0.62	GI055	S04
	A25R-SWLCR 06	25	32	17	23	23	200	-7	0	✓	0.70	GI055	S04
	S25T-SWLCR 06	25	32	17	23	23	300	-7	0	-	1.15	GI055	S04
	A25R-SWLCR 08	25	32	17	23	23	200	-7	0	✓	0.70	GI049	S04
	A32S-SWLCR 08	32	40	22	30	30	250	-5	0	✓	1.32	GI049	S09
	S32U-SWLCR 08	32	40	22	30	30	350	-5	0	-	2.05	GI049	S09
	A20Q-SWLCR 06	20	25	13	18	18.5	180	-7	0	✓	0.00	GI055	S04
L	S20S-SWLCR 06	20	25	13	18	18.5	250	-7	0	-	0.60	GI055	S04
	A25R-SWLCR 06	25	32	17	23	23	200	-7	0	✓	0.70	GI055	S04
	S25T-SWLCR 06	25	32	17	23	23	300	-7	0	-	1.15	GI055	S04
	A25R-SWLCR 08	25	32	17	23	23	200	-7	0	✓	0.70	GI049	S04
	A32S-SWLCR 08	32	40	22	30	30	250	-5	0	✓	1.32	GI049	S09
	S32U-SWLCR 08	32	40	22	30	30	350	-5	0	-	4.10	GI049	S09

GI049	WC..0804..
GI055	WC..06T3..

S04	US 3510-T15P	3.0	M 3.5	10.6	FLAGT15P
S09	US 4512-T15P	5.0	M 4.5	12.2	FLAGT15P



SWUC(RL) INT



Utensile interno, bloccaggio a vite, inserti WC... angolo del tagliente utensile 93°

Bareno destro/sinistro per tornitura interna con bloccaggio a vite e passaggio refrigerante interno, angolo del tagliente utensile 93° per inserto positivo WC...0201. Diametro interno minimo tornibile $\varnothing 5.8$ mm. Adatto per operazioni di tornitura longitudinale, spallamento, conicità e smussi. Disponibile solamente con stelo $\varnothing 8$ mm. Corpo trattato per una maggiore durata.

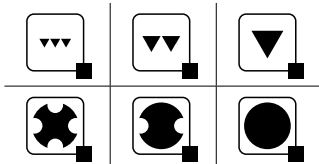
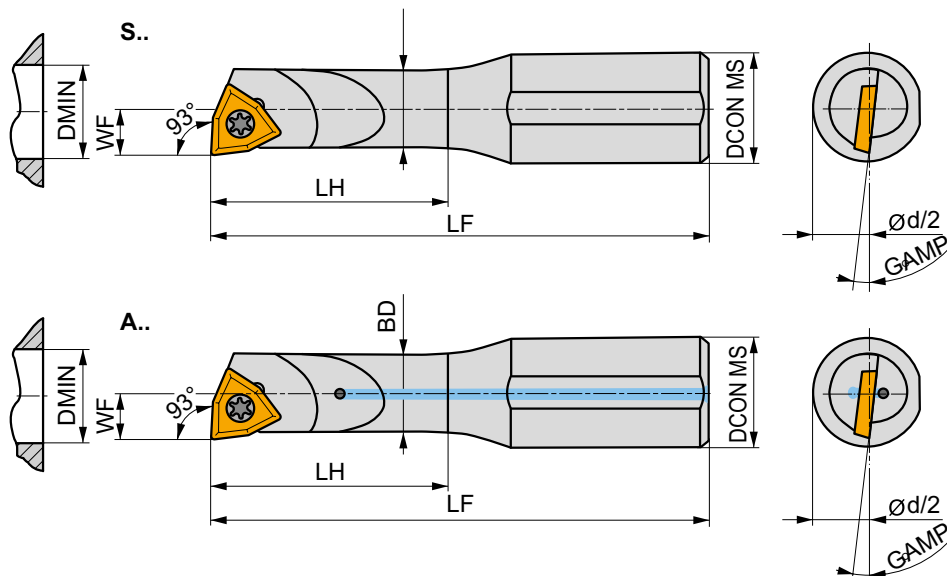
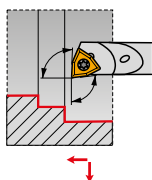

Codice prodotto	DCON MS	DMIN	BD	WF	LF	LH	GAMP				
	(mm)	(mm)	(mm)	(mm)	(mm)	(mm)	(°)				
R	A0508H-SWUCR 02	8	5.8	5	2.9	100	-17	✓	0.09	GI221	SW21
	S0508H-SWUCR 02	8	5.8	5	2.9	100	-17	–	0.04	GI221	SW21
	A0608H-SWUCR 02	8	7.8	6	3.9	100	-12	✓	0.04	GI221	SW21
	S0608H-SWUCR 02	8	7.8	6	3.9	100	-12	–	0.04	GI221	SW21
L	A0508H-SWUCL 02	8	5.8	5	2.9	100	-17	✓	0.04	GI221	SW21
	S0508H-SWUCL 02	8	5.8	5	2.9	100	-17	–	0.04	GI221	SW21
	A0608H-SWUCL 02	8	7.8	6	3.9	100	-12	✓	0.04	GI221	SW21
	S0608H-SWUCL 02	8	7.8	6	3.9	100	-12	–	0.04	GI221	SW21



GI221



WC.. 0201..



SW21



T20.037



0.6



M 2



3.7



DMD 1650



SWUC(RL)-E INT



PRAMET

S



Utensile interno in metallo duro, bloccaggio a vite, per inserto WC... angolo del tagliente utensile 93°

Bareno destro/sinistro in metallo duro per tornitura interna con bloccaggio a vite e passaggio refrigerante interno, angolo del tagliente utensile 93° per inserto positivo WC...0201. Diametro interno minimo tornibile Ø5.8 mm. Adatto per operazioni di tornitura longitudinale, spallamento, conicità e smussi. Disponibile con stelo da Ø5 mm a Ø8 mm. Per sporgenze utensile >3xD.

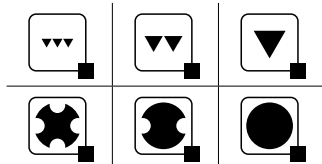
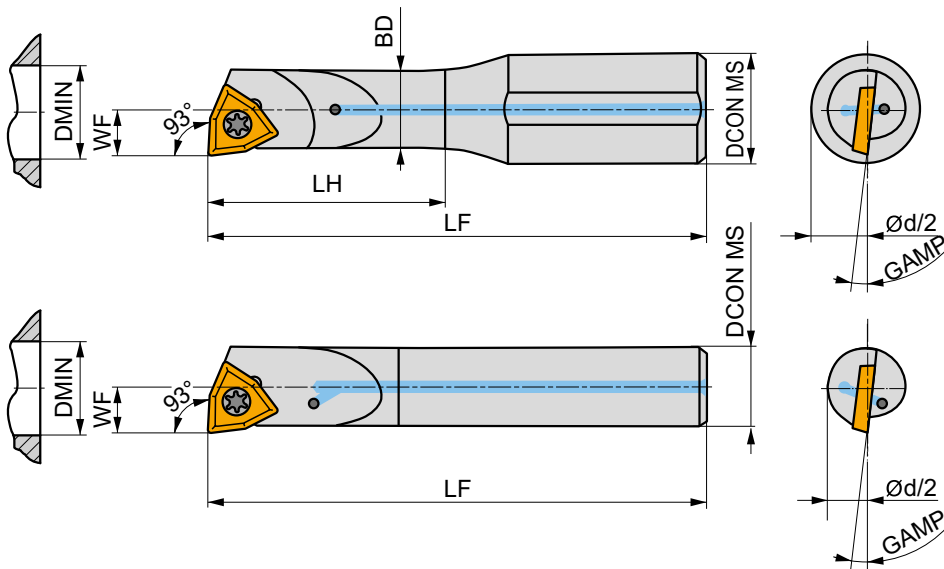
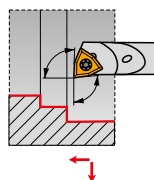

Codice prodotto	DCON MS (mm)	DMIN (mm)	BD (mm)	WF (mm)	LF (mm)	LH (mm)	GAMP (°)				
R E0508H-SWUCR 02	8	5.8	5	2.9	100	24	-17	✓	0.06	GI221	SW21
E05F-SWUCR 02	5	5.8	-	2.9	85	-	-17	✓	0.03	GI221	SW21
E0608H-SWUCR 02	8	7.8	6	3.9	100	32	-12	✓	0.06	GI221	SW21
E06G-SWUCR 02	6	7.8	-	3.9	95	-	-12	✓	0.04	GI221	SW21
L E0508H-SWUCL 02	8	5.8	5	2.9	100	24	-17	✓	0.07	GI221	SW21
E05F-SWUCL 02	5	5.8	-	2.9	85	-	-17	✓	0.03	GI221	SW21
E0608H-SWUCL 02	8	7.8	6	3.9	100	32	-12	✓	0.06	GI221	SW21
E06G-SWUCL 02	6	7.8	-	3.9	95	-	-12	✓	0.04	GI221	SW21

GI221 WC.. 0201..

SW21 T20.037 0.6 M 2 3.7 DMD 1650



INSERTI NEGATIVI



CN

09/ 12/ 16/ 19/ 25

INSERTI IN METALLO DURO

CNGG	CNMA	CNMG	CNMM
222	222	223	234

INSERTI CER E CBN

CNGA CER	CNGN CER	CNGA CBN
238	238	239

ABBINAMENTO DELLA DIMENSIONE CORRETTA (esempio)

Inserto	Portainsero
CNMM 120412E-OR	DCBNR 2525 M 12

TORNITURA ISO - ESTERNA

DCBN(RL) EXT		DCKN(RL) EXT		DCLN(RL) EXT		PCBN(RL) EXT	
75°	CN..	75°	CN..	95°	CN..	75°	CN..
12 16 19		12 16		09 12 16 19		12 16 19 25	
20×20 40×40		20×20 32×32		16×16 40×40		20×20 50×50	
240	222 – 239	242	222 – 239	243	222 – 239	245	222 – 239
PCLN(RL) EXT		PCKN(RL) EXT		C.-DCLN(RL) EXT NEW			
95°	CN..	75°	CN..	95°	CN..		
12 16 19 25		12 16 19		12 16 19			
20×20 50×50		20×20 40×40		C3 C8			
247	222 – 239	246	222 – 239	249	222 – 239		



CN

09/ 12/ 16/ 19/ 25

TORNITURA ISO - SGROSSATURA PESANTE - ESTERNA

KHP-CBNR + DKH(RL)

75°	CN..
25	
<small>DKHR+KHP-CBNR</small>	
	$\frac{40 \times 50}{60 \times 80}$
251, 253	222 - 239

KHP-CBNL + DKH(RL)

75°	CN..
25	
<small>DKHR+KHP-CBNL</small>	
	$\frac{40 \times 50}{60 \times 80}$
251, 253	222 - 239

KHP-CLNR/L + DKH(RL)

95°	CN..
19	
25	
<small>DKHR+KHP-CLNR</small>	
	$\frac{40 \times 50}{60 \times 80}$
252, 253	222 - 239

TORNITURA ISO INTERNA

DCLN(RL) INT

95°	CN..
09	
12	
	$\frac{32}{50}$
254	222 - 239

PCLN(RL) INT

95°	CN..
09	
12	
16	
19	
	$\frac{20}{80}$
255	222 - 239

C.-DCLN(RL) INT **NEW**

95°	CN..
09	
12	
16	
	$\frac{25}{50}$
257	222 - 239



CNGG

	IC	D1	L	S
	(mm)	(mm)	(mm)	(mm)
1204	12.700	5.16	12.90	4.76

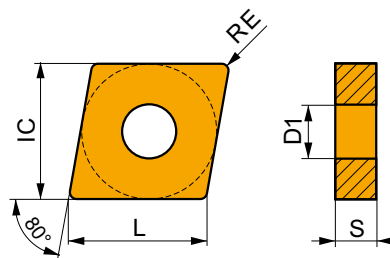

Idoneità e valori iniziali per velocità di taglio (Vc), avanzamento (f) e profondità di taglio (ap). Fare riferimento alla nostra App Machining Calculator per ulteriori calcoli.

Codice prodotto	RE	P			M			K			N			S			H		
		vc	f	ap	vc	f	ap	vc	f	ap	vc	f	ap	vc	f	ap	vc	f	ap
	(mm)	(m/min)	(mm/rev)	(mm)	(m/min)	(mm/rev)	(mm)	(m/min)	(mm/rev)	(mm)	(m/min)	(mm/rev)	(mm)	(m/min)	(mm/rev)	(mm)	(m/min)	(mm/rev)	(mm)

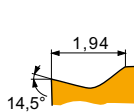

SF geometria con design positivo per operazioni di finitura su pareti sottili, taglio continuo.

CNGG 120402E-SF	H07	0.2	–	–	–	105	0.09	1.0	165	0.10	1.0	525	0.12	1.0	50	0.08	0.8	–	–	–
	T6310	0.2	195	0.10	1.0	140	0.09	1.0	155	0.10	1.0	585	0.12	1.0	55	0.08	0.8	35	0.15	1.0
	T8315	0.2	205	0.10	1.0	120	0.09	1.0	190	0.10	1.0	615	0.12	1.0	50	0.08	0.8	40	0.15	1.0
	T8330	0.2	195	0.10	1.0	115	0.09	1.0	185	0.10	1.0	585	0.12	1.0	45	0.08	0.8	35	0.15	1.0
	T8430	0.2	240	0.10	1.0	130	0.09	1.0	195	0.10	1.0	660	0.12	1.0	50	0.08	0.8	40	0.15	1.0

CNMA

	IC	D1	L	S
	(mm)	(mm)	(mm)	(mm)
1204	12.700	5.16	12.90	4.76
1606	15.875	6.35	16.10	6.35
1906	19.050	7.94	19.30	6.35

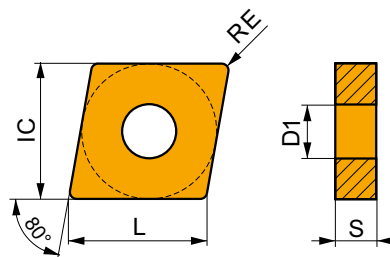

Idoneità e valori iniziali per velocità di taglio (Vc), avanzamento (f) e profondità di taglio (ap). Fare riferimento alla nostra App Machining Calculator per ulteriori calcoli.

Codice prodotto	RE	P			M			K			N			S			H		
		vc	f	ap	vc	f	ap	vc	f	ap	vc	f	ap	vc	f	ap	vc	f	ap
	(mm)	(m/min)	(mm/rev)	(mm)	(m/min)	(mm/rev)	(mm)	(m/min)	(mm/rev)	(mm)	(m/min)	(mm/rev)	(mm)	(m/min)	(mm/rev)	(mm)	(m/min)	(mm/rev)	(mm)

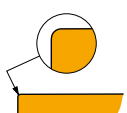
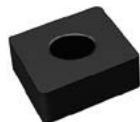

Adatta per operazioni da finitura fino a semi sgrassatura, da taglio continuo a leggermente interrotto.

CNMA 120404	T5305	0.4	–	–	–	–	–	–	235	0.10	4.0	–	–	–	–	–	–	50	0.15	1.0
	T5315	0.4	–	–	–	–	–	–	200	0.10	4.0	–	–	–	–	–	–	40	0.15	1.0
CNMA 120408	T5305	0.8	–	–	–	–	–	–	220	0.20	4.0	–	–	–	–	–	–	45	0.15	1.0
	T5315	0.8	–	–	–	–	–	–	190	0.20	4.0	–	–	–	–	–	–	40	0.15	1.0
CNMA 120412	T6310	0.8	–	–	–	–	–	–	100	0.20	4.0	–	–	–	–	–	–	25	0.15	1.0
	T5305	1.2	–	–	–	–	–	–	195	0.30	4.0	–	–	–	–	–	–	40	0.15	1.0
CNMA 120416	T5315	1.2	–	–	–	–	–	–	180	0.30	4.0	–	–	–	–	–	–	35	0.15	1.0
	T6310	1.2	–	–	–	–	–	–	95	0.30	4.0	–	–	–	–	–	–	20	0.15	1.0
CNMA 120416	T5305	1.6	–	–	–	–	–	–	190	0.40	4.0	–	–	–	–	–	–	40	0.15	1.0
	T5315	1.6	–	–	–	–	–	–	170	0.40	4.0	–	–	–	–	–	–	35	0.15	1.0



Idoneità e valori iniziali per velocità di taglio (Vc), avanzamento (f) e profondità di taglio (ap). Fare riferimento alla nostra App Machining Calculator per ulteriori calcoli.

Codice prodotto	RE (mm)	P			M			K			N			S			H		
		vc (m/min)	f (mm/rev)	ap (mm)	vc (m/min)	f (mm/rev)	ap (mm)	vc (m/min)	f (mm/rev)	ap (mm)	vc (m/min)	f (mm/rev)	ap (mm)	vc (m/min)	f (mm/rev)	ap (mm)	vc (m/min)	f (mm/rev)	ap (mm)

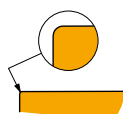
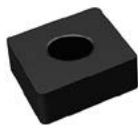

Adatta per operazioni da finitura fino a semi sgrossatura, da taglio continuo a leggermente interrotto.

CNMA 160612	T5305	1.2	–	–	–	–	–	–	190	0.30	5.0	–	–	–	–	–	–	40	0.15	1.0
	T5315	1.2	–	–	–	–	–	–	175	0.30	5.0	–	–	–	–	–	–	35	0.15	1.0
	T6310	1.2	–	–	–	–	–	–	90	0.30	5.0	–	–	–	–	–	–	20	0.15	1.0
CNMA 160616	T5305	1.6	–	–	–	–	–	–	185	0.40	5.0	–	–	–	–	–	–	35	0.15	1.0
	T5315	1.6	–	–	–	–	–	–	165	0.40	5.0	–	–	–	–	–	–	35	0.15	1.0
CNMA 190612	T5305	1.2	–	–	–	–	–	–	190	0.30	6.0	–	–	–	–	–	–	40	0.15	1.0
	T5315	1.2	–	–	–	–	–	–	170	0.30	6.0	–	–	–	–	–	–	35	0.15	1.0
	T6310	1.2	–	–	–	–	–	–	85	0.30	6.0	–	–	–	–	–	–	20	0.15	1.0
CNMA 190616	T5305	1.6	–	–	–	–	–	–	180	0.40	6.0	–	–	–	–	–	–	35	0.15	1.0
	T5315	1.6	–	–	–	–	–	–	160	0.40	6.0	–	–	–	–	–	–	30	0.15	1.0

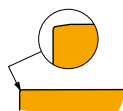
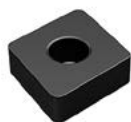

Adatta per operazioni da finitura fino a semi sgrossatura, da taglio continuo a leggermente interrotto.

CNMA 120408S	T5305	0.8	–	–	–	–	–	–	220	0.20	4.0	–	–	–	–	–	–	45	0.15	1.0
CNMA 120412S	T5305	1.2	–	–	–	–	–	–	190	0.40	4.0	–	–	–	–	–	–	40	0.15	1.0
CNMA 160612S	T5305	1.2	–	–	–	–	–	–	190	0.30	5.0	–	–	–	–	–	–	40	0.15	1.0
CNMA 190616S	T5305	1.6	–	–	–	–	–	–	180	0.40	6.0	–	–	–	–	–	–	35	0.15	1.0

CNMG

PRAMET

	IC (mm)	D1 (mm)	L (mm)	S (mm)
0903	9.525	3.81	9.70	3.18
1204	12.700	5.16	12.90	4.76
1606	15.880	6.35	16.10	6.35
1906	19.050	7.94	19.30	6.35
2509	25.400	9.12	25.80	9.53

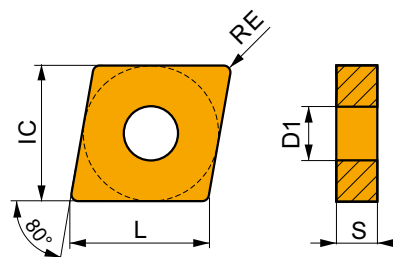

Idoneità e valori iniziali per velocità di taglio (Vc), avanzamento (f) e profondità di taglio (ap). Fare riferimento alla nostra App Machining Calculator per ulteriori calcoli.

Codice prodotto	RE (mm)	P			M			K			N			S			H		
		vc (m/min)	f (mm/rev)	ap (mm)	vc (m/min)	f (mm/rev)	ap (mm)	vc (m/min)	f (mm/rev)	ap (mm)	vc (m/min)	f (mm/rev)	ap (mm)	vc (m/min)	f (mm/rev)	ap (mm)	vc (m/min)	f (mm/rev)	ap (mm)

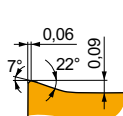
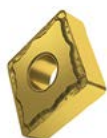

FF geometria altamente positiva per operazioni di super finitura, da taglio continuo a leggermente interrotto.

CNMG 120404E-FF	T7325	0.4	235	0.12	1.0	180	0.11	1.0	–	–	–	–	–	–	–	–	–	–	–
	T8315	0.4	220	0.12	1.0	130	0.11	1.0	205	0.12	1.0	–	–	–	–	–	–	–	–
CNMG 120408E-FF	T7325	0.8	265	0.15	1.0	205	0.14	1.0	–	–	–	–	–	–	–	–	–	–	–
	T8315	0.8	245	0.15	1.0	145	0.14	1.0	230	0.15	1.0	–	–	–	–	–	–	–	–



Idoneità e valori iniziali per velocità di taglio (Vc), avanzamento (f) e profondità di taglio (ap). Fare riferimento alla nostra App Machining Calculator per ulteriori calcoli.

Codice prodotto	RE (mm)	P			M			K			N			S			H		
		vc (m/min)	f (mm/rev)	ap (mm)	vc (m/min)	f (mm/rev)	ap (mm)	vc (m/min)	f (mm/rev)	ap (mm)	vc (m/min)	f (mm/rev)	ap (mm)	vc (m/min)	f (mm/rev)	ap (mm)	vc (m/min)	f (mm/rev)	ap (mm)

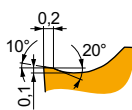

FM geometria positiva per operazioni da finitura fino a semi sgrossatura, da taglio continuo a leggermente interrotto.

CNMG 090304E-FM	T7325	0.4	195	0.20	1.4	150	0.18	1.4	—	—	—	60	0.16	1.1	—	—	—	
	T8330	0.4	175	0.20	1.4	105	0.18	1.4	165	0.20	1.4	40	0.14	1.1	—	—	—	
	T8430	0.4	195	0.20	1.4	105	0.18	1.4	160	0.20	1.4	40	0.14	1.1	—	—	—	
	T9315	0.4	265	0.20	1.4	—	—	—	250	0.20	1.4	—	—	—	—	—	—	—
	T9325	0.4	240	0.20	1.4	140	0.18	1.4	225	0.20	1.4	50	0.16	1.1	—	—	—	
CNMG 090308E-FM	T7325	0.8	235	0.20	1.4	180	0.18	1.4	—	—	—	75	0.16	1.1	—	—	—	
	T8330	0.8	205	0.20	1.4	120	0.18	1.4	190	0.20	1.4	50	0.14	1.1	—	—	—	
	T8430	0.8	235	0.20	1.4	125	0.18	1.4	190	0.20	1.4	50	0.14	1.1	—	—	—	
	T9315	0.8	315	0.20	1.4	—	—	—	295	0.20	1.4	—	—	—	—	—	—	
	T9325	0.8	285	0.20	1.4	170	0.18	1.4	270	0.20	1.4	60	0.16	1.1	—	—	—	
CNMG 120404E-FM	T7325	0.4	185	0.20	2.1	140	0.18	2.1	—	—	—	60	0.16	1.7	—	—	—	
	T7335	0.4	180	0.20	2.1	140	0.18	2.1	—	—	—	55	0.16	1.7	—	—	—	
	T8315	0.4	175	0.20	2.1	105	0.18	2.1	165	0.20	2.1	40	0.14	1.7	—	—	—	
	T8330	0.4	165	0.20	2.1	95	0.18	2.1	155	0.20	2.1	40	0.14	1.7	—	—	—	
	T8430	0.4	190	0.20	2.1	105	0.18	2.1	155	0.20	2.1	40	0.14	1.7	—	—	—	
	T9310	0.4	285	0.20	2.1	—	—	—	270	0.20	2.1	—	—	—	—	—	—	
	T9315	0.4	255	0.20	2.1	—	—	—	240	0.20	2.1	—	—	—	—	—	—	
	T9325	0.4	230	0.20	2.1	135	0.18	2.1	215	0.20	2.1	50	0.16	1.7	—	—	—	
CNMG 120408E-FM	TT310	0.4	260	0.20	2.1	155	0.18	2.1	—	—	—	—	—	—	—	—	—	
	T7325	0.8	220	0.20	2.1	170	0.18	2.1	—	—	—	70	0.16	1.7	—	—	—	
	T7335	0.8	215	0.20	2.1	165	0.18	2.1	—	—	—	65	0.16	1.7	—	—	—	
	T8315	0.8	205	0.20	2.1	120	0.18	2.1	190	0.20	2.1	50	0.16	1.7	—	—	—	
	T8330	0.8	195	0.20	2.1	115	0.18	2.1	185	0.20	2.1	45	0.16	1.7	—	—	—	
	T8430	0.8	225	0.20	2.1	120	0.18	2.1	185	0.20	2.1	45	0.16	1.7	—	—	—	
	T9310	0.8	335	0.20	2.1	—	—	—	315	0.20	2.1	—	—	—	—	—	—	
	T9315	0.8	305	0.20	2.1	—	—	—	285	0.20	2.1	—	—	—	—	—	—	
CNMG 120412E-FM	T9325	0.8	275	0.20	2.1	165	0.18	2.1	260	0.20	2.1	60	0.16	1.7	—	—	—	
	TT310	0.8	310	0.20	2.1	185	0.18	2.1	—	—	—	—	—	—	—	—	—	
	T7325	1.2	210	0.27	2.1	160	0.24	2.1	—	—	—	65	0.19	1.7	—	—	—	
	T9315	1.2	285	0.27	2.1	—	—	—	270	0.27	2.1	—	—	—	—	—	—	
T9325	1.2	255	0.27	2.1	150	0.24	2.1	240	0.27	2.1	55	0.19	1.7	—	—	—		

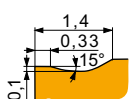

KR geometria per operazioni da semi sgrossatura fino a sgrossatura, da taglio continuo a interrotto.

CNMG 120408E-KR	T5305	0.8	255	0.35	4.0	—	—	—	240	0.35	4.0	—	—	—	50	0.15	1.0
	T5315	0.8	225	0.35	4.0	—	—	—	210	0.35	4.0	—	—	—	45	0.15	1.0
CNMG 120412E-KR	T5305	1.2	255	0.40	4.0	—	—	—	240	0.40	4.0	—	—	—	50	0.15	1.0
	T5315	1.2	230	0.40	4.0	—	—	—	215	0.40	4.0	—	—	—	45	0.15	1.0

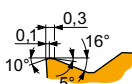

M geometria per operazioni da finitura fino a semi sgrossatura, da taglio continuo a interrotto.

CNMG 090308E-M	T9315	0.8	230	0.32	1.8	—	—	—	215	0.32	1.8	—	—	—	45	0.15	1.0
	T9325	0.8	205	0.32	1.8	—	—	—	190	0.32	1.8	—	—	—	—	—	—
	T9335	0.8	180	0.32	1.8	—	—	—	—	—	—	—	—	—	—	—	—
CNMG 120404E-M	T5315	0.4	245	0.20	2.1	—	—	—	230	0.20	2.1	—	—	—	45	0.15	1.0
	T9310	0.4	260	0.20	2.1	—	—	—	245	0.20	2.1	—	—	—	50	0.15	1.0
	T9315	0.4	235	0.20	2.1	—	—	—	220	0.20	2.1	—	—	—	45	0.15	1.0
	T9325	0.4	210	0.20	2.1	—	—	—	195	0.20	2.1	—	—	—	—	—	—
	T9335	0.4	180	0.20	2.1	—	—	—	—	—	—	—	—	—	—	—	—



Idoneità e valori iniziali per velocità di taglio (Vc), avanzamento (f) e profondità di taglio (ap). Fare riferimento alla nostra App Machining Calculator per ulteriori calcoli.

Codice prodotto	RE (mm)	P			M			K			N			S			H		
		vc (m/min)	f (mm/rev)	ap (mm)	vc (m/min)	f (mm/rev)	ap (mm)	vc (m/min)	f (mm/rev)	ap (mm)	vc (m/min)	f (mm/rev)	ap (mm)	vc (m/min)	f (mm/rev)	ap (mm)	vc (m/min)	f (mm/rev)	ap (mm)

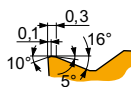

M geometria per operazioni da finitura fino a semi sgrossatura, da taglio continuo a interrotto.

CNMG 120408E-M	6640	0.8	█	165	0.32	2.1	-	-	-	█	155	0.32	2.1	-	-	-	-	-	-	-	-	
	T5305	0.8	█	280	0.32	2.1	-	-	-	█	265	0.32	2.1	-	-	-	-	-	█	55	0.15	1.0
	T5315	0.8	█	250	0.32	2.1	-	-	-	█	235	0.32	2.1	-	-	-	-	-	█	50	0.15	1.0
	T8330	0.8	█	155	0.32	2.1	-	-	-	█	145	0.32	2.1	-	-	-	-	-	█	30	0.15	1.0
	T8430	0.8	█	170	0.32	2.1	-	-	-	█	135	0.32	2.1	-	-	-	-	-	█	25	0.15	1.0
	T9310	0.8	█	245	0.32	2.1	-	-	-	█	230	0.32	2.1	-	-	-	-	-	█	45	0.15	1.0
	T9315	0.8	█	225	0.32	2.1	-	-	-	█	210	0.32	2.1	-	-	-	-	-	█	45	0.15	1.0
	T9325	0.8	█	200	0.32	2.1	-	-	-	█	190	0.32	2.1	-	-	-	-	-	-	-	-	-
	T9335	0.8	█	180	0.32	2.1	-	-	-	-	-	-	-	-	-	-	-	-	-	-	-	
CNMG 120412E-M	T5305	1.2	█	275	0.40	2.1	-	-	-	█	260	0.40	2.1	-	-	-	-	-	█	55	0.15	1.0
	T5315	1.2	█	245	0.40	2.1	-	-	-	█	230	0.40	2.1	-	-	-	-	-	█	45	0.15	1.0
	T9310	1.2	█	235	0.40	2.1	-	-	-	█	220	0.40	2.1	-	-	-	-	-	█	45	0.15	1.0
	T9315	1.2	█	220	0.40	2.1	-	-	-	█	205	0.40	2.1	-	-	-	-	-	█	40	0.15	1.0
	T9325	1.2	█	195	0.40	2.1	-	-	-	█	185	0.40	2.1	-	-	-	-	-	-	-	-	
CNMG 120416E-M	T9325	1.6	█	200	0.40	2.1	-	-	-	█	190	0.40	2.1	-	-	-	-	-	-	-	-	
	T9335	1.6	█	175	0.40	2.1	-	-	-	-	-	-	-	-	-	-	-	-	-	-		
CNMG 160608E-M	T9310	0.8	█	235	0.32	3.6	-	-	-	█	220	0.32	3.6	-	-	-	-	-	█	45	0.15	1.0
	T9315	0.8	█	215	0.32	3.6	-	-	-	█	200	0.32	3.6	-	-	-	-	-	█	40	0.15	1.0
	T9325	0.8	█	190	0.32	3.6	-	-	-	█	180	0.32	3.6	-	-	-	-	-	-	-	-	
	T9335	0.8	█	170	0.32	3.6	-	-	-	-	-	-	-	-	-	-	-	-	-	-		
CNMG 160612E-M	T9315	1.2	█	210	0.40	3.6	-	-	-	█	195	0.40	3.6	-	-	-	-	-	█	40	0.15	1.0
	T9325	1.2	█	185	0.40	3.6	-	-	-	█	175	0.40	3.6	-	-	-	-	-	-	-		
	T9335	1.2	█	160	0.40	3.6	-	-	-	-	-	-	-	-	-	-	-	-	-			
CNMG 160616E-M	T9325	1.6	█	190	0.40	3.6	-	-	-	█	180	0.40	3.6	-	-	-	-	-	-	-		
	T9335	1.6	█	165	0.40	3.6	-	-	-	-	-	-	-	-	-	-	-	-	-			
CNMG 190608E-M	T9315	0.8	█	210	0.32	4.2	-	-	-	█	195	0.32	4.2	-	-	-	-	-	█	40	0.15	1.0
	T9325	0.8	█	190	0.32	4.2	-	-	-	█	180	0.32	4.2	-	-	-	-	-	-	-		
	T9335	0.8	█	165	0.32	4.2	-	-	-	-	-	-	-	-	-	-	-	-	-			
CNMG 190612E-M	6640	1.2	█	145	0.40	4.2	-	-	-	█	135	0.40	4.2	-	-	-	-	-	-	-		
	T9310	1.2	█	220	0.40	4.2	-	-	-	█	205	0.40	4.2	-	-	-	-	-	█	40	0.15	1.0
	T9315	1.2	█	205	0.40	4.2	-	-	-	█	190	0.40	4.2	-	-	-	-	-	█	40	0.15	1.0
	T9325	1.2	█	185	0.40	4.2	-	-	-	█	175	0.40	4.2	-	-	-	-	-	-	-		
CNMG 190616E-M	T9310	1.6	█	230	0.40	4.2	-	-	-	█	215	0.40	4.2	-	-	-	-	-	█	45	0.15	1.0
	T9315	1.6	█	215	0.40	4.2	-	-	-	█	200	0.40	4.2	-	-	-	-	-	█	40	0.15	1.0
	T9325	1.6	█	190	0.40	4.2	-	-	-	█	180	0.40	4.2	-	-	-	-	-	-	-		
	T9335	1.6	█	165	0.40	4.2	-	-	-	-	-	-	-	-	-	-	-	-	-			

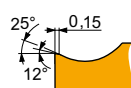

NF geometria con design altamente positivo per operazioni da finitura fino a medie lavorazioni, taglio continuo.

CNMG 090304E-NF	T6310	0.4	█	190	0.17	0.8	█	135	0.15	0.8	█	150	0.17	0.8	█	570	0.20	0.8	█	55	0.12	0.6	-	-	-
	T7335	0.4	█	210	0.18	0.8	█	160	0.16	0.8	-	-	-	-	-	-	-	-	█	65	0.16	0.6	-	-	-
	T8315	0.4	█	200	0.17	0.8	█	120	0.15	0.8	█	190	0.17	0.8	█	600	0.20	0.8	█	50	0.12	0.6	-	-	-
	T8430	0.4	█	225	0.17	0.8	█	120	0.15	0.8	█	185	0.17	0.8	█	615	0.20	0.8	█	45	0.12	0.6	-	-	-
	T9325	0.4	█	265	0.18	0.8	█	155	0.16	0.8	█	250	0.18	0.8	-	-	-	-	█	55	0.16	0.6	-	-	-
CNMG 090308E-NF	T6310	0.8	█	215	0.19	1.0	█	150	0.17	1.0	█	170	0.19	1.0	█	645	0.23	1.0	█	60	0.15	0.8	-	-	-
	T7335	0.8	█	240	0.19	1.0	█	185	0.17	1.0	-	-	-	-	-	-	-	-	█	75	0.15	0.8	-	-	-
	T8330	0.8	█	215	0.19	1.0	█	125	0.17	1.0	█	200	0.19	1.0	█	645	0.23	1.0	█	50	0.15	0.8	-	-	-
	T8430	0.8	█	245	0.19	1.0	█	135	0.17	1.0	█	200	0.19	1.0	█	675	0.23	1.0	█	50	0.15	0.8	-	-	-
	T9325	0.8	█	300	0.19	1.0	█	180	0.17	1.0	█	285	0.19	1.0	-	-	-	-	█	65	0.15	0.8	-	-	-



Idoneità e valori iniziali per velocità di taglio (Vc), avanzamento (f) e profondità di taglio (ap). Fare riferimento alla nostra App Machining Calculator per ulteriori calcoli.

Codice prodotto	RE (mm)	P			M			K			N			S			H		
		vc	f	ap	vc	f	ap	vc	f	ap	vc	f	ap	vc	f	ap	vc	f	ap
		(m/min)	(mm/rev)	(mm)	(m/min)	(mm/rev)	(mm)	(m/min)	(mm/rev)	(mm)	(m/min)	(mm/rev)	(mm)	(m/min)	(mm/rev)	(mm)	(m/min)	(mm/rev)	(mm)

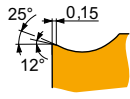

NF geometria con design altamente positivo per operazioni da finitura fino a medie lavorazioni, taglio continuo.

CNMG 120404E-NF	HF7	0.4	–	–	–	95	0.15	1.7	155	0.17	1.7	495	0.20	1.7	–	–	–	–	–	–
	T6310	0.4	180	0.17	1.7	125	0.15	1.7	145	0.17	1.7	540	0.20	1.7	50	0.14	1.4	–	–	–
	T7325	0.4	200	0.18	1.7	155	0.16	1.7	–	–	–	–	–	–	65	0.16	1.4	–	–	–
	T7335	0.4	195	0.18	1.7	150	0.16	1.7	–	–	–	–	–	–	60	0.16	1.4	–	–	–
	T8315	0.4	185	0.17	1.7	110	0.15	1.7	175	0.17	1.7	555	0.20	1.7	45	0.14	1.4	–	–	–
	T8330	0.4	180	0.17	1.7	105	0.15	1.7	170	0.17	1.7	540	0.20	1.7	45	0.14	1.4	–	–	–
	T8430	0.4	200	0.17	1.7	110	0.15	1.7	165	0.17	1.7	555	0.20	1.7	40	0.14	1.4	–	–	–
	T9315	0.4	285	0.17	1.7	–	–	–	270	0.17	1.7	–	–	–	–	–	–	–	–	–
	T9325	0.4	250	0.18	1.7	150	0.16	1.7	235	0.18	1.7	–	–	–	55	0.16	1.4	–	–	–
	CNMG 120408E-NF	HF7	0.8	–	–	–	110	0.17	1.7	180	0.19	1.7	570	0.23	1.7	–	–	–	–	–
T6310		0.8	200	0.19	1.7	140	0.17	1.7	160	0.19	1.7	600	0.23	1.7	60	0.15	1.4	–	–	–
T7325		0.8	235	0.19	1.7	180	0.17	1.7	–	–	–	–	–	75	0.15	1.4	–	–	–	
T7335		0.8	225	0.19	1.7	175	0.17	1.7	–	–	–	–	–	70	0.15	1.4	–	–	–	
T8315		0.8	215	0.19	1.7	125	0.17	1.7	200	0.19	1.7	645	0.23	1.7	50	0.15	1.4	–	–	–
T8330		0.8	200	0.19	1.7	120	0.17	1.7	190	0.19	1.7	600	0.23	1.7	50	0.15	1.4	–	–	–
T8430		0.8	235	0.19	1.7	125	0.17	1.7	190	0.19	1.7	645	0.23	1.7	50	0.15	1.4	–	–	–
T9315		0.8	320	0.19	1.7	–	–	–	300	0.19	1.7	–	–	–	–	–	–	–	–	–
T9325		0.8	285	0.19	1.7	170	0.17	1.7	270	0.19	1.7	–	–	–	60	0.15	1.4	–	–	–
CNMG 120412E-NF		T6310	1.2	185	0.30	2.1	130	0.27	2.1	145	0.30	2.1	555	0.36	2.1	55	0.21	1.7	–	–
	T7325	1.2	205	0.30	2.1	155	0.27	2.1	–	–	–	–	–	65	0.21	1.7	–	–	–	
	T7335	1.2	200	0.30	2.1	155	0.27	2.1	–	–	–	–	–	65	0.21	1.7	–	–	–	
	T8330	1.2	185	0.30	2.1	110	0.27	2.1	175	0.30	2.1	555	0.36	2.1	45	0.21	1.7	–	–	–
	T8430	1.2	200	0.30	2.1	110	0.27	2.1	165	0.30	2.1	555	0.36	2.1	40	0.21	1.7	–	–	–
	T9315	1.2	275	0.30	2.1	–	–	–	260	0.30	2.1	–	–	–	–	–	–	–	–	–
	T9325	1.2	245	0.30	2.1	145	0.27	2.1	230	0.30	2.1	–	–	–	55	0.21	1.7	–	–	–

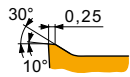

NM geometria con design altamente positivo per operazioni di finitura, media sgrassatura, taglio continuo.

CNMG 120404E-NM	T7325	0.4	195	0.20	2.1	150	0.18	2.1	–	–	–	–	–	–	60	0.16	1.7	–	–	–
	T7335	0.4	190	0.20	2.1	145	0.18	2.1	–	–	–	–	–	–	60	0.16	1.7	–	–	–
	T8315	0.4	180	0.20	2.1	105	0.18	2.1	–	–	–	540	0.24	2.1	45	0.16	1.7	–	–	–
	T8330	0.4	170	0.20	2.1	100	0.18	2.1	–	–	–	510	0.24	2.1	40	0.16	1.7	–	–	–
	T8430	0.4	195	0.20	2.1	105	0.18	2.1	–	–	–	540	0.24	2.1	40	0.16	1.7	–	–	–
	T9315	0.4	270	0.20	2.1	–	–	–	–	–	–	–	–	–	–	–	–	–	–	–
	T9325	0.4	240	0.20	2.1	140	0.18	2.1	–	–	–	–	–	–	50	0.16	1.7	–	–	–
CNMG 120408E-NM	T7325	0.8	215	0.25	2.1	165	0.23	2.1	–	–	–	–	–	–	65	0.20	1.7	–	–	–
	T7335	0.8	210	0.25	2.1	160	0.23	2.1	–	–	–	–	–	–	65	0.20	1.7	–	–	–
	T8315	0.8	205	0.25	2.1	120	0.23	2.1	–	–	–	615	0.30	2.1	50	0.20	1.7	–	–	–
	T8330	0.8	195	0.25	2.1	115	0.23	2.1	–	–	–	585	0.30	2.1	45	0.20	1.7	–	–	–
	T8430	0.8	210	0.25	2.1	115	0.23	2.1	–	–	–	585	0.30	2.1	45	0.20	1.7	–	–	–
	T9315	0.8	290	0.25	2.1	–	–	–	–	–	–	–	–	–	–	–	–	–	–	–
	T9325	0.8	260	0.25	2.1	155	0.23	2.1	–	–	–	–	–	–	55	0.20	1.7	–	–	–
CNMG 120412E-NM	T7325	1.2	215	0.30	2.1	165	0.27	2.1	–	–	–	–	–	–	65	0.24	1.7	–	–	–
	T7335	1.2	210	0.30	2.1	160	0.27	2.1	–	–	–	–	–	–	65	0.24	1.7	–	–	–
	T8315	1.2	205	0.30	2.1	120	0.27	2.1	–	–	–	615	0.36	2.1	50	0.24	1.7	–	–	–
	T8330	1.2	195	0.30	2.1	115	0.27	2.1	–	–	–	585	0.36	2.1	45	0.24	1.7	–	–	–
	T8430	1.2	210	0.30	2.1	115	0.27	2.1	–	–	–	585	0.36	2.1	45	0.24	1.7	–	–	–
	T9315	1.2	285	0.30	2.1	–	–	–	–	–	–	–	–	–	–	–	–	–	–	–
	T9325	1.2	255	0.30	2.1	150	0.27	2.1	–	–	–	–	–	–	55	0.24	1.7	–	–	–
CNMG 160608E-NM	T7325	0.8	195	0.30	3.6	150	0.27	3.6	–	–	–	–	–	–	60	0.27	2.9	–	–	–
	T7335	0.8	190	0.30	3.6	145	0.27	3.6	–	–	–	–	–	–	60	0.27	2.9	–	–	–
	T8315	0.8	185	0.30	3.6	110	0.27	3.6	–	–	–	555	0.36	3.6	45	0.27	2.9	–	–	–
	T8330	0.8	170	0.30	3.6	100	0.27	3.6	–	–	–	510	0.36	3.6	40	0.27	2.9	–	–	–
	T8430	0.8	185	0.30	3.6	100	0.27	3.6	–	–	–	510	0.36	3.6	40	0.27	2.9	–	–	–
	T9325	0.8	225	0.30	3.6	135	0.27	3.6	–	–	–	–	–	–	50	0.27	2.9	–	–	–



Idoneità e valori iniziali per velocità di taglio (Vc), avanzamento (f) e profondità di taglio (ap). Fare riferimento alla nostra App Machining Calculator per ulteriori calcoli.

Codice prodotto	RE (mm)	P			M			K			N			S			H		
		vc (m/min)	f (mm/rev)	ap (mm)	vc (m/min)	f (mm/rev)	ap (mm)	vc (m/min)	f (mm/rev)	ap (mm)	vc (m/min)	f (mm/rev)	ap (mm)	vc (m/min)	f (mm/rev)	ap (mm)	vc (m/min)	f (mm/rev)	ap (mm)

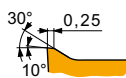

NM geometria con design altamente positivo per operazioni di finitura, media sgrassatura, taglio continuo.

CNMG 160612E-NM	T7325	1.2	205	0.30	3.6	155	0.27	3.6	-	-	-	-	-	-	65	0.27	2.9	-	-	-
	T7335	1.2	200	0.30	3.6	155	0.27	3.6	-	-	-	-	-	-	65	0.27	2.9	-	-	-
	T8315	1.2	195	0.30	3.6	115	0.27	3.6	-	-	-	585	0.36	3.6	45	0.27	2.9	-	-	-
	T9325	1.2	240	0.30	3.6	140	0.27	3.6	-	-	-	-	-	-	50	0.27	2.9	-	-	-
CNMG 190612E-NM	T7325	1.2	195	0.35	4.2	150	0.32	4.2	-	-	-	-	-	-	60	0.32	3.4	-	-	-
	T7335	1.2	180	0.35	4.2	140	0.32	4.2	-	-	-	-	-	-	55	0.32	3.4	-	-	-
	T8315	1.2	180	0.35	4.2	105	0.32	4.2	-	-	-	540	0.42	4.2	45	0.32	3.4	-	-	-
	T8330	1.2	170	0.35	4.2	100	0.32	4.2	-	-	-	510	0.42	4.2	40	0.32	3.4	-	-	-
	T8430	1.2	180	0.35	4.2	95	0.32	4.2	-	-	-	495	0.42	4.2	35	0.32	3.4	-	-	-
	T9325	1.2	220	0.35	4.2	130	0.32	4.2	-	-	-	-	-	-	45	0.32	3.4	-	-	-

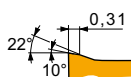

NMR geometria con design positivo per operazioni da media fino a sgrassatura, taglio continuo.

CNMG 090308E-NMR	T7325	0.8	175	0.35	1.6	135	0.32	1.6	-	-	-	-	-	-	55	0.25	1.3	-	-	-	
	T7335	0.8	170	0.35	1.6	130	0.32	1.6	-	-	-	-	-	-	55	0.25	1.3	-	-	-	
	T9325	0.8	200	0.35	1.6	120	0.32	1.6	-	-	-	-	-	-	45	0.25	1.3	-	-	-	
CNMG 120404E-NMR	T6310	0.4	140	0.25	2.7	100	0.23	2.7	-	-	-	-	-	-	40	0.20	2.2	-	-	-	
	T7325	0.4	155	0.25	2.7	120	0.23	2.7	-	-	-	-	-	-	50	0.20	2.2	-	-	-	
	T7335	0.4	155	0.25	2.0	120	0.23	2.0	-	-	-	-	-	-	50	0.20	1.6	-	-	-	
	T8330	0.4	140	0.25	2.0	80	0.23	2.0	-	-	-	-	-	-	35	0.20	1.6	-	-	-	
	T8430	0.4	150	0.25	2.7	80	0.23	2.7	-	-	-	-	-	-	30	0.20	2.2	-	-	-	
	T9315	0.4	215	0.25	2.0	-	-	-	-	-	-	-	-	-	-	-	-	-	-	-	-
	T9325	0.4	190	0.25	2.0	110	0.23	2.0	-	-	-	-	-	-	40	0.20	1.6	-	-	-	
CNMG 120408E-NMR	T6310	0.8	150	0.35	2.7	105	0.32	2.7	-	-	-	-	-	-	45	0.25	2.2	-	-	-	
	T7325	0.8	170	0.35	2.7	130	0.32	2.7	-	-	-	-	-	-	55	0.25	2.2	-	-	-	
	T7335	0.8	160	0.35	2.7	120	0.32	2.7	-	-	-	-	-	-	50	0.25	2.2	-	-	-	
	T8330	0.8	150	0.35	2.7	90	0.32	2.7	-	-	-	-	-	-	35	0.25	2.2	-	-	-	
	T8430	0.8	155	0.35	2.7	85	0.32	2.7	-	-	-	-	-	-	30	0.25	2.2	-	-	-	
	T9315	0.8	210	0.35	2.7	-	-	-	-	-	-	-	-	-	-	-	-	-	-	-	-
	T9325	0.8	190	0.35	2.7	110	0.32	2.7	-	-	-	-	-	-	40	0.25	2.2	-	-	-	
CNMG 120412E-NMR	T6310	1.2	150	0.40	2.7	105	0.36	2.7	-	-	-	-	-	-	45	0.28	2.2	-	-	-	
	T7325	1.2	170	0.40	2.7	130	0.36	2.7	-	-	-	-	-	-	55	0.28	2.2	-	-	-	
	T7335	1.2	160	0.40	2.7	120	0.36	2.7	-	-	-	-	-	-	50	0.28	2.2	-	-	-	
	T8330	1.2	150	0.40	2.7	90	0.36	2.7	-	-	-	-	-	-	35	0.28	2.2	-	-	-	
	T8430	1.2	155	0.40	2.7	85	0.36	2.7	-	-	-	-	-	-	30	0.28	2.2	-	-	-	
CNMG 120416E-NMR	T9315	1.2	215	0.40	2.7	-	-	-	-	-	-	-	-	-	-	-	-	-	-	-	
	T9325	1.2	190	0.40	2.7	110	0.36	2.7	-	-	-	-	-	-	40	0.28	2.2	-	-	-	
	T7325	1.6	170	0.45	2.7	130	0.41	2.7	-	-	-	-	-	-	55	0.32	2.2	-	-	-	
	T7335	1.6	160	0.45	2.7	120	0.41	2.7	-	-	-	-	-	-	50	0.32	2.2	-	-	-	
CNMG 160608E-NMR	T9325	1.6	190	0.45	2.7	110	0.41	2.7	-	-	-	-	-	-	40	0.32	2.2	-	-	-	
	T7325	0.8	160	0.35	4.0	120	0.32	4.0	-	-	-	-	-	-	50	0.25	3.2	-	-	-	
	T7335	0.8	150	0.35	4.0	115	0.32	4.0	-	-	-	-	-	-	45	0.25	3.2	-	-	-	
	T9315	0.8	205	0.35	4.0	-	-	-	-	-	-	-	-	-	-	-	-	-	-	-	
CNMG 160612E-NMR	T9325	0.8	185	0.35	4.0	110	0.32	4.0	-	-	-	-	-	-	40	0.25	3.2	-	-	-	
	T7325	1.2	165	0.40	4.0	125	0.36	4.0	-	-	-	-	-	-	50	0.28	3.2	-	-	-	
	T7335	1.2	155	0.40	4.0	120	0.36	4.0	-	-	-	-	-	-	50	0.28	3.2	-	-	-	
	T8330	1.2	145	0.40	4.0	85	0.36	4.0	-	-	-	-	-	-	35	0.28	3.2	-	-	-	
	T8430	1.2	150	0.40	4.0	80	0.36	4.0	-	-	-	-	-	-	30	0.28	3.2	-	-	-	
	T9315	1.2	205	0.40	4.0	-	-	-	-	-	-	-	-	-	-	-	-	-	-	-	
	T9325	1.2	185	0.40	4.0	110	0.36	4.0	-	-	-	-	-	-	40	0.28	3.2	-	-	-	



Idoneità e valori iniziali per velocità di taglio (Vc), avanzamento (f) e profondità di taglio (ap). Fare riferimento alla nostra App Machining Calculator per ulteriori calcoli.

Codice prodotto	RE (mm)	P			M			K			N			S			H		
		vc (m/min)	f (mm/rev)	ap (mm)	vc (m/min)	f (mm/rev)	ap (mm)	vc (m/min)	f (mm/rev)	ap (mm)	vc (m/min)	f (mm/rev)	ap (mm)	vc (m/min)	f (mm/rev)	ap (mm)	vc (m/min)	f (mm/rev)	ap (mm)

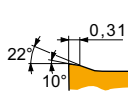

NMR geometria con design positivo per operazioni da media fino a sgrossatura, taglio continuo.

CNMG 160616E-NMR	T7325	1.6	165	0.45	4.0	125	0.41	4.0	-	-	-	-	-	-	50	0.32	3.2	-	-	-
	T7335	1.6	155	0.45	4.0	120	0.41	4.0	-	-	-	-	-	-	50	0.32	3.2	-	-	-
	T8330	1.6	145	0.45	4.0	85	0.41	4.0	-	-	-	-	-	-	35	0.32	3.2	-	-	-
	T8430	1.6	150	0.45	4.0	80	0.41	4.0	-	-	-	-	-	-	30	0.32	3.2	-	-	-
	T9315	1.6	200	0.45	4.0	-	-	-	-	-	-	-	-	-	-	-	-	-	-	-
CNMG 190608E-NMR	T9325	1.6	180	0.45	4.0	105	0.41	4.0	-	-	-	-	-	-	40	0.32	3.2	-	-	-
	T6310	0.8	140	0.35	5.2	100	0.32	5.2	-	-	-	-	-	-	40	0.25	4.2	-	-	-
	T7325	0.8	155	0.35	5.2	120	0.32	5.2	-	-	-	-	-	-	50	0.25	4.2	-	-	-
	T7335	0.8	150	0.35	5.2	115	0.32	5.2	-	-	-	-	-	-	45	0.25	4.2	-	-	-
	T9315	0.8	195	0.35	5.2	-	-	-	-	-	-	-	-	-	-	-	-	-	-	-
CNMG 190612E-NMR	T9325	0.8	180	0.35	5.2	105	0.32	5.2	-	-	-	-	-	-	40	0.25	4.2	-	-	-
	T6310	1.2	140	0.40	5.2	100	0.36	5.2	-	-	-	-	-	-	40	0.28	4.2	-	-	-
	T7325	1.2	160	0.40	5.2	120	0.36	5.2	-	-	-	-	-	-	50	0.28	4.2	-	-	-
	T7335	1.2	150	0.40	5.2	115	0.36	5.2	-	-	-	-	-	-	45	0.28	4.2	-	-	-
	T8330	1.2	140	0.40	5.2	80	0.36	5.2	-	-	-	-	-	-	35	0.28	4.2	-	-	-
	T8430	1.2	145	0.40	5.2	80	0.36	5.2	-	-	-	-	-	-	30	0.28	4.2	-	-	-
	T9315	1.2	200	0.40	5.2	-	-	-	-	-	-	-	-	-	-	-	-	-	-	-
CNMG 190616E-NMR	T9325	1.2	180	0.40	5.2	105	0.36	5.2	-	-	-	-	-	-	40	0.28	4.2	-	-	-
	T7325	1.6	160	0.45	5.2	120	0.41	5.2	-	-	-	-	-	-	50	0.32	4.2	-	-	-
	T7335	1.6	150	0.45	5.2	115	0.41	5.2	-	-	-	-	-	-	45	0.32	4.2	-	-	-
	T9315	1.6	195	0.45	5.2	-	-	-	-	-	-	-	-	-	-	-	-	-	-	-
	T9325	1.6	175	0.45	5.2	105	0.41	5.2	-	-	-	-	-	-	35	0.32	4.2	-	-	-

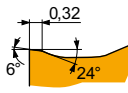

NRM geometria con design positivo per operazioni da semi sgrossatura fino a sgrossatura, da taglio continuo a moderatamente interrotto.

CNMG 120408-NRM	T7325	0.8	160	0.35	4.0	120	0.32	4.0	-	-	-	-	-	-	50	0.28	3.2	-	-	-
	T7335	0.8	150	0.35	4.0	115	0.32	4.0	-	-	-	-	-	-	45	0.28	3.2	-	-	-
	T9315	0.8	205	0.35	4.0	-	-	-	-	-	-	-	-	-	-	-	-	-	-	-
CNMG 120412-NRM	T7325	1.2	165	0.40	4.0	125	0.36	4.0	-	-	-	-	-	-	50	0.28	3.2	-	-	-
	T7335	1.2	155	0.40	4.0	120	0.36	4.0	-	-	-	-	-	-	50	0.28	3.2	-	-	-
	T9315	1.2	205	0.40	4.0	-	-	-	-	-	-	-	-	-	-	-	-	-	-	-
CNMG 120416-NRM	T7325	1.6	165	0.45	4.0	125	0.41	4.0	-	-	-	-	-	-	50	0.36	3.2	-	-	-
	T7335	1.6	155	0.45	4.0	120	0.41	4.0	-	-	-	-	-	-	50	0.36	3.2	-	-	-
	T9315	1.6	200	0.45	4.0	-	-	-	-	-	-	-	-	-	-	-	-	-	-	-
CNMG 160608-NRM	T7325	0.8	155	0.35	6.0	120	0.32	6.0	-	-	-	-	-	-	50	0.28	4.8	-	-	-
	T7335	0.8	145	0.35	6.0	110	0.32	6.0	-	-	-	-	-	-	45	0.28	4.8	-	-	-
	T9315	0.8	195	0.35	6.0	-	-	-	-	-	-	-	-	-	-	-	-	-	-	-
CNMG 160612-NRM	T7325	1.2	155	0.40	6.0	120	0.36	6.0	-	-	-	-	-	-	50	0.32	4.8	-	-	-
	T7335	1.2	150	0.40	6.0	115	0.36	6.0	-	-	-	-	-	-	45	0.32	4.8	-	-	-
	T9315	1.2	200	0.40	6.0	-	-	-	-	-	-	-	-	-	-	-	-	-	-	-
CNMG 160616-NRM	T7325	1.6	155	0.45	6.0	120	0.41	6.0	-	-	-	-	-	-	50	0.36	4.8	-	-	-
	T7335	1.6	150	0.45	6.0	115	0.41	6.0	-	-	-	-	-	-	45	0.36	4.8	-	-	-
	T9315	1.6	195	0.45	6.0	-	-	-	-	-	-	-	-	-	-	-	-	-	-	-
CNMG 190608-NRM	T7325	0.8	150	0.35	8.0	115	0.32	8.0	-	-	-	-	-	-	45	0.28	6.4	-	-	-
	T7335	0.8	140	0.35	8.0	105	0.32	8.0	-	-	-	-	-	-	45	0.28	6.4	-	-	-
	T9315	0.8	190	0.35	8.0	-	-	-	-	-	-	-	-	-	-	-	-	-	-	-
CNMG 190612-NRM	T7325	1.2	155	0.40	8.0	120	0.36	8.0	-	-	-	-	-	-	50	0.32	6.4	-	-	-
	T7335	1.2	145	0.40	8.0	110	0.36	8.0	-	-	-	-	-	-	45	0.32	6.4	-	-	-
	T9315	1.2	190	0.40	8.0	-	-	-	-	-	-	-	-	-	-	-	-	-	-	-
CNMG 190616-NRM	T7325	1.6	150	0.45	8.0	115	0.41	8.0	-	-	-	-	-	-	45	0.36	6.4	-	-	-
	T7335	1.6	145	0.45	8.0	110	0.41	8.0	-	-	-	-	-	-	45	0.36	6.4	-	-	-
	T9315	1.6	190	0.45	8.0	-	-	-	-	-	-	-	-	-	-	-	-	-	-	-
CNMG 250924-NRM	T7325	2.4	95	0.70	10.0	70	0.63	10.0	-	-	-	-	-	-	30	0.49	8.0	-	-	-
	T7335	2.4	90	0.70	10.0	70	0.63	10.0	-	-	-	-	-	-	25	0.49	8.0	-	-	-
	T9315	2.4	115	0.70	10.0	-	-	-	105	0.70	10.0	-	-	-	-	-	-	-	-	-



Idoneità e valori iniziali per velocità di taglio (Vc), avanzamento (f) e profondità di taglio (ap). Fare riferimento alla nostra App Machining Calculator per ulteriori calcoli.

Codice prodotto	RE  (mm)	P			M			K			N			S			H		
		vc (m/min)	f (mm/rev)	ap (mm)	vc (m/min)	f (mm/rev)	ap (mm)	vc (m/min)	f (mm/rev)	ap (mm)	vc (m/min)	f (mm/rev)	ap (mm)	vc (m/min)	f (mm/rev)	ap (mm)	vc (m/min)	f (mm/rev)	ap (mm)

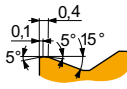

R geometria per operazioni da semi sgrossatura fino a sgrossatura, da taglio continuo a interrotto.

CNMG 120408E-R	6640	0.8	■	140	0.40	4.0	-	-	-	■	130	0.40	4.0	-	-	-	-	-	-			
	T5305	0.8	■	240	0.40	4.0	-	-	-	■	225	0.40	4.0	-	-	-	-	-	■	45	0.15	1.0
	T5315	0.8	■	215	0.40	4.0	-	-	-	■	200	0.40	4.0	-	-	-	-	-	■	40	0.15	1.0
	T9310	0.8	■	205	0.40	4.0	-	-	-	■	190	0.40	4.0	-	-	-	-	-	■	40	0.15	1.0
	T9315	0.8	■	190	0.40	4.0	-	-	-	■	180	0.40	4.0	-	-	-	-	-	■	35	0.15	1.0
	T9325	0.8	■	175	0.40	4.0	-	-	-	■	165	0.40	4.0	-	-	-	-	-	-	-	-	-
	T9335	0.8	■	150	0.40	4.0	-	-	-	-	-	-	-	-	-	-	-	-	-	-	-	
CNMG 120412E-R	T5305	1.2	■	245	0.45	4.0	-	-	-	■	230	0.45	4.0	-	-	-	-	-	■	45	0.15	1.0
	T5315	1.2	■	220	0.45	4.0	-	-	-	■	205	0.45	4.0	-	-	-	-	-	■	40	0.15	1.0
	T9315	1.2	■	195	0.45	4.0	-	-	-	■	185	0.45	4.0	-	-	-	-	-	■	35	0.15	1.0
	T9325	1.2	■	175	0.45	4.0	-	-	-	■	165	0.45	4.0	-	-	-	-	-	-	-	-	
	T9335	1.2	■	155	0.45	4.0	-	-	-	-	-	-	-	-	-	-	-	-	-	-		
CNMG 120416E-R	T5315	1.6	■	225	0.50	4.0	-	-	-	■	210	0.50	4.0	-	-	-	-	-	■	45	0.15	1.0
	T9335	1.6	■	150	0.50	4.0	-	-	-	-	-	-	-	-	-	-	-	-	-	-		
CNMG 160608E-R	T5315	0.8	■	210	0.40	5.5	-	-	-	■	195	0.40	5.5	-	-	-	-	-	■	40	0.15	1.0
CNMG 160612E-R	T5305	1.2	■	235	0.45	5.5	-	-	-	■	220	0.45	5.5	-	-	-	-	-	■	45	0.15	1.0
	T5315	1.2	■	215	0.45	5.5	-	-	-	■	200	0.45	5.5	-	-	-	-	-	■	40	0.15	1.0
	T7335	1.2	■	145	0.45	5.5	-	-	-	-	-	-	-	-	-	-	-	-	-	-		
	T9310	1.2	■	205	0.45	5.5	-	-	-	■	190	0.45	5.5	-	-	-	-	-	■	40	0.15	1.0
	T9315	1.2	■	190	0.45	5.5	-	-	-	■	180	0.45	5.5	-	-	-	-	-	■	35	0.15	1.0
	T9325	1.2	■	170	0.45	5.5	-	-	-	■	160	0.45	5.5	-	-	-	-	-	-	-	-	
	T9335	1.2	■	150	0.45	5.5	-	-	-	-	-	-	-	-	-	-	-	-	-	-		
CNMG 160616E-R	T5305	1.6	■	240	0.50	5.5	-	-	-	■	225	0.50	5.5	-	-	-	-	-	■	45	0.15	1.0
CNMG 190608E-R	T5315	0.8	■	205	0.40	7.0	-	-	-	■	190	0.40	7.0	-	-	-	-	-	■	40	0.15	1.0
CNMG 190612E-R	6640	1.2	■	135	0.45	7.0	-	-	-	■	125	0.45	7.0	-	-	-	-	-	-	-		
	T5305	1.2	■	230	0.45	7.0	-	-	-	■	215	0.45	7.0	-	-	-	-	-	■	45	0.15	1.0
	T5315	1.2	■	210	0.45	7.0	-	-	-	■	195	0.45	7.0	-	-	-	-	-	■	40	0.15	1.0
	T9315	1.2	■	185	0.45	7.0	-	-	-	■	175	0.45	7.0	-	-	-	-	-	■	35	0.15	1.0
	T9325	1.2	■	165	0.45	7.0	-	-	-	■	155	0.45	7.0	-	-	-	-	-	-	-		
	T9335	1.2	■	145	0.45	7.0	-	-	-	-	-	-	-	-	-	-	-	-	-			
CNMG 190616E-R	6640	1.6	■	130	0.50	7.0	-	-	-	■	120	0.50	7.0	-	-	-	-	-	-	-		
	T5305	1.6	■	235	0.50	7.0	-	-	-	■	220	0.50	7.0	-	-	-	-	-	■	45	0.15	1.0
	T5315	1.6	■	210	0.50	7.0	-	-	-	■	195	0.50	7.0	-	-	-	-	-	■	40	0.15	1.0
	T9310	1.6	■	195	0.50	7.0	-	-	-	■	185	0.50	7.0	-	-	-	-	-	■	35	0.15	1.0
	T9315	1.6	■	180	0.50	7.0	-	-	-	■	170	0.50	7.0	-	-	-	-	-	■	35	0.15	1.0
	T9325	1.6	■	165	0.50	7.0	-	-	-	■	155	0.50	7.0	-	-	-	-	-	-	-		
	T9335	1.6	■	145	0.50	7.0	-	-	-	-	-	-	-	-	-	-	-	-	-			

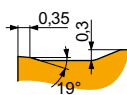



RM geometria per operazioni da semi sgrossatura fino a sgrossatura, da taglio continuo a interrotto.

CNMG 120408E-RM	T5305	0.8	■	275	0.40	4.0	-	-	-	■	260	0.40	4.0	-	-	-	-	-	-	
	T5315	0.8	■	250	0.40	4.0	-	-	-	■	235	0.40	4.0	-	-	-	-	-	-	
	T6310	0.8	■	155	0.40	4.0	■	110	0.36	4.0	■	125	0.40	4.0	-	-	-	-	-	
	T7325	0.8	■	180	0.40	4.0	■	140	0.36	4.0	-	-	-	-	-	-	-	-	-	
	T7335	0.8	■	165	0.40	4.0	■	125	0.36	4.0	-	-	-	-	-	-	-	-	-	
	T8315	0.8	■	165	0.40	4.0	■	95	0.36	4.0	■	155	0.40	4.0	-	-	-	-	-	-
	T8330	0.8	■	155	0.40	4.0	■	90	0.36	4.0	■	145	0.40	4.0	-	-	-	-	-	
	T8430	0.8	■	165	0.40	4.0	■	90	0.36	4.0	■	135	0.40	4.0	-	-	-	-	-	
	T9310	0.8	■	240	0.40	4.0	-	-	-	■	225	0.40	4.0	-	-	-	-	-	-	
	T9315	0.8	■	220	0.40	4.0	-	-	-	■	205	0.40	4.0	-	-	-	-	-	-	
	T9325	0.8	■	200	0.40	4.0	■	120	0.36	4.0	■	190	0.40	4.0	-	-	-	-	-	
	T9335	0.8	■	170	0.40	4.0	■	100	0.36	4.0	-	-	-	-	-	-	-	-	-	

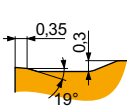

Idoneità e valori iniziali per velocità di taglio (Vc), avanzamento (f) e profondità di taglio (ap). Fare riferimento alla nostra App Machining Calculator per ulteriori calcoli.

Codice prodotto	RE  (mm)	P			M			K			N			S			H				
		vc	f	ap	vc	f	ap	vc	f	ap	vc	f	ap	vc	f	ap	vc	f	ap		
		(m/min)	(mm/rev)	(mm)	(m/min)	(mm/rev)	(mm)	(m/min)	(mm/rev)	(mm)	(m/min)	(mm/rev)	(mm)	(m/min)	(mm/rev)	(mm)	(m/min)	(mm/rev)	(mm)		
 	RE (mm)	RM geometria per operazioni da semi sgrossatura fino a sgrossatura, da taglio continuo a interrotto.																			
		T5305	1.2	280	0.45	4.0	-	-	-	265	0.45	4.0	-	-	-	-	-	-	-	-	-
		T5315	1.2	250	0.45	4.0	-	-	-	235	0.45	4.0	-	-	-	-	-	-	-	-	-
		T6310	1.2	160	0.45	4.0	115	0.41	4.0	125	0.45	4.0	-	-	-	-	-	-	-	-	-
		T7325	1.2	180	0.45	4.0	140	0.41	4.0	-	-	-	-	-	-	-	-	-	-	-	-
		T7335	1.2	170	0.45	4.0	130	0.41	4.0	-	-	-	-	-	-	-	-	-	-	-	-
		T8315	1.2	170	0.45	4.0	100	0.41	4.0	160	0.45	4.0	-	-	-	-	-	-	-	-	-
		T8330	1.2	160	0.45	4.0	95	0.41	4.0	150	0.45	4.0	-	-	-	-	-	-	-	-	-
		T8430	1.2	170	0.45	4.0	90	0.41	4.0	135	0.45	4.0	-	-	-	-	-	-	-	-	-
		T9310	1.2	240	0.45	4.0	-	-	-	225	0.45	4.0	-	-	-	-	-	-	-	-	-
		T9315	1.2	220	0.45	4.0	-	-	-	205	0.45	4.0	-	-	-	-	-	-	-	-	-
		T9325	1.2	200	0.45	4.0	120	0.41	4.0	190	0.45	4.0	-	-	-	-	-	-	-	-	-
T9335	1.2	175	0.45	4.0	105	0.41	4.0	-	-	-	-	-	-	-	-	-	-	-	-		
CNMG 120416E-RM	T5305	1.6	280	0.50	4.0	-	-	-	265	0.50	4.0	-	-	-	-	-	-	-	-	-	
	T5315	1.6	255	0.50	4.0	-	-	-	240	0.50	4.0	-	-	-	-	-	-	-	-	-	
	T7325	1.6	185	0.50	4.0	140	0.45	4.0	-	-	-	-	-	-	-	-	-	-	-		
	T7335	1.6	175	0.50	4.0	135	0.45	4.0	-	-	-	-	-	-	-	-	-	-	-	-	
	T8330	1.6	160	0.50	4.0	95	0.45	4.0	150	0.50	4.0	-	-	-	-	-	-	-	-	-	
	T8430	1.6	170	0.50	4.0	90	0.45	4.0	135	0.50	4.0	-	-	-	-	-	-	-	-	-	
	T9310	1.6	240	0.50	4.0	-	-	-	225	0.50	4.0	-	-	-	-	-	-	-	-	-	
	T9315	1.6	220	0.50	4.0	-	-	-	205	0.50	4.0	-	-	-	-	-	-	-	-	-	
	T9325	1.6	205	0.50	4.0	120	0.45	4.0	190	0.50	4.0	-	-	-	-	-	-	-	-	-	
T9335	1.6	175	0.50	4.0	105	0.45	4.0	-	-	-	-	-	-	-	-	-	-	-	-		
CNMG 160608E-RM	T5305	0.8	265	0.40	6.0	-	-	-	250	0.40	6.0	-	-	-	-	-	-	-	-	-	
	T5315	0.8	240	0.40	6.0	-	-	-	225	0.40	6.0	-	-	-	-	-	-	-	-	-	
	T8330	0.8	150	0.40	6.0	90	0.36	6.0	140	0.40	6.0	-	-	-	-	-	-	-	-		
	T8430	0.8	155	0.40	6.0	85	0.36	6.0	130	0.40	6.0	-	-	-	-	-	-	-	-		
	T9315	0.8	215	0.40	6.0	-	-	-	200	0.40	6.0	-	-	-	-	-	-	-	-		
	T9325	0.8	190	0.40	6.0	110	0.36	6.0	180	0.40	6.0	-	-	-	-	-	-	-	-		
	T9335	0.8	165	0.40	6.0	95	0.36	6.0	-	-	-	-	-	-	-	-	-	-	-		
CNMG 160612E-RM	T5305	1.2	270	0.45	6.0	-	-	-	255	0.45	6.0	-	-	-	-	-	-	-	-	-	
	T5315	1.2	245	0.45	6.0	-	-	-	230	0.45	6.0	-	-	-	-	-	-	-	-	-	
	T6310	1.2	155	0.45	6.0	110	0.41	6.0	125	0.45	6.0	-	-	-	-	-	-	-	-		
	T7325	1.2	170	0.45	6.0	130	0.41	6.0	-	-	-	-	-	-	-	-	-	-	-		
	T7335	1.2	165	0.45	6.0	125	0.41	6.0	-	-	-	-	-	-	-	-	-	-	-		
	T8330	1.2	155	0.45	6.0	90	0.41	6.0	145	0.45	6.0	-	-	-	-	-	-	-	-		
	T8430	1.2	155	0.45	6.0	85	0.41	6.0	130	0.45	6.0	-	-	-	-	-	-	-	-		
	T9310	1.2	230	0.45	6.0	-	-	-	215	0.45	6.0	-	-	-	-	-	-	-	-		
	T9315	1.2	215	0.45	6.0	-	-	-	200	0.45	6.0	-	-	-	-	-	-	-	-		
	T9325	1.2	195	0.45	6.0	115	0.41	6.0	185	0.45	6.0	-	-	-	-	-	-	-	-		
T9335	1.2	165	0.45	6.0	95	0.41	6.0	-	-	-	-	-	-	-	-	-	-	-			
CNMG 160616E-RM	T5305	1.6	270	0.50	6.0	-	-	-	255	0.50	6.0	-	-	-	-	-	-	-	-	-	
	T5315	1.6	245	0.50	6.0	-	-	-	230	0.50	6.0	-	-	-	-	-	-	-	-		
	T7325	1.6	175	0.50	6.0	135	0.45	6.0	-	-	-	-	-	-	-	-	-	-			
	T7335	1.6	165	0.50	6.0	125	0.45	6.0	-	-	-	-	-	-	-	-	-	-			
	T9310	1.6	225	0.50	6.0	-	-	-	210	0.50	6.0	-	-	-	-	-	-	-	-		
	T9315	1.6	215	0.50	6.0	-	-	-	200	0.50	6.0	-	-	-	-	-	-	-	-		
	T9325	1.6	190	0.50	6.0	110	0.45	6.0	180	0.50	6.0	-	-	-	-	-	-	-			
T9335	1.6	165	0.50	6.0	95	0.45	6.0	-	-	-	-	-	-	-	-	-	-				
CNMG 190608E-RM	T5305	0.8	260	0.40	7.5	-	-	-	245	0.40	7.5	-	-	-	-	-	-	-	-		
	T5315	0.8	230	0.40	7.5	-	-	-	215	0.40	7.5	-	-	-	-	-	-	-			
	T7335	0.8	155	0.40	7.5	120	0.36	7.5	-	-	-	-	-	-	-	-	-				
	T9315	0.8	210	0.40	7.5	-	-	-	195	0.40	7.5	-	-	-	-	-	-	-			
	T9325	0.8	190	0.40	7.5	110	0.36	7.5	180	0.40	7.5	-	-	-	-	-	-				
	T9335	0.8	160	0.40	7.5	95	0.36	7.5	-	-	-	-	-	-	-	-	-				



Idoneità e valori iniziali per velocità di taglio (Vc), avanzamento (f) e profondità di taglio (ap). Fare riferimento alla nostra App Machining Calculator per ulteriori calcoli.

Codice prodotto	RE  (mm)	P			M			K			N			S			H			
		vc	f	ap	vc	f	ap	vc	f	ap	vc	f	ap	vc	f	ap	vc	f	ap	
		(m/min)	(mm/rev)	(mm)	(m/min)	(mm/rev)	(mm)	(m/min)	(mm/rev)	(mm)	(m/min)	(mm/rev)	(mm)	(m/min)	(mm/rev)	(mm)	(m/min)	(mm/rev)	(mm)	
CNMG 190612E-RM	T5305	1.2	260	0.45	7.5	—	—	—	245	0.45	7.5	—	—	—	—	—	—	—	—	—
	T5315	1.2	240	0.45	7.5	—	—	—	225	0.45	7.5	—	—	—	—	—	—	—	—	—
	T6310	1.2	155	0.45	7.5	110	0.41	7.5	125	0.45	7.5	—	—	—	—	—	—	—	—	—
	T7325	1.2	170	0.45	7.5	130	0.41	7.5	—	—	—	—	—	—	—	—	—	—	—	—
	T7335	1.2	160	0.45	7.5	120	0.41	7.5	—	—	—	—	—	—	—	—	—	—	—	—
	T8330	1.2	155	0.45	7.5	90	0.41	7.5	145	0.45	7.5	—	—	—	—	—	—	—	—	—
	T8430	1.2	150	0.45	7.5	80	0.41	7.5	125	0.45	7.5	—	—	—	—	—	—	—	—	—
	T9310	1.2	220	0.45	7.5	—	—	—	205	0.45	7.5	—	—	—	—	—	—	—	—	—
	T9315	1.2	210	0.45	7.5	—	—	—	195	0.45	7.5	—	—	—	—	—	—	—	—	—
	T9325	1.2	185	0.45	7.5	110	0.41	7.5	175	0.45	7.5	—	—	—	—	—	—	—	—	—
T9335	1.2	165	0.45	7.5	95	0.41	7.5	—	—	—	—	—	—	—	—	—	—	—	—	
CNMG 190616E-RM	T5305	1.6	265	0.50	7.5	—	—	—	250	0.50	7.5	—	—	—	—	—	—	—	—	—
	T5315	1.6	240	0.50	7.5	—	—	—	225	0.50	7.5	—	—	—	—	—	—	—	—	—
	T6310	1.6	155	0.50	7.5	110	0.45	7.5	125	0.50	7.5	—	—	—	—	—	—	—	—	—
	T7325	1.6	175	0.50	7.5	135	0.45	7.5	—	—	—	—	—	—	—	—	—	—	—	—
	T7335	1.6	160	0.50	7.5	120	0.45	7.5	—	—	—	—	—	—	—	—	—	—	—	—
	T9310	1.6	225	0.50	7.5	—	—	—	210	0.50	7.5	—	—	—	—	—	—	—	—	—
	T9315	1.6	210	0.50	7.5	—	—	—	195	0.50	7.5	—	—	—	—	—	—	—	—	—
	T9325	1.6	190	0.50	7.5	110	0.45	7.5	180	0.50	7.5	—	—	—	—	—	—	—	—	—
T9335	1.6	160	0.50	7.5	95	0.45	7.5	—	—	—	—	—	—	—	—	—	—	—	—	
CNMG 250924E-RM	T7325	2.4	105	0.80	12.0	80	0.72	12.0	—	—	—	—	—	—	—	—	—	—	—	—
	T7335	2.4	100	0.80	12.0	75	0.72	12.0	—	—	—	—	—	—	—	—	—	—	—	—
	T9226	2.4	90	0.80	12.0	50	0.72	12.0	85	0.80	12.0	—	—	—	—	—	—	—	—	—
	T9315	2.4	120	0.80	12.0	—	—	—	110	0.80	12.0	—	—	—	—	—	—	—	—	—
	T9325	2.4	105	0.80	12.0	60	0.72	12.0	95	0.80	12.0	—	—	—	—	—	—	—	—	—
	T9335	2.4	85	0.80	12.0	50	0.72	12.0	—	—	—	—	—	—	—	—	—	—	—	—

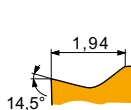

SF geometria con design positivo per operazioni di finitura su pareti sottili, taglio continuo.

CNMG 120404E-SF	H07	0.4	—	—	—	90	0.14	1.0	145	0.15	1.0	470	0.18	1.0	45	0.12	0.8	—	—	—
	T6310	0.4	180	0.15	1.0	125	0.14	1.0	145	0.15	1.0	540	0.18	1.0	50	0.12	0.8	35	0.15	1.0
	T7325	0.4	205	0.17	1.0	155	0.15	1.0	—	—	—	—	—	—	65	0.15	0.8	—	—	—
	T7335	0.4	200	0.17	1.0	155	0.15	1.0	—	—	—	—	—	—	65	0.15	0.8	—	—	—
	T8315	0.4	195	0.15	1.0	115	0.14	1.0	185	0.15	1.0	585	0.18	1.0	45	0.12	0.8	35	0.15	1.0
	T8330	0.4	180	0.15	1.0	105	0.14	1.0	170	0.15	1.0	540	0.18	1.0	45	0.12	0.8	35	0.15	1.0
	T8430	0.4	220	0.15	1.0	120	0.14	1.0	180	0.15	1.0	600	0.18	1.0	45	0.12	0.8	35	0.15	1.0
	T9315	0.4	300	0.15	1.0	—	—	—	285	0.15	1.0	—	—	—	—	—	—	60	0.15	1.0
	T9325	0.4	255	0.17	1.0	150	0.15	1.0	240	0.17	1.0	—	—	—	55	0.15	0.8	—	—	—
CNMG 120408E-SF	H07	0.8	—	—	—	95	0.18	1.0	155	0.20	1.0	495	0.24	1.0	50	0.14	0.8	—	—	—
	T6310	0.8	200	0.20	1.0	140	0.18	1.0	160	0.20	1.0	600	0.24	1.0	60	0.14	0.8	40	0.15	1.0
	T7325	0.8	230	0.20	1.0	175	0.18	1.0	—	—	—	—	—	—	70	0.16	0.8	—	—	—
	T7335	0.8	220	0.20	1.0	170	0.18	1.0	—	—	—	—	—	—	70	0.16	0.8	—	—	—
	T8315	0.8	210	0.20	1.0	125	0.18	1.0	195	0.20	1.0	630	0.24	1.0	50	0.14	0.8	40	0.15	1.0
	T8330	0.8	200	0.20	1.0	120	0.18	1.0	190	0.20	1.0	600	0.24	1.0	50	0.14	0.8	40	0.15	1.0
	T8430	0.8	230	0.20	1.0	125	0.18	1.0	185	0.20	1.0	630	0.24	1.0	45	0.14	0.8	35	0.15	1.0
	T9315	0.8	315	0.20	1.0	—	—	—	295	0.20	1.0	—	—	—	—	—	—	60	0.15	1.0
T9325	0.8	280	0.20	1.0	165	0.18	1.0	265	0.20	1.0	—	—	—	60	0.16	0.8	—	—	—	
CNMG 120412E-SF	T6310	1.2	190	0.25	1.5	135	0.23	1.5	150	0.25	1.5	570	0.30	1.5	55	0.18	1.2	35	0.15	1.0
	T7325	1.2	220	0.25	1.5	170	0.23	1.5	—	—	—	—	—	—	70	0.18	1.2	—	—	—
	T8315	1.2	200	0.25	1.5	120	0.23	1.5	190	0.25	1.5	600	0.30	1.5	50	0.18	1.2	40	0.15	1.0
	T8430	1.2	210	0.25	1.5	115	0.23	1.5	175	0.25	1.5	585	0.30	1.5	45	0.18	1.2	35	0.15	1.0



Idoneità e valori iniziali per velocità di taglio (Vc), avanzamento (f) e profondità di taglio (ap). Fare riferimento alla nostra App Machining Calculator per ulteriori calcoli.

Codice prodotto	RE  (mm)	P			M			K			N			S			H		
		vc (m/min)	f (mm/rev)	ap (mm)	vc (m/min)	f (mm/rev)	ap (mm)	vc (m/min)	f (mm/rev)	ap (mm)	vc (m/min)	f (mm/rev)	ap (mm)	vc (m/min)	f (mm/rev)	ap (mm)	vc (m/min)	f (mm/rev)	ap (mm)

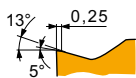

SM geometria con design positivo per medie lavorazioni, da taglio continuo a interrotto.

CNMG 120404E-SM	T6310 0.4	155	0.22	2.0	110	0.20	2.0	125	0.22	2.0	465	0.26	2.0	45	0.20	1.6	30	0.15	1.0
	T7325 0.4	175	0.22	2.0	135	0.20	2.0	-	-	-	-	-	55	0.20	1.6	-	-	-	
	T7335 0.4	170	0.22	2.0	130	0.20	2.0	-	-	-	-	-	55	0.20	1.6	-	-	-	
	T8330 0.4	155	0.22	2.0	90	0.20	2.0	145	0.22	2.0	465	0.26	2.0	35	0.20	1.6	30	0.15	1.0
	T8430 0.4	170	0.22	2.0	90	0.20	2.0	135	0.22	2.0	465	0.26	2.0	35	0.20	1.6	25	0.15	1.0
	T9315 0.4	245	0.20	2.0	-	-	-	230	0.20	2.0	-	-	-	-	-	-	45	0.15	1.0
	T9325 0.4	210	0.22	2.0	125	0.20	2.0	195	0.22	2.0	-	-	-	45	0.20	1.6	-	-	-
	CNMG 120408E-SM	T6310 0.8	175	0.25	2.0	125	0.23	2.0	140	0.25	2.0	525	0.30	2.0	50	0.20	1.6	35	0.15
T7325 0.8		200	0.25	2.0	155	0.23	2.0	-	-	-	-	-	65	0.20	1.6	-	-	-	
T7335 0.8		190	0.25	2.0	145	0.23	2.0	-	-	-	-	-	60	0.20	1.6	-	-	-	
T8330 0.8		175	0.25	2.0	105	0.23	2.0	165	0.25	2.0	525	0.30	2.0	40	0.20	1.6	35	0.15	1.0
T8430 0.8		195	0.25	2.0	105	0.23	2.0	160	0.25	2.0	540	0.30	2.0	40	0.20	1.6	30	0.15	1.0
T9315 0.8		265	0.25	2.0	-	-	-	250	0.25	2.0	-	-	-	-	-	-	50	0.15	1.0
T9325 0.8		235	0.25	2.0	140	0.23	2.0	220	0.25	2.0	-	-	-	50	0.20	1.6	-	-	-
CNMG 120412E-SM		T6310 1.2	175	0.30	2.0	125	0.27	2.0	140	0.30	2.0	525	0.36	2.0	50	0.24	1.6	35	0.15
	T7325 1.2	195	0.30	2.0	150	0.27	2.0	-	-	-	-	-	60	0.24	1.6	-	-	-	
	T7335 1.2	190	0.30	2.0	145	0.27	2.0	-	-	-	-	-	60	0.24	1.6	-	-	-	
	T8330 1.2	175	0.30	2.0	105	0.27	2.0	165	0.30	2.0	525	0.36	2.0	40	0.24	1.6	35	0.15	1.0
	T8430 1.2	190	0.30	2.0	105	0.27	2.0	155	0.30	2.0	525	0.36	2.0	40	0.24	1.6	30	0.15	1.0
	T9315 1.2	260	0.30	2.0	-	-	-	245	0.30	2.0	-	-	-	-	-	-	50	0.15	1.0
	T9325 1.2	235	0.30	2.0	140	0.27	2.0	220	0.30	2.0	-	-	-	50	0.24	1.6	-	-	-
	CNMG 160608E-SM	T7325 0.8	185	0.26	3.0	140	0.23	3.0	-	-	-	-	-	60	0.23	2.4	-	-	-
T7335 0.8		180	0.26	3.0	140	0.23	3.0	-	-	-	-	-	55	0.23	2.4	-	-	-	
T8330 0.8		165	0.26	3.0	95	0.23	3.0	155	0.26	3.0	495	0.31	3.0	40	0.23	2.4	30	0.15	1.0
T8430 0.8		180	0.26	3.0	95	0.23	3.0	145	0.26	3.0	495	0.31	3.0	35	0.23	2.4	30	0.15	1.0
T9325 0.8		225	0.26	3.0	135	0.23	3.0	210	0.26	3.0	-	-	-	50	0.23	2.4	-	-	-
CNMG 160612E-SM		T6310 1.2	170	0.30	3.0	120	0.27	3.0	135	0.30	3.0	510	0.36	3.0	50	0.27	2.4	30	0.15
	T7325 1.2	190	0.30	3.0	145	0.27	3.0	-	-	-	-	-	60	0.27	2.4	-	-	-	
	T7335 1.2	180	0.30	3.0	140	0.27	3.0	-	-	-	-	-	55	0.27	2.4	-	-	-	
	T9315 1.2	250	0.30	3.0	-	-	-	235	0.30	3.0	-	-	-	-	-	-	50	0.15	1.0
	T9325 1.2	225	0.30	3.0	135	0.27	3.0	210	0.30	3.0	-	-	-	50	0.27	2.4	-	-	-
	CNMG 190612E-SM	T6310 1.2	165	0.30	4.0	115	0.27	4.0	130	0.30	4.0	495	0.36	4.0	45	0.27	3.2	30	0.15
T7325 1.2		185	0.30	4.0	140	0.27	4.0	-	-	-	-	-	60	0.27	3.2	-	-	-	
T7335 1.2		175	0.30	4.0	135	0.27	4.0	-	-	-	-	-	55	0.27	3.2	-	-	-	
T9315 1.2		245	0.30	4.0	-	-	-	230	0.30	4.0	-	-	-	-	-	-	45	0.15	1.0
T9325 1.2		220	0.30	4.0	130	0.27	4.0	205	0.30	4.0	-	-	-	45	0.27	3.2	-	-	-

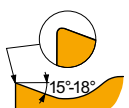

ER-SI geometria positiva destra per operazioni da finitura fino a semi sgrossatura, taglio continuo.

CNMG 120404ER-SI	T7325 0.4	220	0.20	1.7	170	0.18	1.7	-	-	-	-	-	70	0.18	1.4	-	-	-	
	T7335 0.4	215	0.20	1.7	165	0.18	1.7	-	-	-	-	-	65	0.18	1.4	-	-	-	
	T8330 0.4	195	0.20	1.7	115	0.18	1.7	-	-	-	585	0.24	1.7	45	0.18	1.4	-	-	-
	T8430 0.4	225	0.20	1.7	120	0.18	1.7	-	-	-	615	0.24	1.7	45	0.18	1.4	-	-	-
	T9325 0.4	270	0.20	1.7	160	0.18	1.7	-	-	-	-	-	60	0.18	1.4	-	-	-	
CNMG 120408ER-SI	T7325 0.8	215	0.35	1.7	165	0.32	1.7	-	-	-	-	-	65	0.25	1.4	-	-	-	
	T7335 0.8	205	0.35	1.7	155	0.32	1.7	-	-	-	-	-	65	0.25	1.4	-	-	-	
	T8315 0.8	205	0.35	1.7	120	0.32	1.7	-	-	-	615	0.42	1.7	50	0.25	1.4	-	-	-
	T8330 0.8	195	0.35	1.7	115	0.32	1.7	-	-	-	585	0.42	1.7	45	0.25	1.4	-	-	-
	T8430 0.8	210	0.35	1.7	115	0.32	1.7	-	-	-	585	0.42	1.7	45	0.25	1.4	-	-	-
	T9325 0.8	255	0.35	1.7	150	0.32	1.7	-	-	-	-	-	55	0.25	1.4	-	-	-	
CNMG 120412ER-SI	T8430 1.2	225	0.35	1.7	120	0.32	1.7	-	-	-	615	0.42	1.7	45	0.25	1.4	-	-	-



Idoneità e valori iniziali per velocità di taglio (Vc), avanzamento (f) e profondità di taglio (ap). Fare riferimento alla nostra App Machining Calculator per ulteriori calcoli.

Codice prodotto	RE (mm)	P			M			K			N			S			H		
		vc (m/min)	f (mm/rev)	ap (mm)	vc (m/min)	f (mm/rev)	ap (mm)	vc (m/min)	f (mm/rev)	ap (mm)	vc (m/min)	f (mm/rev)	ap (mm)	vc (m/min)	f (mm/rev)	ap (mm)	vc (m/min)	f (mm/rev)	ap (mm)

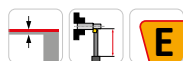
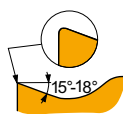

EL-SI geometria positiva sinistra per operazioni da finitura fino a semi sgrossatura, taglio continuo.

CNMG 120404EL-SI	T7325	0.4	220	0.20	1.7	170	0.18	1.7	-	-	-	-	-	70	0.18	1.4	-	-	-	
	T7335	0.4	215	0.20	1.7	165	0.18	1.7	-	-	-	-	-	65	0.18	1.4	-	-	-	
	T8330	0.4	195	0.20	1.7	115	0.18	1.7	-	-	-	585	0.24	1.7	45	0.18	1.4	-	-	-
	T8430	0.4	225	0.20	1.7	120	0.18	1.7	-	-	-	615	0.24	1.7	45	0.18	1.4	-	-	-
	T9325	0.4	270	0.20	1.7	160	0.18	1.7	-	-	-	-	-	60	0.18	1.4	-	-	-	
CNMG 120408EL-SI	T7325	0.8	215	0.35	1.7	165	0.32	1.7	-	-	-	-	-	65	0.25	1.4	-	-	-	
	T7335	0.8	205	0.35	1.7	155	0.32	1.7	-	-	-	-	-	65	0.25	1.4	-	-	-	
	T8315	0.8	205	0.35	1.7	120	0.32	1.7	-	-	-	615	0.42	1.7	50	0.25	1.4	-	-	-
	T8330	0.8	195	0.35	1.7	115	0.32	1.7	-	-	-	585	0.42	1.7	45	0.25	1.4	-	-	-
	T8430	0.8	210	0.35	1.7	115	0.32	1.7	-	-	-	585	0.42	1.7	45	0.25	1.4	-	-	-
CNMG 120412EL-SI	T8430	1.2	225	0.35	1.7	120	0.32	1.7	-	-	-	615	0.42	1.7	45	0.25	1.4	-	-	-

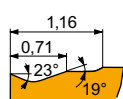

W-F geometria wiper per lavorazioni leggere e finitura con maggiore velocità di avanzamento e finitura superficiale ottimizzata.

CNMG 120408W-F	T9315	0.8	215	0.45	0.8	-	-	-	200	0.45	0.8	-	-	-	-	-	-	-	-
	T9325	0.8	190	0.45	0.8	-	-	-	180	0.45	0.8	-	-	-	-	-	-	-	-

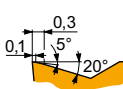

W-M geometria wiper per operazioni da semi sgrossatura fino a sgrossatura con maggiore velocità di avanzamento e finitura superficiale ottimizzata.

CNMG 120408W-M	T5315	0.8	230	0.45	1.5	-	-	-	215	0.45	1.5	-	-	-	-	-	-	-	-
	T9315	0.8	200	0.45	1.5	-	-	-	190	0.45	1.5	-	-	-	-	-	-	-	-
	T9325	0.8	185	0.45	1.5	-	-	-	175	0.45	1.5	-	-	-	-	-	-	-	-
CNMG 120412W-M	T5315	1.2	230	0.55	1.5	-	-	-	215	0.55	1.5	-	-	-	-	-	-	-	-
	T9315	1.2	200	0.55	1.5	-	-	-	190	0.55	1.5	-	-	-	-	-	-	-	-
	T9325	1.2	180	0.55	1.5	-	-	-	170	0.55	1.5	-	-	-	-	-	-	-	-

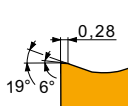

W-MR geometria wiper per operazioni da finitura fino a sgrossatura con maggiore velocità di avanzamento e finitura superficiale ottimizzata.

CNMG 120404W-MR	T9315	0.4	200	0.30	1.5	-	-	-	190	0.30	1.5	-	-	-	-	-	-	-	-
	T9325	0.4	180	0.30	1.5	105	0.27	1.5	170	0.30	1.5	-	-	-	-	-	-	-	-
CNMG 120408W-MR	T5315	0.8	230	0.45	1.5	-	-	-	215	0.45	1.5	-	-	-	-	-	-	-	-
	T9310	0.8	215	0.45	1.5	-	-	-	200	0.45	1.5	-	-	-	-	-	-	-	-
	T9315	0.8	200	0.45	1.5	-	-	-	190	0.45	1.5	-	-	-	-	-	-	-	-
CNMG 120412W-MR	T9325	0.8	185	0.45	1.5	110	0.41	1.5	175	0.45	1.5	-	-	-	-	-	-	-	-
	T5315	1.2	230	0.55	1.5	-	-	-	215	0.55	1.5	-	-	-	-	-	-	-	-
	T9310	1.2	210	0.55	1.5	-	-	-	195	0.55	1.5	-	-	-	-	-	-	-	-
CNMG 120412W-MR	T9315	1.2	200	0.55	1.5	-	-	-	190	0.55	1.5	-	-	-	-	-	-	-	-
	T9325	1.2	180	0.55	1.5	105	0.50	1.5	170	0.55	1.5	-	-	-	-	-	-	-	-

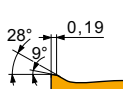

W-NM geometria wiper per operazioni da finitura fino a sgrossatura con maggiore velocità di avanzamento e finitura superficiale ottimizzata.

CNMG 120404W-NM	T7325	0.4	195	0.20	2.1	150	0.18	2.1	-	-	-	-	-	60	0.16	1.7	-	-	-
	T7335	0.4	190	0.20	2.1	145	0.18	2.1	-	-	-	-	-	60	0.16	1.7	-	-	-
	T9315	0.4	270	0.20	2.1	-	-	-	255	0.20	2.1	-	-	-	-	-	-	-	-
	T9325	0.4	240	0.20	2.1	140	0.18	2.1	225	0.20	2.1	-	-	-	50	0.16	1.7	-	-



Idoneità e valori iniziali per velocità di taglio (Vc), avanzamento (f) e profondità di taglio (ap). Fare riferimento alla nostra App Machining Calculator per ulteriori calcoli.

Codice prodotto	RE (mm)	P			M			K			N			S			H		
		vc (m/min)	f (mm/rev)	ap (mm)	vc (m/min)	f (mm/rev)	ap (mm)	vc (m/min)	f (mm/rev)	ap (mm)	vc (m/min)	f (mm/rev)	ap (mm)	vc (m/min)	f (mm/rev)	ap (mm)	vc (m/min)	f (mm/rev)	ap (mm)

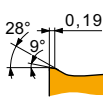

W-NM geometria wiper per operazioni da finitura fino a sgrossatura con maggiore velocità di avanzamento e finitura superficiale ottimizzata.

CNMG 120408W-NM	T7325	0.8	215	0.25	2.1	165	0.23	2.1	—	—	—	—	—	—	65	0.20	1.7	—	—	—
	T7335	0.8	210	0.25	2.1	160	0.23	2.1	—	—	—	—	—	—	65	0.20	1.7	—	—	—
	T9315	0.8	290	0.25	2.1	—	—	—	275	0.25	2.1	—	—	—	—	—	—	—	—	—
	T9325	0.8	260	0.25	2.1	155	0.23	2.1	245	0.25	2.1	—	—	—	55	0.20	1.7	—	—	—
CNMG 120412W-NM	T7325	1.2	215	0.30	2.1	165	0.27	2.1	—	—	—	—	—	—	65	0.24	1.7	—	—	—
	T7335	1.2	210	0.30	2.1	160	0.27	2.1	—	—	—	—	—	—	65	0.24	1.7	—	—	—
	T9315	1.2	285	0.30	2.1	—	—	—	270	0.30	2.1	—	—	—	—	—	—	—	—	—
	T9325	1.2	255	0.30	2.1	150	0.27	2.1	240	0.30	2.1	—	—	—	55	0.24	1.7	—	—	—

CNMM



	IC (mm)	D1 (mm)	L (mm)	S (mm)
1204	12.700	5.16	12.90	4.76
1606	15.875	6.35	16.10	6.35
1906	19.050	7.94	19.30	6.35
2509	25.400	9.12	25.80	9.53

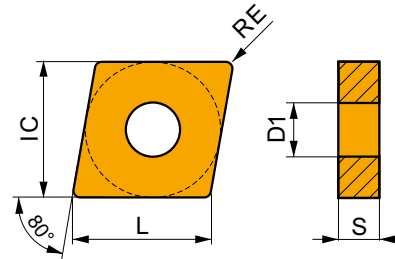

Idoneità e valori iniziali per velocità di taglio (Vc), avanzamento (f) e profondità di taglio (ap). Fare riferimento alla nostra App Machining Calculator per ulteriori calcoli.

Codice prodotto	RE (mm)	P			M			K			N			S			H		
		vc (m/min)	f (mm/rev)	ap (mm)	vc (m/min)	f (mm/rev)	ap (mm)	vc (m/min)	f (mm/rev)	ap (mm)	vc (m/min)	f (mm/rev)	ap (mm)	vc (m/min)	f (mm/rev)	ap (mm)	vc (m/min)	f (mm/rev)	ap (mm)

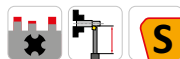
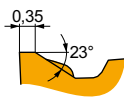

DR geometria per operazioni da semi sgrossatura fino a sgrossatura, da taglio continuo a interrotto.

CNMM 160612E-DR	T9315	1.2	225	0.45	6.0	—	—	—	210	0.45	6.0	—	—	—	—	—	—	—	—
	T9325	1.2	200	0.45	6.0	120	0.41	6.0	190	0.45	6.0	—	—	—	—	—	—	—	
	T9335	1.2	170	0.45	6.0	100	0.41	6.0	—	—	—	—	—	—	—	—	—	—	
CNMM 190608E-DR	T9315	0.8	215	0.40	8.0	—	—	—	200	0.40	8.0	—	—	—	—	—	—	—	
	T9325	0.8	190	0.40	8.0	110	0.36	8.0	180	0.40	8.0	—	—	—	—	—	—	—	
CNMM 190612E-DR	T9315	1.2	220	0.45	8.0	—	—	—	205	0.45	8.0	—	—	—	—	—	—	—	
	T9325	1.2	195	0.45	8.0	115	0.41	8.0	185	0.45	8.0	—	—	—	—	—	—	—	
	T9335	1.2	170	0.45	8.0	100	0.41	8.0	—	—	—	—	—	—	—	—	—	—	
CNMM 190616E-DR	T9325	1.6	195	0.50	9.0	115	0.45	9.0	185	0.50	9.0	—	—	—	—	—	—	—	
	T9335	1.6	170	0.50	9.0	100	0.45	9.0	—	—	—	—	—	—	—	—	—	—	

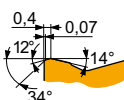

HR geometria per operazioni da sgrossatura fino a sgrossatura pesante, taglio continuo e interrotto.

CNMM 190616E-HR	6640	1.6	75	0.60	10.0	45	0.54	10.0	70	0.60	10.0	—	—	—	—	—	—	—
	T8345	1.6	55	0.60	10.0	30	0.54	10.0	50	0.60	10.0	—	—	—	—	—	—	—
	T9325	1.6	105	0.60	10.0	60	0.54	10.0	95	0.60	10.0	—	—	—	—	—	—	—
	T9335	1.6	80	0.60	10.0	45	0.54	10.0	—	—	—	—	—	—	—	—	—	—
CNMM 190624E-HR	T8345	2.4	60	0.65	10.0	35	0.59	10.0	55	0.65	10.0	—	—	—	—	—	—	—
	T9315	2.4	115	0.65	10.0	—	—	—	105	0.65	10.0	—	—	—	—	—	—	—
	T9325	2.4	100	0.65	10.0	60	0.59	10.0	95	0.65	10.0	—	—	—	—	—	—	—
	T9335	2.4	85	0.65	10.0	50	0.59	10.0	—	—	—	—	—	—	—	—	—	—



Idoneità e valori iniziali per velocità di taglio (Vc), avanzamento (f) e profondità di taglio (ap). Fare riferimento alla nostra App Machining Calculator per ulteriori calcoli.

Codice prodotto	RE  (mm)	P			M			K			N			S			H		
		vc (m/min)	f (mm/rev)	ap (mm)	vc (m/min)	f (mm/rev)	ap (mm)	vc (m/min)	f (mm/rev)	ap (mm)	vc (m/min)	f (mm/rev)	ap (mm)	vc (m/min)	f (mm/rev)	ap (mm)	vc (m/min)	f (mm/rev)	ap (mm)

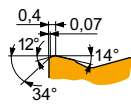

HR geometria per operazioni da sgrossatura fino a sgrossatura pesante, taglio continuo e interrotto.

CNMM 250924E-HR	6640	2.4	■	75	0.65	14.0	▣	45	0.59	14.0	■	70	0.65	14.0	■	–	–	–	–	–	–
	T8345	2.4	■	55	0.65	14.0	▣	30	0.59	14.0	■	50	0.65	14.0	■	–	–	–	–	–	–
	T9315	2.4	■	110	0.65	14.0	■	–	–	–	■	100	0.65	14.0	■	–	–	–	–	–	–
	T9325	2.4	■	100	0.65	14.0	▣	60	0.59	14.0	■	95	0.65	14.0	■	–	–	–	–	–	–
	T9335	2.4	■	80	0.65	14.0	▣	45	0.59	14.0	■	–	–	–	■	–	–	–	–	–	–

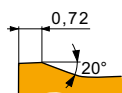

HR2 geometria per operazioni da sgrossatura fino a sgrossatura pesante, taglio continuo e interrotto.

CNMM 190616-HR2	T9226	1.6	■	85	0.65	10.0	▣	50	0.59	10.0	■	80	0.65	10.0	■	–	–	–	–	–	–
	T9315	1.6	■	110	0.65	10.0	■	–	–	–	■	100	0.65	10.0	■	–	–	–	–	–	–
	T9335	1.6	■	80	0.65	10.0	▣	45	0.59	10.0	■	–	–	–	■	–	–	–	–	–	–
CNMM 190624-HR2	T9226	2.4	■	80	0.85	10.0	▣	45	0.77	10.0	■	75	0.85	10.0	■	–	–	–	–	–	–
	T9315	2.4	■	100	0.85	10.0	■	–	–	–	■	95	0.85	10.0	■	–	–	–	–	–	–
	T9335	2.4	■	75	0.85	10.0	▣	45	0.77	10.0	■	–	–	–	■	–	–	–	–	–	–
CNMM 250924-HR2	T9315	2.4	■	100	0.85	12.0	■	–	–	–	■	95	0.85	12.0	■	–	–	–	–	–	–
	T9335	2.4	■	75	0.85	12.0	▣	45	0.77	12.0	■	–	–	–	■	–	–	–	–	–	–

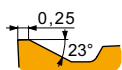

NR geometria per operazioni da semi sgrossatura fino a sgrossatura, da taglio continuo a interrotto.

CNMM 120408E-NR	6640	0.8	■	155	0.40	3.0	▣	90	0.36	3.0	■	145	0.40	3.0	■	–	–	–	–	–	–
	T7325	0.8	▣	175	0.40	3.0	■	135	0.36	3.0	■	–	–	–	■	55	0.28	2.4	–	–	–
	T7335	0.8	▣	165	0.40	3.0	■	125	0.36	3.0	■	–	–	–	■	50	0.28	2.4	–	–	–
	T8330	0.8	■	155	0.40	3.0	■	90	0.36	3.0	■	145	0.40	3.0	■	35	0.28	2.4	–	–	–
	T8430	0.8	■	165	0.40	3.0	■	90	0.36	3.0	■	135	0.40	3.0	■	35	0.28	2.4	–	–	–
	T9315	0.8	■	215	0.40	3.0	■	–	–	–	■	200	0.40	3.0	■	–	–	–	–	–	–
	T9325	0.8	■	195	0.40	3.0	■	115	0.36	3.0	■	185	0.40	3.0	■	40	0.28	2.4	–	–	–
CNMM 120412E-NR	T7325	1.2	▣	185	0.40	3.0	■	140	0.36	3.0	■	–	–	–	■	60	0.28	2.4	–	–	–
	T7335	1.2	▣	175	0.40	3.0	■	135	0.36	3.0	■	–	–	–	■	55	0.28	2.4	–	–	–
	T8330	1.2	■	165	0.40	3.0	■	95	0.36	3.0	■	155	0.40	3.0	■	40	0.28	2.4	–	–	–
	T8430	1.2	■	170	0.40	3.0	■	90	0.36	3.0	■	135	0.40	3.0	■	35	0.28	2.4	–	–	–
	T9325	1.2	■	205	0.40	3.0	■	120	0.36	3.0	■	190	0.40	3.0	■	45	0.28	2.4	–	–	–

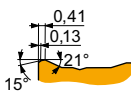

NR2 geometria per operazioni da semi sgrossatura fino a sgrossatura, da taglio continuo a interrotto.

CNMM 120408E-NR2	T7325	0.8	▣	165	0.40	5.0	■	125	0.36	5.0	■	–	–	–	■	50	0.28	4.0	–	–	–
	T7335	0.8	▣	155	0.40	5.0	■	120	0.36	5.0	■	–	–	–	■	50	0.28	4.0	–	–	–
	T8330	0.8	■	150	0.40	5.0	■	90	0.36	5.0	■	140	0.40	5.0	■	35	0.28	4.0	–	–	–
	T8430	0.8	■	150	0.40	5.0	■	80	0.36	5.0	■	125	0.40	5.0	■	30	0.28	4.0	–	–	–
	T9315	0.8	■	205	0.40	5.0	■	–	–	–	■	190	0.40	5.0	■	–	–	–	–	–	–
CNMM 120412E-NR2	T9325	0.8	■	185	0.40	5.0	■	110	0.36	5.0	■	175	0.40	5.0	■	40	0.28	4.0	–	–	–
	T7335	1.2	▣	155	0.45	5.0	■	120	0.41	5.0	■	–	–	–	■	50	0.32	4.0	–	–	–
	T8330	1.2	■	150	0.45	5.0	■	90	0.41	5.0	■	140	0.45	5.0	■	35	0.32	4.0	–	–	–
	T8430	1.2	■	150	0.45	5.0	■	80	0.41	5.0	■	125	0.45	5.0	■	30	0.32	4.0	–	–	–
	T9315	1.2	■	205	0.45	5.0	■	–	–	–	■	190	0.45	5.0	■	–	–	–	–	–	–
CNMM 160608E-NR2	T9325	1.2	■	185	0.45	5.0	■	110	0.41	5.0	■	175	0.45	5.0	■	40	0.32	4.0	–	–	–
	T8330	0.8	■	145	0.40	6.0	■	85	0.36	6.0	■	135	0.40	6.0	■	35	0.32	4.8	–	–	–
	T8430	0.8	■	150	0.40	6.0	■	80	0.36	6.0	■	125	0.40	6.0	■	30	0.32	4.8	–	–	–
T9325	0.8	■	180	0.40	6.0	■	105	0.36	6.0	■	170	0.40	6.0	■	40	0.32	4.8	–	–	–	



Idoneità e valori iniziali per velocità di taglio (V_c), avanzamento (f) e profondità di taglio (a_p). Fare riferimento alla nostra App Machining Calculator per ulteriori calcoli.

Codice prodotto	RE  (mm)	P			M			K			N			S			H		
		v_c (m/min)	f (mm/rev)	a_p (mm)	v_c (m/min)	f (mm/rev)	a_p (mm)	v_c (m/min)	f (mm/rev)	a_p (mm)	v_c (m/min)	f (mm/rev)	a_p (mm)	v_c (m/min)	f (mm/rev)	a_p (mm)	v_c (m/min)	f (mm/rev)	a_p (mm)

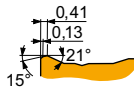

NR2 geometria per operazioni da semi sgrossatura fino a sgrossatura, da taglio continuo a interrotto.

CNMM 160612E-NR2	T7325	1.2	✓	165	0.45	6.0	■	125	0.41	6.0	—	—	—	✓	50	0.36	4.8	—	—	—	
	T7335	1.2	✓	155	0.45	6.0	■	120	0.41	6.0	—	—	—	✓	50	0.36	4.8	—	—	—	
	T8330	1.2	■	145	0.45	6.0	■	85	0.41	6.0	✓	135	0.45	6.0	—	—	—	✓	35	0.36	4.8
	T8430	1.2	■	150	0.45	6.0	■	80	0.41	6.0	✓	125	0.45	6.0	—	—	—	✓	30	0.36	4.8
	T9315	1.2	■	205	0.45	6.0	■	—	—	—	✓	190	0.45	6.0	—	—	—	—	—	—	—
	T9325	1.2	■	185	0.45	6.0	■	110	0.41	6.0	✓	175	0.45	6.0	—	—	—	✓	40	0.36	4.8
CNMM 160616E-NR2	T7325	1.6	✓	165	0.50	6.0	■	125	0.45	6.0	—	—	—	✓	50	0.40	4.8	—	—	—	
	T7335	1.6	✓	160	0.50	6.0	■	120	0.45	6.0	—	—	—	✓	50	0.40	4.8	—	—	—	
	T9325	1.6	■	180	0.50	6.0	■	105	0.45	6.0	✓	170	0.50	6.0	—	—	—	✓	40	0.40	4.8
CNMM 190612E-NR2	T7325	1.2	✓	155	0.45	9.0	■	120	0.41	9.0	—	—	—	✓	50	0.36	7.2	—	—	—	
	T7335	1.2	✓	145	0.45	9.0	■	110	0.41	9.0	—	—	—	✓	45	0.36	7.2	—	—	—	
	T8330	1.2	■	140	0.45	9.0	■	80	0.41	9.0	✓	130	0.45	9.0	—	—	—	✓	35	0.36	7.2
	T8430	1.2	■	140	0.45	9.0	■	75	0.41	9.0	✓	115	0.45	9.0	—	—	—	✓	30	0.36	7.2
	T9325	1.2	■	175	0.45	9.0	■	105	0.41	9.0	✓	165	0.45	9.0	—	—	—	✓	35	0.36	7.2
CNMM 190616E-NR2	T7325	1.6	✓	160	0.50	9.0	■	120	0.45	9.0	—	—	—	✓	50	0.40	7.2	—	—	—	
	T7335	1.6	✓	150	0.50	9.0	■	115	0.45	9.0	—	—	—	✓	45	0.40	7.2	—	—	—	
	T8330	1.6	■	140	0.50	9.0	■	80	0.45	9.0	✓	130	0.50	9.0	—	—	—	✓	35	0.40	7.2
	T8430	1.6	■	140	0.50	9.0	■	75	0.45	9.0	✓	115	0.50	9.0	—	—	—	✓	30	0.40	7.2
	T9315	1.6	■	195	0.50	9.0	■	—	—	—	✓	185	0.50	9.0	—	—	—	—	—	—	—
	T9325	1.6	■	175	0.50	9.0	■	105	0.45	9.0	✓	165	0.50	9.0	—	—	—	✓	35	0.40	7.2
CNMM 190624E-NR2	T7335	2.4	✓	130	0.80	9.0	■	100	0.72	9.0	—	—	—	✓	40	0.56	7.2	—	—	—	
	T9325	2.4	■	150	0.80	9.0	■	90	0.72	9.0	✓	140	0.80	9.0	—	—	—	✓	30	0.56	7.2
CNMM 250924E-NR2	T7325	2.4	✓	100	0.80	12.0	■	75	0.72	12.0	—	—	—	✓	30	0.56	9.6	—	—	—	
	T7335	2.4	✓	95	0.80	12.0	■	70	0.72	12.0	—	—	—	✓	30	0.56	9.6	—	—	—	
	T8430	2.4	■	80	0.80	12.0	■	45	0.72	12.0	✓	65	0.80	12.0	—	—	—	✓	15	0.56	9.6
	T9315	2.4	■	110	0.80	12.0	■	—	—	—	✓	100	0.80	12.0	—	—	—	—	—	—	—
	T9325	2.4	■	100	0.80	12.0	■	60	0.72	12.0	✓	95	0.80	12.0	—	—	—	✓	20	0.56	9.6

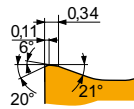

NRM geometria con design positivo per operazioni da semi sgrossatura fino a sgrossatura, da taglio continuo a moderatamente interrotto.

CNMM 250924-NRM	T7325	2.4	✓	95	0.70	10.0	■	70	0.63	10.0	—	—	—	■	30	0.49	8.0	—	—	—
	T7335	2.4	✓	90	0.70	10.0	■	70	0.63	10.0	—	—	—	■	25	0.49	8.0	—	—	—
	T9315	2.4	■	115	0.70	10.0	■	—	—	—	✓	105	0.70	10.0	—	—	—	—	—	—

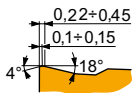
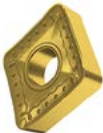

OR geometria per operazioni da semi sgrossatura fino a sgrossatura, da taglio continuo a interrotto.

CNMM 120408E-OR	T8330	0.8	■	150	0.40	5.0	✓	90	0.36	5.0	■	140	0.40	5.0	—	—	—	✓	35	0.28	4.0
	T8430	0.8	■	150	0.40	5.0	✓	80	0.36	5.0	✓	125	0.40	5.0	—	—	—	✓	30	0.28	4.0
	T9315	0.8	■	205	0.40	5.0	■	—	—	—	✓	190	0.40	5.0	—	—	—	—	—	—	—
	T9325	0.8	■	185	0.40	5.0	✓	110	0.36	5.0	✓	175	0.40	5.0	—	—	—	✓	40	0.28	4.0
	T9335	0.8	■	160	0.40	5.0	✓	95	0.36	5.0	—	—	—	✓	35	0.28	4.0	—	—	—	
CNMM 120412E-OR	T9315	1.2	■	205	0.45	5.0	■	—	—	—	✓	190	0.45	5.0	—	—	—	—	—	—	—
	T9325	1.2	■	185	0.45	5.0	✓	110	0.41	5.0	✓	175	0.45	5.0	—	—	—	✓	40	0.36	4.0
	T9335	1.2	■	165	0.45	5.0	✓	95	0.41	5.0	—	—	—	✓	35	0.36	4.0	—	—	—	
CNMM 120416E-OR	T9325	1.6	■	190	0.50	5.0	✓	110	0.45	5.0	✓	180	0.50	5.0	—	—	—	✓	40	0.40	4.0
	T9335	1.6	■	165	0.50	5.0	✓	95	0.45	5.0	—	—	—	✓	35	0.40	4.0	—	—	—	
CNMM 160608E-OR	T9315	0.8	■	205	0.40	6.0	■	—	—	—	✓	190	0.40	6.0	—	—	—	—	—	—	—
	T9325	0.8	■	180	0.40	6.0	✓	105	0.36	6.0	✓	170	0.40	6.0	—	—	—	✓	40	0.32	4.8
	T9335	0.8	■	160	0.40	6.0	✓	95	0.36	6.0	—	—	—	✓	35	0.32	4.8	—	—	—	
CNMM 160612E-OR	T8430	1.2	■	150	0.45	6.0	✓	80	0.41	6.0	✓	125	0.45	6.0	—	—	—	✓	30	0.36	4.8
	T9315	1.2	■	205	0.45	6.0	■	—	—	—	✓	190	0.45	6.0	—	—	—	—	—	—	—
	T9325	1.2	■	185	0.45	6.0	✓	110	0.41	6.0	✓	175	0.45	6.0	—	—	—	✓	40	0.36	4.8



Idoneità e valori iniziali per velocità di taglio (Vc), avanzamento (f) e profondità di taglio (ap). Fare riferimento alla nostra App Machining Calculator per ulteriori calcoli.

Codice prodotto	RE  (mm)	P			M			K			N			S			H		
		vc (m/min)	f (mm/rev)	ap (mm)	vc (m/min)	f (mm/rev)	ap (mm)	vc (m/min)	f (mm/rev)	ap (mm)	vc (m/min)	f (mm/rev)	ap (mm)	vc (m/min)	f (mm/rev)	ap (mm)	vc (m/min)	f (mm/rev)	ap (mm)

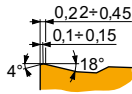

OR geometria per operazioni da semi sgrossatura fino a sgrossatura, da taglio continuo a interrotto.

CNMM 160616E-OR	T9315	1.6	205	0.50	6.0	–	–	–	190	0.50	6.0	–	–	–	–	–	–	–	–
	T9325	1.6	180	0.50	6.0	105	0.45	6.0	170	0.50	6.0	–	–	–	40	0.40	4.8	–	–
CNMM 190612E-OR	T8330	1.2	140	0.45	9.0	80	0.41	9.0	130	0.45	9.0	–	–	–	35	0.36	7.2	–	–
	T8430	1.2	140	0.45	9.0	75	0.41	9.0	115	0.45	9.0	–	–	–	30	0.36	7.2	–	–
	T9315	1.2	195	0.45	9.0	–	–	–	185	0.45	9.0	–	–	–	–	–	–	–	–
CNMM 190616E-OR	T9325	1.2	175	0.45	9.0	105	0.41	9.0	165	0.45	9.0	–	–	–	35	0.36	7.2	–	–
	T9335	1.2	150	0.45	9.0	90	0.41	9.0	–	–	–	–	–	–	30	0.36	7.2	–	–
	T8330	1.6	140	0.50	9.0	80	0.45	9.0	130	0.50	9.0	–	–	–	35	0.40	7.2	–	–
	T8345	1.6	120	0.50	9.0	70	0.45	9.0	110	0.50	9.0	–	–	–	30	0.40	7.2	–	–
	T8430	1.6	140	0.50	9.0	75	0.45	9.0	115	0.50	9.0	–	–	–	30	0.40	7.2	–	–
CNMM 190624E-OR	T9315	1.6	195	0.50	9.0	–	–	–	185	0.50	9.0	–	–	–	–	–	–	–	–
	T9325	1.6	175	0.50	9.0	105	0.45	9.0	165	0.50	9.0	–	–	–	35	0.40	7.2	–	–
	T9335	1.6	155	0.50	9.0	90	0.45	9.0	–	–	–	–	–	–	30	0.40	7.2	–	–
	T9315	2.4	165	0.80	9.0	–	–	–	155	0.80	9.0	–	–	–	–	–	–	–	–
CNMM 250924E-OR	T9325	2.4	150	0.80	9.0	90	0.72	9.0	140	0.80	9.0	–	–	–	30	0.56	7.2	–	–
	T8330	2.4	75	1.00	12.0	45	0.90	12.0	70	1.00	12.0	–	–	–	15	0.70	9.6	–	–
	T8430	2.4	75	1.00	12.0	40	0.90	12.0	60	1.00	12.0	–	–	–	15	0.70	9.6	–	–
	T9315	2.4	100	1.00	12.0	–	–	–	95	1.00	12.0	–	–	–	–	–	–	–	–
	T9325	2.4	95	1.00	12.0	55	0.90	12.0	90	1.00	12.0	–	–	–	20	0.70	9.6	–	–
	T9335	2.4	75	1.00	12.0	45	0.90	12.0	–	–	–	–	–	–	15	0.70	9.6	–	–

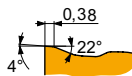

OR1 geometria per operazioni da semi sgrossatura fino a sgrossatura pesante, da taglio continuo a interrotto.

CNMM 190616E-OR1	T9325	1.6	175	0.50	9.0	105	0.45	9.0	165	0.50	9.0	–	–	–	35	0.35	7.2	–	–
	T9335	1.6	155	0.50	9.0	90	0.45	9.0	–	–	–	–	–	–	30	0.35	7.2	–	–

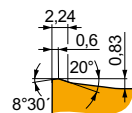

923 geometria per operazioni da semi sgrossatura fino a sgrossatura pesante, da taglio continuo a fortemente interrotto.

CNMM 250924S-923	T8330	2.4	75	0.85	12.0	45	0.77	12.0	70	0.85	12.0	–	–	–	15	0.60	9.6	–	–
	T8430	2.4	75	0.85	12.0	40	0.77	12.0	60	0.85	12.0	–	–	–	15	0.60	9.6	–	–
	T9335	2.4	75	0.85	12.0	45	0.77	12.0	–	–	–	–	–	–	15	0.60	9.6	–	–



CNGA CER

	IC	D1	L	S
	(mm)	(mm)	(mm)	(mm)
1204	12.700	5.16	12.90	4.76

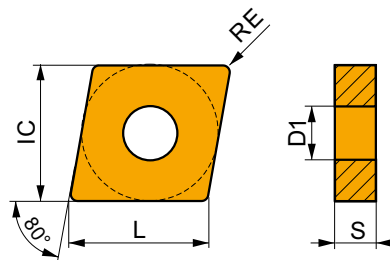

Idoneità e valori iniziali per velocità di taglio (Vc), avanzamento (f) e profondità di taglio (ap). Fare riferimento alla nostra App Machining Calculator per ulteriori calcoli.

Codice prodotto	RE	P			M			K			N			S			H		
		vc	f	ap	vc	f	ap	vc	f	ap	vc	f	ap	vc	f	ap	vc	f	ap
	(mm)	(m/min)	(mm/rev)	(mm)	(m/min)	(mm/rev)	(mm)	(m/min)	(mm/rev)	(mm)	(m/min)	(mm/rev)	(mm)	(m/min)	(mm/rev)	(mm)	(m/min)	(mm/rev)	(mm)

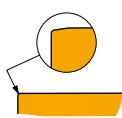
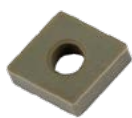

Adatta per lavorazioni con elevata velocità e taglio continuo.

CNGA 120404 T02020	TC100	0.4	-	-	-	-	-	-	590	0.10	2.0	-	-	-	-	-	-	-	-
CNGA 120408 T01020	TC100	0.8	-	-	-	-	-	-	550	0.20	2.0	-	-	-	-	-	-	-	-
CNGA 120412 T01020	TC100	1.2	-	-	-	-	-	-	540	0.25	2.0	-	-	-	-	-	-	-	-

CNGN CER

	IC	L	S
	(mm)	(mm)	(mm)
1204	12.700	12.90	4.76
1207	12.700	12.90	7.94

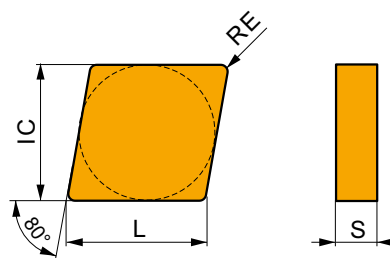

Idoneità e valori iniziali per velocità di taglio (Vc), avanzamento (f) e profondità di taglio (ap). Fare riferimento alla nostra App Machining Calculator per ulteriori calcoli.

Codice prodotto	RE	P			M			K			N			S			H		
		vc	f	ap	vc	f	ap	vc	f	ap	vc	f	ap	vc	f	ap	vc	f	ap
	(mm)	(m/min)	(mm/rev)	(mm)	(m/min)	(mm/rev)	(mm)	(m/min)	(mm/rev)	(mm)	(m/min)	(mm/rev)	(mm)	(m/min)	(mm/rev)	(mm)	(m/min)	(mm/rev)	(mm)

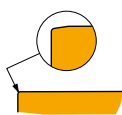
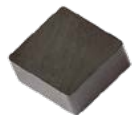

Adatta per lavorazioni con elevata velocità e taglio continuo.

CNGN 120408 T01020	TC100	0.8	-	-	-	-	-	-	550	0.20	2.0	-	-	-	-	-	-	-	-
CNGN 120708 T01020	TC100	0.8	-	-	-	-	-	-	550	0.20	2.0	-	-	-	-	-	-	-	-
CNGN 120712 T01020	TC100	1.2	-	-	-	-	-	-	540	0.25	2.0	-	-	-	-	-	-	-	-



CNGA CBN

	IC	D1	L	S
	(mm)	(mm)	(mm)	(mm)
1204	12.700	5.16	12.90	4.76

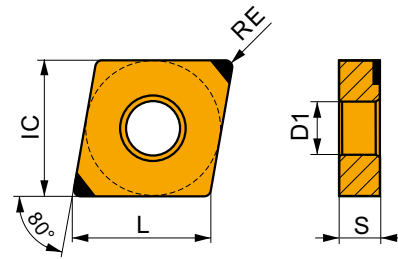

Idoneità e valori iniziali per velocità di taglio (V_c), avanzamento (f) e profondità di taglio (a_p). Fare riferimento alla nostra App Machining Calculator per ulteriori calcoli.

Codice prodotto	RE	P			M			K			N			S			H		
		v_c (m/min)	f (mm/rev)	a_p (mm)	v_c (m/min)	f (mm/rev)	a_p (mm)	v_c (m/min)	f (mm/rev)	a_p (mm)	v_c (m/min)	f (mm/rev)	a_p (mm)	v_c (m/min)	f (mm/rev)	a_p (mm)	v_c (m/min)	f (mm/rev)	a_p (mm)

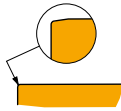

Adatta per operazioni di finitura e taglio continuo.

CNGA 120404S01020B	TB310	0.4								510	0.10	0.4				135	0.07	0.3	105	0.15	1.0
CNGA 120408S01020B	TB310	0.8								530	0.15	0.6				140	0.11	0.5	110	0.15	1.0



DCBN(RL) EXT



PRAMET

D



Utensile esterno, doppio bloccaggio, angolo del tagliente utensile 75°, inserti CN..

Utensile esterno di tornitura destro / sinistro, doppio bloccaggio a staffa, angolo del tagliente dell'utensile 75°. Adatto per tornitura longitudinale e sfaccitura senza spallamento e smussi con inserto CN.. negativo dimensioni da 12 a 19. Disponibile con steli da 20x20 a 40x40 mm. Corpo trattato per una maggiore durata dell'utensile.

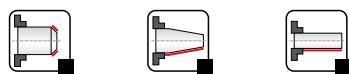
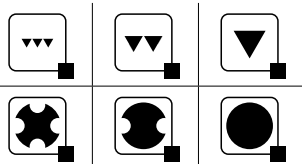
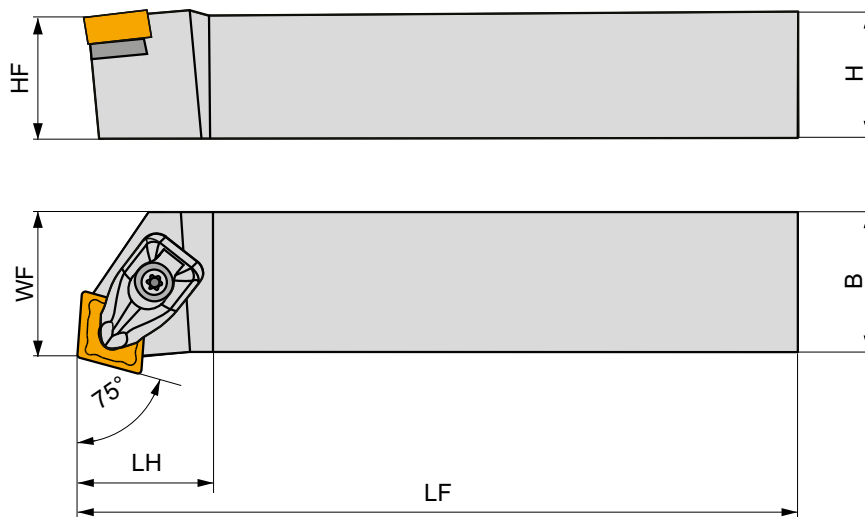

Codice prodotto	H	B	H _F	WF	LF	LH	LAMS	GAMO	kg			
	(mm)	(mm)	(mm)	(mm)	(mm)	(mm)	(°)	(°)				
R DCBNR 2020 K 12	20	20	20	17	125	34.2	-6	-6	0.43	GI043	DC12	AT001
DCBNR 2525 M 12	25	25	25	22	150	34.6	-6	-6	0.76	GI043	DC12	AT001
DCBNR 3225 P 12	32	25	32	22	170	34.6	-6	-6	1.09	GI043	DC12	AT001
DCBNR 2525 M 16	25	25	25	22	150	41.5	-6	-6	0.80	GI050	DC16	AT005
DCBNR 3225 P 16	32	25	32	22	170	32	-6	-6	1.11	GI050	DC16	AT005
DCBNR 3232 P 19	32	32	32	27	170	46.1	-6	-6	1.39	GI042	DC19	-
DCBNR 4040 S 19	40	40	40	35	250	46.7	-6	-6	3.16	GI042	DC19	-
L DCBNL 2020 K 12	20	20	20	17	125	34.2	-6	-6	0.43	GI043	DC12	AT001
DCBNL 2525 M 12	25	25	25	22	150	34.6	-6	-6	0.76	GI043	DC12	AT001
DCBNL 3225 P 12	32	25	32	22	170	34.6	-6	-6	1.09	GI043	DC12	AT001
DCBNL 2525 M 16	25	25	25	22	150	41.5	-6	-6	0.79	GI050	DC16	AT005
DCBNL 3225 P 16	32	25	32	22	170	32	-6	-6	1.11	GI050	DC16	AT005
DCBNL 3232 P 19	32	32	32	27	170	46.1	-6	-6	1.39	GI042	DC19	-







GI042
GI043
GI050

CN.. 1906..
CN.. 1204..
CN.. 1606..



DC12	DCS 12	3.9	DCS 234-01	US 2002-T15P	FLAG T15P/3,5	-
DC16	DCS 16	6.4	DCS 234-03	US 2007-T20P	-	LK T20P
DC19	DCS 19	6.4	DCS 236-01	US 2007-T20P	-	LK T20P



			
AT001a	CN.. 1207..	–	DCS 234-02
AT005a	CN.. 1607..	–	DCS 234-04
AT001b	CER CN.N 1204..	DCS 12C4	–
AT001c	CER CN.A 1204..	DCS 12C2	–
AT005b	CER CN.N 1606..	DCS 16C4	–
AT005c	CER CN.A 1606..	DCS 16C2	–



DCKN(RL) EXT



Utensile esterno, doppio bloccaggio, angolo del tagliente utensile 75° (sfacciare), inserti CN..

Utensile esterno di tornitura con doppio bloccaggio a staffa, destro / sinistro, angolo del tagliente utensile 75°. Adatto per tornitura di sfacciatura ed occasionalmente smussatura con inserti CN negativi .. 12 o 16. Disponibile con gambo da 20x20 a 32x32 mm. Corpo trattato per una maggiore durata dell'utensile.

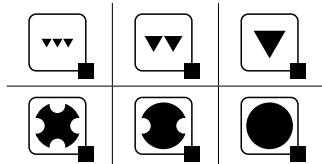
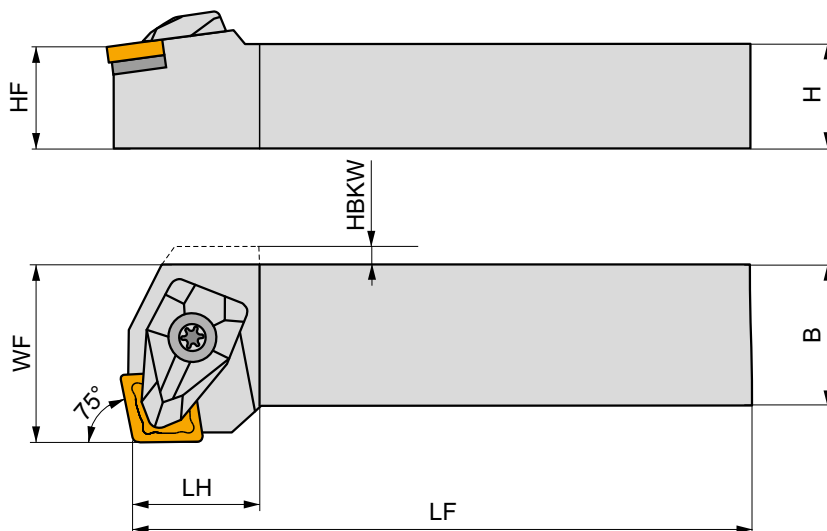
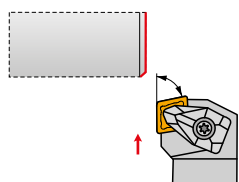

Codice prodotto	H	B	HF	WF	LF	LH	HBKW	LAMS	GAMO	kg			
	(mm)	(mm)	(mm)	(mm)	(mm)	(mm)	(mm)	(°)	(°)				
R DCKNR 2020 K 12	20	20	20	25	125	21.2	4.5	-6	-6	0.46	G1043	DC12	AT001
DCKNR 2525 M 12	25	25	25	32	150	21.1	-	-6	-6	0.80	G1043	DC12	AT001
DCKNR 3225 P 12	32	25	32	32	170	21.1	-	-6	-6	1.14	G1043	DC12	AT001
DCKNR 3232 P 16	32	32	32	40	170	26	-	-6	-6	1.46	G1050	DC16	AT005
L DCKNL 2020 K 12	20	20	20	25	125	21.2	4.5	-6	-6	0.46	G1043	DC12	AT001
DCKNL 2525 M 12	25	25	25	32	150	21.1	-	-6	-6	0.80	G1043	DC12	AT001
DCKNL 3225 P 12	32	25	32	32	170	21.1	-	-6	-6	1.13	G1043	DC12	AT001
DCKNL 3232 P 16	32	32	32	40	170	26	-	-6	-6	1.46	G1050	DC16	AT005



G1043

G1050



CN.. 1204..

CN.. 1606..



DC12

DC16



DCS 12

DCS 16



3.9

6.4



DCS 234-01

DCS 234-03



US 2002-T15P

US 2007-T20P



FLAG T15P/3,5

-



-

LK T20P



AT001a

AT005a

AT001b

AT001c

AT005b

AT005c



CN.. 1207..

CN.. 1607..

CER CN.N 1204..

CER CN.A 1204..

CER CN.N 1606..

CER CN.A 1606..



-

-

DCS 12C4

DCS 12C2

DCS 16C4

DCS 16C2



DCS 234-02

DCS 234-04

-

-

-

-



DCLN(RL) EXT



PRAMET

D

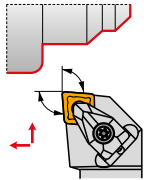

Utensile esterno, doppio bloccaggio, angolo del tagliente utensile 95°, inserti CN..

Utensile esterno di tornitura destro / sinistro, doppio bloccaggio a staffa, angolo del tagliente dell'utensile 95°. Adatto per tornitura longitudinale, smussatura e sfacciatura con spallamento, inserti CN.. negativi, dimensioni da 09 fino a 19 e disponibile con steli da 16x16 a 40x40 mm. Corpo trattato per una maggiore durata dell'utensile.

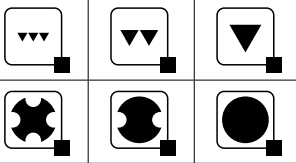
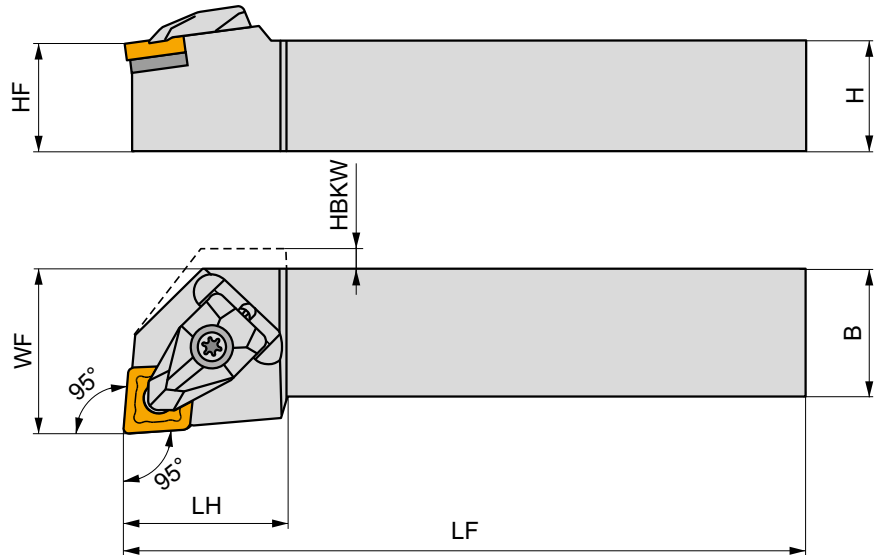

Codice prodotto	H	B	HF	WF	LF	LH	HBKW	LAMS	GAMO	kg			
	(mm)	(mm)	(mm)	(mm)	(mm)	(mm)	(mm)	(°)	(°)				
R	DCLNR 1616 H 09	16	16	16	20	100	25	-	-6	0.27	G1042	DC09	AT001
	DCLNR 2020 K 09	20	20	20	25	125	25	-	-6	0.44	G1042	DC09	AT001
	DCLNR 2525 M 09	25	25	25	32	150	25	-	-6	0.78	G1042	DC09	AT001
	DCLNR 1616 H 12	16	16	16	20	100	32.3	4.5	-6	0.26	G1043	DC12	AT001
	DCLNR 2020 K 12	20	20	20	25	125	30	-	-6	0.44	G1043	DC12	AT001
	DCLNR 2525 M 12	25	25	25	32	150	30	-	-6	0.78	G1043	DC12	AT001
	DCLNR 3225 P 12	32	25	32	32	170	30	-	-6	1.10	G1043	DC12	AT001
	DCLNR 2525 M 16	25	25	25	32	150	39	-	-6	0.81	G1050	DC16	AT005
	DCLNR 3225 P 16	32	25	32	32	170	35	-	-6	1.20	G1050	DC16	AT005
	DCLNR 3232 P 19	32	32	32	40	170	40	-	-6	1.55	G1042	DC19	AT001
DCLNR 4040 S 19	40	40	40	50	250	43.4	-	-6	3.26	G1042	DC19	AT001	
L	DCLNL 1616 H 09	16	16	16	20	100	24.8	-	-6	0.22	G1042	DC09	AT001
	DCLNL 2020 K 09	20	20	20	25	125	24.8	-	-6	0.42	G1042	DC09	AT001
	DCLNL 2525 M 09	25	25	25	32	150	24.8	-	-6	0.76	G1042	DC09	AT001
	DCLNL 1616 H 12	16	16	16	20	100	32.2	4.5	-6	0.26	G1043	DC12	AT001
	DCLNL 2020 K 12	20	20	20	25	125	32	-	-6	0.44	G1043	DC12	AT001
	DCLNL 2525 M 12	25	25	25	32	150	32	-	-6	0.78	G1043	DC12	AT001
	DCLNL 3225 P 12	32	25	32	32	170	32	-	-6	1.10	G1043	DC12	AT001
	DCLNL 2525 M 16	25	25	25	32	150	39	-	-6	0.81	G1050	DC16	AT005
	DCLNL 3225 P 16	32	25	32	32	170	39	-	-6	1.20	G1050	DC16	AT005
	DCLNL 3232 P 19	32	32	32	40	170	43.2	-	-6	1.51	G1042	DC19	AT001
DCLNL 4040 S 19	40	40	40	50	250	43.4	-	-6	3.26	G1042	DC19	AT001	



G1042

G1043



CN.. 1906..

CN.. 1204..



GI050
GI133

CN.. 1606..
CN.. 0903..



DC09
DC12
DC16
DC19
DCI12

DCS 09
DCS 12
DCS 16
DCS 19
DCS 12

1.7
3.9
6.4
6.4
3.9

DCS 236-04
DCS 234-01
DCS 234-03
DCS 236-01
DCS 236-03

US 2004-T09P
US 2002-T15P
US 2007-T20P
US 2007-T20P
US 2002-T15P

FLAG T09P
FLAG T15P/3,5
-
-
FLAG T15P/3,5

-
-
LK T20P
LK T20P
-



AT001a
AT005a
AT001b
AT001c
AT005b
AT005c

CN.. 1207..
CN.. 1607..
CER CN.N 1204..
CER CN.A 1204..
CER CN.N 1606..
CER CN.A 1606..

-
-
DCS 12C4
DCS 12C2
DCS 16C4
DCS 16C2

DCS 234-02
DCS 234-04
-
-
-
-



PCBN(RL) EXT



Utensile esterno, bloccaggio a leva, angolo del tagliente utensile 75°, inserti CN..

Utensile di tornitura esterno destro / sinistro, bloccaggio a leva, angolo del tagliente utensile 75°. Adatto per smussatura esterna, tornitura conica e longitudinale senza spallamento, utilizzando inserti CN .. 12, 16, 19 o 25 negativi. Disponibile con steli da 20x20 a 50x50 mm. Corpo trattato per una maggiore durata dell'utensile.

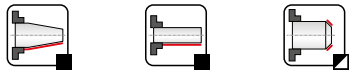
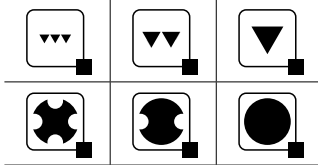
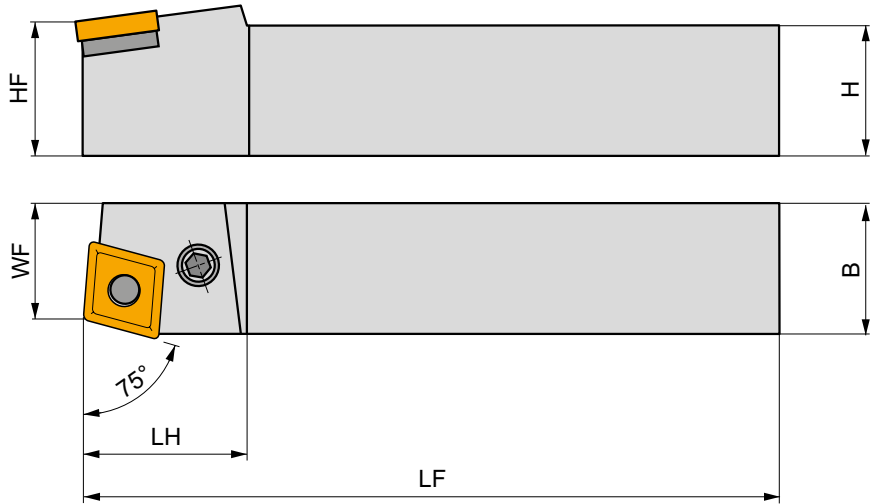
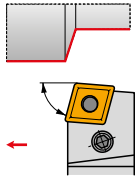

Codice prodotto	H	B	HF	WF	LF	LH	LAMS	GAMO	kg			
	(mm)	(mm)	(mm)	(mm)	(mm)	(mm)	(°)	(°)				
R	PCBNR 2020 K 12	20	20	20	17	125	36	-6	-6	0.43	G1043	PC22
	PCBNR 2525 M 12	25	25	25	22	150	36	-6	-6	0.63	G1043	PC20
	PCBNR 3225 P 12	32	25	32	22	170	36	-6	-6	0.70	G1043	PC20
	PCBNR 3232 P 16	32	32	32	27	170	40	-6	-6	1.36	G1050	PC40
	PCBNR 3232 P 19	32	32	32	27	170	45	-6	-6	1.10	G1042	PC50
	PCBNR 4040 S 19	40	40	40	35	250	45	-6	-6	3.15	G1042	PC50
	PCBNR 4040 S 25	40	40	40	35	250	45	-6	-6	3.10	G1062	PC60
	PCBNR 5050 T 25	50	50	50	43	300	50	-6	-6	5.80	G1062	PC60
L	PCBNL 2020 K 12	20	20	20	17	125	36	-6	-6	0.38	G1043	PC22
	PCBNL 2525 M 12	25	25	25	22	150	36	-6	-6	0.73	G1043	PC20
	PCBNL 3225 P 12	32	25	32	22	170	36	-6	-6	0.70	G1043	PC20
	PCBNL 3232 P 16	32	32	32	27	170	40	-6	-6	1.25	G1050	PC40
	PCBNL 3232 P 19	32	32	32	27	170	45	-6	-6	1.10	G1042	PC50
	PCBNL 4040 S 19	40	40	40	35	250	45	-6	-6	3.15	G1042	PC50
	PCBNL 4040 S 25	40	40	40	35	250	45	-6	-6	3.15	G1062	PC60
	PCBNL 5050 T 25	50	50	50	43	300	50	-6	-6	5.80	G1062	PC60



G1042

CN.. 1906..

G1043

CN.. 1204..

G1050

CN.. 1606..

G1062

CN.. 2509..



PC20

CNU 120312

PU 02

US 35

6.0

M 8x1

22.5

NT 05

MT 05

HXK 4

PC22

CNU 120312

PU 02

US 42

6.0

M 8x1

21

NT 05

MT 05

HXK 4

PC40

CNU 150312

PU 04

US 36

6.0

M 8x1

26

NT 07

MT 07

HXK 4

PC50

CNU 190416

PU 05

US 38

8.0

M 10x1

29

NT 06

MT 06

HXK 5

PC60

CNU 250620

PU 06

US 39

8.0

M 10x1

33

NT 08

MT 08

HXK 5



PCKN(RL) EXT



PRAMET

P



Utensile esterno, bloccaggio a leva, angolo del tagliente utensile 75° (sfacciare), inserti CN..

Utensile di tornitura esterno destro / sinistro, bloccaggio a leva, angolo del tagliente utensile 75°. Adatto per smussatura esterna e sfacciatura, utilizzando inserti negativi CN.. 12, 16 o 19. Disponibile con steli da 20x20 a 40x40 mm. Corpo trattato per una maggiore durata dell'utensile.

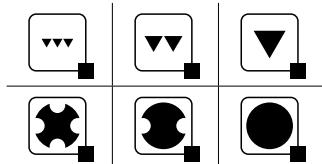
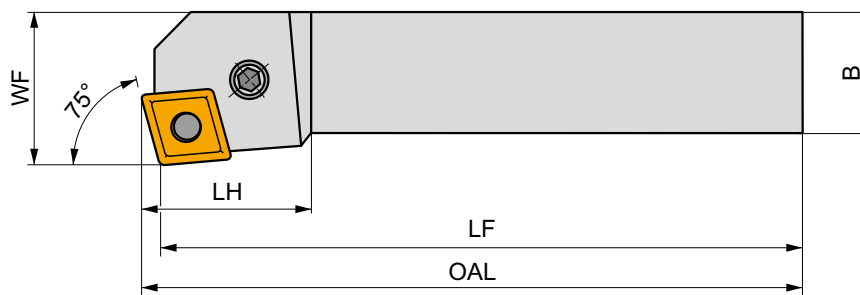
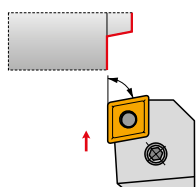

Codice prodotto	H	B	HF	WF	LF	LH	LAMS	GAMO	kg		
	(mm)	(mm)	(mm)	(mm)	(mm)	(mm)	(°)	(°)			
R PCKNR 2020 K 12	20	20	20	25	125	36	-6	-6	0.42	GI043	PC22
PCKNR 2525 M 12	25	25	25	32	150	36	-6	-6	0.79	GI043	PC20
PCKNR 3225 P 12	32	25	32	32	170	36	-6	-6	0.85	GI043	PC20
PCKNR 3232 P 16	32	32	32	40	170	40	-6	-6	1.43	GI050	PC40
PCKNR 3232 P 19	32	32	32	40	170	45	-6	-6	1.40	GI042	PC50
PCKNR 4040 S 19	40	40	40	50	250	45	-6	-6	3.25	GI042	PC50
L PCKNL 2020 K 12	20	20	20	25	125	36	-6	-6	0.42	GI043	PC22
PCKNL 2525 M 12	25	25	25	32	150	36	-6	-6	0.78	GI043	PC20
PCKNL 3225 P 12	32	25	32	32	170	36	-6	-6	1.15	GI043	PC20
PCKNL 3232 P 16	32	32	32	40	170	40	-6	-6	1.40	GI050	PC40
PCKNL 3232 P 19	32	32	32	40	170	45	-6	-6	1.40	GI042	PC50
PCKNL 4040 S 19	40	40	40	50	250	45	-6	-6	3.27	GI042	PC50



GI042
GI043
GI050

CN.. 1906..
CN.. 1204..
CN.. 1606..



PC20	CNU 120312	PU 02	US 35	6.0	M 8x1	22.5	NT 05	MT 05	HXK 4
PC22	CNU 120312	PU 02	US 42	6.0	M 8x1	21	NT 05	MT 05	HXK 4
PC40	CNU 150312	PU 04	US 36	6.0	M 8x1	26	NT 07	MT 07	HXK 4
PC50	CNU 190416	PU 05	US 38	8.0	M 10x1	29	NT 06	MT 06	HXK 5



PCLN(RL) EXT



Utensile esterno, bloccaggio a leva, angolo del tagliente utensile 95°, inserti CN..

Utensile di tornitura esterno destro / sinistro, bloccaggio a leva, angolo del tagliente utensile 95°. Adatto per conicità esterna, sfacciatura, tornitura longitudinale con spallamento e smussatura con inserti negativi CN ..12, 16, 19 o 25. Disponibile con steli da 20x20 a 50x50 mm. Corpo trattato per una maggiore durata dell'utensile.

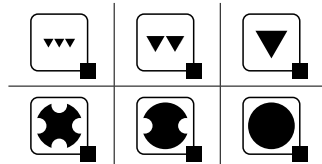
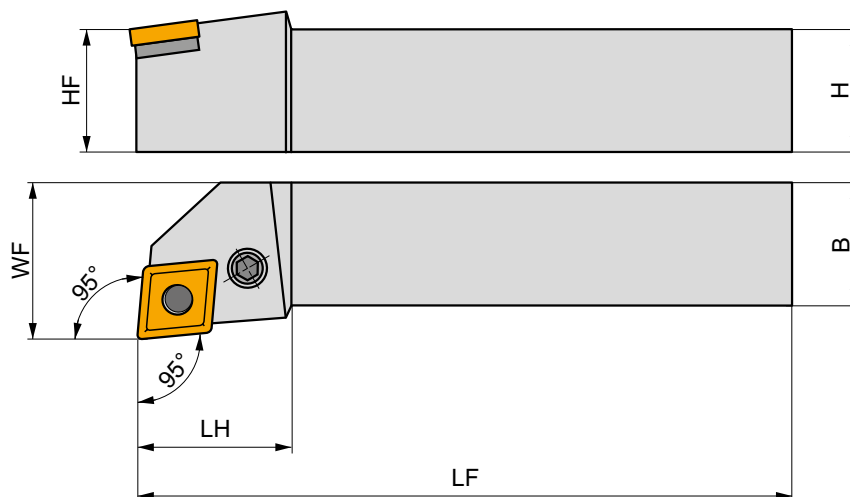
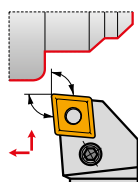

Codice prodotto	H	B	HF	WF	LF	LH	LAMS	GAMO	kg			
	(mm)	(mm)	(mm)	(mm)	(mm)	(mm)	(°)	(°)				
R	PCLNR 2020 K 12	20	20	20	25	125	36	-6	-6	0.44	GI043	PC22
	PCLNR 2525 M 12	25	25	25	32	150	36	-6	-6	0.68	GI043	PC20
	PCLNR 3225 P 12	32	25	32	32	170	36	-6	-6	0.98	GI043	PC20
	PCLNR 3225 P 16	32	25	32	32	170	40	-6	-6	1.10	GI050	PC40
	PCLNR 3232 P 19	32	32	32	40	170	45	-6	-6	1.40	GI042	PC50
	PCLNR 4040 R 19	40	40	40	50	200	45	-6	-6	2.50	GI042	PC50
	PCLNR 4040 S 19	40	40	40	50	250	45	-6	-6	3.19	GI042	PC50
	PCLNR 4040 S 25	40	40	40	50	250	45	-6	-6	3.15	GI062	PC60
	PCLNR 5050 T 25	50	50	50	60	300	50	-6	-6	5.90	GI062	PC60
	L	PCLNL 2020 K 12	20	20	20	25	125	36	-6	-6	0.42	GI043
PCLNL 2525 M 12		25	25	25	32	150	36	-6	-6	0.75	GI043	PC20
PCLNL 3225 P 12		32	25	32	32	170	36	-6	-6	1.10	GI043	PC20
PCLNL 3225 P 16		32	25	32	32	170	40	-6	-6	1.10	GI050	PC40
PCLNL 3232 P 19		32	32	32	40	170	45	-6	-6	1.42	GI042	PC50
PCLNL 4040 R 19		40	40	40	50	200	45	-6	-6	2.60	GI042	PC50
PCLNL 4040 S 19		40	40	40	50	250	45	-6	-6	3.19	GI042	PC50
PCLNL 4040 S 25		40	40	40	50	250	45	-6	-6	2.45	GI062	PC60
PCLNL 5050 T 25		50	50	50	60	300	50	-6	-6	5.90	GI062	PC60



GI042

CN.. 1906..

GI043

CN.. 1204..











GI050

CN.. 1606..

GI062

CN.. 2509..

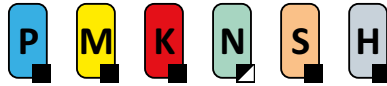

				 Nm					
PC20	CNU 120312	PU 02	US 35	6.0	M 8x1	22.5	NT 05	MT 05	HXX 4
PC22	CNU 120312	PU 02	US 42	6.0	M 8x1	21	NT 05	MT 05	HXX 4
PC40	CNU 150312	PU 04	US 36	6.0	M 8x1	26	NT 07	MT 07	HXX 4
PC50	CNU 190416	PU 05	US 38	8.0	M 10x1	29	NT 06	MT 06	HXX 5
PC60	CNU 250620	PU 06	US 39	8.0	M 10x1	33	NT 08	MT 08	HXX 5

NEW
C.-DCLN(RL) EXT

PRAMET
D

Utensile esterno PSC a cambio rapido, doppio bloccaggio, angolo di taglio 95°, per inserti CN..

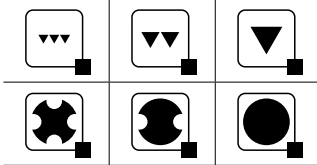
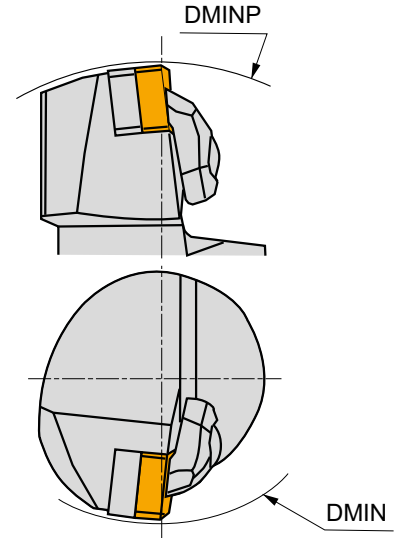
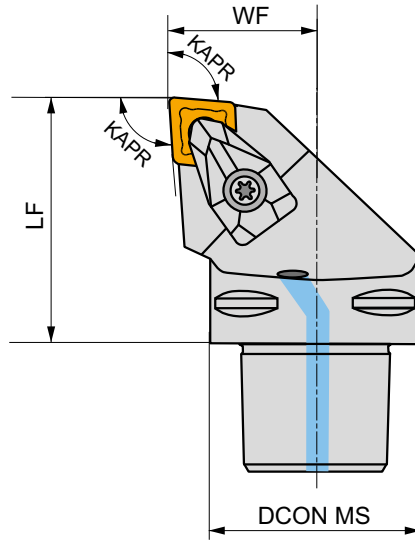
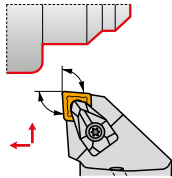
Utensile di tornitura esterno destro / sinistro, doppio bloccaggio a staffa, fori interni per refrigerante, con angolo del tagliente utensile di 95°. Per tornitura longitudinale, smussatura e sfacciatura con spallamento, utilizzando inserti CN.. negativi da 12 a 19. Attacco a cambio rapido PSC (Polygon Shank Coupling) da C3 a C8. Corpo trattato per una maggiore durata dell'utensile.



Codice prodotto	DCON MS	DMIN	DMINP	WF	LF	KAPR	LAMS	GAMO						
	(mm)	(mm)	(mm)	(mm)	(mm)	(°)	(°)	(°)						
R	C3-DCLNR-22045-12	32	60	121	22	45	95	-6	-6	✓	0.25	GI043	C-DC12	AT001
	C4-DCLNR-27050-12	40	110	140	27	50	95	-6	-6	✓	0.44	GI043	C-DC12	AT001
	C4-DCLNR-27055-16	40	125	145	27	55	95	-6	-6	✓	0.47	GI050	C-DC16	AT005
	C5-DCLNR-35060-12	50	110	165	35	60	95	-6	-6	✓	0.79	GI043	C-DC12	AT001
	C5-DCLNR-35060-16	50	125	165	35	60	95	-6	-6	✓	0.80	GI050	C-DC16	AT005
	C6-DCLNR-45065-12	63	110	190	45	65	95	-6	-6	✓	1.32	GI043	C-DC12	AT001
	C6-DCLNR-45065-16	63	125	190	45	65	95	-6	-6	✓	1.34	GI050	C-DC16	AT005
	C6-DCLNR-45065-19	63	81	190	45	65	95	-6	-6	✓	1.34	GI042	C-DC19	-
C8-DCLNR-55080-19	80	100	250	55	80	95	-6	-6	✓	2.58	GI042	C-DC19	-	
L	C4-DCLNL-27050-12	40	110	140	27	50	95	-6	-6	✓	0.44	GI043	C-DC12	AT001
	C4-DCLNL-27055-16	40	125	145	27	55	95	-6	-6	✓	0.48	GI050	C-DC16	AT005
	C5-DCLNL-35060-12	50	110	165	35	60	95	-6	-6	✓	0.79	GI043	C-DC12	AT001
	C5-DCLNL-35060-16	50	125	165	35	60	95	-6	-6	✓	0.80	GI050	C-DC16	AT005
	C6-DCLNL-45065-12	63	110	190	45	65	95	-6	-6	✓	1.32	GI043	C-DC12	AT001
	C6-DCLNL-45065-16	63	125	190	45	65	95	-6	-6	✓	1.34	GI050	C-DC16	AT005
	C6-DCLNL-45065-19	63	81	190	45	65	95	-6	-6	✓	1.34	GI042	C-DC19	-
	C8-DCLNL-55080-16	80	125	250	55	80	95	-6	-6	✓	2.58	GI050	C-DC16	AT005
C8-DCLNL-55080-19	80	100	250	55	80	95	-6	-6	✓	2.58	GI042	C-DC19	-	



GI042

CN.. 1906..









GI043





CN.. 1204..

GI050

CN.. 1606..



		 Nm					
C-DC12	DCS 12	3.9	DCS 234-01	US 2002-T15P	FLAG T15P/3,5	–	CN 045-01
C-DC16	DCS 16	6.4	DCS 234-03	US 2007-T20P	–	LK T20P	CN 045-01
C-DC19	DCS 19	6.4	DCS 236-01	US 2007-T20P	–	LK T20P	CN 045-01

			
AT001a	CN.. 1207..	–	DCS 234-02
AT005a	CN.. 1607..	–	DCS 234-04
AT001b	CER CN.N 1204..	DCS 12C4	–
AT001c	CER CN.A 1204..	DCS 12C2	–
AT005b	CER CN.N 1606..	DCS 16C4	–
AT005c	CER CN.A 1606..	DCS 16C2	–



KHP-CBN(RL)



Cartuccia di tornitura KHP, bloccaggio a leva, angolo del tagliente utensile 75°, inserti CN..

Cartuccia a coda di rondine, destra/sinistra, bloccaggio a leva, angolo del tagliente utensile 75°, si monta su stelo utensili DKH. Adatta per tornitura longitudinale pesante senza spallamento, tornitura frontale, conica e smussi con inserti negativi CN..25. Utensile trattato per una maggiore durata.

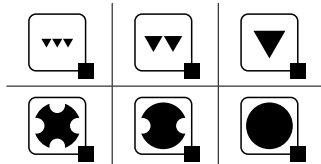
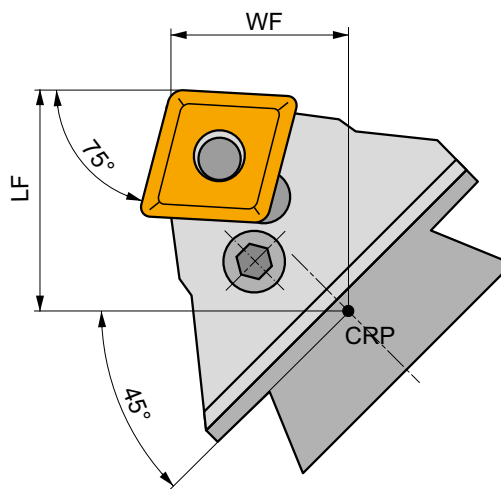
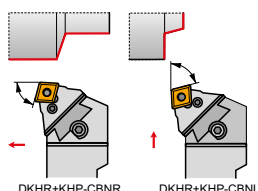

Codice prodotto	WF (mm)	LF (mm)	LAMS (°)	GAMMO (°)	kg		
R KHP-CBNR 25	32	47	-6	-6	1.54	G1062	PC60
L KHP-CBNL 25	32	47	-6	-6	1.56	G1062	PC60



G1062



CN.. 2509..



PC60



CNU 250620



PU 06



US 39



8.0



M 10x1



33



NT 08



MT 08



HXK 5



KHP-CLN(RL)



PRAMET

P



Cartuccia di tornitura KHP, bloccaggio a leva, angolo del tagliente utensile 95°, inserti CN...

Cartuccia a coda di rondine, destra/sinistra, bloccaggio a leva, angolo del tagliente utensile 95°, si monta su stelo utensili DKH. Adatta per tornitura longitudinale pesante a spallamento, tornitura frontale a spallamento, tornitura conica e smussi con inserti negativi CN.. 19 o 25. Utensile trattato per una maggiore durata.

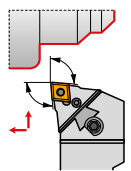

DKHR+KHP-CLNR

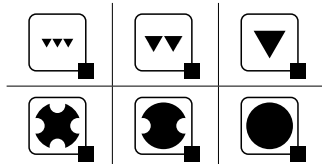
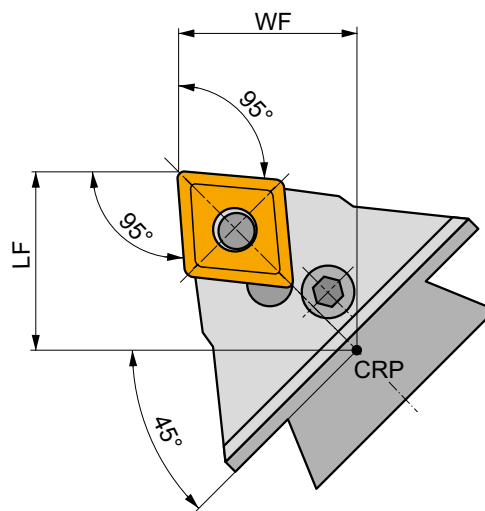

Codice prodotto		WF	LF	LAMS	GAMO	kg		
		(mm)	(mm)	(°)	(°)			
R	KHP-CLNR 19	35	45	-6	-6	1.30	GI042	PC50
	KHP-CLNR 25	35	45	-6	-6	1.25	GI062	PC60
L	KHP-CLNL 19	35	45	-6	-6	1.30	GI042	PC50
	KHP-CLNL 25	35	45	-6	-6	1.25	GI062	PC60

GI042	CN.. 1906..
GI062	CN.. 2509..

PC50	CNU 190416	PU 05	US 38	8.0	M 10x1	29	NT 06	MT 06	HXK 5
PC60	CNU 250620	PU 06	US 39	8.0	M 10x1	33	NT 08	MT 08	HXK 5



DKH(RL)



Stelo esterno per cartucce modulari KHP/KHS per tornitura pesante

Stelo modulare, destro/sinistro, a coda di rondine per cartucce KHP/KHS. Adatto per applicazioni di tornitura pesante. Dimensioni stelo 40x50 fino a 60x80mm. Corpo trattato per una durata maggiore dell'utensile.

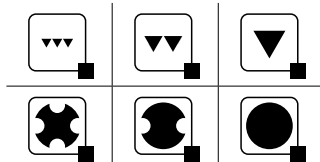
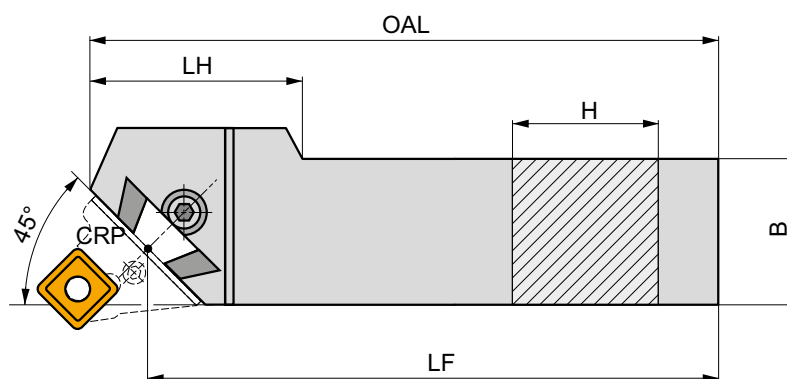
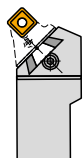

Codice prodotto	H	B	LF	OAL	LH	kg		
	(mm)	(mm)	(mm)	(mm)	(mm)			
R	DKHR 4050 V	40	50	400	425	7.10	GI098	DKH10
	DKHR 5060 W	50	60	450	475	11.30	GI098	DKH10
	DKHR 6080 W-A	60	80	450	485	19.65	GI098	DKH10
L	DKHL 4050 V	40	50	400	425	7.10	GI098	DKH10
	DKHL 5060 W	50	60	450	475	11.30	GI098	DKH10
	DKHL 6080 W-A	60	80	450	485	19.28	GI098	DKH10



GI098



KHP



KHS



DKH10



SR 14



HXK 10



DCLN(RL) INT



PRAMET

D



Utensile interno, doppio bloccaggio, per inserto CN... angolo del tagliente utensile 95°

Bareno destro/sinistro per tornitura interna con doppio bloccaggio a staffa e passaggio refrigerante interno, angolo del tagliente utensile 95° per inserti negativi CN...09 e 12. Diametro interno minimo tornibile Ø32 mm. Per operazioni di tornitura longitudinale, spallamento, conicità e smussi. Disponibile con stelo da Ø25 mm a Ø40 mm. Corpo trattato per una maggiore durata.

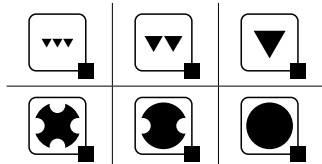
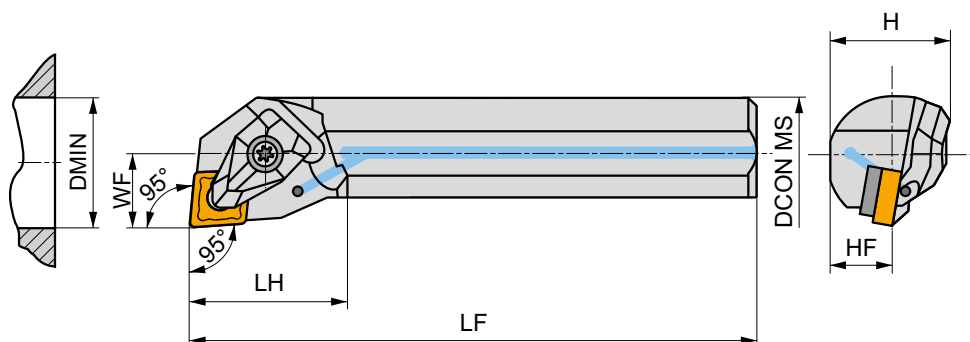
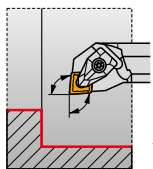

Codice prodotto	DCON MS	DMIN	WF	H	HF	LF	LH	LAMS	GAMO	✓	kg	G	DC
	(mm)	(mm)	(mm)	(mm)	(mm)	(mm)	(mm)	(°)	(°)				
R A25T-DCLNR 09	25	32	17	23	11.5	300	31	-11	-6	✓	1.13	GI133	DC09
A25T-DCLNR 12	25	32	17	23	11.5	300	31	-12	-6	✓	1.12	GI043	DC12
A32T-DCLNR 12	32	40	22	30	15	300	30	-10	-6	✓	1.68	GI043	DC12
A40T-DCLNR 12	40	50	27	37	18.5	300	32	-15	-6	✓	2.56	GI043	DC12
L A25T-DCLNL 09	25	32	17	23	11.5	300	31	-11	-6	✓	1.12	GI133	DC09
A25T-DCLNL 12	25	32	17	23	11.5	300	31	-12	-6	✓	1.11	GI043	DC12
A32T-DCLNL 12	32	40	22	30	15	300	30	-10	-6	✓	1.68	GI043	DC12
A40T-DCLNL 12	40	50	27	37	18.5	300	32	-15	-6	✓	2.56	GI043	DC12



GI043

CN.. 1204..

GI133

CN.. 0903..



DC09

DCS 09

1.7

DCS 236-04

US 2004-T09P

FLAG T09P

DC12

DCS 12

3.9

DCS 234-01

US 2002-T15P

FLAG T15P/3,5

DC112

DCS 12

3.9

DCS 236-03

US 2002-T15P

FLAG T15P/3,5



PCLN(RL) INT



PRAMET

P



Utensile interno, bloccaggio a leva, inserti CN... angolo del tagliente utensile 95°

Bareno destro/sinistro per tornitura interna con bloccaggio a leva e passaggio refrigerante interno, angolo del tagliente utensile 95° per inserti negativi CN...09, 12, 16 e 19. Diametro interno minimo tornibile Ø20 mm. Per operazioni di tornitura longitudinale, spallamento, conicità e smussi. Disponibile con stelo da Ø16 mm fino a Ø60 mm. Corpo trattato per una maggiore durata.

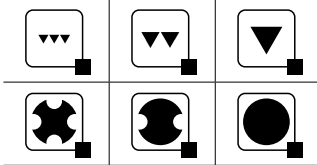
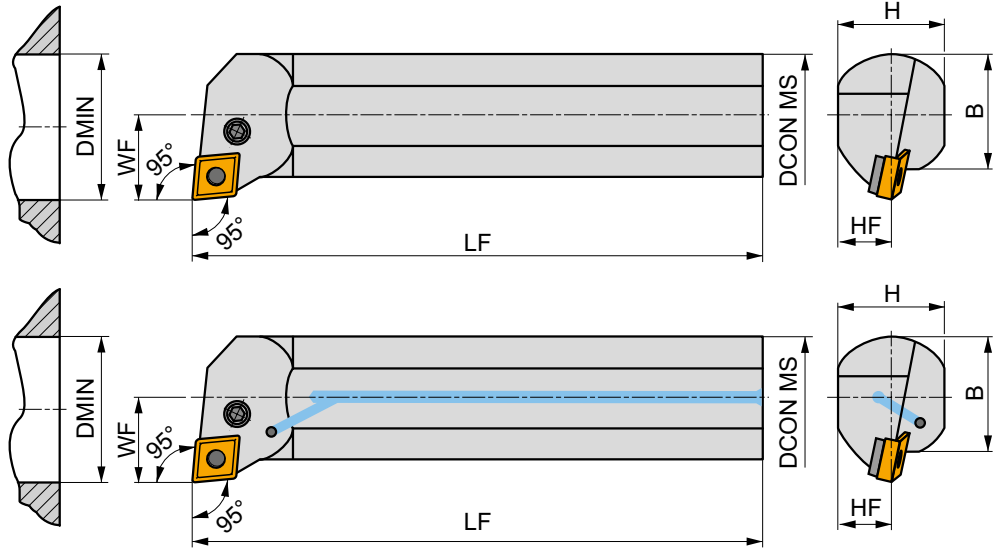
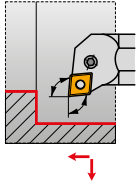

Codice prodotto	DCON MS	DMIN	WF	H	B	LF	LAMS	GAMO				
	(mm)	(mm)	(mm)	(mm)	(mm)	(mm)	(°)	(°)				
R	A16M-PCLNR 09	16	20	11	15	150	-13.5	-5	✓	0.22	GI133	PC09
	A20Q-PCLNR 09	20	25	13	18	180	-13.5	-5	✓	0.36	GI133	PC09
	A25R-PCLNR 12	25	32	17	23	200	-13	-7	✓	0.65	GI043	PC25
	S25T-PCLNR 12	25	32	17	23	300	-13	-7	–	1.10	GI043	PC25
	A32S-PCLNR 12	32	40	22	30	250	-12	-6	✓	1.48	GI043	PC21
	A40T-PCLNR 12	40	50	27	38	300	-12	-6	✓	2.40	GI043	PC20
	A40T-PCLNR 16	40	50	27	38	300	-12	-6	✓	2.90	GI050	PC41
	A50U-PCLNR 16	50	63	35	47	350	-12	-6	✓	5.20	GI050	PC40
	A60V-PCLNR 16	60	80	43	57	400	-12	-6	✓	8.70	GI050	PC40
	A50U-PCLNR 19	50	63	35	47	350	-12	-6	✓	5.20	GI042	PC50
A60V-PCLNR 19	60	80	43	57	400	-12	-6	✓	8.22	GI042	PC50	
L	A16M-PCLNL 09	16	20	11	15	150	-13.5	-5	✓	0.20	GI133	PC09
	A20Q-PCLNL 09	20	25	13	18	180	-13.5	-5	✓	0.34	GI133	PC09
	A25R-PCLNL 12	25	32	17	23	200	-13	-7	✓	0.65	GI043	PC25
	S25T-PCLNL 12	25	32	17	23	300	-13	-7	–	1.15	GI043	PC25
	A32S-PCLNL 12	32	40	22	30	250	-12	-6	✓	1.48	GI043	PC21
	A40T-PCLNL 12	40	50	27	38	300	-12	-6	✓	2.58	GI043	PC20
	A40T-PCLNL 16	40	50	27	38	300	-12	-6	✓	2.58	GI050	PC41
	A50U-PCLNL 16	50	63	35	47	350	-12	-6	✓	4.95	GI050	PC40
	A60V-PCLNL 16	60	80	43	57	400	-12	-6	✓	8.70	GI050	PC40
	A50U-PCLNL 19	50	63	35	47	350	-12	-6	✓	5.20	GI042	PC50
A60V-PCLNL 19	60	80	43	57	400	-12	-6	✓	8.40	GI042	PC50	



GI042

GI043



CN.. 1906..

CN.. 1204..



GI050

CN.. 1606..

GI133

CN.. 0903..



PC09	–	PU 8451	PS 8290	2.0	M 5	12	–	–	HXX 2
PC20	CNU 120312	PU 02	US 35	6.0	M 8x1	22.5	NT 05	MT 05	HXX 4
PC21	CNU 120312	PU 02	US 41	6.0	M 8x1	17	NT 05	MT 05	HXX 4
PC25	–	PU 32	US 46	5.0	M 6x0.75	13.2	–	–	HXX 3
PC40	CNU 150312	PU 04	US 36	6.0	M 8x1	26	NT 07	MT 07	HXX 4
PC41	CNU 150312	PU 04	US 40	6.0	M 8x1	20.5	NT 07	MT 07	HXX 4
PC50	CNU 190416	PU 05	US 38	8.0	M 10x1	29	NT 06	MT 06	HXX 5

NEW
C.-DCLN(RL) INT

D

Utensile PSC interno a cambio rapido, doppio bloccaggio per inserto CN... angolo del tagliente ut. 95°

Utensile destro/sinistro per tornitura interna con doppio bloccaggio e passaggio refrigerante interno, angolo del tagliente utensile 95° per inserti negativi da CN...09 a CN...16. Diametro interno minimo tornibile Ø25 mm. Adatto per un'ampia gamma di applicazioni di tornitura interna. Attacco PSC (Attacco Poligonale) da C4 a C6 con lunghezze diverse. Corpo trattato per una maggiore durata.

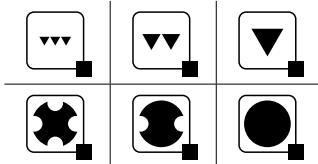
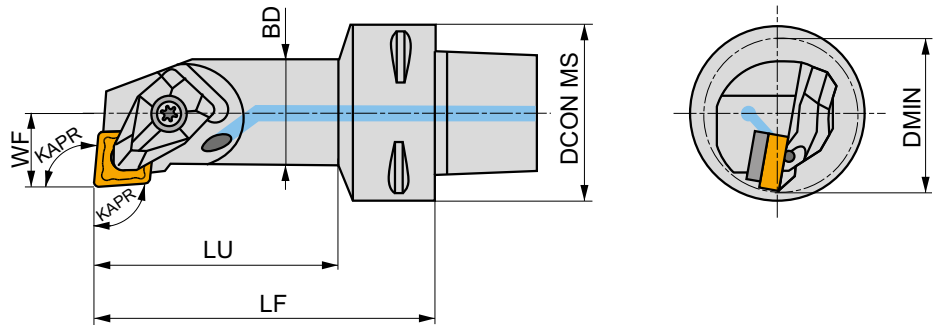
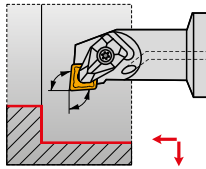

Codice prodotto	DCON MS	DMIN	WF	LF	LU	BD	KAPR	LAMS	GAMO					
	(mm)	(mm)	(mm)	(mm)	(mm)	(mm)	(°)	(°)	(°)					
R	C4-DCLNR-13080-09	40	25	13	80	57	20	95	-14	-6	✓	0.43	GI133	DC09
	C4-DCLNR-17090-12	40	32	17	90	68	25	95	-12	-6	✓	0.53	GI043	DC12
	C5-DCLNR-17090-12	50	32	17	90	66	25	95	-12	-6	✓	0.72	GI043	DC12
	C6-DCLNR-17100-12	63	32	17	100	72	25	95	-12	-6	✓	1.15	GI043	DC12
C6-DCLNR-27140-16	63	50	27	140	114	40	95	-16	-6	✓	1.81	GI050	DC16	
L	C4-DCLNL-17090-12	40	32	17	90	68	25	95	-12	-6	✓	0.53	GI043	DC12
	C5-DCLNL-17090-12	50	32	17	90	66	25	95	-12	-6	✓	0.72	GI043	DC12



GI043	CN.. 1204..
GI050	CN.. 1606..
GI133	CN.. 0903..









DC09	DCS 09	1.7	DCS 236-04	US 2004-T09P	FLAGT09P	-
DC16	DCS 16	6.4	DCS 234-03	US 2007-T20P	-	LKT20P
DC12	DCS 12	3.9	DCS 236-03	US 2002-T15P	FLAG T15P/3,5	-







DN

11/ 15

INSERTI IN METALLO DURO

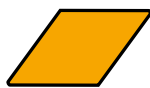
DNMA	DNMG	DNMM
		
 260	 260	 270











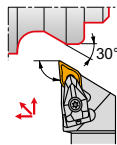
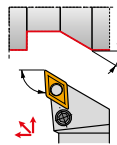
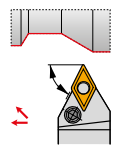
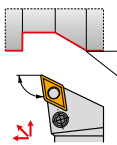





INSERTI CER E CBN

DNGA CER	DNGN CER	DNGA CBN
		
 271	 271	 272





ABBINAMENTO DELLA DIMENSIONE CORRETTA (esempio)

Inserto	Portainsero
DNMG 150404E-SF	DDJNL 2020 K 15



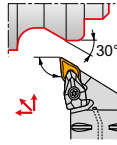

TORNITURA ISO - ESTERNA

DDJN(RL) EXT	PDJN(RL) EXT	PDNN(RL) EXT	PDXN(RL) EXT
93°	93°	62°30'	98°
			
DN..  11 15	DN..  11 15	DN..  11 15	DN..  15
 20×20 32×32	 20×20 32×32	 20×20 32×25	 20×20 32×25
 273	 274	 275	 276
 260-272	 260-272	 260-272	 260-272



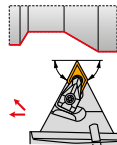

C.-DDJN(RL) EXT **NEW**

93°	DN..
	 11 15
 C4 C6	 277
	 260-272

C.-DDNNN EXT **NEW**

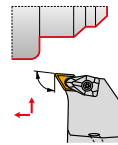
62,5°	DN..
	 15
 C5 C6	 278
	 260-272

C.-DDUN(RL) EXT **NEW**

93°	DN..
	 15
 C5 C6	 279
	 260-272



DN

11/ 15

TORNITURA ISO INTERNA

DDUN(RL) INT

93°

DN..

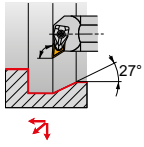
 11
15

 25
50

280



260 - 272

PDUN(RL) INT

93°

DN..

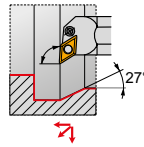
 11
15

 25
60

281



260 - 272

C.-DDUN(RL) INT **NEW**

93°

DN..



11

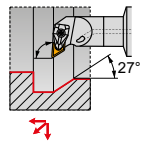

12



282



260 - 272



DNMA

	IC (mm)	D1 (mm)	L (mm)	S (mm)
1504	12.700	5.16	15.50	4.76
1506	12.700	5.16	15.50	6.35

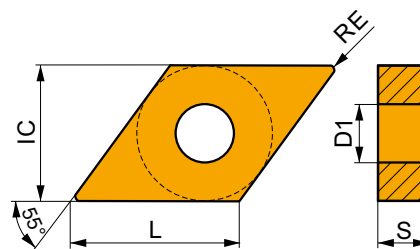

Idoneità e valori iniziali per velocità di taglio (Vc), avanzamento (f) e profondità di taglio (ap). Fare riferimento alla nostra App Machining Calculator per ulteriori calcoli.

Codice prodotto	RE	P			M			K			N			S			H		
		vc (m/min)	f (mm/rev)	ap (mm)	vc (m/min)	f (mm/rev)	ap (mm)	vc (m/min)	f (mm/rev)	ap (mm)	vc (m/min)	f (mm/rev)	ap (mm)	vc (m/min)	f (mm/rev)	ap (mm)	vc (m/min)	f (mm/rev)	ap (mm)

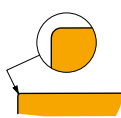

Adatta per operazioni da finitura fino a semi sgrossatura, da taglio continuo a leggermente interrotto.

DNMA 150404	T5305	0.4	–	–	–	–	–	–	205	0.10	1.7	–	–	–	–	–	–	–	40	0.15	1.0
DNMA 150408	T5305	0.8	–	–	–	–	–	–	190	0.20	1.7	–	–	–	–	–	–	–	40	0.15	1.0
	T5315	0.8	–	–	–	–	–	–	165	0.20	1.7	–	–	–	–	–	–	–	35	0.15	1.0
DNMA 150604	T5305	0.4	–	–	–	–	–	–	205	0.10	1.7	–	–	–	–	–	–	–	40	0.15	1.0
	T5315	0.4	–	–	–	–	–	–	180	0.10	1.7	–	–	–	–	–	–	–	35	0.15	1.0
	T6310	0.4	–	–	–	–	–	–	85	0.10	1.7	–	–	–	–	–	–	–	20	0.15	1.0
DNMA 150608	T5305	0.8	–	–	–	–	–	–	190	0.20	1.7	–	–	–	–	–	–	–	40	0.15	1.0
	T5315	0.8	–	–	–	–	–	–	165	0.20	1.7	–	–	–	–	–	–	–	35	0.15	1.0
	T6310	0.8	–	–	–	–	–	–	85	0.20	1.7	–	–	–	–	–	–	–	20	0.15	1.0
DNMA 150612	T5305	1.2	–	–	–	–	–	–	200	0.20	1.7	–	–	–	–	–	–	–	40	0.15	1.0
	T5315	1.2	–	–	–	–	–	–	175	0.20	1.7	–	–	–	–	–	–	–	35	0.15	1.0

DNMG

	IC (mm)	D1 (mm)	L (mm)	S (mm)
1104	9.525	3.81	11.60	4.76
1504	12.700	5.16	15.50	4.76
1506	12.700	5.16	15.50	6.35

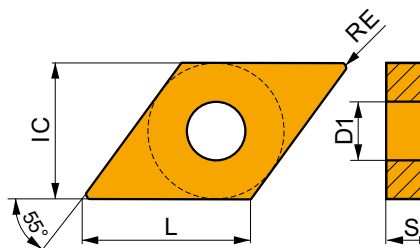

Idoneità e valori iniziali per velocità di taglio (Vc), avanzamento (f) e profondità di taglio (ap). Fare riferimento alla nostra App Machining Calculator per ulteriori calcoli.

Codice prodotto	RE	P			M			K			N			S			H		
		vc (m/min)	f (mm/rev)	ap (mm)	vc (m/min)	f (mm/rev)	ap (mm)	vc (m/min)	f (mm/rev)	ap (mm)	vc (m/min)	f (mm/rev)	ap (mm)	vc (m/min)	f (mm/rev)	ap (mm)	vc (m/min)	f (mm/rev)	ap (mm)

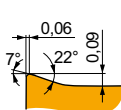

FF geometria altamente positiva per operazioni di super finitura, da taglio continuo a leggermente interrotto.

DNMG 110402E-FF	T8315	0.2	✓	175	0.10	0.8	■	105	0.09	0.8	✓	165	0.10	0.8	–	–	–	–	–	–	–
DNMG 110404E-FF	T8315	0.4	✓	175	0.12	0.8	■	105	0.11	0.8	✓	165	0.12	0.8	–	–	–	–	–	–	–
	T8330	0.4	■	165	0.12	0.8	■	95	0.11	0.8	✓	155	0.12	0.8	–	–	–	–	–	–	–
	T8430	0.4	■	205	0.12	0.8	■	110	0.11	0.8	✓	170	0.12	0.8	–	–	–	–	–	–	–
DNMG 110408E-FF	T8315	0.8	✓	200	0.15	0.8	■	120	0.14	0.8	✓	190	0.15	0.8	–	–	–	–	–	–	–



Idoneità e valori iniziali per velocità di taglio (Vc), avanzamento (f) e profondità di taglio (ap). Fare riferimento alla nostra App Machining Calculator per ulteriori calcoli.

Codice prodotto	RE (mm)	P			M			K			N			S			H		
		vc (m/min)	f (mm/rev)	ap (mm)	vc (m/min)	f (mm/rev)	ap (mm)	vc (m/min)	f (mm/rev)	ap (mm)	vc (m/min)	f (mm/rev)	ap (mm)	vc (m/min)	f (mm/rev)	ap (mm)	vc (m/min)	f (mm/rev)	ap (mm)

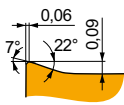

FF geometria altamente positiva per operazioni di super finitura, da taglio continuo a leggermente interrotto.

DNMG 150404E-FF	T8315	0.4	175	0.12	1.0	105	0.11	1.0	165	0.12	1.0	-	-	-	-	-	-	-
DNMG 150604E-FF	T7325	0.4	190	0.12	1.0	145	0.11	1.0	-	-	-	-	-	-	-	-	-	-
	T8315	0.4	175	0.12	1.0	105	0.11	1.0	165	0.12	1.0	-	-	-	-	-	-	-
DNMG 150608E-FF	T7325	0.8	210	0.15	1.0	160	0.14	1.0	-	-	-	-	-	-	-	-	-	-
	T8315	0.8	195	0.15	1.0	115	0.14	1.0	185	0.15	1.0	-	-	-	-	-	-	-

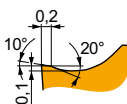

FM geometria positiva per operazioni da finitura fino a semi sgrassatura, da taglio continuo a leggermente interrotto.

DNMG 110404E-FM	T7325	0.4	165	0.20	0.8	125	0.18	0.8	-	-	-	50	0.20	0.6	-	-	-
	T8315	0.4	150	0.20	0.8	90	0.18	0.8	140	0.20	0.8	35	0.14	0.6	-	-	-
	T8330	0.4	145	0.20	0.8	85	0.18	0.8	135	0.20	0.8	35	0.14	0.6	-	-	-
	T8430	0.4	165	0.20	0.8	90	0.18	0.8	135	0.20	0.8	35	0.14	0.6	-	-	-
	T9310	0.4	245	0.20	0.8	-	-	-	230	0.20	0.8	-	-	-	-	-	-
	T9315	0.4	225	0.20	0.8	-	-	-	210	0.20	0.8	-	-	-	-	-	-
	T9325	0.4	200	0.20	0.8	120	0.18	0.8	190	0.20	0.8	45	0.20	0.6	-	-	-
DNMG 110408E-FM	T7325	0.8	200	0.20	0.8	155	0.18	0.8	-	-	-	65	0.16	0.6	-	-	-
	T8315	0.8	180	0.20	0.8	105	0.18	0.8	170	0.20	0.8	45	0.14	0.6	-	-	-
	T8330	0.8	175	0.20	0.8	105	0.18	0.8	165	0.20	0.8	40	0.14	0.6	-	-	-
	T8430	0.8	195	0.20	0.8	105	0.18	0.8	160	0.20	0.8	40	0.14	0.6	-	-	-
	T9310	0.8	295	0.20	0.8	-	-	-	280	0.20	0.8	-	-	-	-	-	-
	T9315	0.8	270	0.20	0.8	-	-	-	255	0.20	0.8	-	-	-	-	-	-
	T9325	0.8	240	0.20	0.8	140	0.18	0.8	225	0.20	0.8	50	0.16	0.6	-	-	-
DNMG 150404E-FM	T7325	0.4	150	0.20	1.7	115	0.18	1.7	-	-	-	45	0.20	1.4	-	-	-
	T8330	0.4	135	0.20	1.7	80	0.18	1.7	125	0.20	1.7	30	0.14	1.4	-	-	-
	T8430	0.4	150	0.20	1.7	80	0.18	1.7	125	0.20	1.7	30	0.14	1.4	-	-	-
	T9315	0.4	210	0.20	1.7	-	-	-	195	0.20	1.7	-	-	-	-	-	-
	T9325	0.4	190	0.20	1.7	110	0.18	1.7	180	0.20	1.7	40	0.20	1.4	-	-	-
	T9325	0.4	190	0.20	1.7	110	0.18	1.7	180	0.20	1.7	40	0.20	1.4	-	-	-
DNMG 150408E-FM	T7325	0.8	180	0.20	1.7	140	0.18	1.7	-	-	-	55	0.16	1.4	-	-	-
	T8330	0.8	160	0.20	1.7	95	0.18	1.7	150	0.20	1.7	40	0.16	1.4	-	-	-
	T8430	0.8	185	0.20	1.7	100	0.18	1.7	150	0.20	1.7	40	0.16	1.4	-	-	-
	T9315	0.8	250	0.20	1.7	-	-	-	235	0.20	1.7	-	-	-	-	-	-
	T9325	0.8	225	0.20	1.7	135	0.18	1.7	210	0.20	1.7	50	0.16	1.4	-	-	-
DNMG 150604E-FM	T7325	0.4	150	0.20	1.7	115	0.18	1.7	-	-	-	45	0.20	1.4	-	-	-
	T7335	0.4	150	0.20	1.7	115	0.18	1.7	-	-	-	45	0.20	1.4	-	-	-
	T8315	0.4	140	0.20	1.7	80	0.18	1.7	130	0.20	1.7	35	0.14	1.4	-	-	-
	T8330	0.4	135	0.20	1.7	80	0.18	1.7	125	0.20	1.7	30	0.14	1.4	-	-	-
	T8430	0.4	150	0.20	1.7	80	0.18	1.7	125	0.20	1.7	30	0.14	1.4	-	-	-
	T9310	0.4	230	0.20	1.7	-	-	-	215	0.20	1.7	-	-	-	-	-	-
	T9315	0.4	210	0.20	1.7	-	-	-	195	0.20	1.7	-	-	-	-	-	-
	T9325	0.4	190	0.20	1.7	110	0.18	1.7	180	0.20	1.7	40	0.20	1.4	-	-	-
	TT310	0.4	210	0.20	1.7	125	0.18	1.7	-	-	-	-	-	-	-	-	-
	T9325	0.4	190	0.20	1.7	110	0.18	1.7	180	0.20	1.7	40	0.20	1.4	-	-	-
DNMG 150608E-FM	T7325	0.8	180	0.20	1.7	140	0.18	1.7	-	-	-	55	0.16	1.4	-	-	-
	T7335	0.8	175	0.20	1.7	135	0.18	1.7	-	-	-	55	0.16	1.4	-	-	-
	T8315	0.8	170	0.20	1.7	100	0.18	1.7	160	0.20	1.7	40	0.16	1.4	-	-	-
	T8330	0.8	160	0.20	1.7	95	0.18	1.7	150	0.20	1.7	40	0.16	1.4	-	-	-
	T8430	0.8	185	0.20	1.7	100	0.18	1.7	150	0.20	1.7	40	0.16	1.4	-	-	-
	T9310	0.8	275	0.20	1.7	-	-	-	260	0.20	1.7	-	-	-	-	-	-
	T9315	0.8	250	0.20	1.7	-	-	-	235	0.20	1.7	-	-	-	-	-	-
	T9325	0.8	225	0.20	1.7	135	0.18	1.7	210	0.20	1.7	50	0.16	1.4	-	-	-
	TT310	0.8	250	0.20	1.7	150	0.18	1.7	-	-	-	-	-	-	-	-	-
	T9325	0.8	225	0.20	1.7	135	0.18	1.7	210	0.20	1.7	50	0.16	1.4	-	-	-
DNMG 150612E-FM	T7325	1.2	180	0.25	1.7	140	0.23	1.7	-	-	-	55	0.18	1.4	-	-	-
	T8430	1.2	175	0.25	1.7	95	0.23	1.7	140	0.25	1.7	35	0.18	1.4	-	-	-
	T9310	1.2	260	0.25	1.7	-	-	-	245	0.25	1.7	-	-	-	-	-	-
	T9315	1.2	240	0.25	1.7	-	-	-	225	0.25	1.7	-	-	-	-	-	-
	T9325	1.2	215	0.25	1.7	125	0.23	1.7	200	0.25	1.7	45	0.18	1.4	-	-	-



Idoneità e valori iniziali per velocità di taglio (Vc), avanzamento (f) e profondità di taglio (ap). Fare riferimento alla nostra App Machining Calculator per ulteriori calcoli.

Codice prodotto	RE  (mm)	P			M			K			N			S			H		
		vc (m/min)	f (mm/rev)	ap (mm)	vc (m/min)	f (mm/rev)	ap (mm)	vc (m/min)	f (mm/rev)	ap (mm)	vc (m/min)	f (mm/rev)	ap (mm)	vc (m/min)	f (mm/rev)	ap (mm)	vc (m/min)	f (mm/rev)	ap (mm)

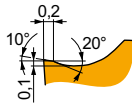

FM geometria positiva per operazioni da finitura fino a semi sgrossatura, da taglio continuo a leggermente interrotto.

DNMG 150616E-FM	T9315	1.6	235	0.30	1.7	—	—	—	220	0.30	1.7	—	—	—	—	—	—	—	—
	T9325	1.6	210	0.30	1.7	125	0.27	1.7	195	0.30	1.7	—	—	45	0.21	1.4	—	—	—

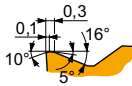

M geometria per operazioni da finitura fino a semi sgrossatura, da taglio continuo a interrotto.

DNMG 110404E-M	T5315	0.4	210	0.20	1.2	—	—	—	195	0.20	1.2	—	—	—	—	—	40	0.15	1.0
	T9315	0.4	195	0.20	1.2	—	—	—	185	0.20	1.2	—	—	—	—	—	35	0.15	1.0
	T9325	0.4	175	0.20	1.2	—	—	—	165	0.20	1.2	—	—	—	—	—	—	—	—
	T9335	0.4	150	0.20	1.2	—	—	—	—	—	—	—	—	—	—	—	—	—	—
DNMG 110408E-M	T5315	0.8	215	0.30	1.2	—	—	—	200	0.30	1.2	—	—	—	—	—	40	0.15	1.0
	T9315	0.8	200	0.30	1.2	—	—	—	190	0.30	1.2	—	—	—	—	—	40	0.15	1.0
	T9325	0.8	175	0.30	1.2	—	—	—	165	0.30	1.2	—	—	—	—	—	—	—	—
	T9335	0.8	155	0.30	1.2	—	—	—	—	—	—	—	—	—	—	—	—	—	—
DNMG 110412E-M	T9315	1.2	185	0.40	1.2	—	—	—	175	0.40	1.2	—	—	—	—	—	35	0.15	1.0
	T9325	1.2	165	0.40	1.2	—	—	—	155	0.40	1.2	—	—	—	—	—	—	—	—
	T9335	1.2	140	0.40	1.2	—	—	—	—	—	—	—	—	—	—	—	—	—	—
DNMG 150404E-M	T5315	0.4	200	0.20	1.9	—	—	—	190	0.20	1.9	—	—	—	—	—	40	0.15	1.0
	T9315	0.4	190	0.20	1.9	—	—	—	180	0.20	1.9	—	—	—	—	—	35	0.15	1.0
	T9325	0.4	170	0.20	1.9	—	—	—	160	0.20	1.9	—	—	—	—	—	—	—	—
	T9335	0.4	145	0.20	1.9	—	—	—	—	—	—	—	—	—	—	—	—	—	—
DNMG 150408E-M	T5315	0.8	205	0.30	1.9	—	—	—	190	0.30	1.9	—	—	—	—	—	40	0.15	1.0
	T9315	0.8	190	0.30	1.9	—	—	—	180	0.30	1.9	—	—	—	—	—	35	0.15	1.0
	T9325	0.8	170	0.30	1.9	—	—	—	160	0.30	1.9	—	—	—	—	—	—	—	—
	T9335	0.8	145	0.30	1.9	—	—	—	—	—	—	—	—	—	—	—	—	—	—
DNMG 150412E-M	T5315	1.2	200	0.40	1.9	—	—	—	190	0.40	1.9	—	—	—	—	—	40	0.15	1.0
	T9315	1.2	175	0.40	1.9	—	—	—	165	0.40	1.9	—	—	—	—	—	35	0.15	1.0
	T9325	1.2	160	0.40	1.9	—	—	—	150	0.40	1.9	—	—	—	—	—	—	—	—
DNMG 150604E-M	T5315	0.4	200	0.20	1.9	—	—	—	190	0.20	1.9	—	—	—	—	—	40	0.15	1.0
	T9315	0.4	190	0.20	1.9	—	—	—	180	0.20	1.9	—	—	—	—	—	35	0.15	1.0
	T9325	0.4	170	0.20	1.9	—	—	—	160	0.20	1.9	—	—	—	—	—	—	—	—
	T9335	0.4	145	0.20	1.9	—	—	—	—	—	—	—	—	—	—	—	—	—	—
DNMG 150608E-M	T5315	0.8	205	0.30	1.9	—	—	—	190	0.30	1.9	—	—	—	—	—	40	0.15	1.0
	T9310	0.8	205	0.30	1.9	—	—	—	190	0.30	1.9	—	—	—	—	—	40	0.15	1.0
	T9315	0.8	190	0.30	1.9	—	—	—	180	0.30	1.9	—	—	—	—	—	35	0.15	1.0
	T9325	0.8	170	0.30	1.9	—	—	—	160	0.30	1.9	—	—	—	—	—	—	—	—
	T9335	0.8	145	0.30	1.9	—	—	—	—	—	—	—	—	—	—	—	—	—	—
DNMG 150612E-M	T5315	1.2	200	0.40	1.9	—	—	—	190	0.40	1.9	—	—	—	—	—	40	0.15	1.0
	T9310	1.2	190	0.40	1.9	—	—	—	180	0.40	1.9	—	—	—	—	—	35	0.15	1.0
	T9315	1.2	175	0.40	1.9	—	—	—	165	0.40	1.9	—	—	—	—	—	35	0.15	1.0
	T9325	1.2	160	0.40	1.9	—	—	—	150	0.40	1.9	—	—	—	—	—	—	—	—
	T9335	1.2	140	0.40	1.9	—	—	—	—	—	—	—	—	—	—	—	—	—	—

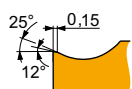

NF geometria con design altamente positivo per operazioni da finitura fino a medie lavorazioni, taglio continuo.

DNMG 110404E-NF	T6310	0.4	155	0.15	0.8	110	0.14	0.8	125	0.15	0.8	465	0.18	0.8	45	0.12	0.6	—	—
	T7325	0.4	170	0.18	0.8	130	0.16	0.8	—	—	—	—	—	—	55	0.16	0.6	—	—
	T7335	0.4	165	0.18	0.8	125	0.16	0.8	—	—	—	—	—	—	50	0.16	0.6	—	—
	T8330	0.4	160	0.15	0.8	95	0.14	0.8	150	0.15	0.8	480	0.18	0.8	40	0.12	0.6	—	—
	T8430	0.4	190	0.15	0.8	105	0.14	0.8	155	0.15	0.8	525	0.18	0.8	40	0.12	0.6	—	—
	T9315	0.4	255	0.15	0.8	—	—	—	240	0.15	0.8	—	—	—	—	—	—	—	—
	T9325	0.4	210	0.18	0.8	125	0.16	0.8	195	0.18	0.8	—	—	—	45	0.16	0.6	—	—
	T9335	0.4	140	0.15	0.8	—	—	—	—	—	—	—	—	—	—	—	—	—	—



Idoneità e valori iniziali per velocità di taglio (Vc), avanzamento (f) e profondità di taglio (ap). Fare riferimento alla nostra App Machining Calculator per ulteriori calcoli.

Codice prodotto	RE (mm)	P			M			K			N			S			H		
		vc (m/min)	f (mm/rev)	ap (mm)	vc (m/min)	f (mm/rev)	ap (mm)	vc (m/min)	f (mm/rev)	ap (mm)	vc (m/min)	f (mm/rev)	ap (mm)	vc (m/min)	f (mm/rev)	ap (mm)	vc (m/min)	f (mm/rev)	ap (mm)

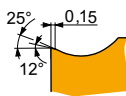

NF geometria con design altamente positivo per operazioni da finitura fino a medie lavorazioni, taglio continuo.

DNMG 110408E-NF	T6310	0.8	█	175	0.17	1.0	█	125	0.15	1.0	█	140	0.17	1.0	█	525	0.20	1.0	█	50	0.14	0.8	-	-	-	
	T7325	0.8	█	200	0.18	1.0	█	155	0.16	1.0	█	-	-	-	█	65	0.16	0.8	█	-	-	-	-	-	-	
	T7335	0.8	█	195	0.18	1.0	█	150	0.16	1.0	█	-	-	-	█	60	0.16	0.8	█	-	-	-	-	-	-	
	T8330	0.8	█	175	0.17	1.0	█	105	0.15	1.0	█	165	0.17	1.0	█	525	0.20	1.0	█	40	0.14	0.8	-	-	-	
	T8430	0.8	█	205	0.17	1.0	█	110	0.15	1.0	█	170	0.17	1.0	█	570	0.20	1.0	█	45	0.14	0.8	-	-	-	
	T9315	0.8	█	280	0.17	1.0	█	-	-	-	█	265	0.17	1.0	█	-	-	-	█	-	-	-	-	-	-	
	T9325	0.8	█	250	0.18	1.0	█	150	0.16	1.0	█	235	0.18	1.0	█	-	-	-	█	55	0.16	0.8	-	-	-	
	DNMG 150404E-NF	T6310	0.4	█	140	0.17	1.7	█	100	0.15	1.7	█	110	0.17	1.7	█	420	0.20	1.7	█	40	0.15	1.4	-	-	-
		T7325	0.4	█	160	0.18	1.7	█	120	0.16	1.7	█	-	-	-	█	50	0.16	1.4	█	-	-	-	-	-	
T7335		0.4	█	155	0.18	1.7	█	120	0.16	1.7	█	-	-	-	█	50	0.16	1.4	█	-	-	-	-	-		
T8330		0.4	█	140	0.17	1.7	█	80	0.15	1.7	█	130	0.17	1.7	█	420	0.20	1.7	█	35	0.15	1.4	-	-	-	
T8430		0.4	█	165	0.17	1.7	█	90	0.15	1.7	█	135	0.17	1.7	█	450	0.20	1.7	█	35	0.15	1.4	-	-	-	
T9315		0.4	█	235	0.15	1.7	█	-	-	-	█	220	0.15	1.7	█	-	-	-	█	-	-	-	-	-	-	
T9325		0.4	█	200	0.18	1.7	█	120	0.16	1.7	█	190	0.18	1.7	█	-	-	-	█	45	0.16	1.4	-	-	-	
DNMG 150408E-NF		T6310	0.8	█	165	0.18	1.7	█	115	0.16	1.7	█	130	0.18	1.7	█	495	0.22	1.7	█	45	0.16	1.4	-	-	-
		T7325	0.8	█	190	0.18	1.7	█	145	0.16	1.7	█	-	-	-	█	60	0.16	1.4	█	-	-	-	-	-	
	T7335	0.8	█	185	0.18	1.7	█	140	0.16	1.7	█	-	-	-	█	60	0.16	1.4	█	-	-	-	-	-		
	T8330	0.8	█	165	0.18	1.7	█	95	0.16	1.7	█	155	0.18	1.7	█	495	0.22	1.7	█	40	0.16	1.4	-	-	-	
	T8430	0.8	█	190	0.18	1.7	█	105	0.16	1.7	█	155	0.18	1.7	█	525	0.22	1.7	█	40	0.16	1.4	-	-	-	
	T9315	0.8	█	270	0.17	1.7	█	-	-	-	█	255	0.17	1.7	█	-	-	-	█	-	-	-	-	-	-	
	T9325	0.8	█	235	0.18	1.7	█	140	0.16	1.7	█	220	0.18	1.7	█	-	-	-	█	50	0.16	1.4	-	-	-	
	DNMG 150604E-NF	HF7	0.4	-	-	-	█	80	0.14	1.9	█	130	0.15	1.9	█	420	0.18	1.9	█	-	-	-	-	-	-	
		T6310	0.4	█	140	0.17	1.9	█	100	0.15	1.9	█	110	0.17	1.9	█	420	0.20	1.9	█	40	0.15	1.5	-	-	-
T7325		0.4	█	155	0.18	1.9	█	120	0.16	1.9	█	-	-	-	█	50	0.16	1.5	█	-	-	-	-	-		
T7335		0.4	█	150	0.18	1.9	█	115	0.16	1.9	█	-	-	-	█	45	0.16	1.5	█	-	-	-	-	-		
T8315		0.4	█	145	0.17	1.9	█	85	0.15	1.9	█	135	0.17	1.9	█	435	0.20	1.9	█	35	0.15	1.5	-	-	-	
T8330		0.4	█	140	0.17	1.9	█	80	0.15	1.9	█	130	0.17	1.9	█	420	0.20	1.9	█	35	0.15	1.5	-	-	-	
T8430		0.4	█	165	0.17	1.9	█	90	0.15	1.9	█	135	0.17	1.9	█	450	0.20	1.9	█	35	0.15	1.5	-	-	-	
T9315		0.4	█	235	0.15	1.9	█	-	-	-	█	220	0.15	1.9	█	-	-	-	█	-	-	-	-	-	-	
T9325		0.4	█	195	0.18	1.9	█	115	0.16	1.9	█	185	0.18	1.9	█	-	-	-	█	40	0.16	1.5	-	-	-	
DNMG 150608E-NF	HF7	0.8	-	-	-	█	90	0.15	1.9	█	145	0.17	1.9	█	465	0.20	1.9	█	-	-	-	-	-	-		
	T6310	0.8	█	165	0.18	1.9	█	115	0.16	1.9	█	130	0.18	1.9	█	495	0.22	1.9	█	45	0.16	1.5	-	-	-	
	T7325	0.8	█	185	0.18	1.9	█	140	0.16	1.9	█	-	-	-	█	60	0.16	1.5	█	-	-	-	-	-		
	T7335	0.8	█	180	0.18	1.9	█	140	0.16	1.9	█	-	-	-	█	55	0.16	1.5	█	-	-	-	-	-		
	T8315	0.8	█	175	0.18	1.9	█	105	0.16	1.9	█	165	0.18	1.9	█	525	0.22	1.9	█	40	0.16	1.5	-	-	-	
	T8330	0.8	█	165	0.18	1.9	█	95	0.16	1.9	█	155	0.18	1.9	█	495	0.22	1.9	█	40	0.16	1.5	-	-	-	
	T8430	0.8	█	190	0.18	1.9	█	105	0.16	1.9	█	155	0.18	1.9	█	525	0.22	1.9	█	40	0.16	1.5	-	-	-	
	T9315	0.8	█	265	0.17	1.9	█	-	-	-	█	250	0.17	1.9	█	-	-	-	█	-	-	-	-	-	-	
	T9325	0.8	█	230	0.18	1.9	█	135	0.16	1.9	█	215	0.18	1.9	█	-	-	-	█	50	0.16	1.5	-	-	-	
DNMG 150612E-NF	T6310	1.2	█	150	0.30	1.5	█	105	0.27	1.5	█	120	0.30	1.5	█	450	0.36	1.5	█	45	0.21	1.2	-	-	-	
	T8430	1.2	█	165	0.30	1.5	█	90	0.27	1.5	█	135	0.30	1.5	█	450	0.36	1.5	█	35	0.21	1.2	-	-	-	
	T9325	1.2	█	200	0.30	1.5	█	120	0.27	1.5	█	190	0.30	1.5	█	-	-	-	█	45	0.21	1.2	-	-	-	

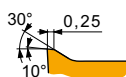

NM geometria con design altamente positivo per operazioni di finitura, media sgrossatura, taglio continuo.

DNMG 110404E-NM	T7325	0.4	█	175	0.20	0.8	█	135	0.18	0.8	█	-	-	-	█	55	0.20	0.6	█	-	-	-	-	-	
	T7335	0.4	█	165	0.20	0.8	█	125	0.18	0.8	█	-	-	-	█	50	0.20	0.6	█	-	-	-	-	-	
	T8315	0.4	█	160	0.20	0.8	█	95	0.18	0.8	█	-	-	-	█	480	0.24	0.8	█	40	0.20	0.6	-	-	-
	T8330	0.4	█	150	0.20	0.8	█	90	0.18	0.8	█	-	-	-	█	450	0.24	0.8	█	35	0.20	0.6	-	-	-
	T8430	0.4	█	175	0.20	0.8	█	95	0.18	0.8	█	-	-	-	█	480	0.24	0.8	█	35	0.20	0.6	-	-	-
	T9325	0.4	█	210	0.20	0.8	█	125	0.18	0.8	█	-	-	-	█	45	0.20	0.6	█	-	-	-	-	-	



Idoneità e valori iniziali per velocità di taglio (Vc), avanzamento (f) e profondità di taglio (ap). Fare riferimento alla nostra App Machining Calculator per ulteriori calcoli.

Codice prodotto	RE (mm)	P			M			K			N			S			H		
		vc (m/min)	f (mm/rev)	ap (mm)	vc (m/min)	f (mm/rev)	ap (mm)	vc (m/min)	f (mm/rev)	ap (mm)	vc (m/min)	f (mm/rev)	ap (mm)	vc (m/min)	f (mm/rev)	ap (mm)	vc (m/min)	f (mm/rev)	ap (mm)

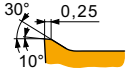

NM geometria con design altamente positivo per operazioni di finitura, media sgrassatura, taglio continuo.

DNMG 110408E-NM	T7325	0.8	190	0.25	0.8	145	0.23	0.8	-	-	-	-	-	-	60	0.20	0.6	-	-	-
	T7335	0.8	185	0.25	0.8	140	0.23	0.8	-	-	-	-	-	-	60	0.20	0.6	-	-	-
	T8315	0.8	180	0.25	0.8	105	0.23	0.8	-	-	-	540	0.30	0.8	45	0.20	0.6	-	-	-
	T8330	0.8	170	0.25	0.8	100	0.23	0.8	-	-	-	510	0.30	0.8	40	0.20	0.6	-	-	-
	T8430	0.8	190	0.25	0.8	105	0.23	0.8	-	-	-	525	0.30	0.8	40	0.20	0.6	-	-	-
	T9325	0.8	230	0.25	0.8	135	0.23	0.8	-	-	-	-	-	-	50	0.20	0.6	-	-	-
DNMG 150408E-NM	T7335	0.8	170	0.25	1.9	130	0.23	1.9	-	-	-	-	-	-	55	0.20	1.5	-	-	-
	T8330	0.8	155	0.25	1.9	90	0.23	1.9	-	-	-	465	0.30	1.9	35	0.20	1.5	-	-	-
	T8430	0.8	175	0.25	1.9	95	0.23	1.9	-	-	-	480	0.30	1.9	35	0.20	1.5	-	-	-
	T9325	0.8	210	0.25	1.9	125	0.23	1.9	-	-	-	-	-	-	45	0.20	1.5	-	-	-
DNMG 150604E-NM	T7325	0.4	160	0.20	1.9	120	0.18	1.9	-	-	-	-	-	-	50	0.20	1.5	-	-	-
	T7335	0.4	150	0.20	1.9	115	0.18	1.9	-	-	-	-	-	-	45	0.20	1.5	-	-	-
	T8315	0.4	150	0.20	1.9	90	0.18	1.9	-	-	-	450	0.24	1.9	35	0.20	1.5	-	-	-
	T8330	0.4	135	0.20	1.9	80	0.18	1.9	-	-	-	405	0.24	1.9	30	0.20	1.5	-	-	-
	T8430	0.4	155	0.20	1.9	85	0.18	1.9	-	-	-	435	0.24	1.9	30	0.20	1.5	-	-	-
	T9315	0.4	220	0.20	1.9	-	-	-	-	-	-	-	-	-	-	-	-	-	-	-
DNMG 150608E-NM	T9325	0.4	195	0.20	1.9	115	0.18	1.9	-	-	-	-	-	-	40	0.20	1.5	-	-	-
	T7325	0.8	175	0.25	1.9	135	0.23	1.9	-	-	-	-	-	-	55	0.20	1.5	-	-	-
	T7335	0.8	170	0.25	1.9	130	0.23	1.9	-	-	-	-	-	-	55	0.20	1.5	-	-	-
	T8315	0.8	165	0.25	1.9	95	0.23	1.9	-	-	-	495	0.30	1.9	40	0.20	1.5	-	-	-
	T8330	0.8	155	0.25	1.9	90	0.23	1.9	-	-	-	465	0.30	1.9	35	0.20	1.5	-	-	-
	T8430	0.8	175	0.25	1.9	95	0.23	1.9	-	-	-	480	0.30	1.9	35	0.20	1.5	-	-	-
DNMG 150612E-NM	T9315	0.8	235	0.25	1.9	-	-	-	-	-	-	-	-	-	-	-	-	-	-	-
	T9325	0.8	210	0.25	1.9	125	0.23	1.9	-	-	-	-	-	-	45	0.20	1.5	-	-	-
	T7325	1.2	175	0.30	1.9	135	0.27	1.9	-	-	-	-	-	-	55	0.24	1.5	-	-	-
	T7335	1.2	170	0.30	1.9	130	0.27	1.9	-	-	-	-	-	-	55	0.24	1.5	-	-	-
	T8315	1.2	165	0.30	1.9	95	0.27	1.9	-	-	-	495	0.36	1.9	40	0.24	1.5	-	-	-
	T9325	1.2	205	0.30	1.9	120	0.27	1.9	-	-	-	-	-	-	45	0.24	1.5	-	-	-

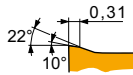

NMR geometria con design positivo per operazioni da media fino a sgrassatura, taglio continuo.

DNMG 110404E-NMR	T7325	0.4	150	0.20	0.8	115	0.18	0.8	-	-	-	-	-	-	45	0.18	0.6	-	-	-
	T9315	0.4	205	0.20	0.8	-	-	-	-	-	-	-	-	-	-	-	-	-	-	-
	T9325	0.4	185	0.20	0.8	110	0.18	0.8	-	-	-	-	-	-	40	0.18	0.6	-	-	-
DNMG 110408E-NMR	T7325	0.8	155	0.30	0.8	120	0.27	0.8	-	-	-	-	-	-	50	0.24	0.6	-	-	-
	T9315	0.8	205	0.30	0.8	-	-	-	-	-	-	-	-	-	-	-	-	-	-	-
	T9325	0.8	185	0.30	0.8	110	0.27	0.8	-	-	-	-	-	-	40	0.24	0.6	-	-	-
DNMG 110412E-NMR	T7325	1.2	155	0.30	1.6	120	0.27	1.6	-	-	-	-	-	-	50	0.24	1.3	-	-	-
	T9315	1.2	200	0.30	1.6	-	-	-	-	-	-	-	-	-	-	-	-	-	-	-
	T9325	1.2	180	0.30	1.6	105	0.27	1.6	-	-	-	-	-	-	40	0.24	1.3	-	-	-
DNMG 150404E-NMR	T7325	0.4	140	0.20	1.9	105	0.18	1.9	-	-	-	-	-	-	45	0.18	1.5	-	-	-
	T7335	0.4	130	0.20	1.9	100	0.18	1.9	-	-	-	-	-	-	40	0.18	1.5	-	-	-
	T9325	0.4	170	0.20	1.9	100	0.18	1.9	-	-	-	-	-	-	35	0.18	1.5	-	-	-
DNMG 150408E-NMR	T7325	0.8	145	0.30	1.9	110	0.27	1.9	-	-	-	-	-	-	45	0.24	1.5	-	-	-
	T7335	0.8	140	0.30	1.9	105	0.27	1.9	-	-	-	-	-	-	45	0.24	1.5	-	-	-
	T8330	0.8	125	0.30	1.9	75	0.27	1.9	-	-	-	-	-	-	30	0.24	1.5	-	-	-
	T8430	0.8	135	0.30	1.9	75	0.27	1.9	-	-	-	-	-	-	25	0.24	1.5	-	-	-
	T9315	0.8	190	0.30	1.9	-	-	-	-	-	-	-	-	-	-	-	-	-	-	-
	T9325	0.8	170	0.30	1.9	100	0.27	1.9	-	-	-	-	-	-	35	0.24	1.5	-	-	-
DNMG 150604E-NMR	T7325	0.4	140	0.20	1.9	105	0.18	1.9	-	-	-	-	-	-	45	0.18	1.5	-	-	-
	T7335	0.4	130	0.20	1.9	100	0.18	1.9	-	-	-	-	-	-	40	0.18	1.5	-	-	-
	T8330	0.4	120	0.20	1.9	70	0.18	1.9	-	-	-	-	-	-	30	0.18	1.5	-	-	-
	T8430	0.4	135	0.20	1.9	75	0.18	1.9	-	-	-	-	-	-	25	0.18	1.5	-	-	-
	T9315	0.4	190	0.20	1.9	-	-	-	-	-	-	-	-	-	-	-	-	-	-	-
	T9325	0.4	170	0.20	1.9	100	0.18	1.9	-	-	-	-	-	-	35	0.18	1.5	-	-	-



Idoneità e valori iniziali per velocità di taglio (V_c), avanzamento (f) e profondità di taglio (a_p). Fare riferimento alla nostra App Machining Calculator per ulteriori calcoli.

Codice prodotto	RE  (mm)	P			M			K			N			S			H		
		v_c (m/min)	f (mm/rev)	a_p (mm)	v_c (m/min)	f (mm/rev)	a_p (mm)	v_c (m/min)	f (mm/rev)	a_p (mm)	v_c (m/min)	f (mm/rev)	a_p (mm)	v_c (m/min)	f (mm/rev)	a_p (mm)	v_c (m/min)	f (mm/rev)	a_p (mm)

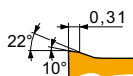

NMR geometria con design positivo per operazioni da media fino a sgrossatura, taglio continuo.

DNMG 150608E-NMR	T6310	0.8	█	125	0.30	1.9	█	90	0.27	1.9	█	-	-	-	█	35	0.24	1.5	-	-	-
	T7325	0.8	█	145	0.30	1.9	█	110	0.27	1.9	█	-	-	-	█	45	0.24	1.5	-	-	-
	T7335	0.8	█	140	0.30	1.9	█	105	0.27	1.9	█	-	-	-	█	45	0.24	1.5	-	-	-
	T8330	0.8	█	125	0.30	1.9	█	75	0.27	1.9	█	-	-	-	█	30	0.24	1.5	-	-	-
	T8430	0.8	█	135	0.30	1.9	█	75	0.27	1.9	█	-	-	-	█	25	0.24	1.5	-	-	-
	T9315	0.8	█	190	0.30	1.9	█	-	-	-	█	-	-	-	-	-	-	-	-	-	-
DNMG 150612E-NMR	T9325	0.8	█	170	0.30	1.9	█	100	0.27	1.9	█	-	-	-	█	35	0.24	1.5	-	-	-
	T7325	1.2	█	155	0.30	1.9	█	120	0.27	1.9	█	-	-	-	█	50	0.24	1.5	-	-	-
	T7335	1.2	█	145	0.30	1.9	█	110	0.27	1.9	█	-	-	-	█	45	0.24	1.5	-	-	-
	T8330	1.2	█	135	0.30	1.9	█	80	0.27	1.9	█	-	-	-	█	30	0.24	1.5	-	-	-
	T8430	1.2	█	145	0.30	1.9	█	80	0.27	1.9	█	-	-	-	█	30	0.24	1.5	-	-	-
	T9315	1.2	█	200	0.30	1.9	█	-	-	-	█	-	-	-	-	-	-	-	-	-	-
T9325	1.2	█	180	0.30	1.9	█	105	0.27	1.9	█	-	-	-	█	40	0.24	1.5	-	-	-	

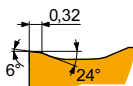

NRM geometria con design positivo per operazioni da semi sgrossatura fino a sgrossatura, da taglio continuo a moderatamente interrotto.

DNMG 150408-NRM	T7325	0.8	█	140	0.30	3.0	█	105	0.27	3.0	█	-	-	-	█	45	0.24	2.4	-	-	-
	T7335	0.8	█	130	0.30	3.0	█	100	0.27	3.0	█	-	-	-	█	40	0.24	2.4	-	-	-
	T9315	0.8	█	180	0.30	3.0	█	-	-	-	█	-	-	-	-	-	-	-	-	-	-
DNMG 150604-NRM	T7325	0.4	█	130	0.20	3.0	█	100	0.18	3.0	█	-	-	-	█	40	0.20	2.4	-	-	-
	T7335	0.4	█	130	0.20	3.0	█	100	0.18	3.0	█	-	-	-	█	40	0.20	2.4	-	-	-
	T9315	0.4	█	180	0.20	3.0	█	-	-	-	█	-	-	-	-	-	-	-	-	-	-
DNMG 150608-NRM	T7325	0.8	█	140	0.30	3.0	█	105	0.27	3.0	█	-	-	-	█	45	0.24	2.4	-	-	-
	T7335	0.8	█	130	0.30	3.0	█	100	0.27	3.0	█	-	-	-	█	40	0.24	2.4	-	-	-
	T9315	0.8	█	180	0.30	3.0	█	-	-	-	█	-	-	-	-	-	-	-	-	-	-
DNMG 150612-NRM	T7325	1.2	█	145	0.30	3.0	█	110	0.27	3.0	█	-	-	-	█	45	0.27	2.4	-	-	-
	T7335	1.2	█	140	0.30	3.0	█	105	0.27	3.0	█	-	-	-	█	45	0.27	2.4	-	-	-
	T9315	1.2	█	190	0.30	3.0	█	-	-	-	█	-	-	-	-	-	-	-	-	-	-

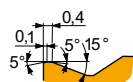
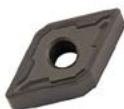

R geometria per operazioni da semi sgrossatura fino a sgrossatura, da taglio continuo a interrotto.

DNMG 150408E-R	T5315	0.8	█	175	0.40	3.0	█	-	-	-	█	165	0.40	3.0	█	-	-	-	█	35	0.15	1.0
DNMG 150608E-R	T5305	0.8	█	200	0.40	3.0	█	-	-	-	█	190	0.40	3.0	█	-	-	-	█	40	0.15	1.0
	T5315	0.8	█	175	0.40	3.0	█	-	-	-	█	165	0.40	3.0	█	-	-	-	█	35	0.15	1.0
	T9310	0.8	█	170	0.40	3.0	█	-	-	-	█	160	0.40	3.0	█	-	-	-	█	30	0.15	1.0
	T9315	0.8	█	155	0.40	3.0	█	-	-	-	█	145	0.40	3.0	█	-	-	-	█	30	0.15	1.0
	T9325	0.8	█	140	0.40	3.0	█	-	-	-	█	130	0.40	3.0	█	-	-	-	█	-	-	-
	T9310	0.8	█	170	0.40	3.0	█	-	-	-	█	170	0.40	3.0	█	-	-	-	█	35	0.15	1.0
DNMG 150612E-R	T5305	1.2	█	210	0.40	3.0	█	-	-	-	█	195	0.40	3.0	█	-	-	-	█	40	0.15	1.0
	T5315	1.2	█	185	0.40	3.0	█	-	-	-	█	175	0.40	3.0	█	-	-	-	█	35	0.15	1.0
	T9310	1.2	█	180	0.40	3.0	█	-	-	-	█	170	0.40	3.0	█	-	-	-	█	35	0.15	1.0
	T9315	1.2	█	165	0.40	3.0	█	-	-	-	█	155	0.40	3.0	█	-	-	-	█	30	0.15	1.0
DNMG 150616E-R	T9325	1.2	█	150	0.40	3.0	█	-	-	-	█	140	0.40	3.0	█	-	-	-	█	-	-	-
	T9325	1.6	█	155	0.40	3.0	█	-	-	-	█	145	0.40	3.0	█	-	-	-	█	-	-	-

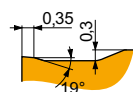

RM geometria per operazioni da semi sgrossatura fino a sgrossatura, da taglio continuo a interrotto.

DNMG 110408E-RM	T9315	0.8	█	190	0.40	2.0	█	-	-	-	█	180	0.40	2.0	█	-	-	-	█	-	-	-
	T9325	0.8	█	170	0.40	2.0	█	100	0.36	2.0	█	160	0.40	2.0	█	-	-	-	█	-	-	-
	T9335	0.8	█	145	0.40	2.0	█	85	0.36	2.0	█	-	-	-	█	-	-	-	█	-	-	-
DNMG 110412E-RM	T9315	1.2	█	230	0.30	2.0	█	-	-	-	█	215	0.30	2.0	█	-	-	-	█	-	-	-
	T9325	1.2	█	205	0.30	2.0	█	120	0.27	2.0	█	190	0.30	2.0	█	-	-	-	█	-	-	-



Idoneità e valori iniziali per velocità di taglio (Vc), avanzamento (f) e profondità di taglio (ap). Fare riferimento alla nostra App Machining Calculator per ulteriori calcoli.

Codice prodotto	RE  (mm)	P			M			K			N			S			H		
		vc (m/min)	f (mm/rev)	ap (mm)	vc (m/min)	f (mm/rev)	ap (mm)	vc (m/min)	f (mm/rev)	ap (mm)	vc (m/min)	f (mm/rev)	ap (mm)	vc (m/min)	f (mm/rev)	ap (mm)	vc (m/min)	f (mm/rev)	ap (mm)

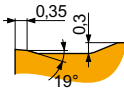

RM geometria per operazioni da semi sgrossatura fino a sgrossatura, da taglio continuo a interrotto.

DNMG 150408E-RM	T9315	0.8	180	0.40	3.0				170	0.40	3.0									
	T9325	0.8	165	0.40	3.0	95	0.36	3.0	155	0.40	3.0									
	T9335	0.8	140	0.40	3.0	80	0.36	3.0												
DNMG 150412E-RM	T7325	1.2	155	0.40	3.0	120	0.36	3.0												
	T9315	1.2	190	0.40	3.0				180	0.40	3.0									
	T9325	1.2	170	0.40	3.0	100	0.36	3.0	160	0.40	3.0									
DNMG 150608E-RM	T5305	0.8	230	0.40	3.0				215	0.40	3.0									
	T5315	0.8	205	0.40	3.0				190	0.40	3.0									
	T7325	0.8	145	0.40	3.0	110	0.36	3.0												
	T7335	0.8	135	0.40	3.0	105	0.36	3.0												
	T8315	0.8	135	0.40	3.0	80	0.36	3.0	125	0.40	3.0									
	T8330	0.8	130	0.40	3.0	75	0.36	3.0	120	0.40	3.0									
	T8430	0.8	135	0.40	3.0	75	0.36	3.0	110	0.40	3.0									
	T9310	0.8	200	0.40	3.0				190	0.40	3.0									
	T9315	0.8	180	0.40	3.0				170	0.40	3.0									
	T9325	0.8	165	0.40	3.0	95	0.36	3.0	155	0.40	3.0									
	T9335	0.8	140	0.40	3.0	80	0.36	3.0												
	DNMG 150612E-RM	T5305	1.2	240	0.40	3.0				225	0.40	3.0								
		T5315	1.2	215	0.40	3.0				200	0.40	3.0								
		T7325	1.2	155	0.40	3.0	120	0.36	3.0											
T7335		1.2	145	0.40	3.0	110	0.36	3.0												
T8330		1.2	135	0.40	3.0	80	0.36	3.0	125	0.40	3.0									
T8430		1.2	140	0.40	3.0	75	0.36	3.0	115	0.40	3.0									
T9310		1.2	210	0.40	3.0				195	0.40	3.0									
T9315		1.2	190	0.40	3.0				180	0.40	3.0									
T9325		1.2	170	0.40	3.0	100	0.36	3.0	160	0.40	3.0									
T9335		1.2	150	0.40	3.0	90	0.36	3.0												
DNMG 150616E-RM	T5315	1.6	225	0.40	3.0				210	0.40	3.0									
	T9315	1.6	200	0.40	3.0				190	0.40	3.0									
	T9325	1.6	180	0.40	3.0	105	0.36	3.0	170	0.40	3.0									
	T9335	1.6	155	0.40	3.0	90	0.36	3.0												

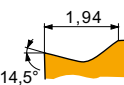

SF geometria con design positivo per operazioni di finitura su pareti sottili, taglio continuo.

DNMG 110404E-SF	T6310	0.4	150	0.15	0.8	105	0.14	0.8	120	0.15	0.8	450	0.18	0.8	45	0.12	0.6	30	0.15	1.0
	T7325	0.4	165	0.17	0.8	125	0.15	0.8							50	0.15	0.6			
	T8315	0.4	160	0.15	0.8	95	0.14	0.8	150	0.15	0.8	480	0.18	0.8	40	0.12	0.6	30	0.15	1.0
	T8430	0.4	180	0.15	0.8	95	0.14	0.8	145	0.15	0.8	495	0.18	0.8	35	0.12	0.6	30	0.15	1.0
	T9315	0.4	245	0.15	0.8				230	0.15	0.8							45	0.15	1.0
DNMG 110408E-SF	T9325	0.4	210	0.17	0.8	125	0.15	0.8	195	0.17	0.8				45	0.15	0.6			
	T6310	0.8	175	0.17	0.8	125	0.15	0.8	140	0.17	0.8	525	0.20	0.8	50	0.14	0.6	35	0.15	1.0
	T7325	0.8	195	0.17	0.8	150	0.15	0.8							60	0.15	0.6			
	T7335	0.8	195	0.17	0.8	150	0.15	0.8							60	0.15	0.6			
	T8315	0.8	180	0.17	0.8	105	0.15	0.8	170	0.17	0.8	540	0.20	0.8	45	0.14	0.6	35	0.15	1.0
	T8430	0.8	200	0.17	0.8	110	0.15	0.8	165	0.17	0.8	555	0.20	0.8	40	0.14	0.6	35	0.15	1.0
	T9325	0.8	250	0.17	0.8	150	0.15	0.8	235	0.17	0.8				55	0.15	0.6			
DNMG 150404E-SF	T6310	0.4	140	0.15	1.5	100	0.14	1.5	110	0.15	1.5	420	0.18	1.5	40	0.12	1.2	25	0.15	1.0
	T8315	0.4	150	0.15	1.5	90	0.14	1.5	140	0.15	1.5	450	0.18	1.5	35	0.12	1.2	30	0.15	1.0
	T8430	0.4	165	0.15	1.5	90	0.14	1.5	135	0.15	1.5	450	0.18	1.5	35	0.12	1.2	25	0.15	1.0
	T9325	0.4	195	0.17	1.5	115	0.15	1.5	185	0.17	1.5				40	0.15	1.2			



Idoneità e valori iniziali per velocità di taglio (Vc), avanzamento (f) e profondità di taglio (ap). Fare riferimento alla nostra App Machining Calculator per ulteriori calcoli.

Codice prodotto	RE  (mm)	P			M			K			N			S			H		
		vc (m/min)	f (mm/rev)	ap (mm)	vc (m/min)	f (mm/rev)	ap (mm)	vc (m/min)	f (mm/rev)	ap (mm)	vc (m/min)	f (mm/rev)	ap (mm)	vc (m/min)	f (mm/rev)	ap (mm)	vc (m/min)	f (mm/rev)	ap (mm)

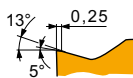

SM geometria con design positivo per medie lavorazioni, da taglio continuo a interrotto.

DNMG 150608E-SM	T6310	0.8	140	0.25	1.7	100	0.23	1.7	110	0.25	1.7	420	0.30	1.7	40	0.20	1.4	25	0.15	1.0
	T7325	0.8	160	0.25	1.7	120	0.23	1.7	-	-	-	-	-	-	50	0.20	1.4	-	-	-
	T7335	0.8	155	0.25	1.7	120	0.23	1.7	-	-	-	-	-	-	50	0.20	1.4	-	-	-
	T8330	0.8	140	0.25	1.7	80	0.23	1.7	130	0.25	1.7	420	0.30	1.7	35	0.20	1.4	25	0.15	1.0
	T8430	0.8	155	0.25	1.7	85	0.23	1.7	130	0.25	1.7	435	0.30	1.7	30	0.20	1.4	25	0.15	1.0
	T9315	0.8	215	0.25	1.7	-	-	-	200	0.25	1.7	-	-	-	-	-	-	40	0.15	1.0
DNMG 150612E-SM	T6310	1.2	145	0.30	1.7	100	0.27	1.7	115	0.30	1.7	435	0.36	1.7	40	0.24	1.4	25	0.15	1.0
	T7325	1.2	160	0.30	1.7	120	0.27	1.7	-	-	-	-	-	-	50	0.24	1.4	-	-	-
	T7335	1.2	155	0.30	1.7	120	0.27	1.7	-	-	-	-	-	-	50	0.24	1.4	-	-	-
	T8330	1.2	145	0.30	1.7	85	0.27	1.7	135	0.30	1.7	435	0.36	1.7	35	0.24	1.4	25	0.15	1.0
	T8430	1.2	155	0.30	1.7	85	0.27	1.7	130	0.30	1.7	435	0.36	1.7	30	0.24	1.4	25	0.15	1.0
	T9315	1.2	210	0.30	1.7	-	-	-	195	0.30	1.7	-	-	-	-	-	-	40	0.15	1.0
T9325	1.2	190	0.30	1.7	110	0.27	1.7	180	0.30	1.7	-	-	-	40	0.24	1.4	-	-	-	

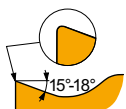

ER-SI geometria positiva destra per operazioni da finitura fino a semi sgrossatura, taglio continuo.

DNMG 110404ER-SI	T7325	0.4	185	0.20	1.0	140	0.18	1.0	-	-	-	-	-	60	0.18	0.8	-	-	-	
	T7335	0.4	180	0.20	1.0	140	0.18	1.0	-	-	-	-	-	55	0.18	0.8	-	-	-	
	T8330	0.4	160	0.20	1.0	95	0.18	1.0	-	-	-	480	0.24	1.0	40	0.18	0.8	-	-	-
	T8430	0.4	185	0.20	1.0	100	0.18	1.0	-	-	-	510	0.24	1.0	40	0.18	0.8	-	-	-
	T9325	0.4	225	0.20	1.0	135	0.18	1.0	-	-	-	-	-	-	50	0.18	0.8	-	-	-
DNMG 110408ER-SI	T7335	0.8	175	0.35	1.0	135	0.32	1.0	-	-	-	-	-	55	0.25	0.8	-	-	-	
	T8330	0.8	165	0.35	1.0	95	0.32	1.0	-	-	-	495	0.42	1.0	40	0.25	0.8	-	-	-
	T8430	0.8	180	0.35	1.0	95	0.32	1.0	-	-	-	495	0.42	1.0	35	0.25	0.8	-	-	-
	T9325	0.8	210	0.35	1.0	125	0.32	1.0	-	-	-	-	-	45	0.25	0.8	-	-	-	
DNMG 150404ER-SI	T8330	0.4	155	0.20	1.5	90	0.18	1.5	-	-	-	465	0.24	1.5	35	0.18	1.2	-	-	-
	T8430	0.4	175	0.20	1.5	95	0.18	1.5	-	-	-	480	0.24	1.5	35	0.18	1.2	-	-	-
	T9325	0.4	220	0.20	1.5	130	0.18	1.5	-	-	-	-	-	45	0.18	1.2	-	-	-	
DNMG 150408ER-SI	T8330	0.8	160	0.35	1.5	95	0.32	1.5	-	-	-	480	0.42	1.5	40	0.25	1.2	-	-	-
	T8430	0.8	170	0.35	1.5	90	0.32	1.5	-	-	-	465	0.42	1.5	35	0.25	1.2	-	-	-
	T9325	0.8	200	0.35	1.5	120	0.32	1.5	-	-	-	-	-	45	0.25	1.2	-	-	-	
DNMG 150604ER-SI	T7325	0.4	180	0.20	1.5	140	0.18	1.5	-	-	-	-	-	55	0.18	1.2	-	-	-	
	T7335	0.4	170	0.20	1.5	130	0.18	1.5	-	-	-	-	-	55	0.18	1.2	-	-	-	
	T8315	0.4	165	0.20	1.5	95	0.18	1.5	-	-	-	495	0.24	1.5	40	0.18	1.2	-	-	-
	T8330	0.4	155	0.20	1.5	90	0.18	1.5	-	-	-	465	0.24	1.5	35	0.18	1.2	-	-	-
	T8430	0.4	175	0.20	1.5	95	0.18	1.5	-	-	-	480	0.24	1.5	35	0.18	1.2	-	-	-
	T9325	0.4	220	0.20	1.5	130	0.18	1.5	-	-	-	-	-	45	0.18	1.2	-	-	-	
DNMG 150608ER-SI	T7325	0.8	180	0.35	1.5	140	0.32	1.5	-	-	-	-	-	55	0.25	1.2	-	-	-	
	T7335	0.8	170	0.35	1.5	130	0.32	1.5	-	-	-	-	-	55	0.25	1.2	-	-	-	
	T8315	0.8	165	0.35	1.5	95	0.32	1.5	-	-	-	495	0.42	1.5	40	0.25	1.2	-	-	-
	T8330	0.8	160	0.35	1.5	95	0.32	1.5	-	-	-	480	0.42	1.5	40	0.25	1.2	-	-	-
	T8430	0.8	170	0.35	1.5	90	0.32	1.5	-	-	-	465	0.42	1.5	35	0.25	1.2	-	-	-
	T9325	0.8	200	0.35	1.5	120	0.32	1.5	-	-	-	-	-	45	0.25	1.2	-	-	-	
T9335	0.8	180	0.35	1.5	105	0.32	1.5	-	-	-	-	-	40	0.25	1.2	-	-	-		

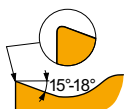

EL-SI geometria positiva sinistra per operazioni da finitura fino a semi sgrossatura, taglio continuo.

DNMG 110404EL-SI	T7335	0.4	180	0.20	1.0	140	0.18	1.0	-	-	-	-	-	55	0.18	0.8	-	-	-	
	T8330	0.4	160	0.20	1.0	95	0.18	1.0	-	-	-	480	0.24	1.0	40	0.18	0.8	-	-	-
	T8430	0.4	185	0.20	1.0	100	0.18	1.0	-	-	-	510	0.24	1.0	40	0.18	0.8	-	-	-
	T9325	0.4	225	0.20	1.0	135	0.18	1.0	-	-	-	-	-	50	0.18	0.8	-	-	-	



Idoneità e valori iniziali per velocità di taglio (Vc), avanzamento (f) e profondità di taglio (ap). Fare riferimento alla nostra App Machining Calculator per ulteriori calcoli.

Codice prodotto	RE (mm)	P			M			K			N			S			H		
		vc (m/min)	f (mm/rev)	ap (mm)	vc (m/min)	f (mm/rev)	ap (mm)	vc (m/min)	f (mm/rev)	ap (mm)	vc (m/min)	f (mm/rev)	ap (mm)	vc (m/min)	f (mm/rev)	ap (mm)	vc (m/min)	f (mm/rev)	ap (mm)

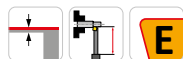
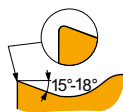

EL-SI geometria positiva sinistra per operazioni da finitura fino a semi sgrossatura, taglio continuo.

DNMG 110408EL-SI	T7325	0.8	185	0.35	1.0	140	0.32	1.0	-	-	-	495	0.42	1.0	60	0.25	0.8	-	-	-
	T8330	0.8	165	0.35	1.0	95	0.32	1.0	-	-	-	495	0.42	1.0	40	0.25	0.8	-	-	-
	T8430	0.8	180	0.35	1.0	95	0.32	1.0	-	-	-	495	0.42	1.0	35	0.25	0.8	-	-	-
	T9325	0.8	210	0.35	1.0	125	0.32	1.0	-	-	-	-	-	-	45	0.25	0.8	-	-	-
DNMG 150404EL-SI	T8330	0.4	155	0.20	1.5	90	0.18	1.5	-	-	-	465	0.24	1.5	35	0.18	1.2	-	-	-
	T8430	0.4	175	0.20	1.5	95	0.18	1.5	-	-	-	480	0.24	1.5	35	0.18	1.2	-	-	-
	T9325	0.4	220	0.20	1.5	130	0.18	1.5	-	-	-	-	-	-	45	0.18	1.2	-	-	-
DNMG 150408EL-SI	T7335	0.8	170	0.35	1.5	130	0.32	1.5	-	-	-	-	-	-	55	0.25	1.2	-	-	-
	T8330	0.8	160	0.35	1.5	95	0.32	1.5	-	-	-	480	0.42	1.5	40	0.25	1.2	-	-	-
	T8430	0.8	170	0.35	1.5	90	0.32	1.5	-	-	-	465	0.42	1.5	35	0.25	1.2	-	-	-
	T9325	0.8	200	0.35	1.5	120	0.32	1.5	-	-	-	-	-	-	45	0.25	1.2	-	-	-
DNMG 150604EL-SI	T7325	0.4	180	0.20	1.5	140	0.18	1.5	-	-	-	-	-	-	55	0.18	1.2	-	-	-
	T7335	0.4	170	0.20	1.5	130	0.18	1.5	-	-	-	-	-	-	55	0.18	1.2	-	-	-
	T8315	0.4	165	0.20	1.5	95	0.18	1.5	-	-	-	495	0.24	1.5	40	0.18	1.2	-	-	-
	T8330	0.4	155	0.20	1.5	90	0.18	1.5	-	-	-	465	0.24	1.5	35	0.18	1.2	-	-	-
	T8430	0.4	175	0.20	1.5	95	0.18	1.5	-	-	-	480	0.24	1.5	35	0.18	1.2	-	-	-
	T9325	0.4	220	0.20	1.5	130	0.18	1.5	-	-	-	-	-	-	45	0.18	1.2	-	-	-
DNMG 150608EL-SI	T7325	0.8	180	0.35	1.5	140	0.32	1.5	-	-	-	-	-	-	55	0.25	1.2	-	-	-
	T7335	0.8	170	0.35	1.5	130	0.32	1.5	-	-	-	-	-	-	55	0.25	1.2	-	-	-
	T8315	0.8	165	0.35	1.5	95	0.32	1.5	-	-	-	495	0.42	1.5	40	0.25	1.2	-	-	-
	T8330	0.8	160	0.35	1.5	95	0.32	1.5	-	-	-	480	0.42	1.5	40	0.25	1.2	-	-	-
	T8430	0.8	170	0.35	1.5	90	0.32	1.5	-	-	-	465	0.42	1.5	35	0.25	1.2	-	-	-
	T9325	0.8	200	0.35	1.5	120	0.32	1.5	-	-	-	-	-	-	45	0.25	1.2	-	-	-
T9335	0.8	180	0.35	1.5	105	0.32	1.5	-	-	-	-	-	-	40	0.25	1.2	-	-	-	

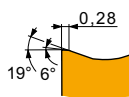

W-MR geometria wiper per operazioni da finitura fino a sgrossatura con maggiore velocità di avanzamento e finitura superficiale ottimizzata.

DNMG 150608W-MR	T5315	0.8	190	0.40	1.5	-	-	-	180	0.40	1.5	-	-	-	-	-	-	-	-	-
	T9315	0.8	170	0.40	1.5	-	-	-	160	0.40	1.5	-	-	-	-	-	-	-	-	-
	T9325	0.8	155	0.40	1.5	90	0.36	1.5	145	0.40	1.5	-	-	-	-	-	-	-	-	-
DNMG 150612W-MR	T9310	1.2	175	0.50	1.5	-	-	-	165	0.50	1.5	-	-	-	-	-	-	-	-	-
	T9315	1.2	160	0.50	1.5	-	-	-	150	0.50	1.5	-	-	-	-	-	-	-	-	-
	T9325	1.2	145	0.50	1.5	85	0.45	1.5	135	0.50	1.5	-	-	-	-	-	-	-	-	-

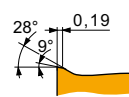

W-NM geometria wiper per operazioni da finitura fino a sgrossatura con maggiore velocità di avanzamento e finitura superficiale ottimizzata.

DNMX 150604W-NM	T7325	0.4	145	0.30	1.5	110	0.27	1.5	-	-	-	-	-	-	45	0.21	1.2	-	-	-
	T7335	0.4	135	0.30	1.5	105	0.27	1.5	-	-	-	-	-	-	40	0.21	1.2	-	-	-
	T9315	0.4	185	0.30	1.5	-	-	-	175	0.30	1.5	-	-	-	-	-	-	-	-	-
DNMX 150608W-NM	T7325	0.8	155	0.40	1.5	120	0.36	1.5	-	-	-	-	-	-	50	0.28	1.2	-	-	-
	T7335	0.8	145	0.40	1.5	110	0.36	1.5	-	-	-	-	-	-	45	0.28	1.2	-	-	-
	T9315	0.8	195	0.40	1.5	-	-	-	185	0.40	1.5	-	-	-	-	-	-	-	-	-
	T9325	0.8	175	0.40	1.5	105	0.36	1.5	165	0.40	1.5	-	-	-	35	0.28	1.2	-	-	-



DNMM

	IC	D1	L	S
	(mm)	(mm)	(mm)	(mm)
1504	12.700	5.16	15.50	4.76
1506	12.700	5.16	15.50	6.35

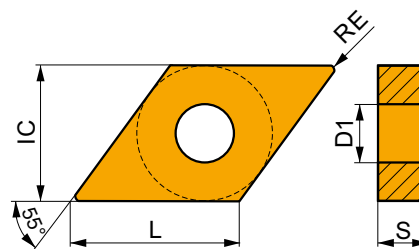

Idoneità e valori iniziali per velocità di taglio (Vc), avanzamento (f) e profondità di taglio (ap). Fare riferimento alla nostra App Machining Calculator per ulteriori calcoli.

Codice prodotto	RE	P			M			K			N			S			H		
		vc	f	ap	vc	f	ap	vc	f	ap	vc	f	ap	vc	f	ap	vc	f	ap
	(mm)	(m/min)	(mm/rev)	(mm)	(m/min)	(mm/rev)	(mm)	(m/min)	(mm/rev)	(mm)	(m/min)	(mm/rev)	(mm)	(m/min)	(mm/rev)	(mm)	(m/min)	(mm/rev)	(mm)

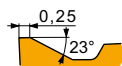

NR geometria per operazioni da semi sgrossatura fino a sgrossatura, da taglio continuo a interrotto.

DNMM 150408E-NR	T9325	0.8	█	155	0.40	3.0	█	90	0.36	3.0	█	145	0.40	3.0	–	–	–	█	30	0.28	2.4	–	–	–
DNMM 150608E-NR	T7325	0.8	█	140	0.40	3.0	█	105	0.36	3.0	–	–	–	–	–	–	–	█	45	0.28	2.4	–	–	–
	T8330	0.8	█	125	0.40	3.0	█	75	0.36	3.0	█	115	0.40	3.0	–	–	–	█	30	0.28	2.4	–	–	–
	T8430	0.8	█	130	0.40	3.0	█	70	0.36	3.0	█	105	0.40	3.0	–	–	–	█	25	0.28	2.4	–	–	–
	T9325	0.8	█	155	0.40	3.0	█	90	0.36	3.0	█	145	0.40	3.0	–	–	–	█	30	0.28	2.4	–	–	–

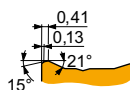

NR2 geometria per operazioni da semi sgrossatura fino a sgrossatura, da taglio continuo a interrotto.

DNMM 150608E-NR2	T9325	0.8	█	155	0.40	3.0	█	90	0.36	3.0	█	145	0.40	3.0	–	–	–	█	30	0.32	2.4	–	–	–
------------------	-------	-----	---	-----	------	-----	---	----	------	-----	---	-----	------	-----	---	---	---	---	----	------	-----	---	---	---

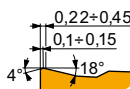

OR geometria per operazioni da semi sgrossatura fino a sgrossatura, da taglio continuo a interrotto.

DNMM 150608E-OR	T9325	0.8	█	155	0.40	3.0	█	90	0.36	3.0	█	145	0.40	3.0	–	–	–	█	30	0.28	2.4	–	–	–
DNMM 150612E-OR	T9315	1.2	█	180	0.40	3.0	–	–	–	–	█	170	0.40	3.0	–	–	–	–	–	–	–	–	–	–
	T9325	1.2	█	165	0.40	3.0	█	95	0.36	3.0	█	155	0.40	3.0	–	–	–	█	35	0.32	2.4	–	–	–
	T9335	1.2	█	145	0.40	3.0	█	85	0.36	3.0	–	–	–	–	–	–	–	█	30	0.32	2.4	–	–	–
DNMM 150616E-OR	T9325	1.6	█	165	0.45	3.0	█	95	0.41	3.0	█	155	0.45	3.0	–	–	–	█	35	0.41	2.4	–	–	–



DNGA CER

	IC (mm)	D1 (mm)	L (mm)	S (mm)
1504	12.700	5.16	15.50	4.76

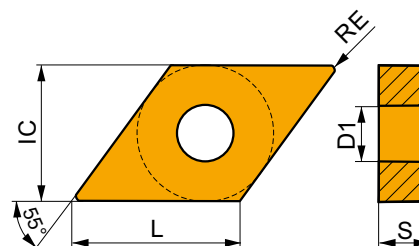

Idoneità e valori iniziali per velocità di taglio (Vc), avanzamento (f) e profondità di taglio (ap). Fare riferimento alla nostra App Machining Calculator per ulteriori calcoli.

Codice prodotto	RE (mm)	P			M			K			N			S			H		
		vc (m/min)	f (mm/rev)	ap (mm)	vc (m/min)	f (mm/rev)	ap (mm)	vc (m/min)	f (mm/rev)	ap (mm)	vc (m/min)	f (mm/rev)	ap (mm)	vc (m/min)	f (mm/rev)	ap (mm)			

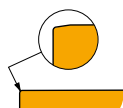

Adatta per lavorazioni con elevata velocità e taglio continuo.

DNGA 150408 S02020	TC100	0.8	-	-	-	-	-	-	450	0.20	1.5	-	-	-	-	-	-	-
--------------------	-------	-----	---	---	---	---	---	---	-----	------	-----	---	---	---	---	---	---	---

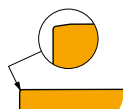

Adatta per lavorazioni con elevata velocità e taglio continuo.

DNGA 150404 T01020	TC100	0.4	-	-	-	-	-	-	475	0.10	1.5	-	-	-	-	-	-	-
DNGA 150408 T00520	TC100	0.8	-	-	-	-	-	-	450	0.20	1.5	-	-	-	-	-	-	-

DNGN CER

	IC (mm)	L (mm)	S (mm)
1504	12.700	15.50	4.76

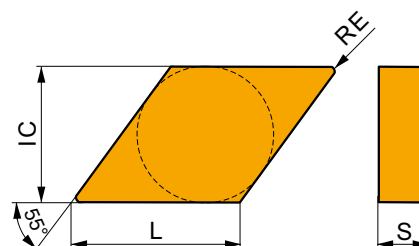

Idoneità e valori iniziali per velocità di taglio (Vc), avanzamento (f) e profondità di taglio (ap). Fare riferimento alla nostra App Machining Calculator per ulteriori calcoli.

Codice prodotto	RE (mm)	P			M			K			N			S			H		
		vc (m/min)	f (mm/rev)	ap (mm)	vc (m/min)	f (mm/rev)	ap (mm)	vc (m/min)	f (mm/rev)	ap (mm)	vc (m/min)	f (mm/rev)	ap (mm)	vc (m/min)	f (mm/rev)	ap (mm)			

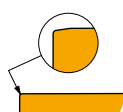
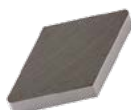

Adatta per lavorazioni con elevata velocità e taglio continuo.

DNGN 150408 T01020	TC100	0.8	-	-	-	-	-	-	450	0.20	1.5	-	-	-	-	-	-	-
--------------------	-------	-----	---	---	---	---	---	---	-----	------	-----	---	---	---	---	---	---	---



DNGA CBN

	IC	D1	L	S
	(mm)	(mm)	(mm)	(mm)
1506	12.700	5.16	15.50	6.35

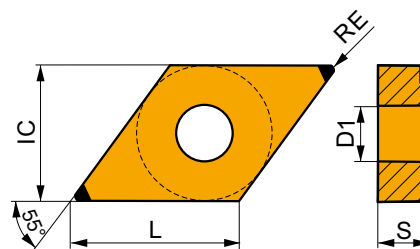

Idoneità e valori iniziali per velocità di taglio (V_c), avanzamento (f) e profondità di taglio (a_p). Fare riferimento alla nostra App Machining Calculator per ulteriori calcoli.

Codice prodotto	RE	P			M			K			N			S			H		
		v_c	f	a_p	v_c	f	a_p	v_c	f	a_p	v_c	f	a_p	v_c	f	a_p	v_c	f	a_p
	(mm)	(m/min)	(mm/rev)	(mm)	(m/min)	(mm/rev)	(mm)	(m/min)	(mm/rev)	(mm)	(m/min)	(mm/rev)	(mm)	(m/min)	(mm/rev)	(mm)	(m/min)	(mm/rev)	(mm)

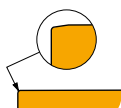

Adatta per operazioni di finitura e taglio continuo.

DNGA 150608S01020B	TB310	0.8	-	-	-	-	-	420	0.15	0.6	-	-	-	110	0.11	0.5	85	0.15	1.0
--------------------	-------	-----	---	---	---	---	---	-----	------	-----	---	---	---	-----	------	-----	----	------	-----



DDJN(RL) EXT



PRAMET

D



Utensile esterno, doppio bloccaggio, angolo del tagliente utensile 93°, inserti DN..

Utensile di tornitura esterno, destro / sinistro, doppio bloccaggio a staffa con angolo del tagliente utensile di 93°. Adatto per tornitura longitudinale con spallamento, copiatura, smussatura e sfacciatura con inserti DN.. negativi dimensioni 11 o 15. Disponibile con stelo da 20x20 fino a 32x32 mm. Corpo trattato per una maggiore durata dell'utensile.

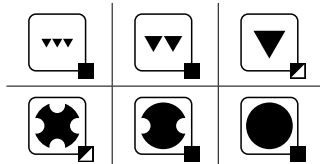
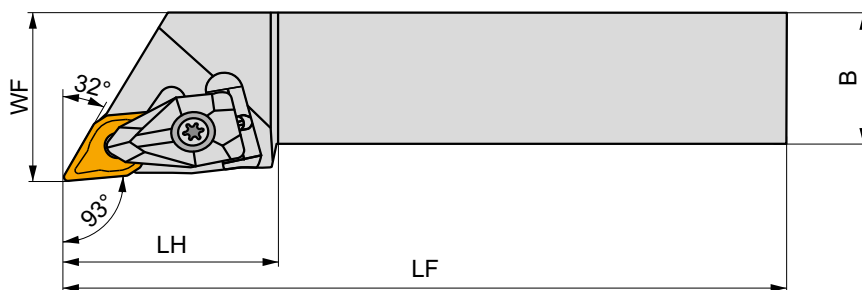
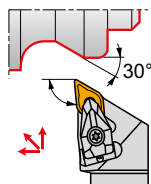

Codice prodotto	H	B	HF	WF	LF	LH	LAMS	GAMO	kg				
	(mm)	(mm)	(mm)	(mm)	(mm)	(mm)	(°)	(°)					
R	DDJNR 2020 K 11	20	20	20	25	125	30.2	-7	-6	0.45	GI046	DD11	-
	DDJNR 2525 M 11	25	25	25	32	150	30.2	-7	-6	0.77	GI046	DD11	-
	DDJNR 2020 K 15	20	20	20	25	125	39.4	-7	-6	0.42	GI044	DD154	AT002
	DDJNR 2525 M 15	25	25	25	32	150	39.4	-7	-6	0.74	GI044	DD154	AT002
	DDJNR 3225 P 15	32	25	32	32	170	39.4	-7	-6	1.12	GI044	DD154	AT002
	DDJNR 3232 P 15	32	32	32	40	170	39.4	-7	-6	1.33	GI044	DD154	AT002
L	DDJNL 2020 K 11	20	20	20	25	125	30.2	-7	-6	0.45	GI046	DD11	-
	DDJNL 2525 M 11	25	25	25	32	150	30.2	-7	-6	0.77	GI046	DD11	-
	DDJNL 2020 K 15	20	20	20	25	125	39.4	-7	-6	0.42	GI044	DD154	AT002
	DDJNL 2525 M 15	25	25	25	32	150	39.4	-7	-6	0.74	GI044	DD154	AT002
	DDJNL 3225 P 15	32	25	32	32	170	39.4	-7	-6	1.01	GI044	DD154	AT002
	DDJNL 3232 P 15	32	32	32	40	170	39.4	-7	-6	1.34	GI044	DD154	AT002



GI044

DN.. 1506..

GI046

DN.. 1104..



DD11

DCS 09

1.7

DDS 267-01

US 2004-T09P

FLAG T09P

DD154

DCS 12

3.9

DDS 266-02

US 2002-T15P

FLAG T15P/3,5



AT002a

DN.. 1504..

-

DDS 266-01

AT002b

CER DN.N 1506..

DCS 12C4

AT002c

CER DN.A 1506..

DCS 12C2

-



PDJN(RL) EXT



Utensile esterno, bloccaggio a leva, angolo del tagliente utensile 93°, inserti DN..

Utensile di tornitura esterno destro / sinistro, bloccaggio a leva con angolo del tagliente utensile di 93°. Adatto per tornitura longitudinale con spallamento, tornitura a copiare fino a 30° e smussatura con inserti DN.. negativi 11 e 15. Disponibile con dimensioni stelo da 20x20 fino a 32x32 mm. Corpo trattato per una maggiore durata dell'utensile.

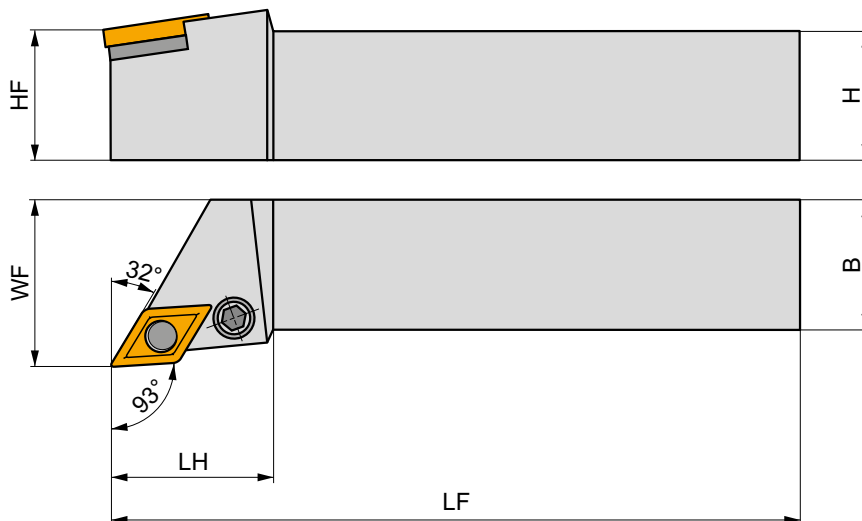
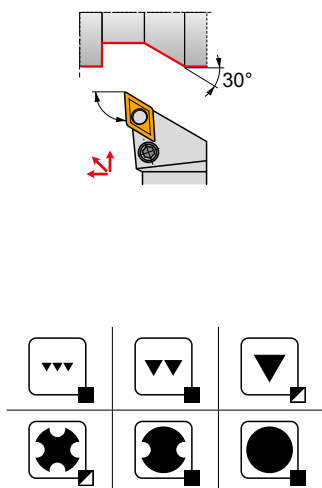

Codice prodotto	H	B	HF	WF	LF	LH	LAMS	GAMO	kg		
	(mm)	(mm)	(mm)	(mm)	(mm)	(mm)	(°)	(°)			
R PDJNR 2020 K 11	20	20	20	25	125	30	-6	-6	0.43	GI046	PD60
PDJNR 2525 M 11	25	25	25	32	150	30	-6	-6	0.73	GI046	PD60
PDJNR 3225 P 11	32	25	32	32	170	30	-6	-6	1.10	GI046	PD60
PDJNR 2020 K 15	20	20	20	25	125	40	-6	-6	0.44	GI044	PD31
PDJNR 2525 M 15	25	25	25	32	150	40	-6	-6	0.73	GI044	PD30
PDJNR 3225 P 15	32	25	32	32	170	40	-6	-6	1.05	GI044	PD30
PDJNR 3232 P 15	32	32	32	40	170	40	-6	-6	1.30	GI044	PD30
L PDJNL 2020 K 11	20	20	20	25	125	30	-6	-6	0.41	GI046	PD60
PDJNL 2525 M 11	25	25	25	32	150	30	-6	-6	0.73	GI046	PD60
PDJNL 3225 P 11	32	25	32	32	170	30	-6	-6	1.10	GI046	PD60
PDJNL 2020 K 15	20	20	20	25	125	40	-6	-6	0.42	GI044	PD31
PDJNL 2525 M 15	25	25	25	32	150	40	-6	-6	0.73	GI044	PD30
PDJNL 3225 P 15	32	25	32	32	170	40	-6	-6	0.98	GI044	PD30
PDJNL 3232 P 15	32	32	32	40	170	40	-6	-6	1.30	GI044	PD30

G1044		DN.. 1506..	
G1046		DN.. 1104..	

PD30	DNU 150308	PU 03	US 36	6.0	M 8x1	26	NT 05	MT 05	HXK 4
PD31	DNU 150308	PU 03	US 40	6.0	M 8x1	20.5	NT 05	MT 05	HXK 4
PD60	PDN 110308	PU 3512	PS 0616	3.0	M 6	16	NT 5153	MT 0912	HXK 2.5

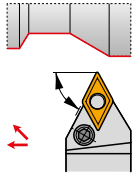

PDNN(RL) EXT

Utensile esterno, bloccaggio a leva, angolo del tagliente utensile 63°, inserti DN..

Utensile di tornitura esterno destro / sinistro, bloccaggio a leva, angolo del tagliente utensile 63°. Adatto per tornitura longitudinale senza spallamento, conicità, copiatura e tornitura di smussi con inserti DN.. 15 negativi. Disponibile con dimensioni stelo da 20x20 fino a 32x25 mm. Corpo trattato per una maggiore durata dell'utensile.

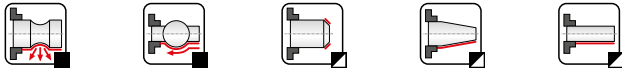
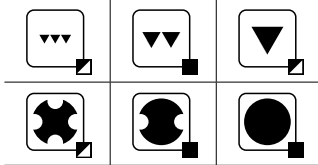
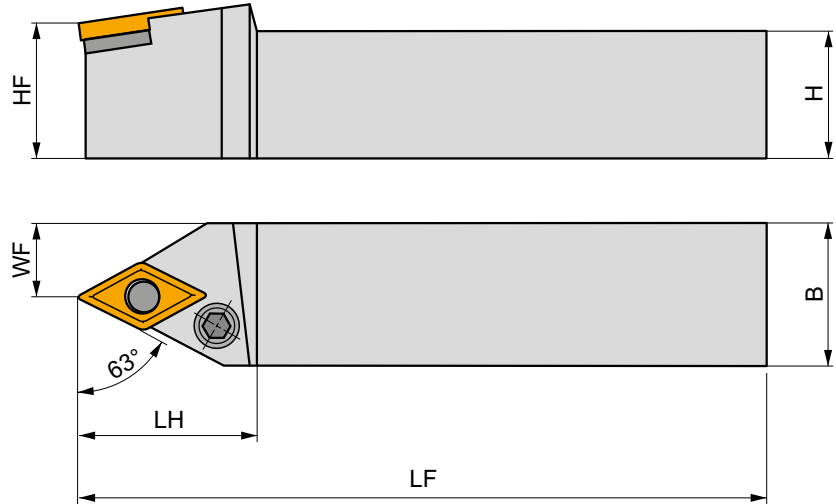

Codice prodotto	H	B	HF	WF	LF	LH	LAMS	GAMO	kg	GI046	GI044
	(mm)	(mm)	(mm)	(mm)	(mm)	(mm)	(°)	(°)			
R PDNNR 2020 K 11	20	20	20	10	125	24	-6	-6	0.39	GI046	PD60
PDNNR 2525 M 11	25	25	25	12.5	150	30	-6	-6	0.60	GI046	PD60
PDNNR 2525 M 15	25	25	25	12.5	150	40	-6	-6	0.64	GI044	PD30
PDNNR 3225 P 15	32	25	32	12.5	170	40	-6	-6	1.05	GI044	PD30
L PDNNL 2020 K 11	20	20	20	10	125	24	-6	-6	0.40	GI046	PD60
PDNNL 2525 M 11	25	25	25	12.5	150	30	-6	-6	0.60	GI046	PD60
PDNNL 2525 M 15	25	25	25	12.5	150	40	-6	-6	0.07	GI044	PD30
PDNNL 3225 P 15	32	25	32	12.5	170	40	-6	-6	1.05	GI044	PD30



GI044

DN.. 1506..

GI046

DN.. 1104..



PD30

DNU 150308

PU 03

US 36

6.0

M 8x1

26

NT 05

MT 05

HXK 4

PD60

PDN 110308

PU 3512

PS 0616

3.0

M 6

16

NT 5153

MT 0912

HXK 2.5



PDXN(RL) EXT



PRAMET

P



Utensile esterno, bloccaggio a leva, angolo del tagliente utensile 98°, inserti DN..

Utensile di tornitura esterno destro / sinistro, bloccaggio a leva con angolo del tagliente utensile di 98°. Adatto per conicità, tornitura longitudinale con spallamento, tornitura a copiare fino a 22° e smussatura con inserti DN..15. Disponibile con codoli da 20x20 a 32x25 mm. Corpo trattato per una maggiore durata dell'utensile.

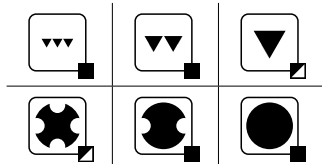
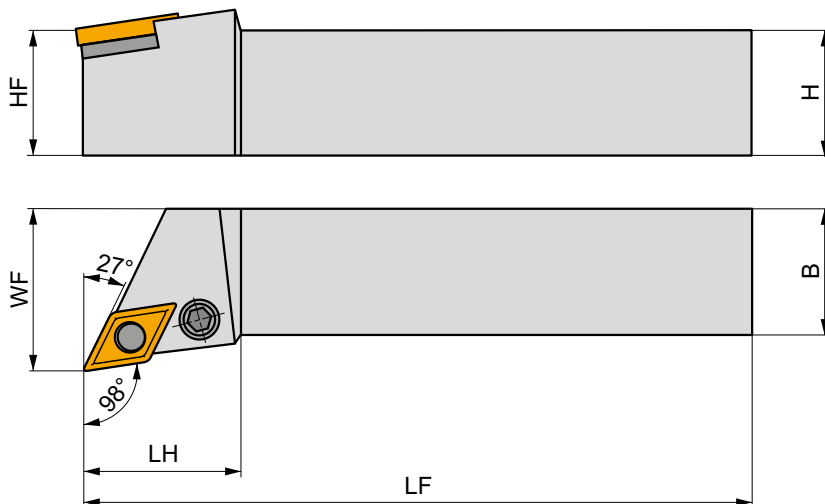
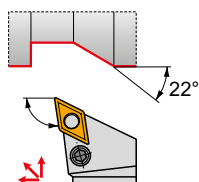

Codice prodotto	H	B	HF	WF	LF	LH	LAMS	GAMO	kg		
	(mm)	(mm)	(mm)	(mm)	(mm)	(mm)	(°)	(°)			
R PDXNR 2020 K 15	20	20	20	25	125	40	-6	-6	0.43	G1044	PD31
PDXNR 2525 M 15	25	25	25	32	150	40	-6	-6	0.73	G1044	PD30
PDXNR 3225 P 15	32	25	32	32	170	40	-6	-6	0.80	G1044	PD30
L PDXNL 2020 K 15	20	20	20	25	125	40	-6	-6	0.42	G1044	PD31
PDXNL 2525 M 15	25	25	25	32	150	40	-6	-6	0.71	G1044	PD30
PDXNL 3225 P 15	32	25	32	32	170	40	-6	-6	0.95	G1044	PD30



G1044



DN.. 1506..



PD30



DNU 150308



PU 03



US 36



6.0



M 8x1



26



NT 05



MT 05



HXK 4

PD31

DNU 150308

PU 03

US 40

6.0

M 8x1

20.5

NT 05

MT 05

HXK 4

NEW
C.-DDJN(RL) EXT

D

Utensile esterno PSC a cambio rapido, doppio bloccaggio, angolo di taglio 93°, per inserti DN..

Utensile di tornitura esterno destro / sinistro, doppio bloccaggio a staffa, fori interni per refrigerante, angolo del tagliente utensile di 93°. Per tornitura conica e longitudinale con spallamento, a copiare e smussare con inserti DN .. negativi 11 o 15. Attacco a cambio rapido PSC (Polygon Shank Coupling) da C4 a C6. Corpo trattato per una maggiore durata dell'utensile.

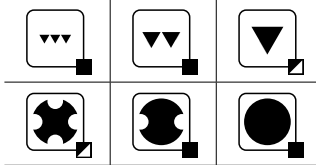
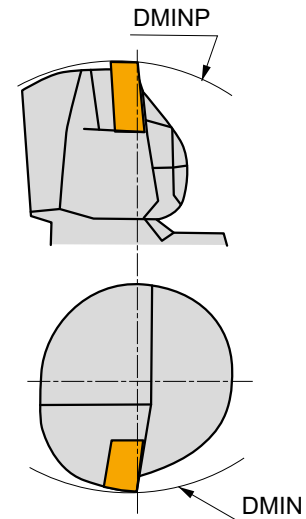
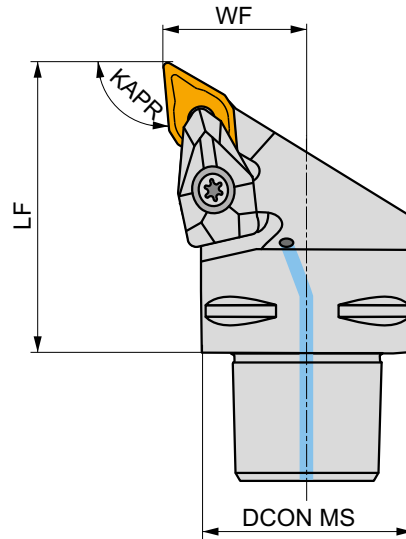
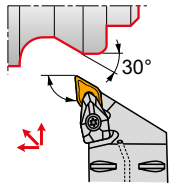

Codice prodotto	DCON MS	DMIN	DMINP	WF	LF	KAPR	LAMS	GAMO					
	(mm)	(mm)	(mm)	(mm)	(mm)	(°)	(°)	(°)					
R C4-DDJNR-27050-11	40	60	140	27	50	93	-7	-6	✓	0.38	GI046	C-DD11	-
C4-DDJNR-27055-15	40	110	145	27	55	93	-7	-6	✓	0.43	GI044	C-DD154-1	AT002
C5-DDJNR-35060-15	50	110	165	35	60	93	-7	-6	✓	0.72	GI044	C-DD154-2	AT002
C6-DDJNR-45065-15	63	110	190	45	65	93	-7	-6	✓	1.18	GI044	C-DD154-3	AT002
L C4-DDJNL-27050-11	40	60	140	27	50	93	-7	-6	✓	0.39	GI046	C-DD11	-
C4-DDJNL-27055-15	40	110	145	27	55	93	-7	-6	✓	0.43	GI044	C-DD154-1	AT002
C5-DDJNL-35060-15	50	110	165	35	60	93	-7	-6	✓	0.72	GI044	C-DD154-2	AT002
C6-DDJNL-45065-15	63	110	190	45	65	93	-7	-6	✓	1.18	GI044	C-DD154-3	AT002

 GI044
 GI046

 DN.. 1506..
 DN.. 1104..

C-DD11	DCS 09	1.7	DDS 267-01	US 2004-T09P	FLAG T09P	CN 034-01
C-DD154-1	DCS 12	3.9	DDS 266-02	US 2002-T15P	FLAG T15P/3,5	CN 034-01
C-DD154-2	DCS 12	3.9	DDS 266-02	US 2002-T15P	FLAG T15P/3,5	CN 045-01
C-DD154-3	DCS 12	3.9	DDS 266-02	US 2002-T15P	FLAG T15P/3,5	CN 034-02



AT002a	DN.. 1504..	-	DDS 266-01
AT002b	CER DN.N 1506..	DCS 12C4	-
AT002c	CER DN.A 1506..	DCS 12C2	-
AT002d	CER DN.N 1504..	DCS 12C4	DDS 266-01
AT002e	CER DN.A 1504..	DCS 12C2	DDS 266-01

NEW
C.-DDNNN EXT

D

Utensile esterno PSC a cambio rapido, doppio bloccaggio, angolo del tagliente ut. 62,5°, inserti DN..

Utensile di tornitura esterno, neutro, doppio bloccaggio a staffa e fori per refrigerante interno, con angolo del tagliente utensile di 62,5°. Per tornitura conica e longitudinale senza spallamento, copiatura e smussatura con inserti DN.. 15 negativi. Attacco a cambio rapido PSC (Polygon Shank Coupling) dim. C5 e C6. Corpo trattato per una maggiore durata dell'utensile.

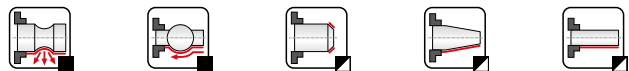
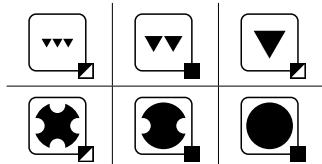
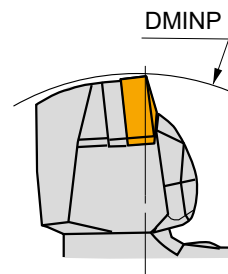
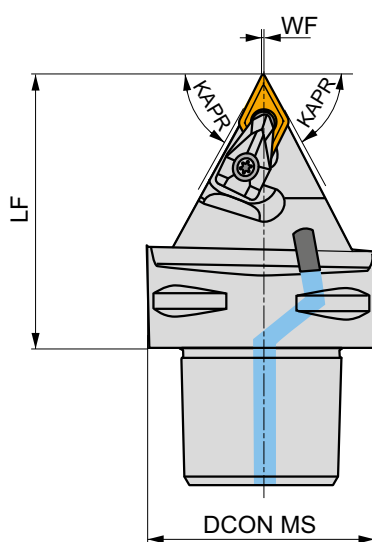
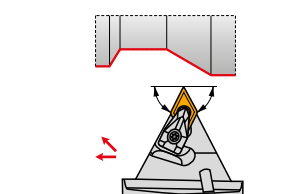

Codice prodotto	DCON MS (mm)	DMINP (mm)	WF (mm)	LF (mm)	KAPR (°)	LAMS (°)	GAMO (°)					
N C5-DDNNN-00060-15	50	165	0.5	60	62.5	-9	-5	✓	0.62	GI044	C-DD154-2	AT002
C6-DDNNN-00065-15	63	190	0.5	65	62.5	-9	-5	✓	1.06	GI044	C-DD154-2	AT002

GI044												DN.. 1506..

C-DD154-2	DCS 12	3.9	DDS 266-02	US 2002-T15P	FLAG T15P/3,5	CN 045-01						

AT002a	DN.. 1504..											DDS 266-01
AT002b	CER DN.N 1506..											
AT002c	CER DN.A 1506..											
AT002d	CER DN.N 1504..											DDS 266-01
AT002e	CER DN.A 1504..											DDS 266-01

NEW
C.-DDUN(RL) EXT

PRAMET
D

Utensile est. PSC a cambio rapido, doppio bloccaggio, angolo del tagliente 93°(sfacciare), inserti DN..

Utensile di tornitura esterno destro / sinistro, doppio bloccaggio a staffa, fori interni per refrigerante, angolo del tagliente utensile di 93 ° per sfacciatura con spallamento, copiatura, tornitura conica, tornitura longitudinale e smussatura con inserti DN.. negativi. Attacco a cambio rapido PSC (Polygon Shank Coupling) C5 e C6. Corpo trattato per una maggiore durata dell'utensile.

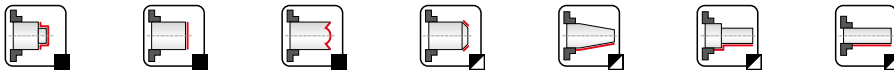
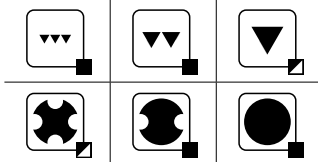
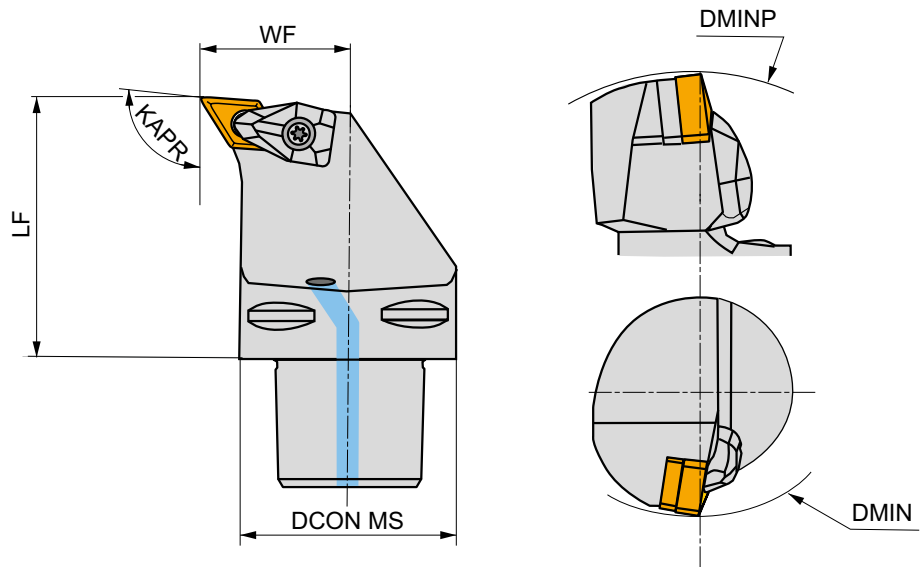
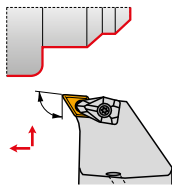

Codice prodotto	DCON MS	DMIN	DMINP	WF	LF	KAPR	LAMS	GAMO					
	(mm)	(mm)	(mm)	(mm)	(mm)	(°)	(°)	(°)					
R C5-DDUNR-35060-15	50	110	165	35	60	93	-7	-6	✓	0.82	GI044	C-DD154-3	AT002
C6-DDUNR-45065-15	63	110	190	45	65	93	-7	-6	✓	1.39	GI044	C-DD154-3	AT002
L C5-DDUNL-35060-15	50	110	165	35	60	93	-7	-6	✓	0.82	GI044	C-DD154-3	AT002



GI044



DN.. 1506..



C-DD154-3



DCS 12



3.9



DDS 266-02



US 2002-T15P



FLAG T15P/3,5



CN 034-02



AT002a



DN.. 1504..



DCS 12C4



DDS 266-01

AT002b

CER DN.N 1506..

DCS 12C2

AT002c

CER DN.A 1506..

DCS 12C2

AT002d

CER DN.N 1504..

DCS 12C4

AT002e

CER DN.A 1504..

DCS 12C2

DDS 266-01

DDS 266-01



DDUN(RL) INT



Utensile interno, doppio bloccaggio, per inserto DN... angolo del tagliente utensile 93°

Bareno destro/sinistro per tornitura interna con doppio bloccaggio a staffa e passaggio refrigerante interno, angolo del tagliente utensile 93° per inserti negativi DN...11 e 15. Diametro interno minimo tornibile Ø32 mm. Adatto per un'ampia gamma di operazioni di tornitura e copiatura fino a 27°. Disponibile con stelo da Ø25 mm a Ø50 mm. Corpo trattato per una maggiore durata.

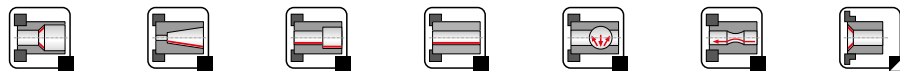
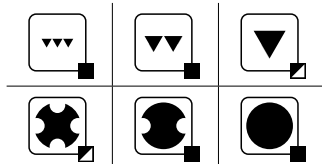
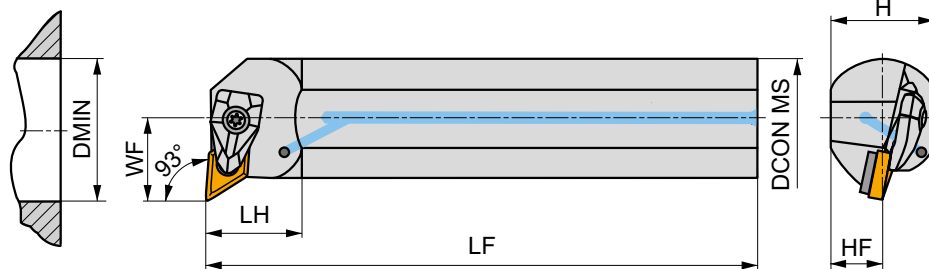
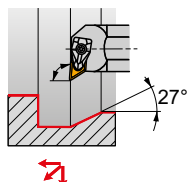

Codice prodotto	DCON MS (mm)	DMIN (mm)	WF (mm)	H (mm)	HF (mm)	LF (mm)	LH (mm)	LAMS (°)	GAMO (°)		kg			
R A25T-DDUNR 11	25	32	17	23	11.5	300	28	-12	-6	✓	0.96	GI046	DD11	-
A32T-DDUNR 11	32	40	22	30	15	300	30	-10	-6	✓	1.68	GI046	DD11	-
A40T-DDUNR 15	40	50	27	37	18.5	300	36	-11	-6	✓	2.59	GI044	DD154	AT002
A50U-DDUNR 15	50	63	35	47	23.5	350	39	-8	-6	✓	5.23	GI044	DD154	AT002
L A25T-DDUNL 11	25	32	17	23	11.5	300	28	-12	-6	✓	0.96	GI046	DD11	-
A32T-DDUNL 11	32	40	22	30	15	300	30	-10	-6	✓	1.69	GI046	DD11	-
A40T-DDUNL 15	40	50	27	37	18.5	300	36	-11	-6	✓	2.59	GI044	DD154	AT002
A50U-DDUNL 15	50	63	35	47	23.5	350	39	-8	-6	✓	5.25	GI044	DD154	AT002

GI044		DN.. 1506..
GI046		DN.. 1104..

DD11	DCS 09	1.7	DDS 267-01	US 2004-T09P	FLAG T09P
DD154	DCS 12	3.9	DDS 266-02	US 2002-T15P	FLAG T15P/3,5

AT002a	DN.. 1504..	-	DDS 266-01
AT002b	CER DN.N 1506..	DCS 12C4	-
AT002c	CER DN.A 1506..	DCS 12C2	-



PDUN(RL) INT



Utensile interno, bloccaggio a leva, inserti DN... angolo del tagliente utensile 93°

Bareno destro/sinistro per tornitura interna con bloccaggio a leva e passaggio refrigerante interno, angolo del tagliente utensile 93° per inserti negativi DN...11 e 15. Diametro interno minimo tornibile Ø32 mm. Adatto per un'ampia gamma di applicazioni di tornitura interna, copiatura fino a 27°. Disponibile con stelo da Ø25 mm fino a Ø60 mm. Corpo trattato per una maggiore durata.

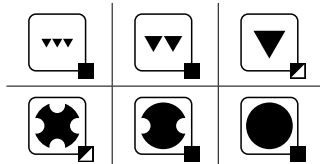
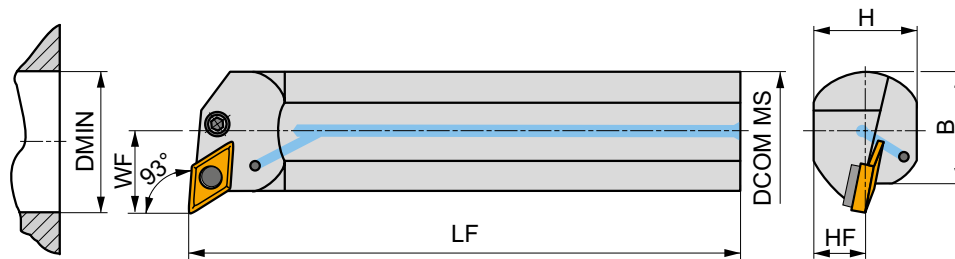
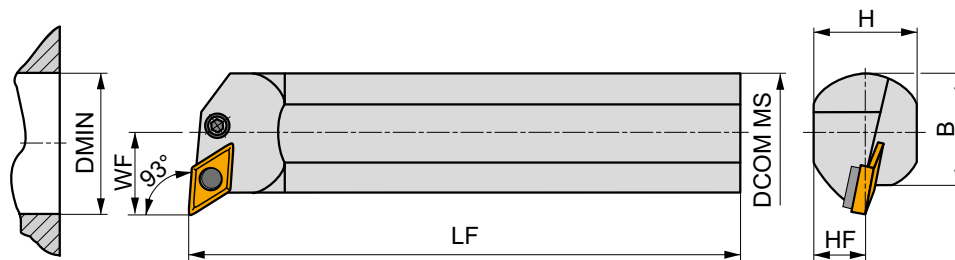
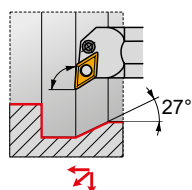

Codice prodotto	DCOM MS	DMIN	WF	H	B	LF	LAMS	GAMO					
	(mm)	(mm)	(mm)	(mm)	(mm)	(mm)	(°)	(°)					
R	S25T-PDUNR 11-A	25	32	17	23	23	300	-12	-6	-	1.10	GI046	PD61
	S32U-PDUNR 11	32	40	22	30	30	350	-12	-6	-	2.10	GI046	PD60
	A32S-PDUNR 15	32	40	32	30	30	250	-12	-6	✓	1.47	GI097	PD33
	A40T-PDUNR 15	40	50	27	38	38	300	-12	-6	✓	2.40	GI097	PD30
	A50U-PDUNR 15	50	63	35	47	48.5	350	-12	-6	✓	4.95	GI097	PD30
	A60V-PDUNR 15	60	80	43	57	58.5	400	-12	-6	✓	8.22	GI097	PD30
L	S25T-PDUNL 11-A	25	32	17	23	23	300	-12	-6	-	1.11	GI046	PD61
	S32U-PDUNL 11	32	40	22	30	30	350	-12	-6	-	2.09	GI046	PD60
	A32S-PDUNL 15	32	40	32	30	30	250	-12	-6	✓	1.47	GI097	PD33
	A40T-PDUNL 15	40	50	27	38	38	300	-12	-6	✓	2.56	GI097	PD30
	A50U-PDUNL 15	50	63	35	47	48.5	350	-12	-6	✓	5.20	GI097	PD30
	A60V-PDUNL 15	60	80	43	57	58.5	400	-12	-6	✓	8.16	GI097	PD30



GI046
GI097

DN.. 1104..
DN.. 1504..



PD30	DNU 150308	PU 03	US 36	6.0	M 8x1	26	NT 05	MT 05	HXX 4
PD33	-	PU 03-A	US 41	6.0	M 8x1	17	NT 15	MT 05	HXX 4
PD60	PDN 110308	PU 3512	PS 0616	3.0	M 6	16	NT 5153	MT 0912	HXX 2.5
PD61	-	PU 3611-A	PS 0512-A	2.0	M 5	12	-	-	HXX 2

NEW
C-DDUN(RL) INT

D

Utensile PSC interno a cambio rapido, doppio bloccaggio per inserto DN... angolo del tagliente ut. 93°

Utensile destro/sinistro per tornitura interna con doppio bloccaggio a staffa e passaggio refrigerante interno, angolo del tagliente utensile 93° per applicazioni di tornitura e copiatura interna fino a 27° con inserti negativi DN...11. Diametro interno minimo tornibile Ø32 mm. Attacco PSC (Attacco Poligonale) C4 con sporgenza di 68 mm. Corpo trattato per una maggiore durata.

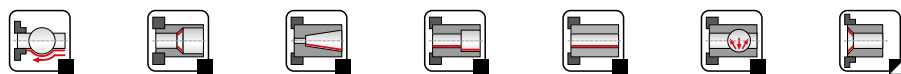
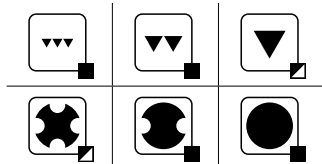
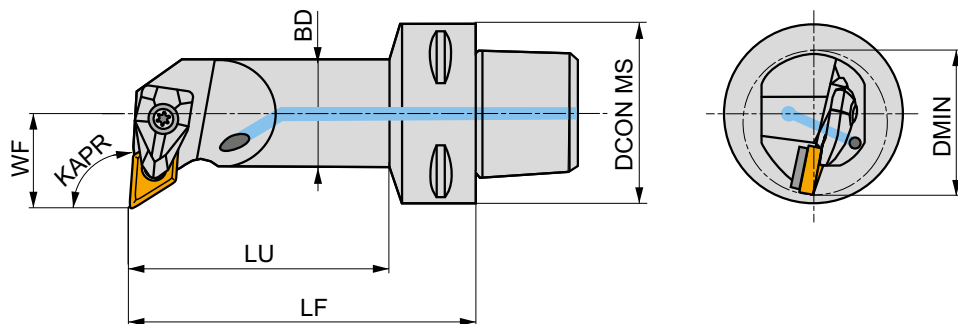
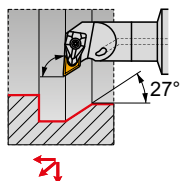

Codice prodotto	DCON MS (mm)	DMIN (mm)	WF (mm)	LF (mm)	LU (mm)	BD (mm)	KAPR (°)	LAMS (°)	GAMO (°)				
R C4-DDUNR-17090-11	40	32	17	90	68	25	93	-12	-6	✓	0.51	GI046	DD11
L C4-DDUNL-17090-11	40	32	17	90	68	25	93	-12	-6	✓	0.51	GI046	DD11



GI046



DN.. 1104..



DD11



DCS 09



1.7



DDS 267-01



US 2004-T09P



FLAG T09P



KN

16

INSERTI IN METALLO DURO

KNUX



284

ABBINAMENTO DELLA DIMENSIONE CORRETTA (esempio)

Inserto

KNUX 160405L-22

Portainsero

CKJNR 2020 K 16

TORNITURA ISO - ESTERNA

CKJN(RL) EXT

93°

KN..

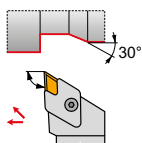

16

20×20
32×25

287

284 – 286



KNUX



	W1 (mm)	L (mm)	S (mm)
1604	9.525	19.50	4.76

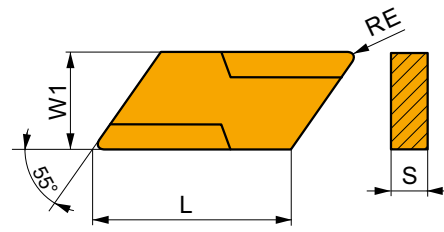

Idoneità e valori iniziali per velocità di taglio (Vc), avanzamento (f) e profondità di taglio (ap). Fare riferimento alla nostra App Machining Calculator per ulteriori calcoli.

Codice prodotto	RE (mm)	P			M			K			N			S			H		
		vc (m/min)	f (mm/rev)	ap (mm)	vc (m/min)	f (mm/rev)	ap (mm)	vc (m/min)	f (mm/rev)	ap (mm)	vc (m/min)	f (mm/rev)	ap (mm)	vc (m/min)	f (mm/rev)	ap (mm)	vc (m/min)	f (mm/rev)	ap (mm)

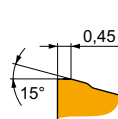

L-22 geometria sinistra, per operazioni da finitura fino a semi sgrossatura, taglio continuo.

KNUX 160405L-22	T5315	0.5	190	0.25	2.7	–	–	–	180	0.25	2.7	–	–	–	–	–	–	–	–
	T7325	0.5	130	0.25	2.7	100	0.25	2.7	–	–	–	–	–	–	–	–	–	–	–
	T7335	0.5	125	0.25	2.7	95	0.25	2.7	–	–	–	–	–	–	–	–	–	–	–
	T9325	0.5	155	0.25	2.7	90	0.25	2.7	145	0.25	2.7	–	–	–	–	–	–	–	–
	T9335	0.5	135	0.25	2.7	80	0.25	2.7	–	–	–	–	–	–	–	–	–	–	–

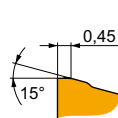

R-22 geometria destra per operazioni da finitura fino a semi sgrossatura, taglio continuo.

KNUX 160405R-22	T5315	0.5	190	0.25	2.7	–	–	–	180	0.25	2.7	–	–	–	–	–	–	–	–
	T7325	0.5	130	0.25	2.7	100	0.25	2.7	–	–	–	–	–	–	–	–	–	–	–
	T7335	0.5	125	0.25	2.7	95	0.25	2.7	–	–	–	–	–	–	–	–	–	–	–
	T9325	0.5	155	0.25	2.7	90	0.25	2.7	145	0.25	2.7	–	–	–	–	–	–	–	–
	T9335	0.5	135	0.25	2.7	80	0.25	2.7	–	–	–	–	–	–	–	–	–	–	–

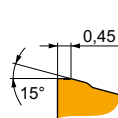

L-22 geometria sinistra, per operazioni da finitura fino a semi sgrossatura, taglio continuo.

KNUX 160410L-22	T9335	1.0	155	0.32	2.7	90	0.29	2.7	–	–	–	–	–	–	–	–	–	–	–
-----------------	-------	-----	-----	------	-----	----	------	-----	---	---	---	---	---	---	---	---	---	---	---

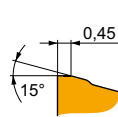

R-22 geometria destra per operazioni da finitura fino a semi sgrossatura, taglio continuo.

KNUX 160410R-22	T9335	1.0	155	0.32	2.7	90	0.29	2.7	–	–	–	–	–	–	–	–	–	–	–
-----------------	-------	-----	-----	------	-----	----	------	-----	---	---	---	---	---	---	---	---	---	---	---

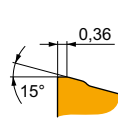











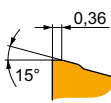



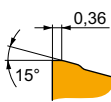



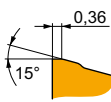



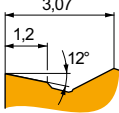



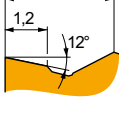



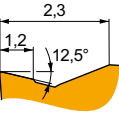

L-32 geometria sinistra, per operazioni da finitura fino a semi sgrossatura, taglio continuo.

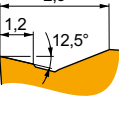
KNUX 160405L-32	T5315	0.5	190	0.25	2.7	–	–	–	180	0.25	2.7	–	–	–	–	–	–	–	–
	T7325	0.5	130	0.25	2.7	100	0.25	2.7	–	–	–	–	–	–	–	–	–	–	–
	T7335	0.5	125	0.25	2.7	95	0.25	2.7	–	–	–	–	–	–	–	–	–	–	–
	T9325	0.5	155	0.25	2.7	90	0.25	2.7	145	0.25	2.7	–	–	–	–	–	–	–	–
	T9335	0.5	135	0.25	2.7	80	0.25	2.7	–	–	–	–	–	–	–	–	–	–	–

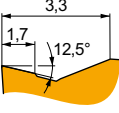

Idoneità e valori iniziali per velocità di taglio (Vc), avanzamento (f) e profondità di taglio (ap). Fare riferimento alla nostra App Machining Calculator per ulteriori calcoli.

Codice prodotto	RE (mm)	P			M			K			N			S			H				
		vc (m/min)	f (mm/rev)	ap (mm)	vc (m/min)	f (mm/rev)	ap (mm)	vc (m/min)	f (mm/rev)	ap (mm)	vc (m/min)	f (mm/rev)	ap (mm)	vc (m/min)	f (mm/rev)	ap (mm)	vc (m/min)	f (mm/rev)	ap (mm)		
		 	R-32 geometria destra per operazioni da finitura fino a semi sgrossatura, taglio continuo.																		
			KNUX 160405R-32	T5315	0.5	190	0.25	2.7	–	–	–	180	0.25	2.7	–	–	–	–	–	–	–
			T7325	0.5	130	0.25	2.7	100	0.25	2.7	–	–	–	–	–	–	–	–	–	–	–
			T7335	0.5	125	0.25	2.7	95	0.25	2.7	–	–	–	–	–	–	–	–	–	–	–
			T9325	0.5	155	0.25	2.7	90	0.25	2.7	145	0.25	2.7	–	–	–	–	–	–	–	–
T9335	0.5	135	0.25	2.7	80	0.25	2.7	–	–	–	–	–	–	–	–	–	–	–	–		
		 	L-32 geometria sinistra, per operazioni da finitura fino a semi sgrossatura, taglio continuo.																		
			KNUX 160410L-32	T9325	1.0	175	0.32	2.7	105	0.29	2.7	165	0.32	2.7	–	–	–	–	–	–	–
T9335	1.0	155	0.32	2.7	90	0.29	2.7	–	–	–	–	–	–	–	–	–	–	–	–		
		 	R-32 geometria destra per operazioni da finitura fino a semi sgrossatura, taglio continuo.																		
			KNUX 160410R-32	T9325	1.0	175	0.32	2.7	105	0.29	2.7	165	0.32	2.7	–	–	–	–	–	–	–
T9335	1.0	155	0.32	2.7	90	0.29	2.7	–	–	–	–	–	–	–	–	–	–	–	–		
		 	ER-72 geometria destra per lavorazioni leggere fino a finitura, taglio continuo.																		
			KNUX 160405ER-72	T5315	0.5	250	0.20	2.0	–	–	–	235	0.20	2.0	–	–	–	–	–	–	–
			T9325	0.5	215	0.20	2.0	125	0.18	2.0	200	0.20	2.0	–	–	–	45	0.16	1.6	–	–
T9335	0.5	185	0.20	2.0	110	0.18	2.0	–	–	–	–	–	–	40	0.16	1.6	–	–	–		
		 	EL-72 geometria sinistra per lavorazioni leggere fino a finitura, taglio continuo.																		
			KNUX 160405EL-72	T5315	0.5	250	0.20	2.0	–	–	–	235	0.20	2.0	–	–	–	–	–	–	–
			T9325	0.5	215	0.20	2.0	125	0.18	2.0	200	0.20	2.0	–	–	–	45	0.16	1.6	–	–
T9335	0.5	185	0.20	2.0	110	0.18	2.0	–	–	–	–	–	–	40	0.16	1.6	–	–	–		
		 	ER-73 geometria destra per operazioni da finitura fino a semi sgrossatura, taglio continuo.																		
			KNUX 160405SR-73	6640	0.5	150	0.25	3.0	90	0.23	3.0	140	0.25	3.0	–	–	–	–	–	–	–
			KNUX 160410SR-73	6640	1.0	150	0.40	3.0	90	0.36	3.0	140	0.40	3.0	–	–	–	–	–	–	–
T5315	1.0	235	0.40	3.0	–	–	–	220	0.40	3.0	–	–	–	–	–	–	–	–	–		
		 	EL-73 geometria sinistra per operazioni da finitura fino a semi sgrossatura, taglio continuo.																		
			KNUX 160405SL-73	6640	0.5	150	0.25	3.0	90	0.23	3.0	140	0.25	3.0	–	–	–	–	–	–	–
			KNUX 160410SL-73	6640	1.0	150	0.40	3.0	90	0.36	3.0	140	0.40	3.0	–	–	–	–	–	–	–
		 	ER-74 geometria destra per operazioni da finitura fino a sgrossatura, taglio continuo.																		
			KNUX 160415SR-74	6640	1.5	155	0.45	3.0	90	0.41	3.0	145	0.45	3.0	–	–	–	–	–	–	–



Idoneità e valori iniziali per velocità di taglio (V_c), avanzamento (f) e profondità di taglio (a_p). Fare riferimento alla nostra App Machining Calculator per ulteriori calcoli.

Codice prodotto	RE (mm)	P			M			K			N			S			H		
		v_c (m/min)	f (mm/rev)	a_p (mm)	v_c (m/min)	f (mm/rev)	a_p (mm)	v_c (m/min)	f (mm/rev)	a_p (mm)	v_c (m/min)	f (mm/rev)	a_p (mm)	v_c (m/min)	f (mm/rev)	a_p (mm)	v_c (m/min)	f (mm/rev)	a_p (mm)

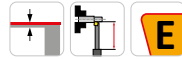
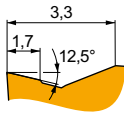

EL-74 geometria sinistra per operazioni da finitura fino a sgrossatura, taglio continuo.

KNUX 160415SL-74	6640	1.5	■	155	0.45	3.0	☑	90	0.41	3.0	■	145	0.45	3.0	—	—	—	—	—	—
-------------------------	-------------	-----	---	-----	------	-----	---	----	------	-----	---	-----	------	-----	---	---	---	---	---	---



CKJN(RL) EXT

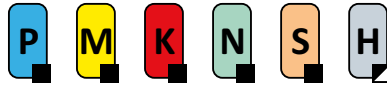

Utensile esterno, bloccaggio a staffa, inserti KN... angolo del tagliente utensile 93°

Utensile esterno destro/sinistro con bloccaggio a staffa, angolo del tagliente utensile 93° per inserto negativo KN...16. Adatto per operazioni di tornitura longitudinale con spallamento, copiatura fino a 30° e smussi. Disponibile con stelo da 20x20 a 32x25 mm. Corpo trattato per una maggiore durata.

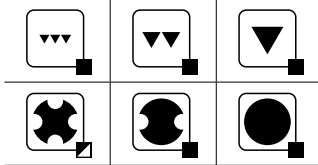
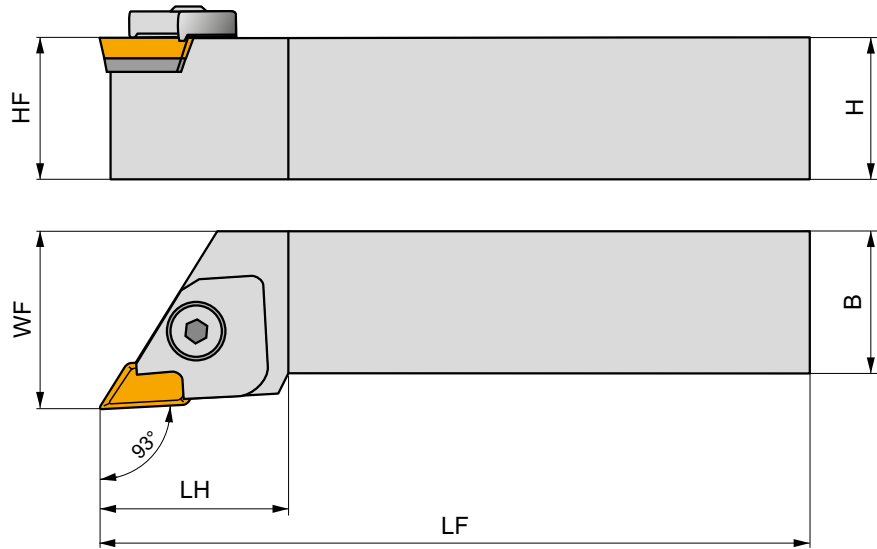
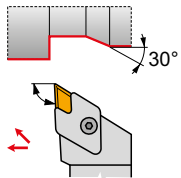

Codice prodotto	H	B	HF	WF	LF	LH	LAMS	GAMO	kg			
	(mm)	(mm)	(mm)	(mm)	(mm)	(mm)	(°)	(°)				
R	CKJNR 2020 K 16	20	20	20	30	125	34	1	-5	0.43	GI066	R1
	CKJNR 2525 M 16	25	25	25	32	150	34	1	-5	0.70	GI066	R
	CKJNR 3225 P 16	32	25	32	32	170	34	1	-5	1.05	GI066	R
L	CKJNL 2020 K 16	20	20	20	30	125	34	1	-5	0.43	GI067	L1
	CKJNL 2525 M 16	25	25	25	32	150	34	1	-5	0.74	GI067	L
	CKJNL 3225 P 16	32	25	32	32	170	34	1	-5	1.06	GI067	L



G1066

KN.X 1604...R

G1067

KN.X 1604...L



L

KNN 190412L

NT 03

-

UP 26

US 83

6.0

PR 07

K 23

HXK 4

L1

KNN 190412L

NT 03

-

UP 26

US 83

6.0

PR 07

K 22

HXK 4

R

KNN 190412R

NT 03

UP 25

-

US 83

6.0

PR 07

K 23

HXK 4

R1

KNN 190412R

NT 03

UP 25

-

US 83

6.0

PR 07

K 22

HXK 4



LN

40/ 50

INSERTI IN METALLO DURO

LNUX 40, LN.X 50

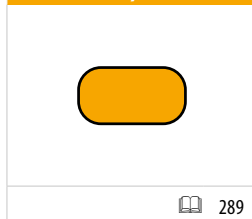

289

ABBINAMENTO DELLA DIMENSIONE CORRETTA (esempio)

Inserto	Portainserito
LNUX 40-1129003	KHP-LBNR 40-A

TORNITURA ISO - ESTERNA

PLBN(RL) EXT

75°	LN..
	 40 50
60x60	
290	289

TORNITURA ISO - SGROSSATURA PESANTE - ESTERNA

KHP-LBNR + DKH(RL)

75°	LN..
	 40
40x50 60x80	
291, 292	289

KHP-LBNL + DKH(RL)

75°	LN..
	 40
40x50 60x80	
291, 292	289







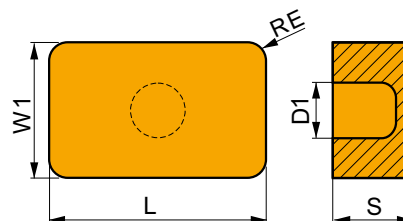



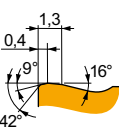

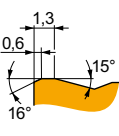
LNUX 40, LN.X 50

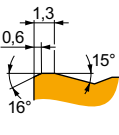
	W1 (mm)	D1 (mm)	L (mm)	S (mm)
40-1	25.200	9.30	40.00	14.00
50-1	25.400	9.30	50.80	14.00
50-2	25.400	6.45	50.80	14.00
5014	25.400	6.35	50.80	14.00

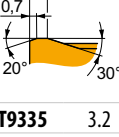

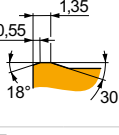
Idoneità e valori iniziali per velocità di taglio (Vc), avanzamento (f) e profondità di taglio (ap). Fare riferimento alla nostra App Machining Calculator per ulteriori calcoli.

Codice prodotto	RE (mm)	P			M			K			N			S			H					
		vc (m/min)	f (mm/rev)	ap (mm)	vc (m/min)	f (mm/rev)	ap (mm)	vc (m/min)	f (mm/rev)	ap (mm)	vc (m/min)	f (mm/rev)	ap (mm)	vc (m/min)	f (mm/rev)	ap (mm)	vc (m/min)	f (mm/rev)	ap (mm)			
 LNUX 40-1129002	 0.4, 1.3, 9°, 16°, 42°	 P	Adatta per operazioni di sgrossatura pesante, da taglio continuo a interrotto.																			
			T9226	3.2	45	1.35	25.0				40	1.35	25.0									
			T9325	3.2	55	1.35	25.0				50	1.35	25.0									
		T9335	3.2	40	1.35	25.0																
 LNUX 40-1129003	 0.6, 1.3, 15°, 16°	 P	Adatta per operazioni di sgrossatura pesante, da taglio continuo a interrotto.																			
			T9226	3.2	45	1.35	25.0				40	1.35	25.0									
			T9325	3.2	55	1.35	25.0				50	1.35	25.0									
		T9335	3.2	40	1.35	25.0																
 LNUX 50-1275000	 0.6, 1.3, 15°, 16°	 P	Adatta per operazioni di sgrossatura pesante, da taglio continuo a interrotto.																			
			T9226	3.2	45	1.35	25.0				40	1.35	25.0									
			T9325	3.2	55	1.35	25.0				50	1.35	25.0									
 LNMX 501432E	 0.7, 1.4, 20°, 30°	 P	Design adatto per operazioni di sgrossatura pesante, da taglio interrotto a fortemente interrotto.																			
			T9335	3.2	45	1.50	25.0															
 LNMX 50-2284000	 0.55, 1.35, 18°, 30°	 P	Adatta per operazioni di sgrossatura pesante, da taglio continuo a interrotto.																			
			T9315	3.2	60	1.50	25.0				55	1.50	25.0									



PLBN(RL) EXT



PRAMET

P



Utensile esterno per tornitura pesante, bloccaggio a leva, angolo del tagliente ut. 75°, inserti LNUX

Utensile di tornitura esterno destro / sinistro, bloccaggio a leva, con angolo del tagliente utensile di 75°. Per torniture pesanti. Adatto per tornitura longitudinale senza spallamento, tornitura conica e smussi con inserti negativi LN .. 40 e 50. Disponibile con stelo 60x60 mm. Corpo trattato per una maggiore durata dell'utensile.

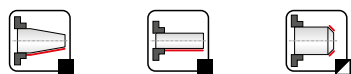
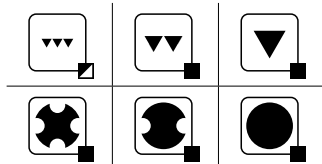
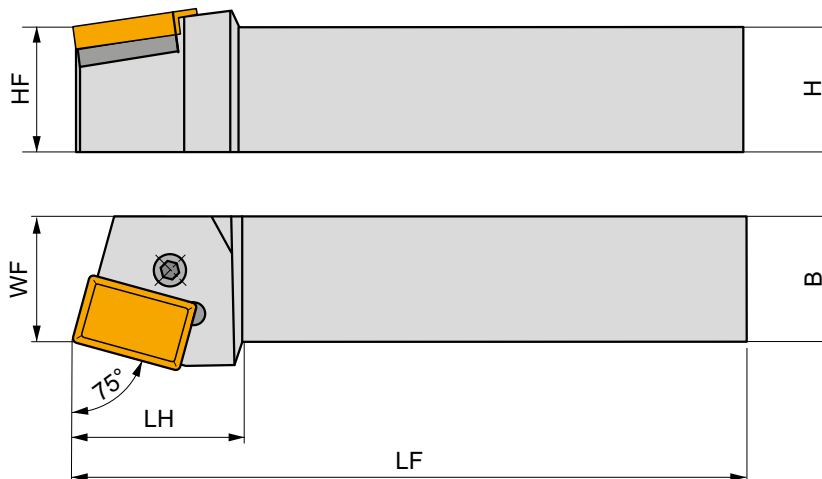
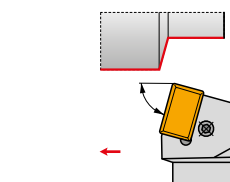

Codice prodotto	H	B	HF	WF	LF	LH	LAMS	GAMO	kg		
	(mm)	(mm)	(mm)	(mm)	(mm)	(mm)	(°)	(°)			
R PLBNR 6060 V 40-A	60	60	60	60	400	64	-6	-6	13.00	GI102	PL71
PLBNR 6060 V 50	60	60	60	60	400	70	-6	-6	12.75	GI145	PL72
PLBNR 6060 V 50-2	60	60	60	60	400	70	-6	-6	11.60	GI291	PL73
L PLBNL 6060 V 40-A	60	60	60	60	400	64	-6	-6	11.14	GI102	PL71
PLBNL 6060 V 50	60	60	60	60	400	70	-6	-6	13.09	GI145	PL72

GI102				LNUX 40....
GI145				LNUX 50....
GI291				LNMX 50....

PL71	LNX 400632	PU 06	PS 12040	8.0	M 12x1	40	NT 08	MT 08	HXK 5	-	-
PL72	LNX 500632	PU 06	PS 12040	8.0	M 12x1	40	NT 08	MT 08	HXK 5	-	-
PL73	LNX 500432P	-	-	-	-	-	-	-	-	UP 1515A-T15P	SDRT15P



KHP-LBN(RL)



Cartuccia di tornitura KHP, bloccaggio a leva, angolo del tagliente utensile 75°, inserti LNUX

Cartuccia a coda di rondine, destra/sinistra, bloccaggio a leva, angolo del tagliente utensile 75°, si monta su stelo utensili DKH. Adatta per tornitura longitudinale pesante senza spallamento, tornitura frontale, conica e smussi con inserti negativi LNUX 40. Utensile trattato per una maggiore durata.

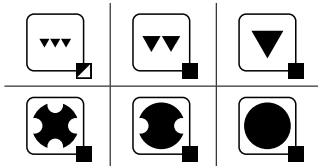
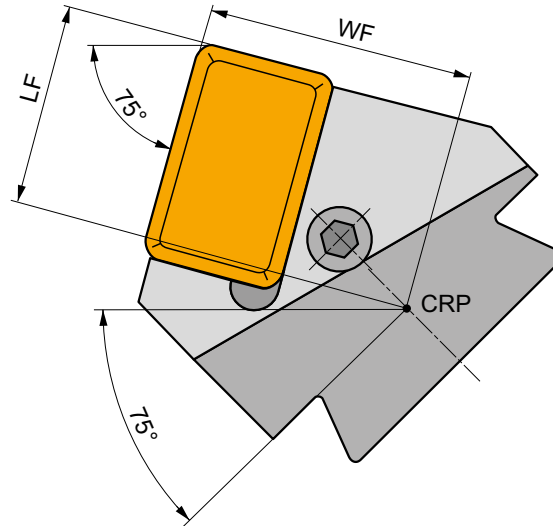
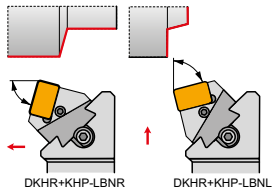

Codice prodotto	WF (mm)	LF (mm)	LAMS (°)	GAMO (°)	kg		
L KHP-LBNR 40-A	48	36	-6	-6	1.50	GI102	PL71
KHP-LBNL 40-A	48	36	-6	-6	1.47	GI102	PL71

	GI102		LNUX 40....
--	-------	--	-------------

PL71	LNX 400632	PU 06	PS 12040	8.0	M 12x1	40	NT 08	MT 08	HXK 5



DKH(RL)



Stelo esterno per cartucce modulari KHP/KHS per tornitura pesante

Stelo modulare, destro/sinistro, a coda di rondine per cartucce KHP/KHS. Adatto per applicazioni di tornitura pesante. Dimensioni stelo 40x50 fino a 60x80mm. Corpo trattato per una durata maggiore dell'utensile.

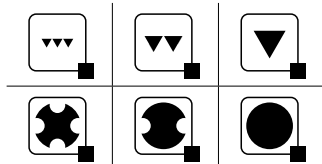
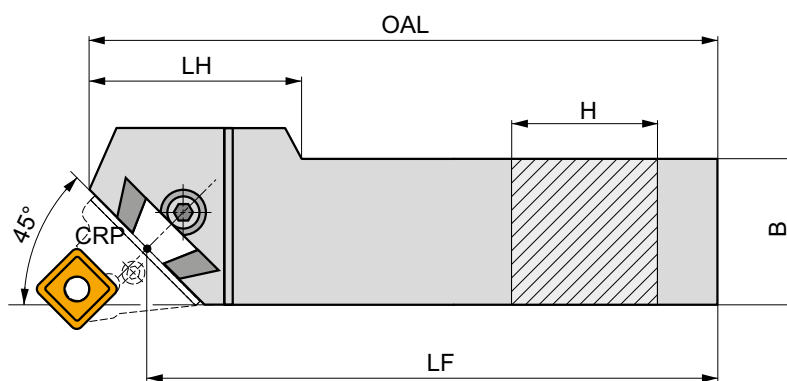
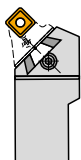

Codice prodotto	H	B	LF	OAL	LH	kg		
	(mm)	(mm)	(mm)	(mm)	(mm)			
R	DKHR 4050 V	40	50	400	425	7.10	GI098	DKH10
	DKHR 5060 W	50	60	450	475	11.30	GI098	DKH10
	DKHR 6080 W-A	60	80	450	485	19.65	GI098	DKH10
L	DKHL 4050 V	40	50	400	425	7.10	GI098	DKH10
	DKHL 5060 W	50	60	450	475	11.30	GI098	DKH10
	DKHL 6080 W-A	60	80	450	485	19.28	GI098	DKH10

GI098	KHP	KHS

DKH10	SR 14	HXK 10



RN

09/ 12/ 15/ 19/ 25

INSERTI IN METALLO DURO

RNMG



294

INSERTI CER

RNGN CER

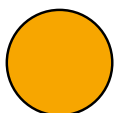

294

ABBINAMENTO DELLA DIMENSIONE CORRETTA (esempio)

Inserto

RNMG 120400E-08

Portainsero

DRSNR 2525 M 12

TORNITURA ISO - ESTERNA

DRSN(RL) EXT

RN..



12

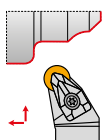

25x25

295

294

PRSN(RL) EXT

RN..



12

15

19

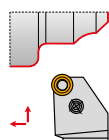

25x25
40x40

296

294

C.-DRSN(RL) EXT **NEW**

RN..



12

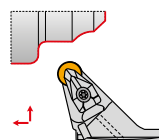

C6

297

294



RNMG



	INSD (mm)	D1 (mm)	S (mm)
1204	12.700	5.16	4.76
1506	15.875	6.35	6.35
1906	19.050	7.94	6.35
2509	25.400	9.12	9.53

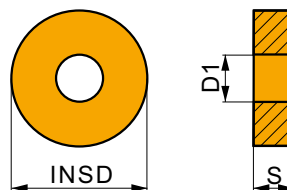

Idoneità e valori iniziali per velocità di taglio (Vc), avanzamento (f) e profondità di taglio (ap). Fare riferimento alla nostra App Machining Calculator per ulteriori calcoli.

Codice prodotto	RE	P			M			K			N			S			H		
		vc (m/min)	f (mm/rev)	ap (mm)	vc (m/min)	f (mm/rev)	ap (mm)	vc (m/min)	f (mm/rev)	ap (mm)	vc (m/min)	f (mm/rev)	ap (mm)	vc (m/min)	f (mm/rev)	ap (mm)	vc (m/min)	f (mm/rev)	ap (mm)

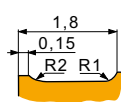

08 geometria per operazioni da semi sgrassatura fino a sgrassatura pesante, da taglio continuo a interrotto.

RNMG 120400E-08	T5305	–	✓	195	0.70	3.0	–	–	–	✓	185	0.70	3.0	–	–	–	–	–	–	✓	35	0.15	1.0	
	T9315	–	✓	150	0.70	3.0	–	–	–	✓	140	0.70	3.0	–	–	–	–	–	–	✓	30	0.15	1.0	
	T9325	–	✓	135	0.70	3.0	–	–	–	✓	125	0.70	3.0	–	–	–	–	–	–	–	–	–	–	
RNMG 150600E-08	T5305	–	✓	295	0.70	3.0	–	–	–	✓	280	0.70	3.0	–	–	–	–	–	–	–	✓	55	0.15	1.0
	T9315	–	✓	225	0.70	3.0	–	–	–	✓	210	0.70	3.0	–	–	–	–	–	–	–	✓	45	0.15	1.0
	T9325	–	✓	205	0.70	3.0	–	–	–	✓	190	0.70	3.0	–	–	–	–	–	–	–	–	–	–	
RNMG 190600E-08	T9315	–	✓	150	0.70	3.0	–	–	–	✓	140	0.70	3.0	–	–	–	–	–	–	–	✓	30	0.15	1.0
	T9325	–	✓	135	0.70	3.0	–	–	–	✓	125	0.70	3.0	–	–	–	–	–	–	–	–	–	–	

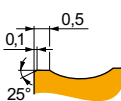

081 geometria per operazioni da sgrassatura fino a sgrassatura pesante, da taglio continuo a interrotto.

RNMG 250900E-081	T9315	–	✓	145	0.90	5.0	–	–	–	✓	135	0.90	5.0	–	–	–	–	–	–	–	✓	25	0.15	1.0
	T9325	–	✓	130	0.90	5.0	–	–	–	✓	120	0.90	5.0	–	–	–	–	–	–	–	–	–	–	

RNGN CER



	INSD (mm)	S (mm)
0903	9.525	3.18
1204	12.700	4.76
1207	12.700	7.94

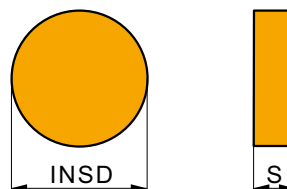

Idoneità e valori iniziali per velocità di taglio (Vc), avanzamento (f) e profondità di taglio (ap). Fare riferimento alla nostra App Machining Calculator per ulteriori calcoli.

Codice prodotto	RE	P			M			K			N			S			H		
		vc (m/min)	f (mm/rev)	ap (mm)	vc (m/min)	f (mm/rev)	ap (mm)	vc (m/min)	f (mm/rev)	ap (mm)	vc (m/min)	f (mm/rev)	ap (mm)	vc (m/min)	f (mm/rev)	ap (mm)	vc (m/min)	f (mm/rev)	ap (mm)

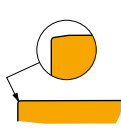
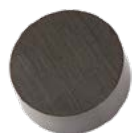

Adatta per lavorazioni con elevata velocità e taglio continuo.

RNGN 090300 T01020	TC100	–	–	–	–	–	–	–	–	–	–	–	–	–	–	–	–	–	–	–	–	–	–
RNGN 120400 T01020	TC100	–	–	–	–	–	–	–	–	–	–	–	–	–	–	–	–	–	–	–	–	–	–
RNGN 120700 T01020	TC100	–	–	–	–	–	–	–	–	–	–	–	–	–	–	–	–	–	–	–	–	–	–
RNGN 120700 T15015	TC100	–	–	–	–	–	–	–	–	–	–	–	–	–	–	–	–	–	–	–	–	–	–



DRSN(RL) EXT

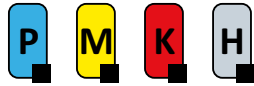

Utensile esterno, doppio bloccaggio, per inserti RN..

Utensile di tornitura esterno destro / sinistro, doppio bloccaggio a staffa. Adatto per tornitura longitudinale senza spallamento, tornitura a copiare, tornitura conica e smussatura con inserti tondi negativi RN .. 12. Disponibile con stelo 25x25 mm. Corpo trattato per una maggiore durata dell'utensile.

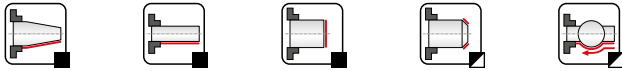
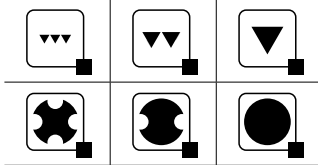
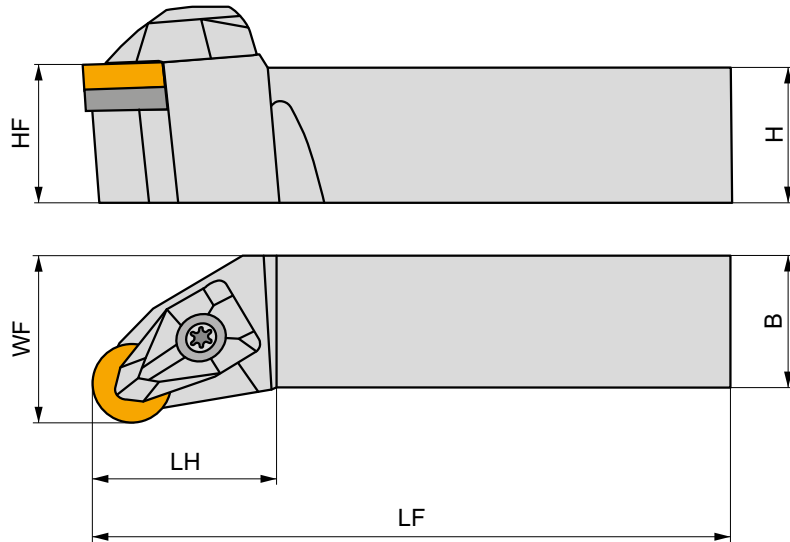
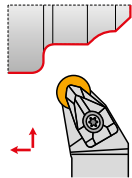

Codice prodotto	H (mm)	B (mm)	HF (mm)	WF (mm)	LF (mm)	LH (mm)	LAMS (°)	GAMO (°)	kg	GI083	DR12
R DRSNR 2525 M 12	25	25	25	32	150	31.6	-6	-6	0.74	GI083	DR12
L DRSNL 2525 M 12	25	25	25	32	150	31.6	-6	-6	0.75	GI083	DR12



GI083



RN.. 120400



DR12



DCS 12



3.9



DRS 155-02



US 2002-T15P



FLAG T15P/3,5



PRSN(RL) EXT



PRAMET

P



Utensile esterno, bloccaggio a leva, per inserti tondi RN..

Utensile di tornitura esterno destro / sinistro, bloccaggio a leva. Adatto per tornitura longitudinale, tornitura a copiare fino a 90°, tornitura conica e smussi, con inserti tondi negativi RN .. 12, 15 e 19. Disponibile con steli da 25x25 a 40x40 mm. Corpo trattato per una maggiore durata dell'utensile.

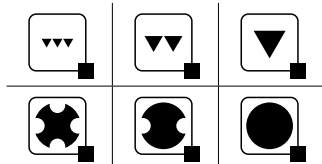
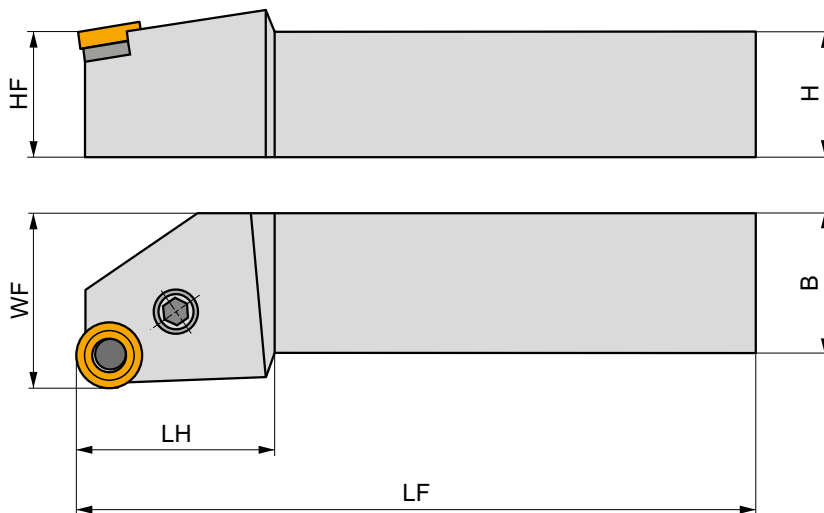
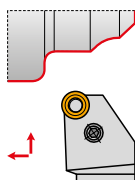

Codice prodotto	H	B	HF	WF	LF	LH	LAMS	GAMO	kg		
	(mm)	(mm)	(mm)	(mm)	(mm)	(mm)	(°)	(°)			
R PRSNR 2525 M 12	25	25	25	32	150	32	-6	-6	0.68	GI083	PR20
PRSNR 3232 P 15	32	32	32	40	170	38	-6	-6	1.40	GI105	PR40
PRSNR 4040 R 19	40	40	40	50	200	40	-6	-6	2.49	GI106	PR50
L PRSNL 2525 M 12	25	25	25	32	150	32	-6	-6	0.74	GI083	PR20
PRSNL 3232 P 15	32	32	32	40	170	38	-6	-6	1.40	GI105	PR40
PRSNL 4040 R 19	40	40	40	50	200	40	-6	-6	2.48	GI106	PR50

GI083	RN.. 120400
GI105	RN.. 150600
GI106	RN.. 190600

PR20	RNU 120300	PU 02	US 35	6.0	M 8x1	22.5	NT 05	MT 05	HXK 4
PR40	RNU 150300	PU 04	US 36	6.0	M 8x1	26	NT 07	MT 07	HXK 4
PR50	RNU 190400	PU 05	US 38	8.0	M 10x1	29	NT 06	MT 06	HXK 5

NEW
C.-DRSN(RL) EXT

PRAMET
D

Utensile esterno PSC a cambio rapido, doppio bloccaggio, per inserti RN..

Utensile di tornitura esterno destro / sinistro, doppio bloccaggio a staffa con fori per refrigerante interno. Per tornitura longitudinale senza spallamento, tornitura a copiare, tornitura conica e smussi con inserti tondi negativi RN .. 12 dimensioni. Attacco a cambio rapido PSC (Polygon Shank Coupling) dimensione C6. Corpo trattato per una maggiore durata dell'utensile.

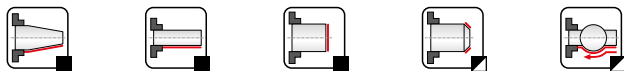
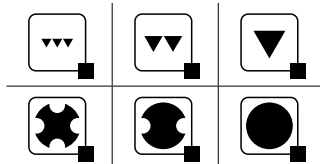
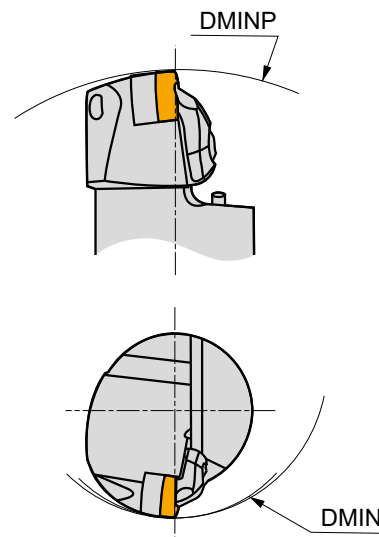
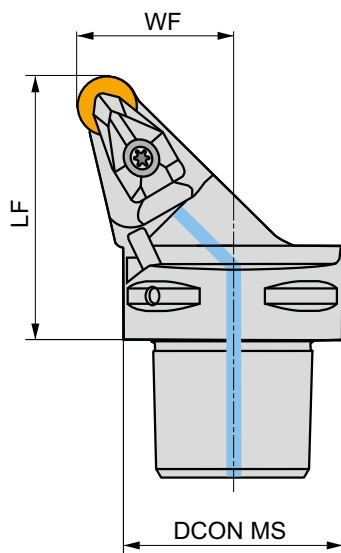
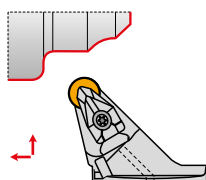

Codice prodotto	DCON MS (mm)	DMIN (mm)	DMINP (mm)	WF (mm)	LF (mm)	LAMS (°)	GAMO (°)					
R C6-DRSNR-45065-12	63	110	190	45	65	-6	-6	✓	1.11	GI083	C-DR12	-
L C6-DRSNL-45065-12	63	110	190	45	65	-6	-6	✓	1.10	GI083	C-DR12	-



GI083



RN.. 120400



C-DR12



DCS 12



3.9



DRS 155-02



US 2002-T15P



FLAG T15P/3,5



CN 045-01



SN

09/ 12/ 15/ 19/ 25

INSERTI IN METALLO DURO

SNMA	SNMG	SNMM	SNMX
300	301	307	311

INSERTI CER

SNGA CER	SNGN CER
311	312

ABBINAMENTO DELLA DIMENSIONE CORRETTA (esempio)

Inserto	Portainsero
SNMG 190616E-RM	DSDNN 3232 P 19

TORNITURA ISO - ESTERNA

DSBN(RL) EXT 75° SN.. 12 15 19 20×20 40×40 313 300 - 312	DSDNN EXT 45° SN.. 12 15 19 25 20×20 40×40 315 300 - 312	DSKN(RL) EXT 75° SN.. 12 19 25×25 32×32 316 300 - 312	DSSN(RL) EXT 45° SN.. 12 15 19 20×20 40×40 317 300 - 312
PSBN(RL) EXT 75° SN.. 12 15 19 25 20×20 50×50 318 300 - 312	PSDNN EXT 45° SN.. 12 15 19 25 20×20 50×50 320 300 - 312	PSKN(RL) EXT 75° SN.. 12 15 19 25 20×20 50×50 321 300 - 312	PSSN(RL) EXT 45° SN.. 19 25 40×40 50×50 323 300 - 312



SN

09/ 12/ 15/ 19/ 25

C.-DSDNN EXT **NEW**

45°		SN..
		12 19
	C4 C6	
		324 300 - 312

C.-DSKN(RL) EXT **NEW**

75°		SN..
		12
	C4	
		325 300 - 312

C.-DSRN(RL) EXT **NEW**

75°		SN..
		12 19
	C4 C6	
		326 300 - 312

C.-DSSN(RL) EXT **NEW**

45°		SN..
		12
	C4 C5	
		327 300 - 312

TORNITURA ISO - SGROSSATURA PESANTE - ESTERNA

KHP-SBNR + DKH(RL)

75°		SN..
		25
	40×50 60×80	
		328, 330 300 - 312

KHP-SBNL + DKH(RL)

75°		SN..
		25
	40×50 60×80	
		328, 330 300 - 312

KHP-SSNR/L + DKH(RL)

45°		SN..
		19 25
	40×50 60×80	
		329, 330 300 - 312

TORNITURA ISO INTERNA

PSKN(RL) INT

93°		SN..
		11 15
	32 80	
		331 300 - 312



SNMA

	IC	D1	L	S
	(mm)	(mm)	(mm)	(mm)
1204	12.700	5.16	12.70	4.76
1506	15.875	6.35	15.875	6.35
1906	19.050	7.94	19.05	6.35
2507	25.400	9.12	25.40	7.94
2509	25.400	9.12	25.40	9.525

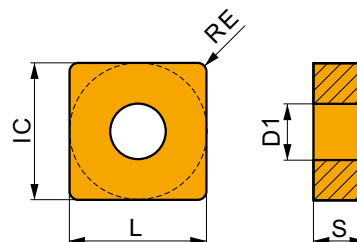

Idoneità e valori iniziali per velocità di taglio (Vc), avanzamento (f) e profondità di taglio (ap). Fare riferimento alla nostra App Machining Calculator per ulteriori calcoli.

Codice prodotto	RE	P			M			K			N			S			H		
		vc	f	ap	vc	f	ap	vc	f	ap	vc	f	ap	vc	f	ap	vc	f	ap
	(mm)	(m/min)	(mm/rev)	(mm)	(m/min)	(mm/rev)	(mm)	(m/min)	(mm/rev)	(mm)	(m/min)	(mm/rev)	(mm)	(m/min)	(mm/rev)	(mm)	(m/min)	(mm/rev)	(mm)

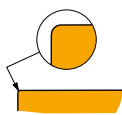

Adatta per operazioni da finitura fino a semi sgrossatura, da taglio continuo a leggermente interrotto.

SNMA 120408	T5305	0.8	-	-	-	-	-	-	230	0.20	4.0	-	-	-	-	-	45	0.15	1.0
	T5315	0.8	-	-	-	-	-	-	200	0.20	4.0	-	-	-	-	-	40	0.15	1.0
	T6310	0.8	-	-	-	-	-	-	100	0.20	4.0	-	-	-	-	-	25	0.15	1.0
SNMA 120412	T5305	1.2	-	-	-	-	-	-	205	0.30	4.0	-	-	-	-	-	40	0.15	1.0
	T5315	1.2	-	-	-	-	-	-	190	0.30	4.0	-	-	-	-	-	40	0.15	1.0
SNMA 150612	T5305	1.2	-	-	-	-	-	-	200	0.30	5.0	-	-	-	-	-	40	0.15	1.0
	T5315	1.2	-	-	-	-	-	-	185	0.30	5.0	-	-	-	-	-	35	0.15	1.0
SNMA 190612	T5305	1.2	-	-	-	-	-	-	195	0.30	6.0	-	-	-	-	-	40	0.15	1.0
	T5315	1.2	-	-	-	-	-	-	180	0.30	6.0	-	-	-	-	-	35	0.15	1.0
SNMA 190616	T5305	1.6	-	-	-	-	-	-	190	0.40	6.0	-	-	-	-	-	40	0.15	1.0
	T5315	1.6	-	-	-	-	-	-	170	0.40	6.0	-	-	-	-	-	35	0.15	1.0
SNMA 250724	T5305	2.4	-	-	-	-	-	-	95	0.60	8.0	-	-	-	-	-	20	0.15	1.0
	T5315	2.4	-	-	-	-	-	-	90	0.60	8.0	-	-	-	-	-	15	0.15	1.0
SNMA 250924	T5305	2.4	-	-	-	-	-	-	95	0.60	8.0	-	-	-	-	-	20	0.15	1.0
	T5315	2.4	-	-	-	-	-	-	90	0.60	8.0	-	-	-	-	-	15	0.15	1.0

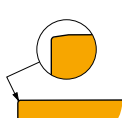

Adatta per operazioni da finitura fino a semi sgrossatura, da taglio continuo a leggermente interrotto.

SNMA 120412S	T5305	1.2	-	-	-	-	-	-	205	0.30	4.0	-	-	-	-	-	40	0.15	1.0
SNMA 190616S	T5305	1.6	-	-	-	-	-	-	195	0.30	6.0	-	-	-	-	-	40	0.15	1.0
SNMA 250724S	T5305	2.4	-	-	-	-	-	-	95	0.60	8.0	-	-	-	-	-	20	0.15	1.0
SNMA 250924S	T5305	2.4	-	-	-	-	-	-	95	0.60	8.0	-	-	-	-	-	20	0.15	1.0



SNMG



	IC (mm)	D1 (mm)	L (mm)	S (mm)
1204	12.700	5.16	12.70	4.76
1506	15.875	6.35	15.875	6.35
1906	19.050	7.94	19.05	6.35
2507	25.400	9.12	25.40	7.94
2509	25.400	9.12	25.40	9.525

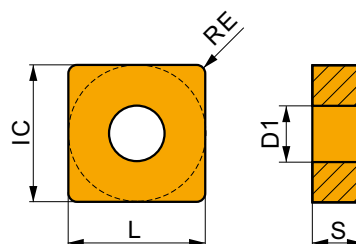

Idoneità e valori iniziali per velocità di taglio (Vc), avanzamento (f) e profondità di taglio (ap). Fare riferimento alla nostra App Machining Calculator per ulteriori calcoli.

Codice prodotto	RE (mm)	P			M			K			N			S			H		
		vc (m/min)	f (mm/rev)	ap (mm)	vc (m/min)	f (mm/rev)	ap (mm)	vc (m/min)	f (mm/rev)	ap (mm)	vc (m/min)	f (mm/rev)	ap (mm)	vc (m/min)	f (mm/rev)	ap (mm)	vc (m/min)	f (mm/rev)	ap (mm)

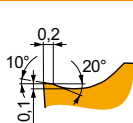

FM geometria positiva per operazioni da finitura fino a semi sgrossatura, da taglio continuo a leggermente interrotto.

SNMG 120404E-FM	T6310	0.4	175	0.20	2.1	125	0.18	2.1	140	0.20	2.1	-	-	-	50	0.14	1.7	-	-	-
	T7325	0.4	195	0.20	2.1	150	0.18	2.1	-	-	-	-	-	-	60	0.16	1.7	-	-	-
	T8315	0.4	180	0.20	2.1	105	0.18	2.1	170	0.20	2.1	-	-	-	45	0.14	1.7	-	-	-
	T8330	0.4	175	0.20	2.1	105	0.18	2.1	165	0.20	2.1	-	-	-	40	0.14	1.7	-	-	-
	T8430	0.4	195	0.20	2.1	105	0.18	2.1	160	0.20	2.1	-	-	-	40	0.14	1.7	-	-	-
	T9315	0.4	270	0.20	2.1	-	-	-	255	0.20	2.1	-	-	-	-	-	-	-	-	-
SNMG 120408E-FM	T9325	0.4	240	0.20	2.1	140	0.18	2.1	225	0.20	2.1	-	-	-	50	0.16	1.7	-	-	-
	T7325	0.8	235	0.20	2.1	180	0.18	2.1	-	-	-	-	-	-	75	0.16	1.7	-	-	-
	T8315	0.8	215	0.20	2.1	125	0.18	2.1	200	0.20	2.1	-	-	-	50	0.16	1.7	-	-	-
	T8330	0.8	205	0.20	2.1	120	0.18	2.1	190	0.20	2.1	-	-	-	50	0.16	1.7	-	-	-
	T8430	0.8	235	0.20	2.1	125	0.18	2.1	190	0.20	2.1	-	-	-	50	0.16	1.7	-	-	-
	T9310	0.8	355	0.20	2.1	-	-	-	335	0.20	2.1	-	-	-	-	-	-	-	-	-
SNMG 120412E-FM	T9315	0.8	320	0.20	2.1	-	-	-	300	0.20	2.1	-	-	-	-	-	-	-	-	-
	T9325	0.8	290	0.20	2.1	170	0.18	2.1	275	0.20	2.1	-	-	-	65	0.16	1.7	-	-	-
	T8330	1.2	200	0.27	2.1	120	0.24	2.1	190	0.27	2.1	-	-	-	50	0.19	1.7	-	-	-
	T8430	1.2	220	0.27	2.1	120	0.24	2.1	180	0.27	2.1	-	-	-	45	0.19	1.7	-	-	-
SNMG 120416E-FM	T9315	1.2	300	0.27	2.1	-	-	-	285	0.27	2.1	-	-	-	-	-	-	-	-	-
	T9325	1.2	270	0.27	2.1	160	0.24	2.1	255	0.27	2.1	-	-	-	60	0.19	1.7	-	-	-
	T8330	1.6	200	0.32	2.1	120	0.29	2.1	190	0.32	2.1	-	-	-	50	0.22	1.7	-	-	-
SNMG 120416E-FM	T8430	1.6	220	0.32	2.1	120	0.29	2.1	180	0.32	2.1	-	-	-	45	0.22	1.7	-	-	-
	T9325	1.6	260	0.32	2.1	155	0.29	2.1	245	0.32	2.1	-	-	-	55	0.22	1.7	-	-	-

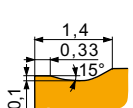

KR geometria per operazioni da semi sgrossatura fino a sgrossatura, da taglio continuo a interrotto.

SNMG 120408E-KR	T5305	0.8	265	0.35	3.8	-	-	-	250	0.35	3.8	-	-	-	-	-	-	50	0.15	1.0
	T5315	0.8	235	0.35	3.8	-	-	-	220	0.35	3.8	-	-	-	-	-	-	45	0.15	1.0
SNMG 120412E-KR	T5305	1.2	265	0.40	3.8	-	-	-	250	0.40	3.8	-	-	-	-	-	-	50	0.15	1.0
	T5315	1.2	240	0.40	3.8	-	-	-	225	0.40	3.8	-	-	-	-	-	-	45	0.15	1.0

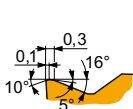

M geometria per operazioni da finitura fino a semi sgrossatura, da taglio continuo a interrotto.

SNMG 120408E-M	T5305	0.8	290	0.32	2.1	-	-	-	275	0.32	2.1	-	-	-	-	-	-	55	0.15	1.0
	T5315	0.8	260	0.32	2.1	-	-	-	245	0.32	2.1	-	-	-	-	-	-	50	0.15	1.0
	T9310	0.8	255	0.32	2.1	-	-	-	240	0.32	2.1	-	-	-	-	-	-	50	0.15	1.0
	T9315	0.8	235	0.32	2.1	-	-	-	220	0.32	2.1	-	-	-	-	-	-	45	0.15	1.0
	T9325	0.8	210	0.32	2.1	-	-	-	195	0.32	2.1	-	-	-	-	-	-	-	-	-
	T9335	0.8	185	0.32	2.1	-	-	-	-	-	-	-	-	-	-	-	-	-	-	-



Idoneità e valori iniziali per velocità di taglio (Vc), avanzamento (f) e profondità di taglio (ap). Fare riferimento alla nostra App Machining Calculator per ulteriori calcoli.

Codice prodotto	RE  (mm)	P			M			K			N			S			H		
		vc (m/min)	f (mm/rev)	ap (mm)	vc (m/min)	f (mm/rev)	ap (mm)	vc (m/min)	f (mm/rev)	ap (mm)	vc (m/min)	f (mm/rev)	ap (mm)	vc (m/min)	f (mm/rev)	ap (mm)	vc (m/min)	f (mm/rev)	ap (mm)

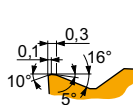

M geometria per operazioni da finitura fino a semi sgrassatura, da taglio continuo a interrotto.

SNMG 120412E-M	T9315	1.2	230	0.40	2.1	—	—	—	215	0.40	2.1	—	—	—	—	—	—	—	45	0.15	1.0
	T9325	1.2	200	0.40	2.1	—	—	—	190	0.40	2.1	—	—	—	—	—	—	—	—	—	—
	T9335	1.2	175	0.40	2.1	—	—	—	—	—	—	—	—	—	—	—	—	—	—	—	—
SNMG 120416E-M	T9325	1.6	210	0.40	2.1	—	—	—	195	0.40	2.1	—	—	—	—	—	—	—	—	—	—
SNMG 150612E-M	T9315	1.2	220	0.40	3.4	—	—	—	205	0.40	3.4	—	—	—	—	—	—	—	40	0.15	1.0
	T9325	1.2	195	0.40	3.4	—	—	—	185	0.40	3.4	—	—	—	—	—	—	—	—	—	—
	T9335	1.2	170	0.40	3.4	—	—	—	—	—	—	—	—	—	—	—	—	—	—	—	—
SNMG 190612E-M	T9315	1.2	215	0.40	4.0	—	—	—	200	0.40	4.0	—	—	—	—	—	—	—	40	0.15	1.0
	T9325	1.2	190	0.40	4.0	—	—	—	180	0.40	4.0	—	—	—	—	—	—	—	—	—	—
	T9335	1.2	165	0.40	4.0	—	—	—	—	—	—	—	—	—	—	—	—	—	—	—	—
SNMG 190616E-M	T9315	1.6	225	0.40	4.0	—	—	—	210	0.40	4.0	—	—	—	—	—	—	—	45	0.15	1.0
	T9325	1.6	200	0.40	4.0	—	—	—	190	0.40	4.0	—	—	—	—	—	—	—	—	—	—
	T9335	1.6	175	0.40	4.0	—	—	—	—	—	—	—	—	—	—	—	—	—	—	—	—

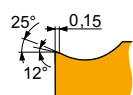

NF geometria con design altamente positivo per operazioni da finitura fino a medie lavorazioni, taglio continuo.

SNMG 120404E-NF	T6310	0.4	185	0.17	1.7	130	0.15	1.7	145	0.17	1.7	555	0.20	1.7	55	0.14	1.4	—	—	—	
	T7325	0.4	210	0.18	1.7	160	0.16	1.7	—	—	—	—	—	—	65	0.16	1.4	—	—	—	
	T7335	0.4	205	0.18	1.7	155	0.16	1.7	—	—	—	—	—	—	65	0.16	1.4	—	—	—	
	T8330	0.4	185	0.17	1.7	110	0.15	1.7	175	0.17	1.7	555	0.20	1.7	45	0.14	1.4	—	—	—	
	T8430	0.4	210	0.17	1.7	115	0.15	1.7	175	0.17	1.7	585	0.20	1.7	45	0.14	1.4	—	—	—	
	T9315	0.4	300	0.17	1.7	—	—	—	285	0.17	1.7	—	—	—	—	—	—	—	—	—	—
	T9325	0.4	260	0.18	1.7	155	0.16	1.7	245	0.18	1.7	—	—	—	55	0.16	1.4	—	—	—	
	SNMG 120408E-NF	HF7	0.8	—	—	—	120	0.17	1.7	190	0.19	1.7	600	0.23	1.7	—	—	—	—	—	—
T6310	0.8	210	0.19	1.7	150	0.17	1.7	165	0.19	1.7	630	0.23	1.7	60	0.15	1.4	—	—	—		
T7325	0.8	245	0.19	1.7	190	0.17	1.7	—	—	—	—	—	—	75	0.15	1.4	—	—	—		
T7335	0.8	240	0.19	1.7	185	0.17	1.7	—	—	—	—	—	—	75	0.15	1.4	—	—	—		
T8315	0.8	230	0.19	1.7	135	0.17	1.7	215	0.19	1.7	690	0.23	1.7	55	0.15	1.4	—	—	—		
T8330	0.8	210	0.19	1.7	125	0.17	1.7	195	0.19	1.7	630	0.23	1.7	50	0.15	1.4	—	—	—		
T8430	0.8	250	0.19	1.7	135	0.17	1.7	205	0.19	1.7	690	0.23	1.7	50	0.15	1.4	—	—	—		
T9315	0.8	340	0.19	1.7	—	—	—	320	0.19	1.7	—	—	—	—	—	—	—	—	—	—	
T9325	0.8	300	0.19	1.7	180	0.17	1.7	285	0.19	1.7	—	—	—	65	0.15	1.4	—	—	—		

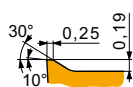

NM geometria con design altamente positivo per operazioni di finitura, media sgrassatura, taglio continuo.

SNMG 120408E-NM	T7325	0.8	225	0.25	2.1	175	0.23	2.1	—	—	—	—	—	70	0.20	1.7	—	—	—	
	T7335	0.8	220	0.25	2.1	170	0.23	2.1	—	—	—	—	—	70	0.20	1.7	—	—	—	
	T8315	0.8	215	0.25	2.1	125	0.23	2.1	—	—	—	645	0.30	2.1	50	0.20	1.7	—	—	—
	T8330	0.8	205	0.25	2.1	120	0.23	2.1	—	—	—	615	0.30	2.1	50	0.20	1.7	—	—	—
	T8430	0.8	225	0.25	2.1	120	0.23	2.1	—	—	—	615	0.30	2.1	45	0.20	1.7	—	—	—
	T9325	0.8	275	0.25	2.1	165	0.23	2.1	—	—	—	—	—	60	0.20	1.7	—	—	—	
SNMG 120412E-NM	T7325	1.2	225	0.30	2.1	175	0.27	2.1	—	—	—	—	—	70	0.24	1.7	—	—	—	
	T7335	1.2	220	0.30	2.1	170	0.27	2.1	—	—	—	—	—	70	0.24	1.7	—	—	—	
	T8315	1.2	215	0.30	2.1	125	0.27	2.1	—	—	—	645	0.36	2.1	50	0.24	1.7	—	—	—
	T9325	1.2	270	0.30	2.1	160	0.27	2.1	—	—	—	—	—	60	0.24	1.7	—	—	—	



Idoneità e valori iniziali per velocità di taglio (Vc), avanzamento (f) e profondità di taglio (ap). Fare riferimento alla nostra App Machining Calculator per ulteriori calcoli.

Codice prodotto	RE (mm)	P			M			K			N			S			H		
		vc (m/min)	f (mm/rev)	ap (mm)	vc (m/min)	f (mm/rev)	ap (mm)	vc (m/min)	f (mm/rev)	ap (mm)	vc (m/min)	f (mm/rev)	ap (mm)	vc (m/min)	f (mm/rev)	ap (mm)	vc (m/min)	f (mm/rev)	ap (mm)

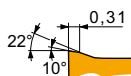

NMR geometria con design positivo per operazioni da media fino a sgrossatura, taglio continuo.

SNMG 120408E-NMR	T6310	0.8	■	155	0.35	2.6	■	110	0.32	2.6	■	-	-	-	■	45	0.25	2.1	-	-	-
	T7325	0.8	▣	175	0.35	2.6	■	135	0.32	2.6	■	-	-	-	■	55	0.25	2.1	-	-	-
	T7335	0.8	▣	165	0.35	2.6	■	125	0.32	2.6	■	-	-	-	■	50	0.25	2.1	-	-	-
	T8330	0.8	■	155	0.35	2.6	■	90	0.32	2.6	■	-	-	-	▣	35	0.25	2.1	-	-	-
	T8430	0.8	■	165	0.35	2.6	■	90	0.32	2.6	■	-	-	-	▣	35	0.25	2.1	-	-	-
	T9315	0.8	■	225	0.35	2.6	■	-	-	-	■	-	-	-	-	-	-	-	-	-	-
T9325	0.8	■	200	0.35	2.6	■	120	0.32	2.6	■	-	-	-	▣	45	0.25	2.1	-	-	-	
SNMG 120412E-NMR	T6310	1.2	■	160	0.40	2.6	■	115	0.36	2.6	■	-	-	-	■	45	0.28	2.1	-	-	-
	T7325	1.2	▣	175	0.40	2.6	■	135	0.36	2.6	■	-	-	-	■	55	0.28	2.1	-	-	-
	T7335	1.2	▣	165	0.40	2.6	■	125	0.36	2.6	■	-	-	-	■	50	0.28	2.1	-	-	-
	T9315	1.2	■	225	0.40	2.6	■	-	-	-	■	-	-	-	-	-	-	-	-	-	-
	T9325	1.2	■	200	0.40	2.6	■	120	0.36	2.6	■	-	-	-	▣	45	0.28	2.1	-	-	-
SNMG 120416E-NMR	T7325	1.6	▣	180	0.45	2.6	■	140	0.41	2.6	■	-	-	-	■	55	0.32	2.1	-	-	-
	T7335	1.6	▣	170	0.45	2.6	■	130	0.41	2.6	■	-	-	-	■	55	0.32	2.1	-	-	-
	T9325	1.6	■	200	0.45	2.6	■	120	0.41	2.6	■	-	-	-	▣	45	0.32	2.1	-	-	-
SNMG 150612E-NMR	T6310	1.2	■	150	0.40	3.8	■	105	0.36	3.8	■	-	-	-	■	45	0.28	3.0	-	-	-
	T7325	1.2	▣	170	0.40	3.8	■	130	0.36	3.8	■	-	-	-	■	55	0.28	3.0	-	-	-
	T9315	1.2	■	215	0.40	3.8	■	-	-	-	■	-	-	-	-	-	-	-	-	-	-
	T9325	1.2	■	190	0.40	3.8	■	110	0.36	3.8	■	-	-	-	▣	40	0.28	3.0	-	-	-
SNMG 190612E-NMR	T6310	1.2	■	145	0.40	5.2	■	100	0.36	5.2	■	-	-	-	■	40	0.28	4.2	-	-	-
	T7325	1.2	▣	165	0.40	5.2	■	125	0.36	5.2	■	-	-	-	■	50	0.28	4.2	-	-	-
	T7335	1.2	▣	155	0.40	5.2	■	120	0.36	5.2	■	-	-	-	■	50	0.28	4.2	-	-	-
	T9315	1.2	■	210	0.40	5.2	■	-	-	-	■	-	-	-	-	-	-	-	-	-	-
	T9325	1.2	■	185	0.40	5.2	■	110	0.36	5.2	■	-	-	-	▣	40	0.28	4.2	-	-	-
SNMG 190616E-NMR	T6310	1.6	■	150	0.45	5.2	■	105	0.41	5.2	■	-	-	-	■	45	0.32	4.2	-	-	-
	T7325	1.6	▣	170	0.45	5.2	■	130	0.41	5.2	■	-	-	-	■	55	0.32	4.2	-	-	-
	T7335	1.6	▣	155	0.45	5.2	■	120	0.41	5.2	■	-	-	-	■	50	0.32	4.2	-	-	-
	T9315	1.6	■	205	0.45	5.2	■	-	-	-	■	-	-	-	-	-	-	-	-	-	-
	T9325	1.6	■	185	0.45	5.2	■	110	0.41	5.2	■	-	-	-	▣	40	0.32	4.2	-	-	-

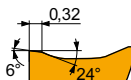
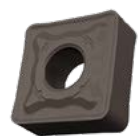

NRM geometria con design positivo per operazioni da semi sgrossatura fino a sgrossatura, da taglio continuo a moderatamente interrotto.

SNMG 120408-NRM	T7325	0.8	▣	175	0.35	2.6	■	135	0.32	2.6	■	-	-	-	■	55	0.28	2.1	-	-	-
	T7335	0.8	▣	165	0.35	2.6	■	125	0.32	2.6	■	-	-	-	■	50	0.28	2.1	-	-	-
	T9315	0.8	■	225	0.35	2.6	■	-	-	-	■	-	-	-	-	-	-	-	-	-	-
SNMG 120412-NRM	T7325	1.2	▣	175	0.40	3.0	■	135	0.36	3.0	■	-	-	-	■	55	0.28	2.4	-	-	-
	T7335	1.2	▣	165	0.40	3.0	■	125	0.36	3.0	■	-	-	-	■	50	0.28	2.4	-	-	-
	T9315	1.2	■	220	0.40	3.0	■	-	-	-	■	-	-	-	-	-	-	-	-	-	-
SNMG 150612-NRM	T7325	1.2	▣	170	0.40	4.0	■	130	0.36	4.0	■	-	-	-	■	55	0.32	3.2	-	-	-
	T7335	1.2	▣	160	0.40	4.0	■	120	0.36	4.0	■	-	-	-	■	50	0.32	3.2	-	-	-
	T9315	1.2	■	215	0.40	4.0	■	-	-	-	■	-	-	-	-	-	-	-	-	-	-
SNMG 150616-NRM	T7325	1.6	▣	170	0.45	5.0	■	130	0.41	5.0	■	-	-	-	■	55	0.36	4.0	-	-	-
	T7335	1.6	▣	155	0.45	5.0	■	120	0.41	5.0	■	-	-	-	■	50	0.36	4.0	-	-	-
	T9315	1.6	■	205	0.45	5.0	■	-	-	-	■	-	-	-	-	-	-	-	-	-	-
SNMG 190612-NRM	T7325	1.2	▣	165	0.40	5.2	■	125	0.36	5.2	■	-	-	-	■	50	0.32	4.2	-	-	-
	T7335	1.2	▣	155	0.40	5.2	■	120	0.36	5.2	■	-	-	-	■	50	0.32	4.2	-	-	-
	T9315	1.2	■	210	0.40	5.2	■	-	-	-	■	-	-	-	-	-	-	-	-	-	-
SNMG 190616-NRM	T7325	1.6	▣	170	0.45	5.2	■	130	0.41	5.2	■	-	-	-	■	55	0.36	4.2	-	-	-
	T7335	1.6	▣	155	0.45	5.2	■	120	0.41	5.2	■	-	-	-	■	50	0.36	4.2	-	-	-
	T9315	1.6	■	205	0.45	5.2	■	-	-	-	■	-	-	-	-	-	-	-	-	-	-
SNMG 250724-NRM	T7325	2.4	▣	105	0.65	9.0	■	80	0.59	9.0	■	-	-	-	■	30	0.46	7.2	-	-	-
	T7335	2.4	▣	100	0.65	9.0	■	75	0.59	9.0	■	-	-	-	■	30	0.46	7.2	-	-	-
	T9315	2.4	■	120	0.65	9.0	■	-	-	-	▣	110	0.65	9.0	■	-	-	-	-	-	-



Idoneità e valori iniziali per velocità di taglio (Vc), avanzamento (f) e profondità di taglio (ap). Fare riferimento alla nostra App Machining Calculator per ulteriori calcoli.

Codice prodotto	RE  (mm)	P			M			K			N			S			H		
		vc (m/min)	f (mm/rev)	ap (mm)	vc (m/min)	f (mm/rev)	ap (mm)	vc (m/min)	f (mm/rev)	ap (mm)	vc (m/min)	f (mm/rev)	ap (mm)	vc (m/min)	f (mm/rev)	ap (mm)	vc (m/min)	f (mm/rev)	ap (mm)

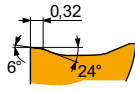

NRM geometria con design positivo per operazioni da semi sgrossatura fino a sgrossatura, da taglio continuo a moderatamente interrotto.

SNMG 250924-NRM	T7325	2.4	105	0.70	9.0	80	0.63	9.0	–	–	–	–	–	–	–	–	–	–	–
	T7335	2.4	95	0.70	9.0	70	0.63	9.0	–	–	–	–	–	–	–	–	–	–	–
	T9315	2.4	120	0.70	9.0	–	–	–	110	0.70	9.0	–	–	–	–	–	–	–	–

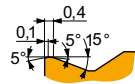

R geometria per operazioni da semi sgrossatura fino a sgrossatura, da taglio continuo a interrotto.

SNMG 120408E-R	6640	0.8	145	0.40	3.8	–	–	–	135	0.40	3.8	–	–	–	–	–	–	–	–	
	T5305	0.8	250	0.40	3.8	–	–	–	235	0.40	3.8	–	–	–	–	–	–	50	0.15	1.0
	T9315	0.8	200	0.40	3.8	–	–	–	190	0.40	3.8	–	–	–	–	–	–	40	0.15	1.0
	T9325	0.8	180	0.40	3.8	–	–	–	170	0.40	3.8	–	–	–	–	–	–	–	–	–
	T9335	0.8	155	0.40	3.8	–	–	–	–	–	–	–	–	–	–	–	–	–	–	–
SNMG 120412E-R	T5305	1.2	255	0.45	3.8	–	–	–	240	0.45	3.8	–	–	–	–	–	–	50	0.15	1.0
	T9310	1.2	220	0.45	3.8	–	–	–	205	0.45	3.8	–	–	–	–	–	–	40	0.15	1.0
	T9325	1.2	180	0.45	3.8	–	–	–	170	0.45	3.8	–	–	–	–	–	–	–	–	–
	T9335	1.2	160	0.45	3.8	–	–	–	–	–	–	–	–	–	–	–	–	–	–	–
SNMG 120416E-R	T9315	1.6	205	0.50	3.8	–	–	–	190	0.50	3.8	–	–	–	–	–	–	40	0.15	1.0
	T9325	1.6	185	0.50	3.8	–	–	–	175	0.50	3.8	–	–	–	–	–	–	–	–	–
SNMG 150612E-R	T5305	1.2	250	0.45	4.5	–	–	–	235	0.45	4.5	–	–	–	–	–	–	50	0.15	1.0
	T5315	1.2	230	0.45	4.5	–	–	–	215	0.45	4.5	–	–	–	–	–	–	45	0.15	1.0
	T9315	1.2	200	0.45	4.5	–	–	–	190	0.45	4.5	–	–	–	–	–	–	40	0.15	1.0
	T9325	1.2	180	0.45	4.5	–	–	–	170	0.45	4.5	–	–	–	–	–	–	–	–	–
SNMG 150616E-R	T5315	1.6	230	0.50	4.5	–	–	–	215	0.50	4.5	–	–	–	–	–	–	45	0.15	1.0
	T9325	1.6	180	0.50	4.5	–	–	–	170	0.50	4.5	–	–	–	–	–	–	–	–	–
SNMG 190612E-R	6640	1.2	140	0.45	6.0	–	–	–	130	0.45	6.0	–	–	–	–	–	–	–	–	–
	T9310	1.2	210	0.45	6.0	–	–	–	195	0.45	6.0	–	–	–	–	–	–	40	0.15	1.0
	T9315	1.2	195	0.45	6.0	–	–	–	185	0.45	6.0	–	–	–	–	–	–	35	0.15	1.0
	T9325	1.2	175	0.45	6.0	–	–	–	165	0.45	6.0	–	–	–	–	–	–	–	–	–
SNMG 190616E-R	T9310	1.6	205	0.50	6.0	–	–	–	190	0.50	6.0	–	–	–	–	–	–	40	0.15	1.0
	T9315	1.6	195	0.50	6.0	–	–	–	185	0.50	6.0	–	–	–	–	–	–	35	0.15	1.0
	T9325	1.6	175	0.50	6.0	–	–	–	165	0.50	6.0	–	–	–	–	–	–	–	–	–
	T9335	1.6	150	0.50	6.0	–	–	–	–	–	–	–	–	–	–	–	–	–	–	–

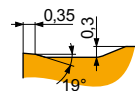

RM geometria per operazioni da semi sgrossatura fino a sgrossatura, da taglio continuo a interrotto.

SNMG 120408E-RM	T5305	0.8	290	0.40	4.0	–	–	–	275	0.40	4.0	–	–	–	–	–	–	–	–	
	T5315	0.8	260	0.40	4.0	–	–	–	245	0.40	4.0	–	–	–	–	–	–	–	–	
	T6310	0.8	165	0.40	4.0	115	0.36	4.0	130	0.40	4.0	–	–	–	–	–	–	–	–	
	T7325	0.8	185	0.40	4.0	140	0.36	4.0	–	–	–	–	–	–	–	–	–	–	–	
	T7335	0.8	175	0.40	4.0	135	0.36	4.0	–	–	–	–	–	–	–	–	–	–	–	
	T8315	0.8	175	0.40	4.0	105	0.36	4.0	165	0.40	4.0	–	–	–	–	–	–	–	–	–
	T8330	0.8	165	0.40	4.0	95	0.36	4.0	155	0.40	4.0	–	–	–	–	–	–	–	–	–
	T8430	0.8	175	0.40	4.0	95	0.36	4.0	140	0.40	4.0	–	–	–	–	–	–	–	–	–
	T9310	0.8	250	0.40	4.0	–	–	–	235	0.40	4.0	–	–	–	–	–	–	–	–	–
	T9315	0.8	235	0.40	4.0	–	–	–	220	0.40	4.0	–	–	–	–	–	–	–	–	–
	T9325	0.8	210	0.40	4.0	125	0.36	4.0	195	0.40	4.0	–	–	–	–	–	–	–	–	–
	T9335	0.8	180	0.40	4.0	105	0.36	4.0	–	–	–	–	–	–	–	–	–	–	–	–



Idoneità e valori iniziali per velocità di taglio (Vc), avanzamento (f) e profondità di taglio (ap). Fare riferimento alla nostra App Machining Calculator per ulteriori calcoli.

Codice prodotto	RE  (mm)	P			M			K			N			S			H		
		vc (m/min)	f (mm/rev)	ap (mm)	vc (m/min)	f (mm/rev)	ap (mm)	vc (m/min)	f (mm/rev)	ap (mm)	vc (m/min)	f (mm/rev)	ap (mm)	vc (m/min)	f (mm/rev)	ap (mm)	vc (m/min)	f (mm/rev)	ap (mm)

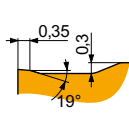
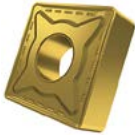

RM geometria per operazioni da semi sgrassatura fino a sgrassatura, da taglio continuo a interrotto.

SNMG 120412E-RM	T5305	1.2	295	0.45	4.0	-	-	-	280	0.45	4.0	-	-	-	-	-	-	-	
	T5315	1.2	265	0.45	4.0	-	-	-	250	0.45	4.0	-	-	-	-	-	-	-	
	T6310	1.2	165	0.45	4.0	115	0.41	4.0	130	0.45	4.0	-	-	-	-	-	-	-	
	T7325	1.2	190	0.45	4.0	145	0.41	4.0	-	-	-	-	-	-	-	-	-	-	
	T7335	1.2	180	0.45	4.0	140	0.41	4.0	-	-	-	-	-	-	-	-	-	-	
	T9310	1.2	250	0.45	4.0	-	-	-	235	0.45	4.0	-	-	-	-	-	-	-	-
	T9315	1.2	235	0.45	4.0	-	-	-	220	0.45	4.0	-	-	-	-	-	-	-	-
	T9325	1.2	210	0.45	4.0	125	0.41	4.0	195	0.45	4.0	-	-	-	-	-	-	-	-
	T9335	1.2	185	0.45	4.0	110	0.41	4.0	-	-	-	-	-	-	-	-	-	-	-
SNMG 120416E-RM	T5315	1.6	270	0.50	4.0	-	-	-	255	0.50	4.0	-	-	-	-	-	-	-	
	T7335	1.6	180	0.50	4.0	140	0.45	4.0	-	-	-	-	-	-	-	-	-	-	
	T8330	1.6	170	0.50	4.0	100	0.45	4.0	160	0.50	4.0	-	-	-	-	-	-	-	
	T8430	1.6	175	0.50	4.0	95	0.45	4.0	140	0.50	4.0	-	-	-	-	-	-	-	
	T9315	1.6	230	0.50	4.0	-	-	-	215	0.50	4.0	-	-	-	-	-	-	-	-
	T9325	1.6	215	0.50	4.0	125	0.45	4.0	200	0.50	4.0	-	-	-	-	-	-	-	-
SNMG 150612E-RM	T5315	1.2	255	0.45	5.0	-	-	-	240	0.45	5.0	-	-	-	-	-	-	-	
	T6310	1.2	165	0.45	5.0	115	0.41	5.0	130	0.45	5.0	-	-	-	-	-	-	-	
	T7325	1.2	185	0.45	5.0	140	0.41	5.0	-	-	-	-	-	-	-	-	-	-	
	T7335	1.2	175	0.45	5.0	135	0.41	5.0	-	-	-	-	-	-	-	-	-	-	
	T9310	1.2	245	0.45	5.0	-	-	-	230	0.45	5.0	-	-	-	-	-	-	-	-
	T9315	1.2	225	0.45	5.0	-	-	-	210	0.45	5.0	-	-	-	-	-	-	-	-
	T9325	1.2	205	0.45	5.0	120	0.41	5.0	190	0.45	5.0	-	-	-	-	-	-	-	
SNMG 150616E-RM	T7335	1.6	175	0.50	5.0	135	0.45	5.0	-	-	-	-	-	-	-	-	-	-	
	T9315	1.6	230	0.50	5.0	-	-	-	215	0.50	5.0	-	-	-	-	-	-	-	
	T9325	1.6	205	0.50	5.0	120	0.45	5.0	190	0.50	5.0	-	-	-	-	-	-	-	
	T9335	1.6	180	0.50	5.0	105	0.45	5.0	-	-	-	-	-	-	-	-	-	-	
SNMG 190612E-RM	T5305	1.2	275	0.45	7.0	-	-	-	260	0.45	7.0	-	-	-	-	-	-	-	
	T5315	1.2	250	0.45	7.0	-	-	-	235	0.45	7.0	-	-	-	-	-	-	-	
	T7325	1.2	180	0.45	7.0	140	0.41	7.0	-	-	-	-	-	-	-	-	-	-	
	T7335	1.2	165	0.45	7.0	125	0.41	7.0	-	-	-	-	-	-	-	-	-	-	
	T9310	1.2	240	0.45	7.0	-	-	-	225	0.45	7.0	-	-	-	-	-	-	-	
	T9315	1.2	220	0.45	7.0	-	-	-	205	0.45	7.0	-	-	-	-	-	-	-	-
	T9325	1.2	195	0.45	7.0	115	0.41	7.0	185	0.45	7.0	-	-	-	-	-	-	-	
	T9335	1.2	175	0.45	7.0	105	0.41	7.0	-	-	-	-	-	-	-	-	-	-	
SNMG 190616E-RM	T5305	1.6	285	0.50	7.0	-	-	-	270	0.50	7.0	-	-	-	-	-	-	-	
	T5315	1.6	250	0.50	7.0	-	-	-	235	0.50	7.0	-	-	-	-	-	-	-	
	T6310	1.6	160	0.50	7.0	115	0.45	7.0	125	0.50	7.0	-	-	-	-	-	-	-	
	T7335	1.6	170	0.50	7.0	130	0.45	7.0	-	-	-	-	-	-	-	-	-	-	
	T9310	1.6	240	0.50	7.0	-	-	-	225	0.50	7.0	-	-	-	-	-	-	-	
	T9315	1.6	220	0.50	7.0	-	-	-	205	0.50	7.0	-	-	-	-	-	-	-	
	T9325	1.6	200	0.50	7.0	120	0.45	7.0	190	0.50	7.0	-	-	-	-	-	-	-	
	T9335	1.6	175	0.50	7.0	105	0.45	7.0	-	-	-	-	-	-	-	-	-	-	
SNMG 250924E-RM	T7325	2.4	110	0.80	12.0	85	0.72	12.0	-	-	-	-	-	-	-	-	-	-	
	T7335	2.4	105	0.80	12.0	80	0.72	12.0	-	-	-	-	-	-	-	-	-	-	
	T9226	2.4	95	0.80	12.0	55	0.72	12.0	90	0.80	12.0	-	-	-	-	-	-	-	
	T9315	2.4	125	0.80	12.0	-	-	-	115	0.80	12.0	-	-	-	-	-	-	-	
	T9325	2.4	110	0.80	12.0	65	0.72	12.0	100	0.80	12.0	-	-	-	-	-	-	-	
	T9335	2.4	90	0.80	12.0	50	0.72	12.0	-	-	-	-	-	-	-	-	-	-	

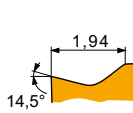

SF geometria con design positivo per operazioni di finitura su pareti sottili, taglio continuo.

SNMG 120404E-SF	T7325	0.4	215	0.17	1.0	165	0.15	1.0	-	-	-	-	-	-	65	0.15	0.8	-	-	-
	T9325	0.4	265	0.17	1.0	155	0.15	1.0	250	0.17	1.0	-	-	-	55	0.15	0.8	-	-	-



Idoneità e valori iniziali per velocità di taglio (Vc), avanzamento (f) e profondità di taglio (ap). Fare riferimento alla nostra App Machining Calculator per ulteriori calcoli.

Codice prodotto	RE  (mm)	P			M			K			N			S			H		
		vc (m/min)	f (mm/rev)	ap (mm)	vc (m/min)	f (mm/rev)	ap (mm)	vc (m/min)	f (mm/rev)	ap (mm)	vc (m/min)	f (mm/rev)	ap (mm)	vc (m/min)	f (mm/rev)	ap (mm)	vc (m/min)	f (mm/rev)	ap (mm)

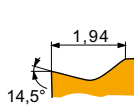

SF geometria con design positivo per operazioni di finitura su pareti sottili, taglio continuo.

SNMG 120408E-SF	H07	0.8	—	—	—	105	0.18	1.0	165	0.20	1.0	525	0.24	1.0	50	0.14	0.8	—	—	—
	T6310	0.8	210	0.20	1.0	150	0.18	1.0	165	0.20	1.0	630	0.24	1.0	60	0.14	0.8	40	0.15	1.0
	T7325	0.8	245	0.20	1.0	190	0.18	1.0	—	—	—	—	—	—	75	0.16	0.8	—	—	—
	T7335	0.8	235	0.20	1.0	180	0.18	1.0	—	—	—	—	—	—	75	0.16	0.8	—	—	—
	T8315	0.8	225	0.20	1.0	135	0.18	1.0	210	0.20	1.0	675	0.24	1.0	55	0.14	0.8	45	0.15	1.0
	T8330	0.8	210	0.20	1.0	125	0.18	1.0	195	0.20	1.0	630	0.24	1.0	50	0.14	0.8	40	0.15	1.0
	T8430	0.8	245	0.20	1.0	135	0.18	1.0	200	0.20	1.0	675	0.24	1.0	50	0.14	0.8	40	0.15	1.0
	T9325	0.8	295	0.20	1.0	175	0.18	1.0	280	0.20	1.0	—	—	—	65	0.16	0.8	—	—	—
SNMG 120412E-SF	T6310	1.2	200	0.25	1.5	140	0.23	1.5	160	0.25	1.5	600	0.30	1.5	60	0.18	1.2	40	0.15	1.0
	T7325	1.2	230	0.25	1.5	175	0.23	1.5	—	—	—	—	—	70	0.18	1.2	—	—	—	
	T8330	1.2	200	0.25	1.5	120	0.23	1.5	190	0.25	1.5	600	0.30	1.5	50	0.18	1.2	40	0.15	1.0
	T8430	1.2	225	0.25	1.5	120	0.23	1.5	185	0.25	1.5	615	0.30	1.5	45	0.18	1.2	35	0.15	1.0

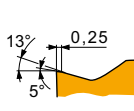

SM geometria con design positivo per medie lavorazioni, da taglio continuo a interrotto.

SNMG 120408E-SM	T6310	0.8	185	0.25	1.8	130	0.23	1.8	145	0.25	1.8	555	0.30	1.8	55	0.20	1.4	35	0.15	1.0
	T7325	0.8	210	0.25	1.8	160	0.23	1.8	—	—	—	—	—	65	0.20	1.4	—	—	—	
	T7335	0.8	205	0.25	1.8	155	0.23	1.8	—	—	—	—	—	65	0.20	1.4	—	—	—	
	T8330	0.8	185	0.25	1.8	110	0.23	1.8	175	0.25	1.8	555	0.30	1.8	45	0.20	1.4	35	0.15	1.0
	T8430	0.8	205	0.25	1.8	110	0.23	1.8	170	0.25	1.8	570	0.30	1.8	45	0.20	1.4	35	0.15	1.0
	T9315	0.8	280	0.25	1.8	—	—	—	265	0.25	1.8	—	—	—	—	—	—	55	0.15	1.0
T9325	0.8	255	0.25	1.8	150	0.23	1.8	240	0.25	1.8	—	—	—	55	0.20	1.4	—	—	—	
SNMG 120412E-SM	T7325	1.2	210	0.30	1.8	160	0.27	1.8	—	—	—	—	—	65	0.24	1.4	—	—	—	
	T7335	1.2	200	0.30	1.8	155	0.27	1.8	—	—	—	—	—	65	0.24	1.4	—	—	—	
	T9315	1.2	275	0.30	1.8	—	—	—	260	0.30	1.8	—	—	—	—	—	55	0.15	1.0	
	T9325	1.2	245	0.30	1.8	145	0.27	1.8	230	0.30	1.8	—	—	—	55	0.24	1.4	—	—	—
SNMG 190612E-SM	T6310	1.2	175	0.30	4.0	125	0.27	4.0	140	0.30	4.0	525	0.36	4.0	50	0.27	3.2	35	0.15	1.0
	T7325	1.2	195	0.30	4.0	150	0.27	4.0	—	—	—	—	—	60	0.27	3.2	—	—	—	
	T7335	1.2	185	0.30	4.0	140	0.27	4.0	—	—	—	—	—	60	0.27	3.2	—	—	—	
	T9325	1.2	230	0.30	4.0	135	0.27	4.0	215	0.30	4.0	—	—	—	50	0.27	3.2	—	—	—
SNMG 190616E-SM	T7325	1.6	190	0.40	4.0	145	0.36	4.0	—	—	—	—	—	60	0.32	3.2	—	—	—	
	T7335	1.6	175	0.40	4.0	135	0.36	4.0	—	—	—	—	—	55	0.32	3.2	—	—	—	
	T9325	1.6	210	0.40	4.0	125	0.36	4.0	195	0.40	4.0	—	—	—	45	0.32	3.2	—	—	—



SNMM

	IC (mm)	D1 (mm)	L (mm)	S (mm)
1204	12.700	5.16	12.70	4.76
1506	15.875	6.35	15.875	6.35
1906	19.050	7.94	19.05	6.35
2507	25.400	9.12	25.40	7.94
2509	25.400	9.12	25.40	9.525

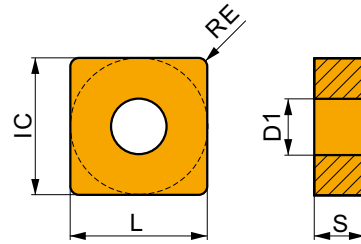

Idoneità e valori iniziali per velocità di taglio (Vc), avanzamento (f) e profondità di taglio (ap). Fare riferimento alla nostra App Machining Calculator per ulteriori calcoli.

Codice prodotto	RE (mm)	P			M			K			N			S			H		
		vc (m/min)	f (mm/rev)	ap (mm)	vc (m/min)	f (mm/rev)	ap (mm)	vc (m/min)	f (mm/rev)	ap (mm)	vc (m/min)	f (mm/rev)	ap (mm)	vc (m/min)	f (mm/rev)	ap (mm)	vc (m/min)	f (mm/rev)	ap (mm)

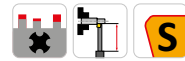
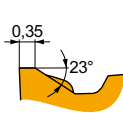

DR geometria per operazioni da semi grossatura fino a grossatura, da taglio continuo a interrotto.

SNMM 120412E-DR	T9315	1.2	245	0.45	4.7	–	–	–	230	0.45	4.7	–	–	–	–	–	–	–
	T9325	1.2	220	0.45	4.7	130	0.41	4.7	205	0.45	4.7	–	–	–	–	–	–	
	T9335	1.2	185	0.45	4.7	110	0.41	4.7	–	–	–	–	–	–	–	–	–	
SNMM 150612E-DR	T9325	1.2	210	0.45	6.0	125	0.41	6.0	195	0.45	6.0	–	–	–	–	–	–	
	T9335	1.2	180	0.45	6.0	105	0.41	6.0	–	–	–	–	–	–	–	–	–	
SNMM 190612E-DR	6640	1.2	170	0.45	6.0	100	0.41	6.0	160	0.45	6.0	–	–	–	–	–	–	
	T9325	1.2	210	0.45	6.0	125	0.41	6.0	195	0.45	6.0	–	–	–	–	–	–	
	T9335	1.2	180	0.45	6.0	105	0.41	6.0	–	–	–	–	–	–	–	–	–	
SNMM 190616E-DR	T9325	1.6	210	0.50	6.0	125	0.45	6.0	195	0.50	6.0	–	–	–	–	–	–	
	T9335	1.6	185	0.50	6.0	110	0.45	6.0	–	–	–	–	–	–	–	–	–	

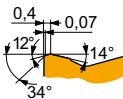











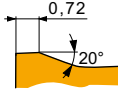

HR geometria per operazioni da grossatura fino a grossatura pesante, taglio continuo e interrotto.

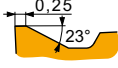
SNMM 190616E-HR	T8345	1.6	60	0.60	9.0	35	0.54	9.0	55	0.60	9.0	–	–	–	–	–	–
	T9325	1.6	110	0.60	9.0	65	0.54	9.0	100	0.60	9.0	–	–	–	–	–	–
	T9335	1.6	85	0.60	9.0	50	0.54	9.0	–	–	–	–	–	–	–	–	–
SNMM 190624E-HR	T8345	2.4	60	0.65	9.0	35	0.59	9.0	55	0.65	9.0	–	–	–	–	–	–
	T9315	2.4	120	0.65	9.0	–	–	–	110	0.65	9.0	–	–	–	–	–	–
	T9325	2.4	115	0.65	9.0	65	0.59	9.0	105	0.65	9.0	–	–	–	–	–	–
SNMM 250716E-HR	T8345	1.6	60	0.60	13.0	35	0.54	13.0	55	0.60	13.0	–	–	–	–	–	–
	T9325	1.6	100	0.60	13.0	60	0.54	13.0	95	0.60	13.0	–	–	–	–	–	–
	T9335	1.6	85	0.60	13.0	50	0.54	13.0	–	–	–	–	–	–	–	–	–
SNMM 250724E-HR	6640	2.4	80	0.65	13.0	45	0.59	13.0	75	0.65	13.0	–	–	–	–	–	–
	T8345	2.4	55	0.65	13.0	30	0.59	13.0	50	0.65	13.0	–	–	–	–	–	–
	T9315	2.4	120	0.65	13.0	–	–	–	110	0.65	13.0	–	–	–	–	–	–
SNMM 250732E-HR	T9325	2.4	105	0.65	13.0	60	0.59	13.0	95	0.65	13.0	–	–	–	–	–	–
	T9335	2.4	85	0.65	13.0	50	0.59	13.0	–	–	–	–	–	–	–	–	–
	T9325	3.2	95	0.80	13.0	55	0.72	13.0	90	0.80	13.0	–	–	–	–	–	–
SNMM 250924E-HR	T8345	2.4	55	0.65	13.0	30	0.59	13.0	50	0.65	13.0	–	–	–	–	–	–
	T9315	2.4	120	0.65	13.0	–	–	–	110	0.65	13.0	–	–	–	–	–	–
	T9325	2.4	105	0.65	13.0	60	0.59	13.0	95	0.65	13.0	–	–	–	–	–	–
SNMM 250932E-HR	T9325	2.4	85	0.65	13.0	50	0.59	13.0	–	–	–	–	–	–	–	–	–
	T9325	3.2	95	0.80	13.0	55	0.72	13.0	90	0.80	13.0	–	–	–	–	–	–

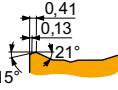

Idoneità e valori iniziali per velocità di taglio (Vc), avanzamento (f) e profondità di taglio (ap). Fare riferimento alla nostra App Machining Calculator per ulteriori calcoli.

Codice prodotto	RE  (mm)	P			M			K			N			S			H		
		vc	f	ap	vc	f	ap	vc	f	ap	vc	f	ap	vc	f	ap	vc	f	ap
		(m/min)	(mm/rev)	(mm)	(m/min)	(mm/rev)	(mm)	(m/min)	(mm/rev)	(mm)	(m/min)	(mm/rev)	(mm)	(m/min)	(mm/rev)	(mm)	(m/min)	(mm/rev)	(mm)
				HR2 geometria per operazioni da sgrossatura fino a sgrossatura pesante, taglio continuo e interrotto.															
SNMM 190616-HR2	T9315	1.6	█ 115	0.65	8.9	–	–	–	█ 105	0.65	8.9	–	–	–	–	–	–	–	–
	T9335	1.6	█ 85	0.65	8.9	█ 50	0.59	8.9	–	–	–	–	–	–	–	–	–	–	–
SNMM 190624-HR2	T9315	2.4	█ 105	0.85	8.9	–	–	–	█ 95	0.85	8.9	–	–	–	–	–	–	–	–
	T9335	2.4	█ 80	0.85	8.9	█ 45	0.77	8.9	–	–	–	–	–	–	–	–	–	–	–
SNMM 250724-HR2	T9226	2.4	█ 85	0.85	11.0	█ 50	0.77	11.0	█ 80	0.85	11.0	–	–	–	–	–	–	–	–
	T9315	2.4	█ 105	0.85	11.0	–	–	–	█ 95	0.85	11.0	–	–	–	–	–	–	–	–
	T9335	2.4	█ 80	0.85	11.0	█ 45	0.77	11.0	–	–	–	–	–	–	–	–	–	–	–
SNMM 250732-HR2	T9315	3.2	█ 95	1.00	11.0	–	–	–	█ 90	1.00	11.0	–	–	–	–	–	–	–	–
SNMM 250924-HR2	T9226	2.4	█ 85	0.85	11.0	█ 50	0.77	11.0	█ 80	0.85	11.0	–	–	–	–	–	–	–	–
	T9315	2.4	█ 105	0.85	11.0	–	–	–	█ 95	0.85	11.0	–	–	–	–	–	–	–	–
	T9335	2.4	█ 80	0.85	11.0	█ 45	0.77	11.0	–	–	–	–	–	–	–	–	–	–	–
SNMM 250932-HR2	T9315	3.2	█ 95	1.00	11.0	–	–	–	█ 90	1.00	11.0	–	–	–	–	–	–	–	–
	T9335	3.2	█ 75	1.00	11.0	█ 45	0.90	11.0	–	–	–	–	–	–	–	–	–	–	–
				NR geometria per operazioni da semi sgrossatura fino a sgrossatura, da taglio continuo a interrotto.															
SNMM 120408E-NR	T7325	0.8	█ 185	0.40	3.0	█ 140	0.36	3.0	–	–	–	█ 60	0.28	2.4	–	–	–	–	–
	T7335	0.8	█ 175	0.40	3.0	█ 135	0.36	3.0	–	–	–	█ 55	0.28	2.4	–	–	–	–	–
	T8330	0.8	█ 160	0.40	3.0	█ 95	0.36	3.0	█ 150	0.40	3.0	–	–	–	█ 40	0.28	2.4	–	–
	T8430	0.8	█ 170	0.40	3.0	█ 90	0.36	3.0	█ 135	0.40	3.0	–	–	–	█ 35	0.28	2.4	–	–
	T9325	0.8	█ 205	0.40	3.0	█ 120	0.36	3.0	█ 190	0.40	3.0	–	–	–	█ 45	0.28	2.4	–	–
				NR2 geometria per operazioni da semi sgrossatura fino a sgrossatura, da taglio continuo a interrotto.															
SNMM 120408E-NR2	T7325	0.8	█ 175	0.40	4.7	█ 135	0.36	4.7	–	–	–	█ 55	0.32	3.8	–	–	–	–	–
	T7335	0.8	█ 170	0.40	4.7	█ 130	0.36	4.7	–	–	–	█ 55	0.32	3.8	–	–	–	–	–
	T8330	0.8	█ 155	0.40	4.7	█ 90	0.36	4.7	█ 145	0.40	4.7	–	–	–	█ 35	0.32	3.8	–	–
	T8430	0.8	█ 165	0.40	4.7	█ 90	0.36	4.7	█ 135	0.40	4.7	–	–	–	█ 35	0.32	3.8	–	–
	T9325	0.8	█ 195	0.40	4.7	█ 115	0.36	4.7	█ 185	0.40	4.7	–	–	–	█ 40	0.32	3.8	–	–
SNMM 120412E-NR2	T7335	1.2	█ 165	0.45	4.7	█ 125	0.41	4.7	–	–	–	█ 50	0.36	3.8	–	–	–	–	–
	T8330	1.2	█ 160	0.45	4.7	█ 95	0.41	4.7	█ 150	0.45	4.7	–	–	–	█ 40	0.36	3.8	–	–
	T8430	1.2	█ 165	0.45	4.7	█ 90	0.41	4.7	█ 135	0.45	4.7	–	–	–	█ 35	0.36	3.8	–	–
	T9325	1.2	█ 200	0.45	4.7	█ 120	0.41	4.7	█ 190	0.45	4.7	–	–	–	█ 45	0.36	3.8	–	–
SNMM 150612E-NR2	T7325	1.2	█ 170	0.45	6.0	█ 130	0.41	6.0	–	–	–	█ 55	0.36	4.8	–	–	–	–	–
	T7335	1.2	█ 165	0.45	6.0	█ 125	0.41	6.0	–	–	–	█ 50	0.36	4.8	–	–	–	–	–
	T8330	1.2	█ 155	0.45	6.0	█ 90	0.41	6.0	█ 145	0.45	6.0	–	–	–	█ 35	0.36	4.8	–	–
	T8430	1.2	█ 165	0.45	6.0	█ 90	0.41	6.0	█ 135	0.45	6.0	–	–	–	█ 35	0.36	4.8	–	–
	T9325	1.2	█ 195	0.45	6.0	█ 115	0.41	6.0	█ 185	0.45	6.0	–	–	–	█ 40	0.36	4.8	–	–
SNMM 150616E-NR2	T7335	1.6	█ 165	0.50	6.0	█ 125	0.45	6.0	–	–	–	█ 50	0.40	4.8	–	–	–	–	–
	T9325	1.6	█ 190	0.50	6.0	█ 110	0.45	6.0	█ 180	0.50	6.0	–	–	–	█ 40	0.40	4.8	–	–
SNMM 190612E-NR2	T7335	1.2	█ 160	0.45	8.0	█ 120	0.41	8.0	–	–	–	█ 50	0.36	6.4	–	–	–	–	–
	T9325	1.2	█ 190	0.45	8.0	█ 110	0.41	8.0	█ 180	0.45	8.0	–	–	–	█ 40	0.36	6.4	–	–
SNMM 190616E-NR2	T7325	1.6	█ 175	0.50	8.0	█ 135	0.45	8.0	–	–	–	█ 55	0.40	6.4	–	–	–	–	–
	T7335	1.6	█ 160	0.50	8.0	█ 120	0.45	8.0	–	–	–	█ 50	0.40	6.4	–	–	–	–	–
	T8330	1.6	█ 155	0.50	8.0	█ 90	0.45	8.0	█ 145	0.50	8.0	–	–	–	█ 35	0.40	6.4	–	–
	T8430	1.6	█ 155	0.50	8.0	█ 85	0.45	8.0	█ 130	0.50	8.0	–	–	–	█ 30	0.40	6.4	–	–
	T9315	1.6	█ 210	0.50	8.0	–	–	–	█ 195	0.50	8.0	–	–	–	–	–	–	–	–
	T9325	1.6	█ 185	0.50	8.0	█ 110	0.45	8.0	█ 175	0.50	8.0	–	–	–	█ 40	0.40	6.4	–	–
SNMM 190624E-NR2	T7325	2.4	█ 155	0.80	8.0	█ 120	0.72	8.0	–	–	–	█ 50	0.56	6.4	–	–	–	–	–
	T7335	2.4	█ 145	0.80	8.0	█ 110	0.72	8.0	–	–	–	█ 45	0.56	6.4	–	–	–	–	–
	T9325	2.4	█ 165	0.80	8.0	█ 95	0.72	8.0	█ 155	0.80	8.0	–	–	–	█ 35	0.56	6.4	–	–



Idoneità e valori iniziali per velocità di taglio (Vc), avanzamento (f) e profondità di taglio (ap). Fare riferimento alla nostra App Machining Calculator per ulteriori calcoli.

Codice prodotto	RE (mm)	P			M			K			N			S			H		
		vc (m/min)	f (mm/rev)	ap (mm)	vc (m/min)	f (mm/rev)	ap (mm)	vc (m/min)	f (mm/rev)	ap (mm)	vc (m/min)	f (mm/rev)	ap (mm)	vc (m/min)	f (mm/rev)	ap (mm)	vc (m/min)	f (mm/rev)	ap (mm)

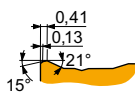

NR2 geometria per operazioni da semi sgrossatura fino a sgrossatura, da taglio continuo a interrotto.

SNMM 250724E-NR2	T7335	2.4	100	0.80	12.0	75	0.72	12.0	-	-	-	-	-	-	30	0.56	9.6	-	-	-
	T8330	2.4	85	0.80	12.0	50	0.72	12.0	80	0.80	12.0	-	-	-	20	0.56	9.6	-	-	-
	T8430	2.4	85	0.80	12.0	45	0.72	12.0	70	0.80	12.0	-	-	-	15	0.56	9.6	-	-	-
	T9226	2.4	95	0.80	12.0	55	0.72	12.0	90	0.80	12.0	-	-	-	20	0.56	9.6	-	-	-
	T9315	2.4	120	0.80	12.0	-	-	-	110	0.80	12.0	-	-	-	-	-	-	-	-	-
SNMM 250924E-NR2	T9325	2.4	105	0.80	12.0	60	0.72	12.0	95	0.80	12.0	-	-	-	20	0.56	9.6	-	-	-
	T7325	2.4	105	0.80	12.0	80	0.72	12.0	-	-	-	-	-	-	30	0.56	9.6	-	-	-
	T7335	2.4	100	0.80	12.0	75	0.72	12.0	-	-	-	-	-	-	30	0.56	9.6	-	-	-
	T9226	2.4	95	0.80	12.0	55	0.72	12.0	90	0.80	12.0	-	-	-	20	0.56	9.6	-	-	-
	T9315	2.4	120	0.80	12.0	-	-	-	110	0.80	12.0	-	-	-	-	-	-	-	-	-
T9325	2.4	105	0.80	12.0	60	0.72	12.0	95	0.80	12.0	-	-	-	20	0.56	9.6	-	-	-	-

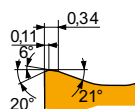

NRM geometria con design positivo per operazioni da semi sgrossatura fino a sgrossatura, da taglio continuo a moderatamente interrotto.

SNMM 250716-NRM	T7325	1.6	115	0.45	9.0	85	0.41	9.0	-	-	-	-	-	-	35	0.36	7.2	-	-	-
	T7335	1.6	110	0.45	9.0	85	0.41	9.0	-	-	-	-	-	-	35	0.36	7.2	-	-	-
	T9315	1.6	135	0.45	9.0	-	-	-	125	0.45	9.0	-	-	-	-	-	-	-	-	-
SNMM 250724-NRM	T7325	2.4	105	0.65	9.0	80	0.59	9.0	-	-	-	-	-	-	30	0.46	7.2	-	-	-
	T7335	2.4	100	0.65	9.0	75	0.59	9.0	-	-	-	-	-	-	30	0.46	7.2	-	-	-
	T9315	2.4	120	0.65	9.0	-	-	-	110	0.65	9.0	-	-	-	-	-	-	-	-	-
SNMM 250924-NRM	T7325	2.4	105	0.70	9.0	80	0.63	9.0	-	-	-	-	-	-	30	0.49	7.2	-	-	-
	T7335	2.4	95	0.70	9.0	70	0.63	9.0	-	-	-	-	-	-	30	0.49	7.2	-	-	-
	T9315	2.4	120	0.70	9.0	-	-	-	110	0.70	9.0	-	-	-	-	-	-	-	-	-

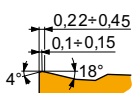

OR geometria per operazioni da semi sgrossatura fino a sgrossatura, da taglio continuo a interrotto.

SNMM 120408E-OR	T9315	0.8	220	0.40	4.7	-	-	-	205	0.40	4.7	-	-	-	-	-	-	-	-	-
	T9325	0.8	195	0.40	4.7	115	0.36	4.7	185	0.40	4.7	-	-	-	40	0.32	3.8	-	-	-
	T9335	0.8	175	0.40	4.7	105	0.36	4.7	-	-	-	-	-	-	35	0.32	3.8	-	-	-
SNMM 120412E-OR	T9315	1.2	225	0.45	4.7	-	-	-	210	0.45	4.7	-	-	-	-	-	-	-	-	-
	T9325	1.2	200	0.45	4.7	120	0.41	4.7	190	0.45	4.7	-	-	-	45	0.36	3.8	-	-	-
SNMM 120416E-OR	T9325	1.6	200	0.50	4.7	120	0.45	4.7	190	0.50	4.7	-	-	-	45	0.40	3.8	-	-	-
SNMM 150608E-OR	T9325	0.8	185	0.45	6.0	110	0.41	6.0	175	0.45	6.0	-	-	-	40	0.41	4.8	-	-	-
	T9335	0.8	170	0.40	6.0	100	0.36	6.0	-	-	-	-	-	-	35	0.36	4.8	-	-	-
SNMM 150612E-OR	T9325	1.2	195	0.45	6.0	115	0.41	6.0	185	0.45	6.0	-	-	-	40	0.36	4.8	-	-	-
	T9335	1.2	165	0.45	6.0	95	0.41	6.0	-	-	-	-	-	-	35	0.36	4.8	-	-	-
SNMM 150616E-OR	T9315	1.6	215	0.50	6.0	-	-	-	200	0.50	6.0	-	-	-	-	-	-	-	-	-
	T9325	1.6	190	0.50	6.0	110	0.45	6.0	180	0.50	6.0	-	-	-	40	0.40	4.8	-	-	-
SNMM 190612E-OR	T8330	1.2	150	0.45	8.0	90	0.41	8.0	140	0.45	8.0	-	-	-	35	0.36	6.4	-	-	-
	T8430	1.2	150	0.45	8.0	80	0.41	8.0	125	0.45	8.0	-	-	-	30	0.36	6.4	-	-	-
	T9315	1.2	210	0.45	8.0	-	-	-	195	0.45	8.0	-	-	-	-	-	-	-	-	-
	T9325	1.2	190	0.45	8.0	110	0.41	8.0	180	0.45	8.0	-	-	-	40	0.36	6.4	-	-	-
	T9335	1.2	165	0.45	8.0	95	0.41	8.0	-	-	-	-	-	-	35	0.36	6.4	-	-	-
SNMM 190616E-OR	T8330	1.6	155	0.50	8.0	90	0.45	8.0	145	0.50	8.0	-	-	-	35	0.40	6.4	-	-	-
	T8345	1.6	125	0.50	8.0	75	0.45	8.0	115	0.50	8.0	-	-	-	30	0.40	6.4	-	-	-
	T8430	1.6	155	0.50	8.0	85	0.45	8.0	130	0.50	8.0	-	-	-	30	0.40	6.4	-	-	-
	T9315	1.6	210	0.50	8.0	-	-	-	195	0.50	8.0	-	-	-	-	-	-	-	-	-
	T9325	1.6	185	0.50	8.0	110	0.45	8.0	175	0.50	8.0	-	-	-	40	0.40	6.4	-	-	-
SNMM 190624E-OR	T9335	1.6	160	0.50	8.0	95	0.45	8.0	-	-	-	-	-	-	35	0.40	6.4	-	-	-
	T9315	2.4	180	0.80	8.0	-	-	-	170	0.80	8.0	-	-	-	-	-	-	-	-	-
	T9325	2.4	165	0.80	8.0	95	0.72	8.0	155	0.80	8.0	-	-	-	35	0.56	6.4	-	-	-
SNMM 250716E-OR	T9226	1.6	115	0.50	12.0	65	0.45	12.0	105	0.50	12.0	-	-	-	20	0.45	9.6	-	-	-
	T9325	1.6	120	0.55	12.0	70	0.50	12.0	110	0.55	12.0	-	-	-	25	0.50	9.6	-	-	-



Idoneità e valori iniziali per velocità di taglio (Vc), avanzamento (f) e profondità di taglio (ap). Fare riferimento alla nostra App Machining Calculator per ulteriori calcoli.

Codice prodotto	RE (mm)	P			M			K			N			S			H		
		vc (m/min)	f (mm/rev)	ap (mm)	vc (m/min)	f (mm/rev)	ap (mm)	vc (m/min)	f (mm/rev)	ap (mm)	vc (m/min)	f (mm/rev)	ap (mm)	vc (m/min)	f (mm/rev)	ap (mm)	vc (m/min)	f (mm/rev)	ap (mm)

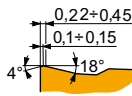

OR geometria per operazioni da semi sgrossatura fino a sgrossatura, da taglio continuo a interrotto.

SNMM 250724E-OR	T8330	2.4	80	1.00	12.0	45	0.90	12.0	75	1.00	12.0	—	—	—	20	0.70	9.6	—	—	—	
	T8345	2.4	55	1.00	12.0	30	0.90	12.0	50	1.00	12.0	—	—	—	10	0.70	9.6	—	—	—	
	T8430	2.4	80	1.00	12.0	45	0.90	12.0	65	1.00	12.0	—	—	—	15	0.70	9.6	—	—	—	
	T9315	2.4	105	1.00	12.0	—	—	—	95	1.00	12.0	—	—	—	—	—	—	—	—	—	—
	T9325	2.4	100	1.00	12.0	60	0.90	12.0	95	1.00	12.0	—	—	—	20	0.70	9.6	—	—	—	
SNMM 250924E-OR	T9335	2.4	80	1.00	12.0	45	0.90	12.0	—	—	—	—	—	—	15	0.70	9.6	—	—	—	
	T8430	2.4	80	1.00	12.0	45	0.90	12.0	65	1.00	12.0	—	—	—	15	0.70	9.6	—	—	—	
	T9226	2.4	85	1.00	12.0	50	0.90	12.0	80	1.00	12.0	—	—	—	15	0.70	9.6	—	—	—	
	T9315	2.4	105	1.00	12.0	—	—	—	95	1.00	12.0	—	—	—	—	—	—	—	—	—	—
	T9325	2.4	100	1.00	12.0	60	0.90	12.0	95	1.00	12.0	—	—	—	20	0.70	9.6	—	—	—	
T9335	2.4	80	1.00	12.0	45	0.90	12.0	—	—	—	—	—	—	15	0.70	9.6	—	—	—		

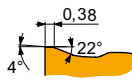

OR1 geometria per operazioni da semi sgrossatura fino a sgrossatura pesante, da taglio continuo a interrotto.

SNMM 190616E-OR1	T9325	1.6	185	0.50	8.0	110	0.45	8.0	175	0.50	8.0	—	—	—	40	0.35	6.4	—	—	—
	T9335	1.6	160	0.50	8.0	95	0.45	8.0	—	—	—	—	—	—	35	0.35	6.4	—	—	—

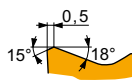

SR geometria adatta per operazioni da sgrossatura fino a sgrossatura pesante, da taglio continuo a interrotto.

SNMM 250724S-SR	6640	2.4	60	1.00	12.0	35	0.90	12.0	55	1.00	12.0	—	—	—	—	—	—	—	—	—
	T9226	2.4	70	1.00	12.0	40	0.90	12.0	65	1.00	12.0	—	—	—	—	—	—	—	—	—
	T9325	2.4	80	1.00	12.0	45	0.90	12.0	75	1.00	12.0	—	—	—	—	—	—	—	—	—
SNMM 250924S-SR	T9335	2.4	65	1.00	14.0	35	0.90	14.0	—	—	—	—	—	—	—	—	—	—	—	—

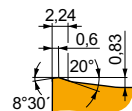

923 geometria per operazioni da semi sgrossatura fino a sgrossatura pesante, da taglio continuo a fortemente interrotto.

SNMM 190616S-923	T8330	1.6	125	0.65	8.9	75	0.59	8.9	115	0.65	8.9	—	—	—	30	0.52	7.1	—	—	—
	T8345	1.6	100	0.65	8.9	60	0.59	8.9	95	0.65	8.9	—	—	—	25	0.52	7.1	—	—	—
	T8430	1.6	125	0.65	8.9	65	0.59	8.9	100	0.65	8.9	—	—	—	25	0.52	7.1	—	—	—
	T9335	1.6	130	0.65	8.9	75	0.59	8.9	—	—	—	—	—	—	25	0.52	7.1	—	—	—
SNMM 250724S-923	T8330	2.4	80	0.85	11.0	45	0.77	11.0	75	0.85	11.0	—	—	—	20	0.60	8.8	—	—	—
	T8430	2.4	80	0.85	11.0	45	0.77	11.0	65	0.85	11.0	—	—	—	15	0.60	8.8	—	—	—
	T9335	2.4	80	0.85	11.0	45	0.77	11.0	—	—	—	—	—	—	15	0.60	8.8	—	—	—
SNMM 250924S-923	T8345	2.4	55	0.85	11.0	30	0.77	11.0	50	0.85	11.0	—	—	—	10	0.60	8.8	—	—	—
	T8430	2.4	80	0.85	11.0	45	0.77	11.0	65	0.85	11.0	—	—	—	15	0.60	8.8	—	—	—
	T9226	2.4	85	0.85	11.0	50	0.77	11.0	80	0.85	11.0	—	—	—	15	0.60	8.8	—	—	—
	T9315	2.4	105	0.85	11.0	—	—	—	95	0.85	11.0	—	—	—	—	—	—	—	—	—
T9335	2.4	80	0.85	11.0	45	0.77	11.0	—	—	—	—	—	—	15	0.60	8.8	—	—	—	
SNMM 250932S-923	T9226	3.2	80	1.00	11.0	45	0.90	11.0	75	1.00	11.0	—	—	—	15	0.70	8.8	—	—	—



SNMX

	IC	D1	L	S
	(mm)	(mm)	(mm)	(mm)
2512	25.400	9.17	25.40	12.00

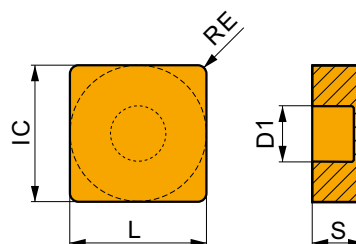

Idoneità e valori iniziali per velocità di taglio (Vc), avanzamento (f) e profondità di taglio (ap). Fare riferimento alla nostra App Machining Calculator per ulteriori calcoli.

Codice prodotto	RE	P			M			K			N			S			H		
		vc	f	ap	vc	f	ap	vc	f	ap	vc	f	ap	vc	f	ap	vc	f	ap
	(mm)	(m/min)	(mm/rev)	(mm)	(m/min)	(mm/rev)	(mm)	(m/min)	(mm/rev)	(mm)	(m/min)	(mm/rev)	(mm)	(m/min)	(mm/rev)	(mm)	(m/min)	(mm/rev)	(mm)

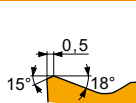

SR geometria adatta per operazioni da sgrossatura fino a sgrossatura pesante, da taglio continuo a interrotto.

SNMX 2512245-SR	T8345	2.4	45	1.00	14.0	25	0.90	14.0	40	1.00	14.0	-	-	-	-	-	-	-	-
	T9325	2.4	80	1.00	14.0	45	0.90	14.0	75	1.00	14.0	-	-	-	-	-	-	-	-
	T9335	2.4	65	1.00	14.0	35	0.90	14.0	-	-	-	-	-	-	-	-	-	-	-

SNGA CER

	IC	D1	L	S
	(mm)	(mm)	(mm)	(mm)
1204	12.700	5.16	12.70	4.76

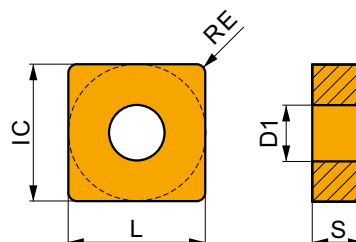

Idoneità e valori iniziali per velocità di taglio (Vc), avanzamento (f) e profondità di taglio (ap). Fare riferimento alla nostra App Machining Calculator per ulteriori calcoli.

Codice prodotto	RE	P			M			K			N			S			H		
		vc	f	ap	vc	f	ap	vc	f	ap	vc	f	ap	vc	f	ap	vc	f	ap
	(mm)	(m/min)	(mm/rev)	(mm)	(m/min)	(mm/rev)	(mm)	(m/min)	(mm/rev)	(mm)	(m/min)	(mm/rev)	(mm)	(m/min)	(mm/rev)	(mm)	(m/min)	(mm/rev)	(mm)

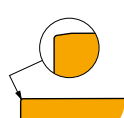

Adatta per lavorazioni con elevata velocità e taglio continuo.

SNGA 120408 T01025	TC100	0.8	-	-	-	-	-	-	575	0.20	2.0	-	-	-	-	-	-	-	-
SNGA 120412 T01020	TC100	1.2	-	-	-	-	-	-	565	0.25	2.0	-	-	-	-	-	-	-	-



SNGN CER

	IC (mm)	L (mm)	S (mm)
0903	9.525	9.525	3.18
1204	12.700	12.70	4.76
1207	12.700	12.70	7.94

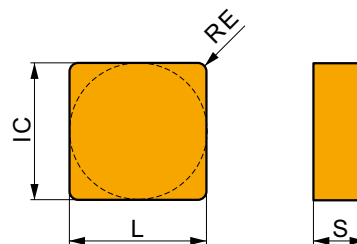

Idoneità e valori iniziali per velocità di taglio (V_c), avanzamento (f) e profondità di taglio (a_p). Fare riferimento alla nostra App Machining Calculator per ulteriori calcoli.

Codice prodotto	RE (mm)	P			M			K			N			S			H		
		v_c (m/min)	f (mm/rev)	a_p (mm)	v_c (m/min)	f (mm/rev)	a_p (mm)	v_c (m/min)	f (mm/rev)	a_p (mm)	v_c (m/min)	f (mm/rev)	a_p (mm)	v_c (m/min)	f (mm/rev)	a_p (mm)	v_c (m/min)	f (mm/rev)	a_p (mm)

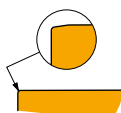

Adatta per lavorazioni con elevata velocità e taglio continuo.

SNGN 090308 T01020	TC100	0.8	-	-	-	-	-	-	☑	580	0.20	1.8	-	-	-	-	-	-	-
SNGN 090312 T01020	TC100	1.2	-	-	-	-	-	-	☑	565	0.25	1.8	-	-	-	-	-	-	-
SNGN 120404 T01020	TC100	0.4	-	-	-	-	-	-	☑	620	0.10	2.0	-	-	-	-	-	-	-
SNGN 120408 T01020	TC100	0.8	-	-	-	-	-	-	☑	575	0.20	2.0	-	-	-	-	-	-	-
SNGN 120708 T01020	TC100	0.8	-	-	-	-	-	-	☑	575	0.20	2.0	-	-	-	-	-	-	-
SNGN 120712 T01020	TC100	1.2	-	-	-	-	-	-	☑	565	0.25	2.0	-	-	-	-	-	-	-



DSBN(RL) EXT



Utensile esterno, doppio bloccaggio, angolo del tagliente utensile 75°, inserti SN..

Utensile di tornitura esterno, destro / sinistro, doppio bloccaggio a staffa con angolo del tagliente dell'utensile 75°. Adatto per tornitura longitudinale senza spallamento, tornitura conica e smussi con inserti negativi SN .. 12, 15 o 19. Disponibile con stelo da 20x20 a 40x40 mm. Corpo trattato per una maggiore durata dell'utensile.

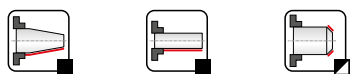
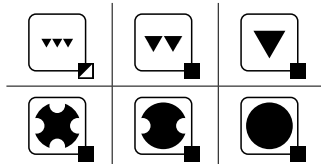
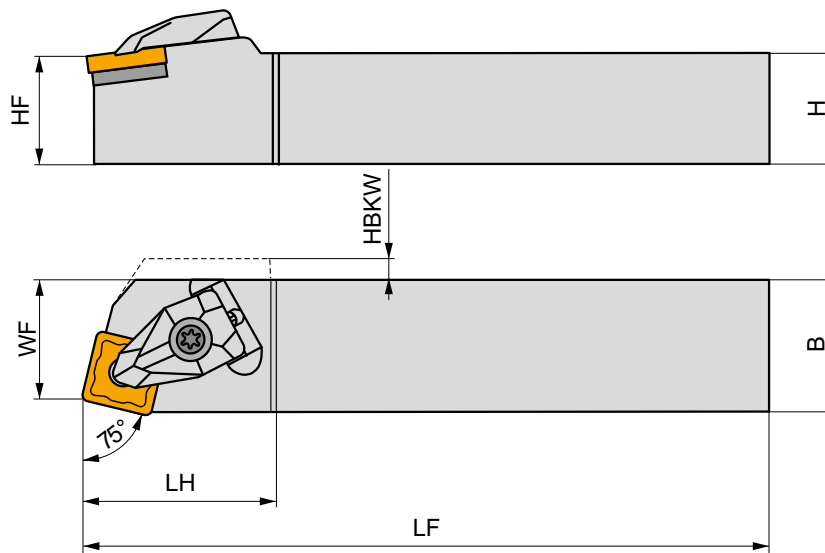
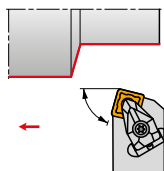

Codice prodotto	H	B	HF	WF	LF	LH	HBKW	LAMS	GAMO	kg				
	(mm)	(mm)	(mm)	(mm)	(mm)	(mm)	(mm)	(°)	(°)					
R	DSBNR 2020 K 12	20	20	20	17	125	34.2	2.5	-6	-6	0.43	GI029	DS12	AT003
	DSBNR 2525 M 12	25	25	25	22	150	34.3	-	-6	-6	0.74	GI029	DS12	AT003
	DSBNR 2525 M 15	25	25	25	22	150	41.6	2	-6	-6	0.80	GI082	DS15	AT006
	DSBNR 3225 P 15	32	25	32	22	170	41.7	2	-6	-6	1.07	GI082	DS15	AT006
	DSBNR 3232 P 19	32	32	32	27	170	46.4	-	-6	-6	1.38	GI026	DS19	-
DSBNR 4040 S 19	40	40	40	35	250	46.5	-	-6	-6	3.18	GI026	DS19	-	
L	DSBNL 2525 M 12	25	25	25	22	150	34.3	-	-6	-6	0.74	GI029	DS12	AT003
	DSBNL 2525 M 15	25	25	25	22	150	41.6	2	-6	-6	0.80	GI082	DS15	AT006
	DSBNL 3225 P 15	32	25	32	22	170	41.7	2	-6	-6	1.16	GI082	DS15	AT006
	DSBNL 3232 P 19	32	32	32	27	170	46.4	-	-6	-6	1.38	GI026	DS19	-
	DSBNL 4040 S 19	40	40	40	35	250	46.5	-	-6	-6	3.18	GI026	DS19	-



GI026

SN.. 1906..

GI029

SN.. 1204..

GI082

SN.. 1506..



DS12

DCS 12

3.9

DSS 425-01

US 2002-T15P

FLAG T15P/3,5

-

DS15

DCS 16

6.4

DSS 425-03

US 2007-T20P

-

LKT20P

DS19

DCS 19

6.4





DSS 425-04

US 2007-T20P

-

LKT20P



			
AT003a	SN.. 1207..	-	DSS 425-02
AT006a	SN.. 1507..	-	DSS 425-05
AT003b	CER SN.N 1204..	DCS 12C4	-
AT003c	CER SN.A 1204..	DCS 12C2	-
AT006b	CER CN.N 1606..	DCS 16C4	-
AT006c	CER CN.A 1606..	DCS 16C2	-



DSDNN EXT



PRAMET

D



Utensile esterno, doppio bloccaggio, angolo del tagliente utensile 45°, inserti SN..

Utensile esterno di tornitura, neutro, doppio bloccaggio a staffa con angolo del tagliente utensile 45°. Adatto per tornitura longitudinale senza spallamento, copiatura, tornitura conica e smussi con inserti negativi SN .. 12, 15, 19 o 25. Disponibile con stelo da 25x25 a 40x40 mm. Corpo trattato per una maggiore durata dell'utensile.

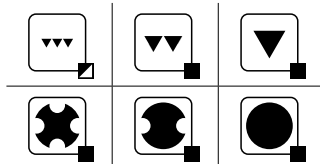
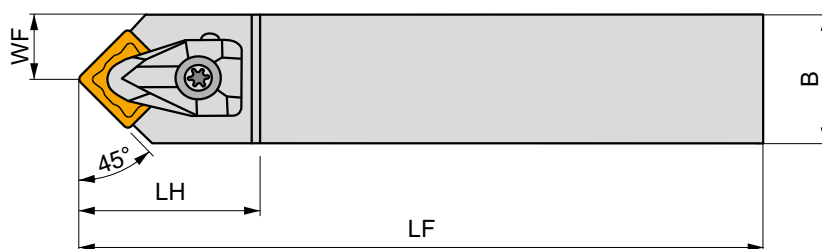
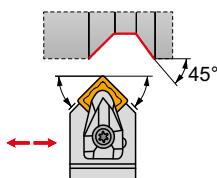

Codice prodotto	H	B	HF	WF	LF	LH	LAMS	GAMO	kg	GI	DS	AT
	(mm)	(mm)	(mm)	(mm)	(mm)	(mm)	(°)	(°)				
N DSDNN 2525 M 12	25	25	25	12.8	150	36.5	-6	-6	0.74	GI029	DS12	AT003
DSDNN 2525 M 15	25	25	25	12.8	150	44.8	-6	-6	0.76	GI082	DS15	AT006
DSDNN 3232 P 19	32	32	32	16.5	170	49.5	-6	-6	1.36	GI026	DS19	-
DSDNN 4040 S 25	40	40	40	21	250	57.2	-6	-6	3.13	GI027	DS25	-

GI	SN..
GI026	SN.. 1906..
GI027	SN.. 2507..
GI029	SN.. 1204..
GI082	SN.. 1506..

DS	DCS	Nm	DSS	US	FLAG	LKT
DS12	DCS 12	3.9	DSS 425-01	US 2002-T15P	FLAG T15P/3,5	-
DS15	DCS 16	6.4	DSS 425-03	US 2007-T20P	-	LKT20P
DS19	DCS 19	6.4	DSS 425-04	US 2007-T20P	-	LKT20P
DS25	DCS 25	9.5	DSS 425-07	US 2008-T25P	-	LKT25P

AT	SN..	DCS	DSS
AT003a	SN.. 1207..	-	DSS 425-02
AT006a	SN.. 1507..	-	DSS 425-05
AT003b	CER SN.N 1204..	DCS 12C4	-
AT003c	CER SN.A 1204..	DCS 12C2	-
AT006b	CER CN.N 1606..	DCS 16C4	-
AT006c	CER CN.A 1606..	DCS 16C2	-



DSKN(RL) EXT



Utensile esterno, doppio bloccaggio, angolo del tagliente utensile 75° (sfacciare), inserti SN..

Utensile esterno di tornitura, destro / sinistro, doppio bloccaggio a staffa con angolo del tagliente dell'utensile 75°. Adatto per sfacciare senza spallamento e smussare con inserti SN .. 12 .. o 19 ... Disponibile con stelo da 25x25 a 32x32 mm. Corpo trattato per una maggiore durata dell'utensile.

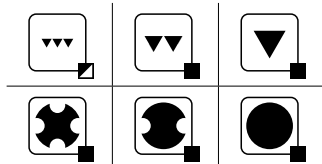
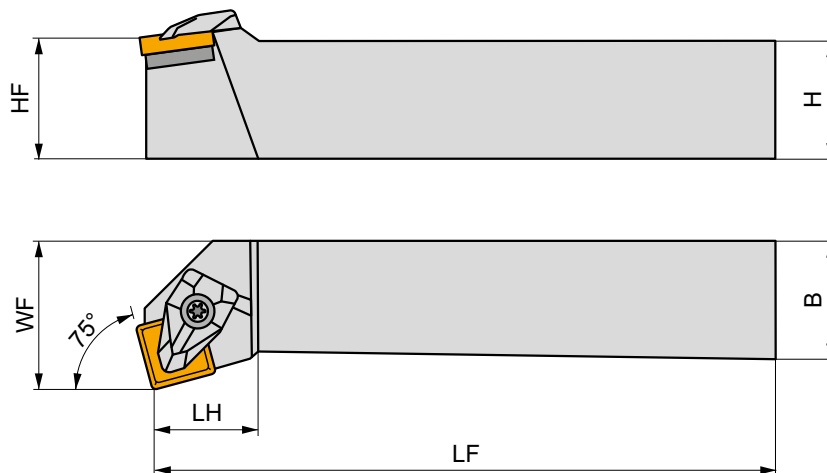
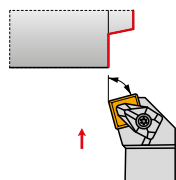

Codice prodotto	H	B	HF	WF	LF	LH	LAMS	GAMO	kg			
	(mm)	(mm)	(mm)	(mm)	(mm)	(mm)	(°)	(°)				
R DSKNR 2525 M 12	25	25	25	32	150	23.6	-6	-6	0.79	G1029	DS12	AT003
DSKNR 3232 P 19	32	32	32	40	170	32.1	-6	-6	1.46	G1026	DS19	-
L DSKNL 2525 M 12	25	25	25	32	150	23.6	-6	-6	0.79	G1029	DS12	AT003
DSKNL 3232 P 19	32	32	32	40	170	32.1	-6	-6	1.46	G1026	DS19	-

G1026	SN.. 1906..
G1029	SN.. 1204..

DS12	DCS 12	3.9	DSS 425-01	US 2002-T15P	FLAG T15P/3,5	-
DS19	DCS 19	6.4	DSS 425-04	US 2007-T20P	-	LK T20P

AT003a	SN.. 1207..	-	DSS 425-02
AT003b	CER SN.N 1204..	DCS 12C4	-
AT003c	CER SN.A 1204..	DCS 12C2	-



DSSN(RL) EXT



Utensile esterno, doppio bloccaggio, angolo del tagliente utensile 45°, inserti SN..

Utensile esterno di tornitura, destro / sinistro, doppio bloccaggio a staffa, con angolo del tagliente dell'utensile 45°. Adatto per tornitura longitudinale e sfacciatura senza spallamento, conica, a copiare e smussatura con inserti negativi SN .. 12, 15 o 19. Disponibile con stelo da 20x20 a 40x40 mm. Corpo trattato per una maggiore durata dell'utensile.

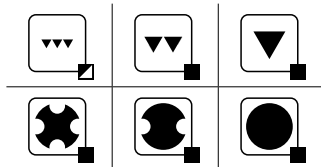
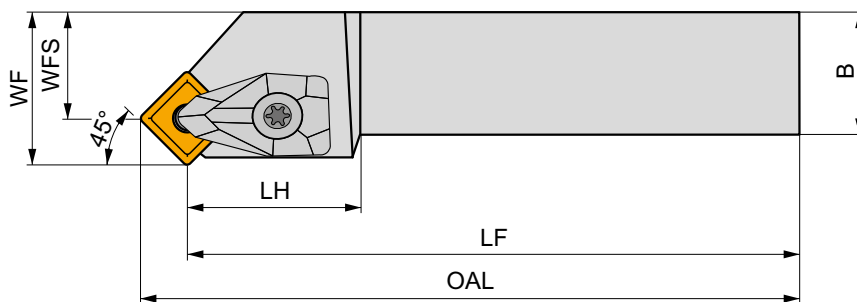
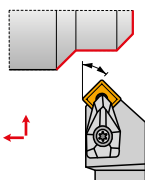

Codice prodotto		H	B	HF	WF	WFS	LF	OAL	LH	LAMS	GAMO	kg			
		(mm)	(mm)	(mm)	(mm)	(mm)	(mm)	(mm)	(mm)	(°)	(°)				
R	DSSNR 2020 K 12	20	20	20	25	16.7	125	133.3	27.5	0	-8	0.45	GI029	DS12	AT003
	DSSNR 2525 M 12	25	25	25	32	23.7	150	158.3	27.5	0	-8	0.80	GI029	DS12	AT003
	DSSNR 2525 M 15	25	25	25	32	21.8	150	160.2	32	0	-8	0.83	GI082	DS15	AT006
	DSSNR 3225 P 15	32	25	32	32	21.8	170	180.2	34.9	0	-8	1.16	GI082	DS15	AT006
	DSSNR 3232 P 19	32	32	32	40	27.5	170	182.5	37	0	-8	1.48	GI026	DS19	-
	DSSNR 4040 S 19	40	40	40	50	37.5	250	262.5	37.7	0	-8	3.27	GI026	DS19	-
L	DSSNL 2020 K 12	20	20	20	25	16.7	125	133.3	27.5	0	-8	0.45	GI029	DS12	AT003
	DSSNL 2525 M 12	25	25	25	32	23.7	150	158.3	27.5	0	-8	0.19	GI029	DS12	AT003
	DSSNL 2525 M 15	25	25	25	32	21.8	150	160.2	32	0	-8	0.83	GI082	DS15	AT006
	DSSNL 3225 P 15	32	25	32	32	21.8	170	180.2	34.9	0	-8	1.16	GI082	DS15	AT006
	DSSNL 3232 P 19	32	32	32	40	27.5	170	182.5	37	0	-8	1.48	GI026	DS19	-
	DSSNL 4040 S 19	40	40	40	50	37.5	250	262.5	37.7	0	-8	3.27	GI026	DS19	-



GI026
GI029
GI082

SN.. 1906..
SN.. 1204..
SN.. 1506..



DS12
DS15
DS19

DCS 12
DCS 16
DCS 19

3.9
6.4
6.4

DSS 425-01
DSS 425-03
DSS 425-04

US 2002-T15P
US 2007-T20P
US 2007-T20P

FLAG T15P/3,5
-
-

-
LKT20P
LKT20P



AT003a
AT006a
AT003b
AT003c
AT006b
AT006c

SN.. 1207..
SN.. 1507..
CER SN.N 1204..
CER SN.A 1204..
CER CN.N 1606..
CER CN.A 1606..

-
-
DCS 12C4
DCS 12C2
DCS 16C4
DCS 16C2

DSS 425-02
DSS 425-05
-
-
-
-



PSBN(RL) EXT



PRAMET

P



Utensile esterno, bloccaggio a leva, angolo del tagliente utensile 75°, inserti SN..

Utensile di tornitura esterno destro / sinistro, bloccaggio a leva, con angolo del tagliente di 75°. Adatto per tornitura longitudinale senza spallamento, tornitura conica e smussatura con inserti negativi SN .. 12, 15, 19 o 25. Disponibile con steli da 20x20 a 50x50 mm. Corpo trattato per una maggiore durata dell'utensile.

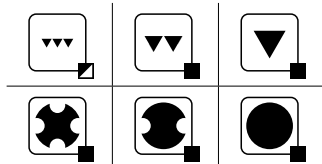
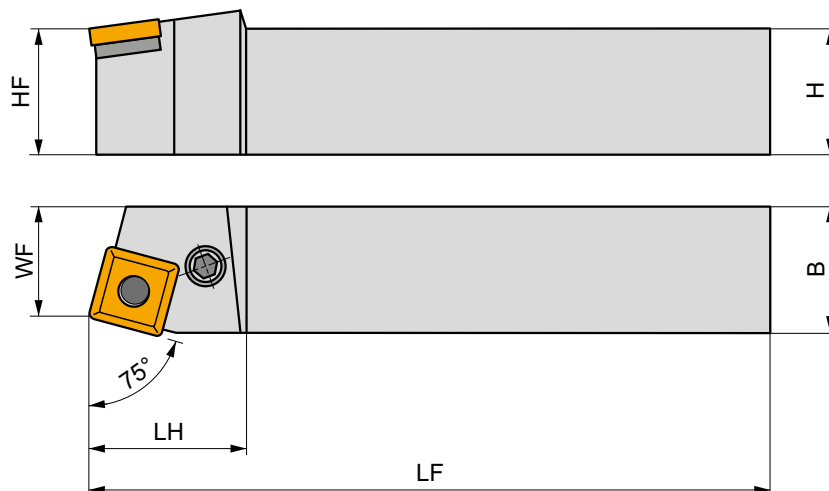
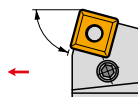
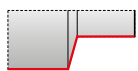

Codice prodotto	∅	B	HF	WF	LF	LH	LAMS	GAMO	kg		
	(mm)	(mm)	(mm)	(mm)	(mm)	(mm)	(°)	(°)			
R PSBNR 2020 K 12	20	20	20	17	125	36	-6	-6	0.43	G1029	PS22
PSBNR 2525 M 12	25	25	25	22	150	36	-6	-6	0.75	G1029	PS20
PSBNR 3225 P 15	32	25	32	22	170	40	-6	-6	1.05	G1082	PS40
PSBNR 3232 P 19	32	32	32	27	170	45	-6	-6	1.30	G1026	PS50
PSBNR 4040 R 19	40	40	40	35	200	45	-6	-6	2.40	G1026	PS50
PSBNR 4040 S 19	40	40	40	35	250	45	-6	-6	3.12	G1026	PS50
PSBNR 4040 R 25	40	40	40	35	200	45	-6	-6	2.45	G1027	PS60
PSBNR 4040 S 25	40	40	40	35	250	50	-6	-6	2.85	G1027	PS60
PSBNR 4040 S 2509	40	40	40	35	250	50	-6	-6	2.50	G1040	PS70
PSBNR 4040 S 2512-A	40	40	40	35	250	50	-6	-6	3.08	G1162	PS72
PSBNR 5050 S 25	50	50	50	43	250	50	-6	-6	4.70	G1027	PS60
PSBNR 5050 T 25	50	50	50	43	300	50	-6	-6	5.83	G1027	PS60
PSBNR 5050 T 2509	50	50	50	43	300	50	-6	-6	5.50	G1040	PS70
PSBNR 5050 T 2512-A	50	50	50	43	300	50	-6	-6	5.83	G1162	PS72
L PSBNL 2020 K 12	20	20	20	17	125	36	-6	-6	0.42	G1029	PS22
PSBNL 2525 M 12	25	25	25	22	150	36	-6	-6	0.75	G1029	PS20
PSBNL 3225 P 15	32	25	32	22	170	40	-6	-6	1.05	G1082	PS40
PSBNL 3232 P 19	32	32	32	27	170	45	-6	-6	1.36	G1026	PS50
PSBNL 4040 R 19	40	40	40	35	200	45	-6	-6	2.50	G1026	PS50
PSBNL 4040 S 19	40	40	40	35	250	45	-6	-6	3.13	G1026	PS50
PSBNL 4040 R 25	40	40	40	35	200	45	-6	-6	2.45	G1027	PS60
PSBNL 4040 S 25	40	40	40	35	250	50	-6	-6	3.10	G1027	PS60
PSBNL 4040 S 2509	40	40	40	35	250	50	-6	-6	2.50	G1040	PS70
PSBNL 4040 S 2512-A	40	40	40	35	250	50	-6	-6	3.11	G1162	PS72
PSBNL 5050 S 25	50	50	50	43	250	50	-6	-6	4.70	G1027	PS60
PSBNL 5050 T 25	50	50	50	43	300	50	-6	-6	5.84	G1027	PS60
PSBNL 5050 T 2509	50	50	50	43	300	50	-6	-6	5.80	G1040	PS70



Codice prodotto	H	B	HF	WF	LF	LH	LAMS	GAMO			
	(mm)	(mm)	(mm)	(mm)	(mm)	(mm)	(°)	(°)			
L PSBNL 5050 T 2512-A	50	50	50	43	300	50	-6	-6	5.82	G162	PS72

GI026	SN.. 1906..
GI027	SN.. 2507..
GI029	SN.. 1204..
GI040	SN.. 2509..
GI082	SN.. 1506..
GI162	SN.. 2512..

PS20	SNU 120312	PU 02	US 35	6.0	M 8x1	22.5	NT 05	MT 05	HXK 4
PS22	SNU 120312	PU 02	US 42	6.0	M 8x1	21	NT 05	MT 05	HXK 4
PS40	SNU 150312	PU 04	US 36	6.0	M 8x1	26	NT 07	MT 07	HXK 4
PS50	SNU 190416	PU 05	US 38	8.0	M 10x1	29	NT 06	MT 06	HXK 5
PS60	SNU 250624	PU 06	US 39	8.0	M 10x1	33	NT 08	MT 08	HXK 5
PS70	SNU 250624	PU 06	US 47	8.0	M 12x1	36	NT 08	MT 08	HXK 5
PS72	SNU 250624	PU 10-N	PS 12040	8.0	M 12x1	40	NT 08	MT 08	HXK 5



PSDNN EXT



PRAMET

P



Utensile esterno, bloccaggio a leva, angolo del tagliente utensile 45°, inserti SN..

Utensile esterno neutro di tornitura con bloccaggio a leva, angolo del tagliente utensile 45°. Adatto per tornitura longitudinale senza spallamento, tornitura a copiare, conica e smussatura con inserti negativi SN .. 12, 15, 19 o 25. Disponibile con stelo da 20x20 a 50x50 mm. Corpo trattato per una maggiore durata dell'utensile.

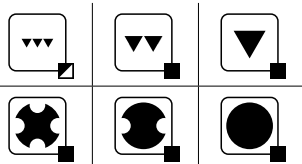
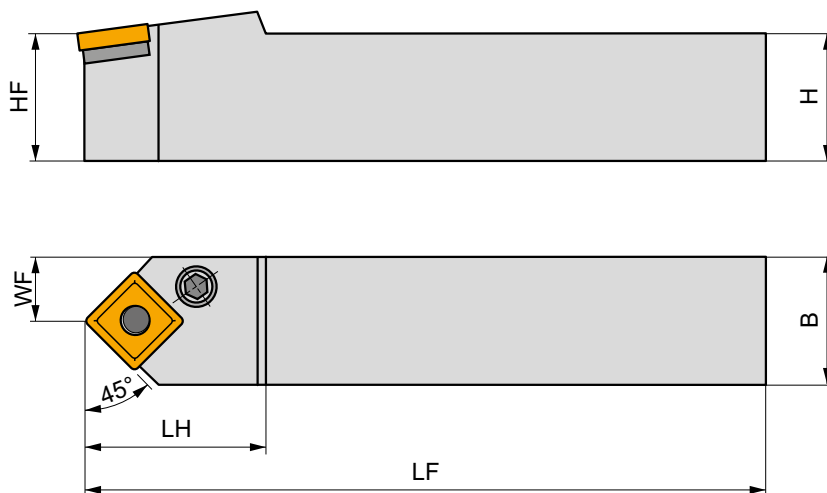
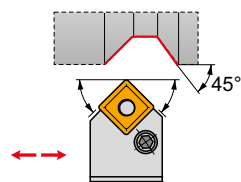

Codice prodotto	H	B	HF	WF	LF	LH	LAMS	GAMO	kg		
	(mm)	(mm)	(mm)	(mm)	(mm)	(mm)	(°)	(°)			
PSDNN 2020 K 12	20	20	20	10	125	36	-6	-6	0.42	GI029	PS22
PSDNN 2525 M 12	25	25	25	12.5	150	36	-6	-6	0.68	GI029	PS20
PSDNN 3232 P 15	32	32	32	16	170	40	-6	-6	1.32	GI082	PS40
PSDNN 3232 P 19	32	32	32	16	170	45	-6	-6	1.25	GI026	PS50
PSDNN 4040 S 19	40	40	40	20	250	45	-6	-6	3.05	GI026	PS50
PSDNN 4040 S 25	40	40	40	20	250	50	-6	-6	3.02	GI027	PS60
PSDNN 5050 T 25	50	50	50	25	300	50	-6	-6	5.65	GI027	PS60



GI026	SN.. 1906..
GI027	SN.. 2507..
GI029	SN.. 1204..
GI082	SN.. 1506..



PS20	SNU 120312	PU 02	US 35	6.0	M 8x1	22.5	NT 05	MT 05	HXX 4
PS22	SNU 120312	PU 02	US 42	6.0	M 8x1	21	NT 05	MT 05	HXX 4
PS40	SNU 150312	PU 04	US 36	6.0	M 8x1	26	NT 07	MT 07	HXX 4
PS50	SNU 190416	PU 05	US 38	8.0	M 10x1	29	NT 06	MT 06	HXX 5
PS60	SNU 250624	PU 06	US 39	8.0	M 10x1	33	NT 08	MT 08	HXX 5



PSKN(RL) EXT

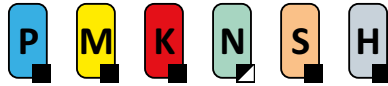

PRAMET

P



Utensile esterno, bloccaggio a leva, angolo del tagliente utensile 75° (sfacciare), inserti SN..

Utensile di tornitura esterno destro / sinistro, bloccaggio a leva, con angolo del tagliente utensile di 75°. Adatto per sfacciatura senza spallamento e smussatura con inserti negativi SN .. 12, 15, 19 o 25. Disponibile con steli da 20x20 a 50x50 mm. Corpo trattato per una maggiore durata dell'utensile.

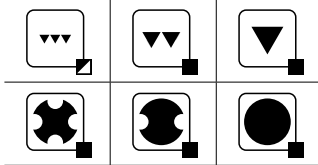
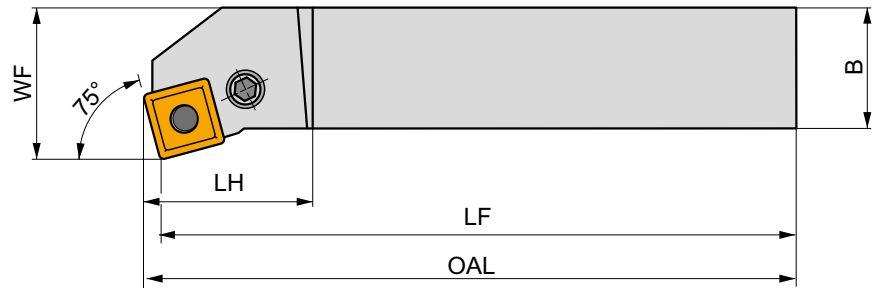
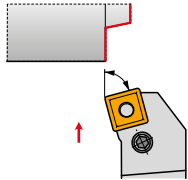

Codice prodotto	H	B	HF	WF	LF	OAL	LH	LAMS	GAMO	kg	GI029	PS22	
	(mm)	(mm)	(mm)	(mm)	(mm)	(mm)	(mm)	(°)	(°)				
R	PSKNR 2020 K 12	20	20	20	25	125	128.1	36	-6	-6	0.43	GI029	PS22
	PSKNR 2525 M 12	25	25	25	32	150	153.1	36	-6	-6	0.79	GI029	PS20
	PSKNR 3225 P 15	32	25	32	32	170	173.9	40	-6	-6	0.40	GI082	PS40
	PSKNR 3232 P 19	32	32	32	40	170	174.6	45	-6	-6	1.40	GI026	PS50
	PSKNR 4040 S 19	40	40	40	50	250	254.6	45	-6	-6	3.25	GI026	PS50
	PSKNR 4040 S 25	40	40	40	50	250	256.5	50	-6	-6	3.40	GI027	PS60
	PSKNR 5050 T 25	50	50	50	60	300	306.5	50	-6	-6	6.05	GI027	PS60
	PSKNR 5050 T 2509	50	50	50	60	300	306.5	50	-6	-6	6.20	GI040	PS70
L	PSKNL 2020 K 12	20	20	20	25	125	128.1	36	-6	-6	0.43	GI029	PS22
	PSKNL 2525 M 12	25	25	25	32	150	153.1	36	-6	-6	0.79	GI029	PS20
	PSKNL 3225 P 15	32	25	32	32	170	173.9	40	-6	-6	1.05	GI082	PS40
	PSKNL 3232 P 19	32	32	32	40	170	174.6	45	-6	-6	1.40	GI026	PS50
	PSKNL 4040 S 19	40	40	40	50	250	254.6	45	-6	-6	3.26	GI026	PS50
	PSKNL 4040 S 25	40	40	40	50	250	256.5	50	-6	-6	3.40	GI027	PS60
	PSKNL 5050 T 25	50	50	50	60	300	306.5	50	-6	-6	6.00	GI027	PS60
	PSKNL 5050 T 2509	50	50	50	60	300	306.5	50	-6	-6	6.20	GI040	PS70



GI026

SN.. 1906..

GI027

SN.. 2507..

GI029

SN.. 1204..











GI040

SN.. 2509..

GI082

SN.. 1506..



				 Nm					
PS20	SNU 120312	PU 02	US 35	6.0	M 8x1	22.5	NT 05	MT 05	HXX 4
PS22	SNU 120312	PU 02	US 42	6.0	M 8x1	21	NT 05	MT 05	HXX 4
PS40	SNU 150312	PU 04	US 36	6.0	M 8x1	26	NT 07	MT 07	HXX 4
PS50	SNU 190416	PU 05	US 38	8.0	M 10x1	29	NT 06	MT 06	HXX 5
PS60	SNU 250624	PU 06	US 39	8.0	M 10x1	33	NT 08	MT 08	HXX 5
PS70	SNU 250624	PU 06	US 47	8.0	M 12x1	36	NT 08	MT 08	HXX 5



PSSN(RL) EXT



Utensile esterno, bloccaggio a leva, angolo del tagliente utensile 45°, inserti SN..

Utensile di tornitura esterno destro / sinistro, bloccaggio a leva con angolo del tagliente utensile di 45°. Adatto per tornitura longitudinale e sfacciatura senza spallamento, tornitura a copiare, conica e smussatura, con inserti negativi SN .. 12, 15, 19 o 25. Disponibile con steli da 20x20 a 50x50 mm. Corpo trattato per una maggiore durata dell'utensile.

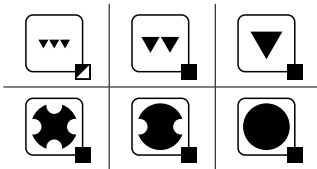
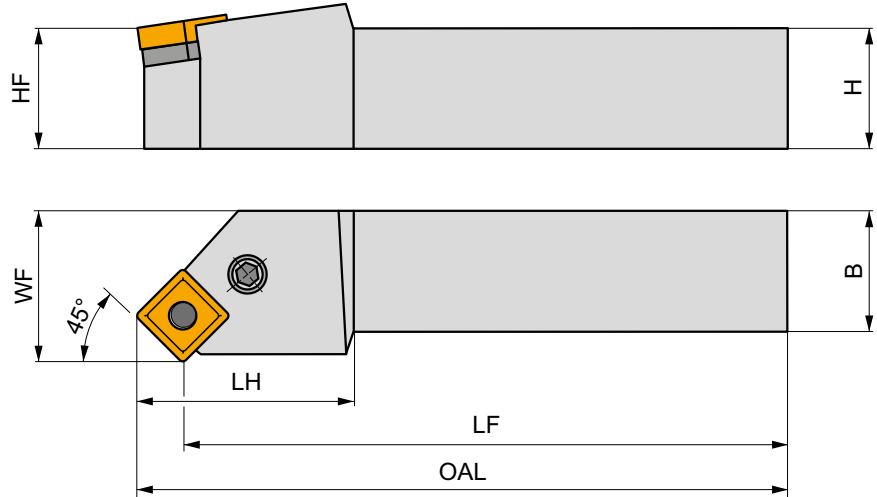
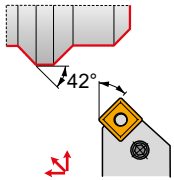

Codice prodotto	H	B	HF	WF	LF	OAL	LH	LAMS	GAMO	kg			
	(mm)	(mm)	(mm)	(mm)	(mm)	(mm)	(mm)	(°)	(°)				
R	PSSNR 2020 K 12	20	20	20	25	125	133.3	36	0	-8	0.41	GI029	PS22
	PSSNR 2525 M 12	25	25	25	32	150	158.3	36	0	-8	0.75	GI029	PS20
	PSSNR 3225 P 15	32	25	32	32	170	180.2	40	0	-8	1.13	GI082	PS40
	PSSNR 3232 P 19	32	32	32	40	170	182.5	45	0	-8	1.34	GI026	PS50
	PSSNR 4040 R 19	40	40	40	50	200	212.5	45	0	-8	2.50	GI026	PS50
	PSSNR 5050 T 25	50	50	50	60	300	316	50	0	-8	6.00	GI027	PS60
PSSNR 5050 T 2509	50	50	50	60	300	316	50	0	-8	6.05	GI040	PS70	
L	PSSNL 2020 K 12	20	20	20	25	125	133.3	36	0	-8	0.41	GI029	PS22
	PSSNL 2525 M 12	25	25	25	32	150	158.3	36	0	-8	0.67	GI029	PS20
	PSSNL 3225 P 15	32	25	32	32	170	180.2	40	0	-8	1.15	GI082	PS40
	PSSNL 3232 P 19	32	32	32	40	170	182.5	45	0	-8	1.44	GI026	PS50
	PSSNL 4040 R 19	40	40	40	50	200	212.5	45	0	-8	2.58	GI026	PS50
	PSSNL 5050 T 25	50	50	50	60	300	316	50	0	-8	6.00	GI027	PS60
PSSNL 5050 T 2509	50	50	50	60	300	316	50	0	-8	6.08	GI040	PS70	



GI026	SN.. 1906..
GI027	SN.. 2507..
GI029	SN.. 1204..
GI040	SN.. 2509..
GI082	SN.. 1506..



PS20	SNU 120312	PU 02	US 35	6.0	M 8x1	22.5	NT 05	MT 05	HXK 4
PS22	SNU 120312	PU 02	US 42	6.0	M 8x1	21	NT 05	MT 05	HXK 4
PS40	SNU 150312	PU 04	US 36	6.0	M 8x1	26	NT 07	MT 07	HXK 4
PS50	SNU 190416	PU 05	US 38	8.0	M 10x1	29	NT 06	MT 06	HXK 5
PS60	SNU 250624	PU 06	US 39	8.0	M 10x1	33	NT 08	MT 08	HXK 5
PS70	SNU 250624	PU 06	US 47	8.0	M 12x1	36	NT 08	MT 08	HXK 5

NEW
C.-DSDNN EXT

D

Utensile PSC a cambio rapido, doppio bloccaggio, angolo del tagliente utensile 45°, inserti SN..

Utensile esterno di tornitura, neutro, a doppio bloccaggio con staffa, forato per refrigerante interno, angolo del tagliente utensile 45°, per tornitura longitudinale senza spallamento, tornitura a copiare, tornitura conica e smussi, con inserti SN .. 12 o 19 negativi. Attacco a scambio rapido PSC (Polygon Shank Coupling) dimensioni da C4 a C6. Corpo trattato per una maggiore durata dell'utensile.

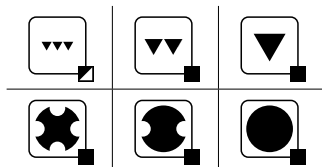
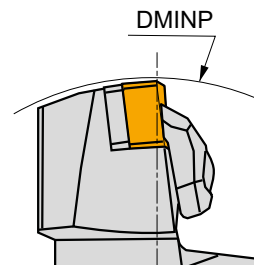
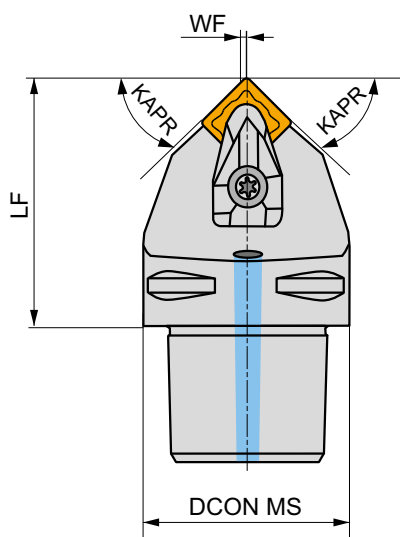
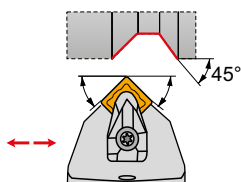

Codice prodotto	DCON MS (mm)	DMINP (mm)	WF (mm)	LF (mm)	KAPR (°)	LAMS (°)	GAMO (°)		kg			
N C4-DSDNN-00050-12	40	140	0.3	50	45	-6	-6	✓	0.39	GI029	C-DS12-2	AT003
C5-DSDNN-00060-12	50	165	0.3	60	45	-6	-6	✓	0.69	GI029	C-DS12-2	AT003
C6-DSDNN-00070-19	63	195	0.5	70	45	-6	-6	✓	1.28	GI026	C-DS19	-

GI026		SN.. 1906..	
GI029		SN.. 1204..	

C-DS12-2	DCS 12	3.9	DSS 425-01	US 2002-T15P	FLAG T15P/3,5	-	CN 045-01
C-DS19	DCS 19	6.4	DSS 425-04	US 2007-T20P	-	LKT20P	CN 045-01

AT003a	SN.. 1207..	-	DSS 425-02
AT003b	CER SN.N 1204..	DCS 12C4	-
AT003c	CER SN.A 1204..	DCS 12C2	-

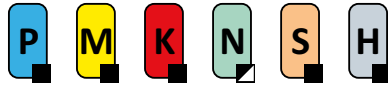
NEW
C.-DSKN(RL) EXT

D

Utensile est. PSC a cambio rapido, doppio bloccaggio, angolo del tagliente 75° (sfacciare), inserti SN..

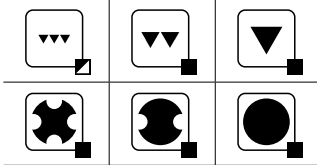
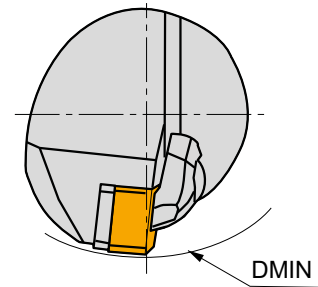
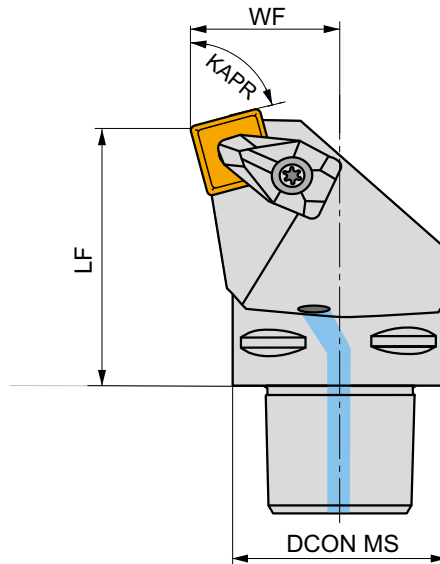
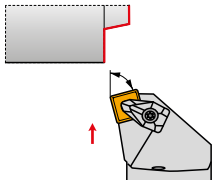
Utensile di tornitura esterno destro / sinistro, doppio bloccaggio a staffa e fori per refrigerante interno, angolo del tagliente di 75°. Per tornitura di sfacciatura senza spallamento e smussi con inserti negativi SN .. 12 .. Attacco a cambio rapido PSC (Polygon Shank Coupling) C4. Corpo trattato per una maggiore durata dell'utensile.



Codice prodotto	DCON MS (mm)	DMIN (mm)	WF (mm)	LF (mm)	KAPR (°)	LAMS (°)	GAMO (°)					
R C4-DSKNR-27050-12	40	110	27	50	75	-6	-6	✓	0.46	GI029	C-DS12-1	AT003
L C4-DSKNL-27050-12	40	110	27	50	75	-6	-6	✓	0.46	GI029	C-DS12-1	AT003



GI029



SN.. 1204..



C-DS12-1



DCS 12



3.9



DSS 425-01



US 2002-T15P



FLAG T15P/3,5



CN 034-01



AT003a



SN.. 1207..



-



DSS 425-02

AT003b

CER SN.N 1204..

DCS 12C4

AT003c

CER SN.A 1204..

DCS 12C2

-

NEW
C.-DSRN(RL) EXT

D

Utensile est. PSC a cambio rapido, doppio bloccaggio, angolo del tagliente utensile 75°, inserti SN..

Utensile di tornitura esterno destro / sinistro, doppio bloccaggio a staffa con fori per refrigerante, angolo del tagliente utensile 75°, per tornitura longitudinale senza spallamento, tornitura conica e smussatura con inserti SN .. 12 o 19. Attacco a cambio rapido PSC (Polygon Shank Coupling) da C4 a C6. Corpo trattato per una maggiore durata dell'utensile.

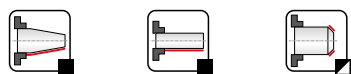
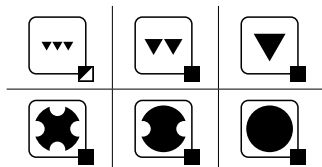
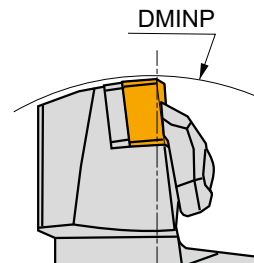
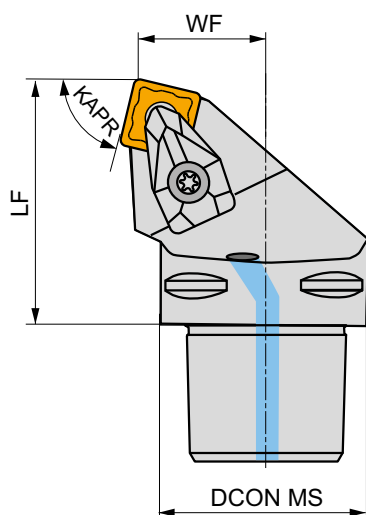
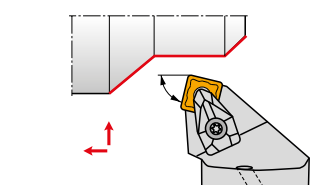

Codice prodotto	DCON MS	DMINP	WF	LF	KAPR	LAMS	GAMO					
	(mm)	(mm)	(mm)	(mm)	(°)	(°)	(°)					
R C4-DSRNR-22050-12	40	140	22	50	75	-6	-6	✓	0.40	GI029	C-DS12-1	AT003
	C6-DSRNR-35065-19	63	190	35	65	75	-6	-6	✓	1.30	GI026	C-DS19
L C4-DSRNL-22050-12	40	140	22	50	75	-6	-6	✓	0.42	GI029	C-DS12-1	AT003
	C6-DSRNL-35065-19	63	190	35	65	75	-6	-6	✓	1.30	GI026	C-DS19

GI026					SN.. 1906..		
GI029					SN.. 1204..		

C-DS12-1	DCS 12	3.9	DSS 425-01	US 2002-T15P	FLAG T15P/3,5	-	CN 034-01
C-DS19	DCS 19	6.4	DSS 425-04	US 2007-T20P	-	LK T20P	CN 045-01

AT003a	SN.. 1207..		-	DSS 425-02
AT003b	CER SN.N 1204..		DCS 12C4	-
AT003c	CER SN.A 1204..		DCS 12C2	-

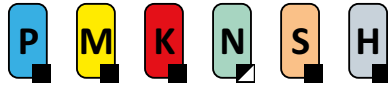
NEW
C.-DSSN(RL) EXT

D

Utensile est. PSC a cambio rapido, doppio bloccaggio, angolo del tagliente utensile 45°, inserti SN..

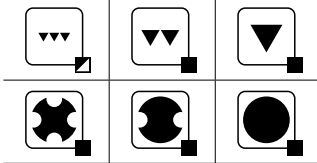
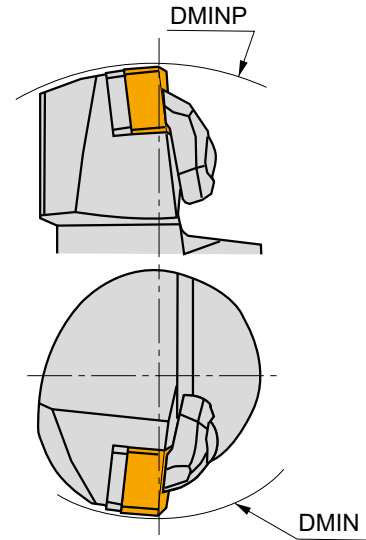
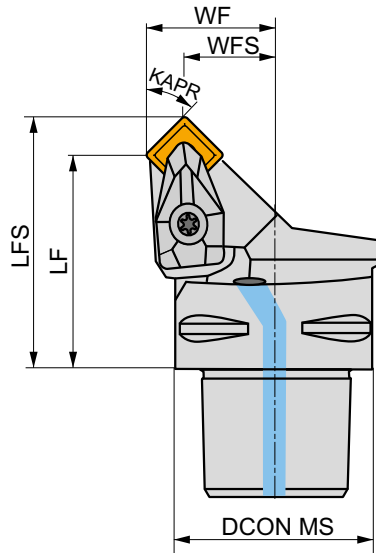
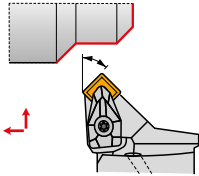
Utensile di tornitura esterno destro / sinistro, doppio bloccaggio a staffa con fori per refrigerante interno, angolo del tagliente utensile di 45°. Per tornitura longitudinale e sfacciatura senza spallamento, tornitura conica, tornitura a copiare e smussatura con inserto negativo SN .. 12. Attacco a cambio rapido PSC (Polygon Shank Coupling) dimensioni C4 e C5. Corpo trattato per una maggiore durata dell'utensile.



Codice prodotto	DCON MS	DMIN	DMINP	WF	WFS	LF	LFS	KAPR	LAMS	GAMO					
	(mm)	(mm)	(mm)	(mm)	(mm)	(mm)	(mm)	(°)	(°)	(°)					
R C4-DSSNR-27042-12	40	110	140	27	18.7	42	50.3	45	0	-8	✓	0.38	GI029	C-DS12-1	AT003
	C5-DSSNR-35052-12	50	110	165	35	26.7	52	60.3	45	0	-8	✓	0.68	GI029	C-DS12-3
L C4-DSSNL-27042-12	40	110	140	27	18.7	42	50.3	45	0	-8	✓	0.36	GI029	C-DS12-1	AT003
	C5-DSSNL-35052-12	50	110	165	35	26.7	52	60.3	45	0	-8	✓	0.69	GI029	C-DS12-3



GI029



SN.. 1204..



C-DS12-1



DCS 12



3.9



DSS 425-01



US 2002-T15P



FLAG T15P/3,5



CN 034-01

C-DS12-3

DCS 12

3.9

DSS 425-01

US 2002-T15P

FLAG T15P/3,5

CN 034-02



AT003a



SN.. 1207..



-



DSS 425-02

AT003b

CER SN.N 1204..

DCS 12C4

-

AT003c

CER SN.A 1204..

DCS 12C2

-



KHP-SBN(RL)



PRAMET

P



Cartuccia di tornitura KHP, bloccaggio a leva, angolo del tagliente utensile 75°, inserti SN..

Cartuccia a coda di rondine, destra/sinistra, bloccaggio a leva, angolo del tagliente utensile 75°, si monta su stelo utensili DKH. Adatta per tornitura longitudinale pesante senza spallamento, tornitura frontale, conica e smussi con inserti negativi SN..19 o 25. Utensile trattato per una maggiore durata.

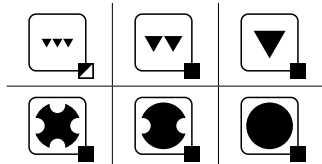
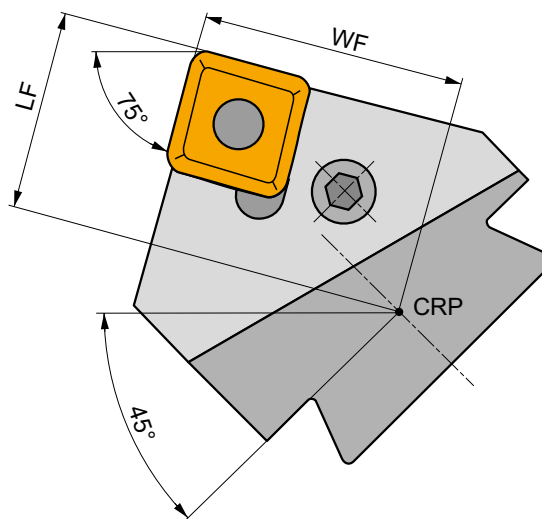
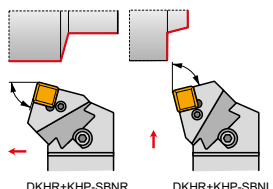

Codice prodotto	WF (mm)	LF (mm)	LAMS (°)	GAMO (°)	kg		
R KHP-SBNR 19	47	36	-6	-6	1.51	GI026	PS50
KHP-SBNR 25	47	36	-6	-6	1.47	GI027	PS60
KHP-SBNR 2509	47	36	-6	-6	1.45	GI040	PS70
KHP-SBNR 2512-A	47	36	-6	-6	1.71	GI162	PS72
L KHP-SBNL 19	47	36	-6	-6	1.96	GI026	PS50
KHP-SBNL 25	47	36	-6	-6	1.48	GI027	PS60
KHP-SBNL 2509	47	36	-6	-6	1.46	GI040	PS70
KHP-SBNL 2512-A	47	36	-6	-6	1.45	GI162	PS72

GI026	SN.. 1906..
GI027	SN.. 2507..
GI040	SN.. 2509..
GI162	SN.. 2512..

PS50	SNU 190416	PU 05	US 38	8.0	M 10x1	29	NT 06	MT 06	HXX 5
PS60	SNU 250624	PU 06	US 39	8.0	M 10x1	33	NT 08	MT 08	HXX 5
PS70	SNU 250624	PU 06	US 47	8.0	M 12x1	36	NT 08	MT 08	HXX 5
PS72	SNU 250624	PU 10-N	PS 12040	8.0	M 12x1	40	NT 08	MT 08	HXX 5



KHP-SSN(RL)



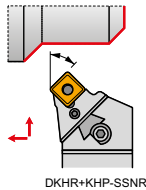

Cartuccia di tornitura KHP, bloccaggio a leva, angolo del tagliente utensile 45°, inserti SN..

Cartuccia a coda di rondine, destra/sinistra, bloccaggio a leva, angolo del tagliente utensile 45°, si monta su stelo utensili DKH. Adatta per tornitura longitudinale pesante senza spallamento, tornitura frontale, tornitura a copiare, conica e smussi con inserti negativi SN .. 19 o 25. Utensile trattato per una maggiore durata.

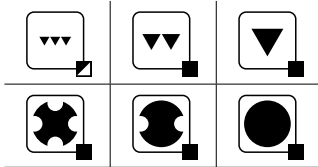
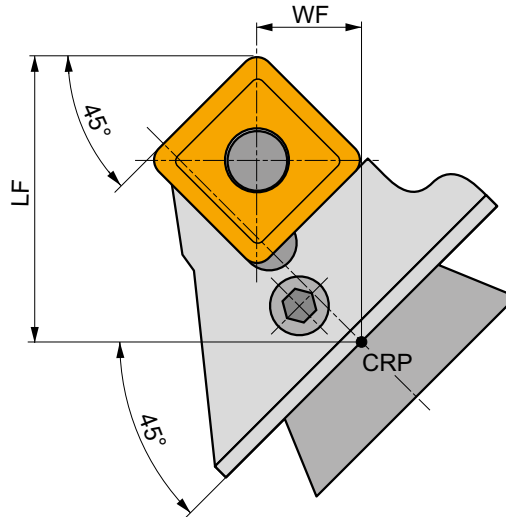

DKHR+KHP-SSNR



Codice prodotto	WF	LF	LAMS	GAMO	kg		
	(mm)	(mm)	(°)	(°)			
R KHP-SSNR 19	15	45	-6	-6	1.28	GI026	PS50
	KHP-SSNR 25	15	45	-6	-6	0.98	GI027
L KHP-SSNL 19	15	45	-6	-6	1.03	GI026	PS50
	KHP-SSNL 25	15	45	-6	-6	1.30	GI027

GI026	SN.. 1906..
GI027	SN.. 2507..

PS50	SNU 190416	PU 05	US 38	8.0	M 10x1	29	NT 06	MT 06	HXK 5
PS60	SNU 250624	PU 06	US 39	8.0	M 10x1	33	NT 08	MT 08	HXK 5



DKH(RL)



Stelo esterno per cartucce modulari KHP/KHS per tornitura pesante

Stelo modulare, destro/sinistro, a coda di rondine per cartucce KHP/KHS. Adatto per applicazioni di tornitura pesante. Dimensioni stelo 40x50 fino a 60x80mm. Corpo trattato per una durata maggiore dell'utensile.

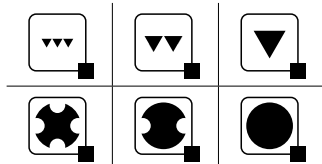
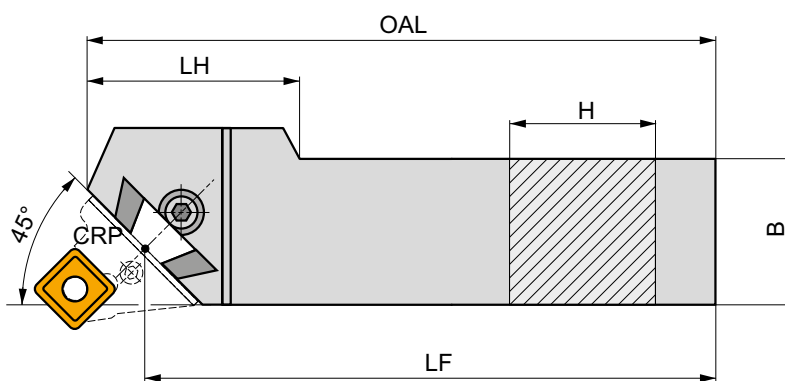
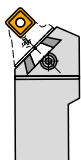

Codice prodotto	H	B	LF	OAL	LH	kg		
	(mm)	(mm)	(mm)	(mm)	(mm)			
R	DKHR 4050 V	40	50	400	425	7.10	GI098	DKH10
	DKHR 5060 W	50	60	450	475	11.30	GI098	DKH10
	DKHR 6080 W-A	60	80	450	485	19.65	GI098	DKH10
L	DKHL 4050 V	40	50	400	425	7.10	GI098	DKH10
	DKHL 5060 W	50	60	450	475	11.30	GI098	DKH10
	DKHL 6080 W-A	60	80	450	485	19.28	GI098	DKH10

GI098	KHP	KHS

DKH10	SR 14	HXK 10



PSKN(RL) INT



Utensile interno, bloccaggio a leva, inserti SN... angolo del tagliente utensile 75°

Bareno destro/sinistro per tornitura interna con bloccaggio a leva e passaggio refrigerante interno, angolo del tagliente utensile 75° per inserti negativi SN...12, 15 e 19. Diametro interno minimo tornibile Ø40 mm. Per operazioni di tornitura longitudinale, conicità e smussi. Disponibile con stelo da Ø32 mm fino a Ø60 mm. Corpo trattato per una maggiore durata.

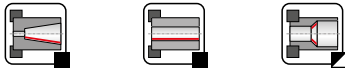
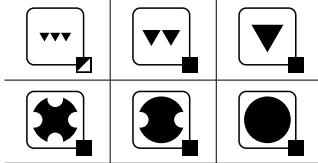
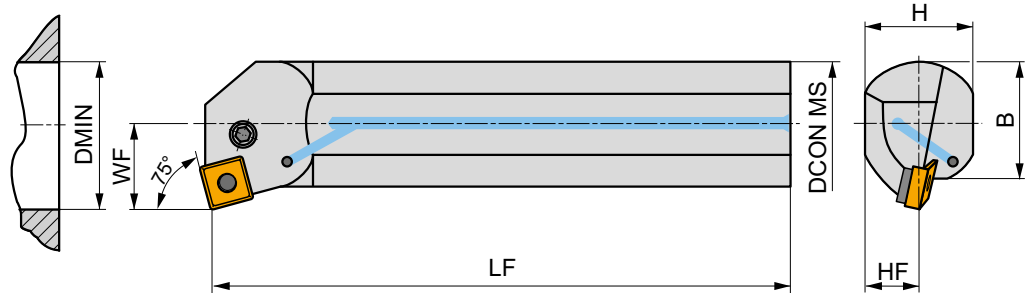
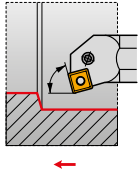

Codice prodotto	DCON MS	DMIN	WF	H	B	LF	LAMS	GAMO				
	(mm)	(mm)	(mm)	(mm)	(mm)	(mm)	(°)	(°)				
R A32S-PSKNR 12	32	40	22	30	30	250	-12	-6	✓	1.50	GI029	PS21
A40T-PSKNR 15	40	50	27	38	38	300	-12	-6	✓	2.90	GI082	PS41
A50U-PSKNR 15	50	63	35	47	48.5	350	-12	-6	✓	5.20	GI082	PS40
A50U-PSKNR 19	50	63	35	47	48.5	350	-12	-6	✓	5.20	GI026	PS50
A60V-PSKNR 19	60	80	43	57	58.5	400	-12	-6	✓	8.70	GI026	PS50
L A32S-PSKNL 12	32	40	22	30	30	250	-12	-6	✓	1.40	GI029	PS21
A40T-PSKNL 15	40	50	27	38	38	300	-12	-6	✓	2.90	GI082	PS41
A50U-PSKNL 15	50	63	35	47	48.5	350	-12	-6	✓	5.20	GI082	PS40
A50U-PSKNL 19	50	63	35	47	48.5	350	-12	-6	✓	5.20	GI026	PS50



GI026

SN.. 1906..

GI029

SN.. 1204..

GI082

SN.. 1506..



PS21

SNU 120312

PU 02

US 41

6.0

M 8x1

17

NT 05

MT 05

HXK 4

PS40

SNU 150312

PU 04

US 36

6.0

M 8x1

26

NT 07

MT 07

HXK 4

PS41

SNU 150312

PU 04

US 40

6.0

M 8x1

20.5

NT 07

MT 07

HXK 4

PS50

SNU 190416

PU 05

US 38

8.0

M 10x1

29

NT 06

MT 06

HXK 5



TN

16/ 22/ 27/ 33

INSERTI IN METALLO DURO

TNMA	TNMG	TNMM
334	335	342

INSERTI CER E CBN

TNGA CER	TNGN CER	TNGA CBN
343	344	344

ABBINAMENTO DELLA DIMENSIONE CORRETTA (esempio)

Inserto	Portainsero
TNMM 160412E-OR	DTFNR 2525 M 16

TORNITURA ISO - ESTERNA

DTFN(RL) EXT 90° ↑ 16 22 20×20 25×25 345 334 - 344	DTGN(RL) EXT 90° ← 16 22 20×20 32×25 346 334 - 344	MTJN(RL) EXT 93° ↗ 22° 16 22 16×16 32×32 347 334 - 344	PTFN(RL) EXT 90° ↑ 16 22 27 16×16 40×40 348 334 - 344
PTGN(RL) EXT 90° ← 16 22 27 16×16 40×40 349 334 - 344	PPTN(RL) EXT 60° ↘ 30° 16 22 20×20 32×25 350 334 - 344	C.-DTJN(RL) EXT NEW 93° ← 16 C4 C5 351 334 - 344	



TN

16/ 22/ 27/ 33

TORNITURA ISO INTERNA

DTFN(RL) INT		PTFN(RL) INT		C.-DTFN(RL) INT NEW	
90°	TN..	90°	TN..	91°	TN..
	16 22		16 22		16
	$\frac{32}{50}$		$\frac{32}{50}$		32
	352		353		354
	334 - 344		334 - 344		334 - 344



TNMA

	IC	D1	L	S
	(mm)	(mm)	(mm)	(mm)
1604	9.525	3.81	16.50	4.76
2204	12.700	5.16	22.00	4.76

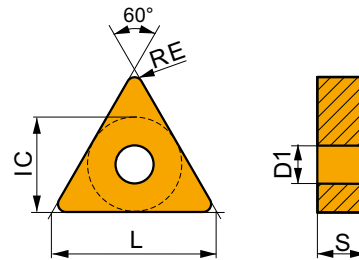

Idoneità e valori iniziali per velocità di taglio (Vc), avanzamento (f) e profondità di taglio (ap). Fare riferimento alla nostra App Machining Calculator per ulteriori calcoli.

Codice prodotto	RE	P			M			K			N			S			H		
		vc	f	ap	vc	f	ap	vc	f	ap	vc	f	ap	vc	f	ap	vc	f	ap
	(mm)	(m/min)	(mm/rev)	(mm)	(m/min)	(mm/rev)	(mm)	(m/min)	(mm/rev)	(mm)	(m/min)	(mm/rev)	(mm)	(m/min)	(mm/rev)	(mm)	(m/min)	(mm/rev)	(mm)

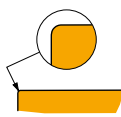

Adatta per operazioni da finitura fino a semi sgrossatura, da taglio continuo a leggermente interrotto.

TNMA 160404	T5305	0.4	-	-	-	-	-	-	220	0.10	1.5	-	-	-	-	-	-	45	0.15	1.0
	T5315	0.4	-	-	-	-	-	-	190	0.10	1.5	-	-	-	-	-	-	40	0.15	1.0
TNMA 160408	T5305	0.8	-	-	-	-	-	-	205	0.20	1.5	-	-	-	-	-	-	40	0.15	1.0
	T5315	0.8	-	-	-	-	-	-	180	0.20	1.5	-	-	-	-	-	-	35	0.15	1.0
	T6310	0.8	-	-	-	-	-	-	90	0.20	1.5	-	-	-	-	-	-	20	0.15	1.0
TNMA 160412	T5305	1.2	-	-	-	-	-	-	215	0.20	1.5	-	-	-	-	-	-	45	0.15	1.0
	T5315	1.2	-	-	-	-	-	-	190	0.20	1.5	-	-	-	-	-	-	40	0.15	1.0
TNMA 220408	T5305	0.8	-	-	-	-	-	-	195	0.20	2.0	-	-	-	-	-	-	40	0.15	1.0
	T5315	0.8	-	-	-	-	-	-	175	0.20	2.0	-	-	-	-	-	-	35	0.15	1.0
	T6310	0.8	-	-	-	-	-	-	90	0.20	2.0	-	-	-	-	-	-	20	0.15	1.0
TNMA 220412	T5305	1.2	-	-	-	-	-	-	205	0.20	2.0	-	-	-	-	-	-	40	0.15	1.0
	T5315	1.2	-	-	-	-	-	-	185	0.20	2.0	-	-	-	-	-	-	35	0.15	1.0

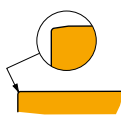

Adatta per operazioni da finitura fino a semi sgrossatura, da taglio continuo a leggermente interrotto.

TNMA 160408S	T5305	0.8	-	-	-	-	-	-	205	0.20	1.5	-	-	-	-	-	-	40	0.15	1.0
--------------	-------	-----	---	---	---	---	---	---	-----	------	-----	---	---	---	---	---	---	----	------	-----



TNMG



	IC	D1	L	S
	(mm)	(mm)	(mm)	(mm)
1604	9.525	3.81	16.50	4.76
2204	12.700	5.16	22.00	4.76
2706	15.875	6.35	27.50	6.35
3309	19.050	7.94	33.00	9.525

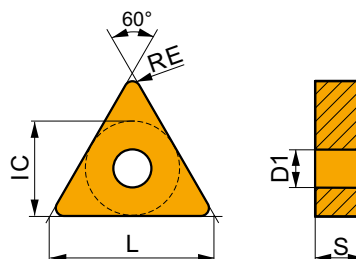

Idoneità e valori iniziali per velocità di taglio (Vc), avanzamento (f) e profondità di taglio (ap). Fare riferimento alla nostra App Machining Calculator per ulteriori calcoli.

Codice prodotto	RE	P			M			K			N			S			H		
		vc	f	ap	vc	f	ap	vc	f	ap	vc	f	ap	vc	f	ap	vc	f	ap
	(mm)	(m/min)	(mm/rev)	(mm)	(m/min)	(mm/rev)	(mm)	(m/min)	(mm/rev)	(mm)	(m/min)	(mm/rev)	(mm)	(m/min)	(mm/rev)	(mm)	(m/min)	(mm/rev)	(mm)

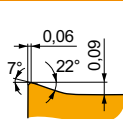

FF geometria altamente positiva per operazioni di super finitura, da taglio continuo a leggermente interrotto.

TNMG 160404E-FF	T7325	0.4	200	0.12	1.0	155	0.11	1.0	-	-	-	-	-	-	-	-	-	-	-
	T8315	0.4	185	0.12	1.0	110	0.11	1.0	175	0.12	1.0	-	-	-	-	-	-	-	-
	T8330	0.4	175	0.12	1.0	105	0.11	1.0	165	0.12	1.0	-	-	-	-	-	-	-	-
	T8430	0.4	210	0.12	1.0	115	0.11	1.0	175	0.12	1.0	-	-	-	-	-	-	-	-
TNMG 160408E-FF	T7325	0.8	225	0.15	1.0	175	0.14	1.0	-	-	-	-	-	-	-	-	-	-	-
	T8315	0.8	205	0.15	1.0	120	0.14	1.0	190	0.15	1.0	-	-	-	-	-	-	-	-

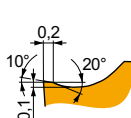

FM geometria positiva per operazioni da finitura fino a semi sgrassatura, da taglio continuo a leggermente interrotto.

TNMG 160404E-FM	T7325	0.4	160	0.20	1.7	120	0.18	1.7	-	-	-	50	0.20	1.4	-	-	-	-	-	
	T7335	0.4	160	0.20	1.7	120	0.18	1.7	-	-	-	50	0.20	1.4	-	-	-	-	-	
	T8315	0.4	150	0.20	1.7	90	0.18	1.7	140	0.20	1.7	35	0.14	1.4	-	-	-	-	-	
	T8330	0.4	145	0.20	1.7	85	0.18	1.7	135	0.20	1.7	35	0.14	1.4	-	-	-	-	-	
	T8430	0.4	165	0.20	1.7	90	0.18	1.7	135	0.20	1.7	35	0.14	1.4	-	-	-	-	-	
	T9310	0.4	245	0.20	1.7	-	-	-	230	0.20	1.7	-	-	-	-	-	-	-	-	-
	T9315	0.4	220	0.20	1.7	-	-	-	205	0.20	1.7	-	-	-	-	-	-	-	-	-
	T9325	0.4	200	0.20	1.7	120	0.18	1.7	190	0.20	1.7	45	0.20	1.4	-	-	-	-	-	
	TT310	0.4	225	0.20	1.7	135	0.18	1.7	-	-	-	-	-	-	-	-	-	-	-	
	TNMG 160408E-FM	T7325	0.8	195	0.20	1.7	150	0.18	1.7	-	-	-	60	0.16	1.4	-	-	-	-	-
T7335		0.8	190	0.20	1.7	145	0.18	1.7	-	-	-	60	0.16	1.4	-	-	-	-	-	
T8315		0.8	180	0.20	1.7	105	0.18	1.7	170	0.20	1.7	45	0.16	1.4	-	-	-	-	-	
T8330		0.8	170	0.20	1.7	100	0.18	1.7	160	0.20	1.7	40	0.16	1.4	-	-	-	-	-	
T8430		0.8	195	0.20	1.7	105	0.18	1.7	160	0.20	1.7	40	0.16	1.4	-	-	-	-	-	
T9310		0.8	290	0.20	1.7	-	-	-	275	0.20	1.7	-	-	-	-	-	-	-	-	
T9315		0.8	265	0.20	1.7	-	-	-	250	0.20	1.7	-	-	-	-	-	-	-	-	
T9325		0.8	235	0.20	1.7	140	0.18	1.7	220	0.20	1.7	50	0.16	1.4	-	-	-	-	-	
TT310		0.8	270	0.20	1.7	160	0.18	1.7	-	-	-	-	-	-	-	-	-	-	-	
TNMG 160412E-FM		T7325	1.2	190	0.25	1.7	145	0.23	1.7	-	-	-	60	0.18	1.4	-	-	-	-	-
	T8330	1.2	165	0.25	1.7	95	0.23	1.7	155	0.25	1.7	40	0.18	1.4	-	-	-	-	-	
	T8430	1.2	185	0.25	1.7	100	0.23	1.7	150	0.25	1.7	40	0.18	1.4	-	-	-	-	-	
	T9310	1.2	280	0.25	1.7	-	-	-	265	0.25	1.7	-	-	-	-	-	-	-	-	
	T9315	1.2	255	0.25	1.7	-	-	-	240	0.25	1.7	-	-	-	-	-	-	-	-	
	T9325	1.2	225	0.25	1.7	135	0.23	1.7	210	0.25	1.7	50	0.18	1.4	-	-	-	-	-	
TNMG 220404E-FM	T8330	0.4	145	0.20	1.7	85	0.18	1.7	135	0.20	1.7	35	0.20	1.4	-	-	-	-	-	
	T8430	0.4	150	0.24	1.7	80	0.22	1.7	125	0.24	1.7	30	0.22	1.4	-	-	-	-	-	
	T9315	0.4	220	0.20	1.7	-	-	-	205	0.20	1.7	-	-	-	-	-	-	-	-	
	T9325	0.4	200	0.20	1.7	120	0.18	1.7	190	0.20	1.7	45	0.20	1.4	-	-	-	-	-	



Idoneità e valori iniziali per velocità di taglio (Vc), avanzamento (f) e profondità di taglio (ap). Fare riferimento alla nostra App Machining Calculator per ulteriori calcoli.

Codice prodotto	RE  (mm)	P			M			K			N			S			H		
		vc (m/min)	f (mm/rev)	ap (mm)	vc (m/min)	f (mm/rev)	ap (mm)	vc (m/min)	f (mm/rev)	ap (mm)	vc (m/min)	f (mm/rev)	ap (mm)	vc (m/min)	f (mm/rev)	ap (mm)	vc (m/min)	f (mm/rev)	ap (mm)

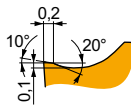

FM geometria positiva per operazioni da finitura fino a semi sgrossatura, da taglio continuo a leggermente interrotto.

TNMG 220408E-FM	T8330	0.8	170	0.20	1.7	100	0.18	1.7	160	0.20	1.7	—	—	—	40	0.16	1.4	—	—	—
	T8430	0.8	195	0.20	1.7	105	0.18	1.7	160	0.20	1.7	—	—	—	40	0.16	1.4	—	—	—
	T9315	0.8	265	0.20	1.7	—	—	—	250	0.20	1.7	—	—	—	—	—	—	—	—	—
	T9325	0.8	235	0.20	1.7	140	0.18	1.7	220	0.20	1.7	—	—	—	50	0.16	1.4	—	—	—

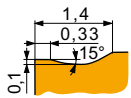

KR geometria per operazioni da semi sgrossatura fino a sgrossatura, da taglio continuo a interrotto.

TNMG 160408E-KR	T5305	0.8	220	0.35	3.0	—	—	—	205	0.35	3.0	—	—	—	—	—	—	40	0.15	1.0
	T5315	0.8	200	0.35	3.0	—	—	—	190	0.35	3.0	—	—	—	—	—	—	40	0.15	1.0

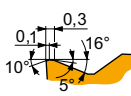

M geometria per operazioni da finitura fino a semi sgrossatura, da taglio continuo a interrotto.

TNMG 160404E-M	T5315	0.4	215	0.20	1.6	—	—	—	200	0.20	1.6	—	—	—	—	—	—	40	0.15	1.0
	T9315	0.4	205	0.20	1.6	—	—	—	190	0.20	1.6	—	—	—	—	—	—	40	0.15	1.0
	T9325	0.4	180	0.20	1.6	—	—	—	170	0.20	1.6	—	—	—	—	—	—	—	—	—
	T9335	0.4	155	0.20	1.6	—	—	—	—	—	—	—	—	—	—	—	—	—	—	—
TNMG 160408E-M	T5305	0.8	250	0.30	1.6	—	—	—	235	0.30	1.6	—	—	—	—	—	—	50	0.15	1.0
	T5315	0.8	225	0.30	1.6	—	—	—	210	0.30	1.6	—	—	—	—	—	—	45	0.15	1.0
	T9310	0.8	220	0.30	1.6	—	—	—	205	0.30	1.6	—	—	—	—	—	—	40	0.15	1.0
	T9315	0.8	205	0.30	1.6	—	—	—	190	0.30	1.6	—	—	—	—	—	—	40	0.15	1.0
	T9325	0.8	185	0.30	1.6	—	—	—	175	0.30	1.6	—	—	—	—	—	—	—	—	—
TNMG 160412E-M	T5315	1.2	215	0.40	1.6	—	—	—	200	0.40	1.6	—	—	—	—	—	—	40	0.15	1.0
	T9315	1.2	190	0.40	1.6	—	—	—	180	0.40	1.6	—	—	—	—	—	—	35	0.15	1.0
	T9325	1.2	170	0.40	1.6	—	—	—	160	0.40	1.6	—	—	—	—	—	—	—	—	—
	T9335	1.2	145	0.40	1.6	—	—	—	—	—	—	—	—	—	—	—	—	—	—	—
TNMG 220408E-M	T5305	0.8	245	0.30	2.1	—	—	—	230	0.30	2.1	—	—	—	—	—	—	45	0.15	1.0
	T5315	0.8	215	0.30	2.1	—	—	—	200	0.30	2.1	—	—	—	—	—	—	40	0.15	1.0
	T9310	0.8	215	0.30	2.1	—	—	—	200	0.30	2.1	—	—	—	—	—	—	40	0.15	1.0
	T9315	0.8	200	0.30	2.1	—	—	—	190	0.30	2.1	—	—	—	—	—	—	40	0.15	1.0
	T9325	0.8	180	0.30	2.1	—	—	—	170	0.30	2.1	—	—	—	—	—	—	—	—	—
TNMG 220412E-M	T5315	1.2	205	0.40	2.1	—	—	—	190	0.40	2.1	—	—	—	—	—	—	40	0.15	1.0
	T9315	1.2	185	0.40	2.1	—	—	—	175	0.40	2.1	—	—	—	—	—	—	35	0.15	1.0
	T9325	1.2	165	0.40	2.1	—	—	—	155	0.40	2.1	—	—	—	—	—	—	—	—	—
	T9335	1.2	140	0.40	2.1	—	—	—	—	—	—	—	—	—	—	—	—	—	—	—

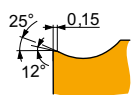

NF geometria con design altamente positivo per operazioni da finitura fino a medie lavorazioni, taglio continuo.

TNMG 160404E-NF	HF7	0.4	—	—	—	90	0.14	1.4	140	0.15	1.4	450	0.18	1.4	—	—	—	—	—	—
	T6310	0.4	150	0.17	1.4	105	0.15	1.4	120	0.17	1.4	450	0.20	1.4	45	0.15	1.1	—	—	—
	T7325	0.4	170	0.18	1.4	130	0.16	1.4	—	—	—	—	—	—	55	0.16	1.1	—	—	—
	T7335	0.4	165	0.18	1.4	125	0.16	1.4	—	—	—	—	—	—	50	0.16	1.1	—	—	—
	T8315	0.4	160	0.17	1.4	95	0.15	1.4	150	0.17	1.4	480	0.20	1.4	40	0.15	1.1	—	—	—
	T8330	0.4	155	0.17	1.4	90	0.15	1.4	145	0.17	1.4	465	0.20	1.4	35	0.15	1.1	—	—	—
	T8430	0.4	175	0.17	1.4	95	0.15	1.4	140	0.17	1.4	480	0.20	1.4	35	0.15	1.1	—	—	—
	T9315	0.4	255	0.15	1.4	—	—	—	240	0.15	1.4	—	—	—	—	—	—	—	—	—
	T9325	0.4	215	0.18	1.4	125	0.16	1.4	200	0.18	1.4	—	—	—	45	0.16	1.1	—	—	—



Idoneità e valori iniziali per velocità di taglio (Vc), avanzamento (f) e profondità di taglio (ap). Fare riferimento alla nostra App Machining Calculator per ulteriori calcoli.

Codice prodotto	RE (mm)	P			M			K			N			S			H		
		vc (m/min)	f (mm/rev)	ap (mm)	vc (m/min)	f (mm/rev)	ap (mm)	vc (m/min)	f (mm/rev)	ap (mm)	vc (m/min)	f (mm/rev)	ap (mm)	vc (m/min)	f (mm/rev)	ap (mm)	vc (m/min)	f (mm/rev)	ap (mm)

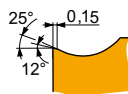

NF geometria con design altamente positivo per operazioni da finitura fino a medie lavorazioni, taglio continuo.

TNMG 160408E-NF	HF7	0.8	—	—	—	100	0.15	1.4	160	0.17	1.4	510	0.20	1.4	—	—	—	—	—	—
	T6310	0.8	180	0.18	1.4	125	0.16	1.4	145	0.18	1.4	540	0.22	1.4	50	0.16	1.1	—	—	—
	T7325	0.8	200	0.18	1.4	155	0.16	1.4	—	—	—	—	—	—	65	0.16	1.1	—	—	—
	T7335	0.8	195	0.18	1.4	150	0.16	1.4	—	—	—	—	—	—	60	0.16	1.1	—	—	—
	T8315	0.8	190	0.18	1.4	110	0.16	1.4	180	0.18	1.4	570	0.22	1.4	45	0.16	1.1	—	—	—
	T8330	0.8	180	0.18	1.4	105	0.16	1.4	170	0.18	1.4	540	0.22	1.4	45	0.16	1.1	—	—	—
	T8430	0.8	205	0.18	1.4	110	0.16	1.4	170	0.18	1.4	570	0.22	1.4	45	0.16	1.1	—	—	—
	T9315	0.8	290	0.17	1.4	—	—	—	275	0.17	1.4	—	—	—	—	—	—	—	—	—
	T9325	0.8	255	0.18	1.4	150	0.16	1.4	240	0.18	1.4	—	—	—	55	0.16	1.1	—	—	—

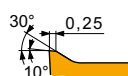

NM geometria con design altamente positivo per operazioni di finitura, media sgrassatura, taglio continuo.

TNMG 160404E-NM	T7325	0.4	170	0.20	1.9	130	0.18	1.9	—	—	—	—	—	—	55	0.20	1.5	—	—	—
	T7335	0.4	160	0.20	1.9	120	0.18	1.9	—	—	—	—	—	—	50	0.20	1.5	—	—	—
	T8315	0.4	160	0.20	1.9	95	0.18	1.9	—	—	—	480	0.24	1.9	40	0.20	1.5	—	—	—
	T8330	0.4	145	0.20	1.9	85	0.18	1.9	—	—	—	435	0.24	1.9	35	0.20	1.5	—	—	—
	T8430	0.4	170	0.20	1.9	90	0.18	1.9	—	—	—	465	0.24	1.9	35	0.20	1.5	—	—	—
	T9325	0.4	210	0.20	1.9	125	0.18	1.9	—	—	—	—	—	—	45	0.20	1.5	—	—	—
TNMG 160408E-NM	T7325	0.8	190	0.25	1.9	145	0.23	1.9	—	—	—	—	—	—	60	0.20	1.5	—	—	—
	T7335	0.8	180	0.25	1.9	140	0.23	1.9	—	—	—	—	—	—	55	0.20	1.5	—	—	—
	T8315	0.8	175	0.25	1.9	105	0.23	1.9	—	—	—	525	0.30	1.9	40	0.20	1.5	—	—	—
	T8330	0.8	165	0.25	1.9	95	0.23	1.9	—	—	—	495	0.30	1.9	40	0.20	1.5	—	—	—
	T8430	0.8	185	0.25	1.9	100	0.23	1.9	—	—	—	510	0.30	1.9	40	0.20	1.5	—	—	—
	T9315	0.8	250	0.25	1.9	—	—	—	—	—	—	—	—	—	—	—	—	—	—	—
TNMG 220408E-NM	T7325	0.8	190	0.25	1.7	145	0.23	1.7	—	—	—	—	—	—	60	0.20	1.4	—	—	—
	T7335	0.8	185	0.25	1.7	140	0.23	1.7	—	—	—	—	—	—	60	0.20	1.4	—	—	—
	T8315	0.8	175	0.25	1.7	105	0.23	1.7	—	—	—	525	0.30	1.7	40	0.20	1.4	—	—	—
	T8330	0.8	165	0.25	1.7	95	0.23	1.7	—	—	—	495	0.30	1.7	40	0.20	1.4	—	—	—
	T8430	0.8	185	0.25	1.7	100	0.23	1.7	—	—	—	510	0.30	1.7	40	0.20	1.4	—	—	—
	T9315	0.8	255	0.25	1.7	—	—	—	—	—	—	—	—	—	—	—	—	—	—	—
TNMG 220412E-NM	T7325	1.2	190	0.30	1.7	145	0.27	1.7	—	—	—	—	—	—	60	0.24	1.4	—	—	—
	T7335	1.2	180	0.30	2.1	140	0.27	2.1	—	—	—	—	—	—	55	0.24	1.7	—	—	—
	T9325	1.2	225	0.25	1.7	135	0.23	1.7	—	—	—	—	—	—	50	0.20	1.4	—	—	—

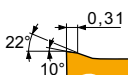

NMR geometria con design positivo per operazioni da media fino a sgrassatura, taglio continuo.

TNMG 160404E-NMR	T6310	0.4	130	0.20	1.7	90	0.18	1.7	—	—	—	—	—	—	35	0.18	1.4	—	—	—	
	T7325	0.4	145	0.20	1.7	110	0.18	1.7	—	—	—	—	—	—	45	0.18	1.4	—	—	—	
	T7335	0.4	145	0.20	1.7	110	0.18	1.7	—	—	—	—	—	—	45	0.18	1.4	—	—	—	
	T8330	0.4	130	0.20	1.7	75	0.18	1.7	—	—	—	—	—	—	30	0.18	1.4	—	—	—	
	T8430	0.4	145	0.20	1.7	80	0.18	1.7	—	—	—	—	—	—	30	0.18	1.4	—	—	—	
	T9315	0.4	200	0.20	1.7	—	—	—	—	—	—	—	—	—	—	—	—	—	—	—	—
	T9325	0.4	180	0.20	1.7	105	0.18	1.7	—	—	—	—	—	—	40	0.18	1.4	—	—	—	
TNMG 160408E-NMR	T6310	0.8	140	0.30	1.7	100	0.27	1.7	—	—	—	—	—	—	40	0.24	1.4	—	—	—	
	T7325	0.8	155	0.30	1.7	120	0.27	1.7	—	—	—	—	—	—	50	0.24	1.4	—	—	—	
	T7335	0.8	145	0.30	1.7	110	0.27	1.7	—	—	—	—	—	—	45	0.24	1.4	—	—	—	
	T8330	0.8	140	0.30	1.7	80	0.27	1.7	—	—	—	—	—	—	35	0.24	1.4	—	—	—	
	T8430	0.8	150	0.30	1.7	80	0.27	1.7	—	—	—	—	—	—	30	0.24	1.4	—	—	—	
	T9315	0.8	205	0.30	1.7	—	—	—	—	—	—	—	—	—	—	—	—	—	—	—	—
T9325	0.8	185	0.30	1.7	110	0.27	1.7	—	—	—	—	—	—	40	0.24	1.4	—	—	—		



Idoneità e valori iniziali per velocità di taglio (Vc), avanzamento (f) e profondità di taglio (ap). Fare riferimento alla nostra App Machining Calculator per ulteriori calcoli.

Codice prodotto	RE  (mm)	P			M			K			N			S			H		
		vc (m/min)	f (mm/rev)	ap (mm)	vc (m/min)	f (mm/rev)	ap (mm)	vc (m/min)	f (mm/rev)	ap (mm)	vc (m/min)	f (mm/rev)	ap (mm)	vc (m/min)	f (mm/rev)	ap (mm)	vc (m/min)	f (mm/rev)	ap (mm)

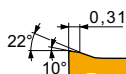

NMR geometria con design positivo per operazioni da media fino a sgrossatura, taglio continuo.

TNMG 160412E-NMR	T7325	1.2	165	0.30	1.7	125	0.27	1.7	–	–	–	–	–	–	–	50	0.24	1.4	–	–	–	
	T9315	1.2	215	0.30	1.7	–	–	–	–	–	–	–	–	–	–	–	–	–	–	–	–	
	T9325	1.2	195	0.30	1.7	115	0.27	1.7	–	–	–	–	–	–	–	40	0.24	1.4	–	–	–	
TNMG 220408E-NMR	T6310	0.8	135	0.30	2.1	95	0.27	2.1	–	–	–	–	–	–	–	40	0.24	1.7	–	–	–	
	T7325	0.8	150	0.30	2.1	115	0.27	2.1	–	–	–	–	–	–	–	45	0.24	1.7	–	–	–	
	T7335	0.8	145	0.30	2.1	110	0.27	2.1	–	–	–	–	–	–	–	45	0.24	1.7	–	–	–	
	T8330	0.8	135	0.30	2.1	80	0.27	2.1	–	–	–	–	–	–	–	30	0.24	1.7	–	–	–	
	T8430	0.8	145	0.30	2.1	80	0.27	2.1	–	–	–	–	–	–	–	30	0.24	1.7	–	–	–	
	T9315	0.8	200	0.30	2.1	–	–	–	–	–	–	–	–	–	–	–	–	–	–	–	–	–
	T9325	0.8	180	0.30	2.1	105	0.27	2.1	–	–	–	–	–	–	–	40	0.24	1.7	–	–	–	
TNMG 220412E-NMR	T6310	1.2	140	0.30	2.1	100	0.27	2.1	–	–	–	–	–	–	–	40	0.24	1.7	–	–	–	
	T7325	1.2	160	0.30	2.1	120	0.27	2.1	–	–	–	–	–	–	–	50	0.24	1.7	–	–	–	
	T9315	1.2	210	0.30	2.1	–	–	–	–	–	–	–	–	–	–	–	–	–	–	–	–	
	T9325	1.2	190	0.30	2.1	110	0.27	2.1	–	–	–	–	–	–	–	40	0.24	1.7	–	–	–	

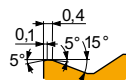

R geometria per operazioni da semi sgrossatura fino a sgrossatura, da taglio continuo a interrotto.

TNMG 160408E-R	T5305	0.8	210	0.40	3.0	–	–	–	195	0.40	3.0	–	–	–	–	–	–	–	40	0.15	1.0
	T5315	0.8	185	0.40	3.0	–	–	–	175	0.40	3.0	–	–	–	–	–	–	–	35	0.15	1.0
	T9310	0.8	185	0.40	3.0	–	–	–	175	0.40	3.0	–	–	–	–	–	–	–	35	0.15	1.0
	T9315	0.8	165	0.40	3.0	–	–	–	155	0.40	3.0	–	–	–	–	–	–	–	30	0.15	1.0
	T9325	0.8	150	0.40	3.0	–	–	–	140	0.40	3.0	–	–	–	–	–	–	–	–	–	–
	T9335	0.8	130	0.40	3.0	–	–	–	–	–	–	–	–	–	–	–	–	–	–	–	–
TNMG 160412E-R	T5315	1.2	195	0.40	3.0	–	–	–	185	0.40	3.0	–	–	–	–	–	–	–	35	0.15	1.0
	T9310	1.2	195	0.40	3.0	–	–	–	185	0.40	3.0	–	–	–	–	–	–	–	35	0.15	1.0
	T9325	1.2	160	0.40	3.0	–	–	–	150	0.40	3.0	–	–	–	–	–	–	–	–	–	–
	T9335	1.2	140	0.40	3.0	–	–	–	–	–	–	–	–	–	–	–	–	–	–	–	–
TNMG 220408E-R	T9315	0.8	165	0.40	4.0	–	–	–	155	0.40	4.0	–	–	–	–	–	–	–	30	0.15	1.0
	T9325	0.8	145	0.40	4.0	–	–	–	135	0.40	4.0	–	–	–	–	–	–	–	–	–	–
	T9335	0.8	125	0.40	4.0	–	–	–	–	–	–	–	–	–	–	–	–	–	–	–	–
TNMG 220412E-R	T9310	1.2	185	0.40	4.0	–	–	–	175	0.40	4.0	–	–	–	–	–	–	–	35	0.15	1.0
	T9315	1.2	170	0.40	4.0	–	–	–	160	0.40	4.0	–	–	–	–	–	–	–	30	0.15	1.0
	T9325	1.2	155	0.40	4.0	–	–	–	145	0.40	4.0	–	–	–	–	–	–	–	–	–	–
TNMG 220416E-R	T9315	1.6	180	0.40	4.0	–	–	–	170	0.40	4.0	–	–	–	–	–	–	–	35	0.15	1.0
	T9325	1.6	165	0.40	4.0	–	–	–	155	0.40	4.0	–	–	–	–	–	–	–	–	–	–

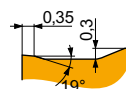

RM geometria per operazioni da semi sgrossatura fino a sgrossatura, da taglio continuo a interrotto.

TNMG 160408E-RM	T5305	0.8	245	0.40	3.0	–	–	–	230	0.40	3.0	–	–	–	–	–	–	–	–	–	–
	T5315	0.8	215	0.40	3.0	–	–	–	200	0.40	3.0	–	–	–	–	–	–	–	–	–	–
	T7325	0.8	155	0.40	3.0	120	0.36	3.0	–	–	–	–	–	–	–	–	–	–	–	–	
	T7335	0.8	145	0.40	3.0	110	0.36	3.0	–	–	–	–	–	–	–	–	–	–	–	–	–
	T9310	0.8	210	0.40	3.0	–	–	–	195	0.40	3.0	–	–	–	–	–	–	–	–	–	–
	T9315	0.8	195	0.40	3.0	–	–	–	185	0.40	3.0	–	–	–	–	–	–	–	–	–	–
	T9325	0.8	175	0.40	3.0	105	0.36	3.0	165	0.40	3.0	–	–	–	–	–	–	–	–	–	–
	T9335	0.8	150	0.40	3.0	90	0.36	3.0	–	–	–	–	–	–	–	–	–	–	–	–	–



Idoneità e valori iniziali per velocità di taglio (Vc), avanzamento (f) e profondità di taglio (ap). Fare riferimento alla nostra App Machining Calculator per ulteriori calcoli.

Codice prodotto	RE  (mm)	P			M			K			N			S			H		
		vc (m/min)	f (mm/rev)	ap (mm)	vc (m/min)	f (mm/rev)	ap (mm)	vc (m/min)	f (mm/rev)	ap (mm)	vc (m/min)	f (mm/rev)	ap (mm)	vc (m/min)	f (mm/rev)	ap (mm)	vc (m/min)	f (mm/rev)	ap (mm)

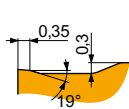

RM geometria per operazioni da semi sgrassatura fino a sgrassatura, da taglio continuo a interrotto.

TNMG 160412E-RM	T5305	1.2	255	0.40	3.0	-	-	-	240	0.40	3.0	-	-	-	-	-	-	-
	T5315	1.2	225	0.40	3.0	-	-	-	210	0.40	3.0	-	-	-	-	-	-	-
	T7325	1.2	165	0.40	3.0	125	0.36	3.0	-	-	-	-	-	-	-	-	-	-
	T7335	1.2	155	0.40	3.0	120	0.36	3.0	-	-	-	-	-	-	-	-	-	-
	T8330	1.2	145	0.40	3.0	85	0.36	3.0	135	0.40	3.0	-	-	-	-	-	-	-
	T8430	1.2	150	0.40	3.0	80	0.36	3.0	125	0.40	3.0	-	-	-	-	-	-	-
	T9315	1.2	205	0.40	3.0	-	-	-	190	0.40	3.0	-	-	-	-	-	-	-
	T9325	1.2	185	0.40	3.0	110	0.36	3.0	175	0.40	3.0	-	-	-	-	-	-	-
	T9335	1.2	160	0.40	3.0	95	0.36	3.0	-	-	-	-	-	-	-	-	-	-
TNMG 220408E-RM	T5305	0.8	235	0.40	4.0	-	-	-	220	0.40	4.0	-	-	-	-	-	-	-
	T5315	0.8	210	0.40	4.0	-	-	-	195	0.40	4.0	-	-	-	-	-	-	-
	T7325	0.8	150	0.40	4.0	115	0.36	4.0	-	-	-	-	-	-	-	-	-	
	T7335	0.8	140	0.40	4.0	105	0.36	4.0	-	-	-	-	-	-	-	-	-	
	T9310	0.8	200	0.40	4.0	-	-	-	190	0.40	4.0	-	-	-	-	-	-	-
	T9315	0.8	190	0.40	4.0	-	-	-	180	0.40	4.0	-	-	-	-	-	-	-
	T9325	0.8	170	0.40	4.0	100	0.36	4.0	160	0.40	4.0	-	-	-	-	-	-	
TNMG 220412E-RM	T5305	1.2	245	0.40	4.0	-	-	-	230	0.40	4.0	-	-	-	-	-	-	-
	T5315	1.2	220	0.40	4.0	-	-	-	205	0.40	4.0	-	-	-	-	-	-	-
	T7325	1.2	160	0.40	4.0	120	0.36	4.0	-	-	-	-	-	-	-	-	-	
	T7335	1.2	150	0.40	4.0	115	0.36	4.0	-	-	-	-	-	-	-	-	-	
	T9315	1.2	200	0.40	4.0	-	-	-	190	0.40	4.0	-	-	-	-	-	-	-
	T9325	1.2	180	0.40	4.0	105	0.36	4.0	170	0.40	4.0	-	-	-	-	-	-	
TNMG 220416E-RM	T7325	1.6	165	0.40	4.0	125	0.36	4.0	-	-	-	-	-	-	-	-	-	
	T9315	1.6	210	0.40	4.0	-	-	-	195	0.40	4.0	-	-	-	-	-	-	
	T9325	1.6	185	0.40	4.0	110	0.36	4.0	175	0.40	4.0	-	-	-	-	-	-	
	T9335	1.6	160	0.40	4.0	95	0.36	4.0	-	-	-	-	-	-	-	-	-	
TNMG 270612E-RM	T7325	1.2	110	0.40	6.0	85	0.36	6.0	-	-	-	-	-	-	-	-	-	
	T9325	1.2	120	0.40	6.0	70	0.36	6.0	110	0.40	6.0	-	-	-	-	-	-	
TNMG 270616E-RM	T7325	1.6	115	0.40	6.0	85	0.36	6.0	-	-	-	-	-	-	-	-	-	
	T9226	1.6	115	0.40	6.0	65	0.36	6.0	105	0.40	6.0	-	-	-	-	-	-	
	T9315	1.6	135	0.40	6.0	-	-	-	125	0.40	6.0	-	-	-	-	-	-	
	T9325	1.6	125	0.40	6.0	75	0.36	6.0	115	0.40	6.0	-	-	-	-	-	-	
	T9335	1.6	100	0.40	6.0	60	0.36	6.0	-	-	-	-	-	-	-	-	-	
TNMG 270624E-RM	T7325	2.4	115	0.50	6.0	85	0.45	6.0	-	-	-	-	-	-	-	-	-	
	T9325	2.4	120	0.50	6.0	70	0.45	6.0	110	0.50	6.0	-	-	-	-	-	-	
	T9335	2.4	95	0.50	6.0	55	0.45	6.0	-	-	-	-	-	-	-	-		
TNMG 270632E-RM	T9335	3.2	90	0.60	6.0	50	0.54	6.0	-	-	-	-	-	-	-	-		
TNMG 330924E-RM	T9226	2.4	100	0.50	10.0	60	0.45	10.0	95	0.50	10.0	-	-	-	-	-	-	
	T9335	2.4	90	0.50	10.0	50	0.45	10.0	-	-	-	-	-	-	-	-		

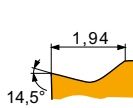

SF geometria con design positivo per operazioni di finitura su pareti sottili, taglio continuo.

TNMG 160404E-SF	H07	0.4	-	-	-	75	0.14	1.3	120	0.15	1.3	390	0.18	1.3	35	0.12	1.0	-
	T6310	0.4	150	0.15	1.3	105	0.14	1.3	120	0.15	1.3	450	0.18	1.3	45	0.12	1.0	30
	T7325	0.4	170	0.17	1.3	130	0.15	1.3	-	-	-	-	-	55	0.15	1.0	-	
	T7335	0.4	165	0.17	1.3	125	0.15	1.3	-	-	-	-	-	50	0.15	1.0	-	
	T8315	0.4	160	0.15	1.3	95	0.14	1.3	150	0.15	1.3	480	0.18	1.3	40	0.12	1.0	30
	T8330	0.4	150	0.15	1.3	90	0.14	1.3	140	0.15	1.3	450	0.18	1.3	35	0.12	1.0	30
	T8430	0.4	180	0.15	1.3	95	0.14	1.3	145	0.15	1.3	495	0.18	1.3	35	0.12	1.0	30
	T9315	0.4	245	0.15	1.3	-	-	-	230	0.15	1.3	-	-	-	-	-	45	0.15
	T9325	0.4	210	0.17	1.3	125	0.15	1.3	195	0.17	1.3	-	-	-	45	0.15	1.0	-



Idoneità e valori iniziali per velocità di taglio (Vc), avanzamento (f) e profondità di taglio (ap). Fare riferimento alla nostra App Machining Calculator per ulteriori calcoli.

Codice prodotto	RE  (mm)	P			M			K			N			S			H		
		vc (m/min)	f (mm/rev)	ap (mm)	vc (m/min)	f (mm/rev)	ap (mm)	vc (m/min)	f (mm/rev)	ap (mm)	vc (m/min)	f (mm/rev)	ap (mm)	vc (m/min)	f (mm/rev)	ap (mm)	vc (m/min)	f (mm/rev)	ap (mm)

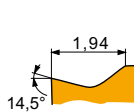

SF geometria con design positivo per operazioni di finitura su pareti sottili, taglio continuo.

TNMG 160408E-SF	H07	0.8	–	–	–	85	0.15	1.3	140	0.17	1.3	445	0.20	1.3	45	0.14	1.0	–	–	–
	T6310	0.8	175	0.17	1.3	125	0.15	1.3	140	0.17	1.3	525	0.20	1.3	50	0.14	1.0	35	0.15	1.0
	T7325	0.8	200	0.17	1.3	155	0.15	1.3	–	–	–	–	–	–	65	0.15	1.0	–	–	–
	T7335	0.8	195	0.17	1.3	150	0.15	1.3	–	–	–	–	–	–	60	0.15	1.0	–	–	–
	T8315	0.8	185	0.17	1.3	110	0.15	1.3	175	0.17	1.3	555	0.20	1.3	45	0.14	1.0	35	0.15	1.0
	T8330	0.8	175	0.17	1.3	105	0.15	1.3	165	0.17	1.3	525	0.20	1.3	40	0.14	1.0	35	0.15	1.0
	T8430	0.8	205	0.17	1.3	110	0.15	1.3	170	0.17	1.3	570	0.20	1.3	45	0.14	1.0	35	0.15	1.0
	T9315	0.8	275	0.17	1.3	–	–	–	260	0.17	1.3	–	–	–	–	–	–	55	0.15	1.0
	T9325	0.8	250	0.17	1.3	150	0.15	1.3	235	0.17	1.3	–	–	–	55	0.15	1.0	–	–	–
TNMG 160412E-SF	T6310	1.2	160	0.30	1.3	115	0.27	1.3	125	0.30	1.3	480	0.36	1.3	45	0.21	1.0	30	0.15	1.0
	T7325	1.2	175	0.30	1.3	135	0.27	1.3	–	–	–	–	–	55	0.21	1.0	–	–	–	
	T9325	1.2	205	0.30	1.3	120	0.27	1.3	190	0.30	1.3	–	–	–	45	0.21	1.0	–	–	–
TNMG 220404E-SF	T6310	0.4	145	0.17	1.7	100	0.15	1.7	115	0.17	1.7	435	0.20	1.7	40	0.15	1.4	25	0.15	1.0
	T7325	0.4	160	0.17	1.7	120	0.15	1.7	–	–	–	–	–	50	0.15	1.4	–	–	–	
	T9325	0.4	205	0.17	1.7	120	0.15	1.7	190	0.17	1.7	–	–	–	45	0.15	1.4	–	–	–
TNMG 220408E-SF	T6310	0.8	170	0.17	1.7	120	0.15	1.7	135	0.17	1.7	510	0.20	1.7	50	0.15	1.4	30	0.15	1.0
	T8315	0.8	180	0.17	1.7	105	0.15	1.7	170	0.17	1.7	540	0.20	1.7	45	0.15	1.4	35	0.15	1.0
	T8430	0.8	195	0.17	1.7	105	0.15	1.7	160	0.17	1.7	540	0.20	1.7	40	0.15	1.4	30	0.15	1.0
TNMG 220412E-SF	T6310	1.2	155	0.30	1.7	110	0.27	1.7	125	0.30	1.7	465	0.36	1.7	45	0.21	1.4	30	0.15	1.0
	T7325	1.2	170	0.30	1.7	130	0.27	1.7	–	–	–	–	–	55	0.21	1.4	–	–	–	
	T9325	1.2	205	0.30	1.7	120	0.27	1.7	190	0.30	1.7	–	–	–	45	0.21	1.4	–	–	–

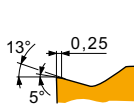

SM geometria con design positivo per medie lavorazioni, da taglio continuo a interrotto.

TNMG 160404E-SM	T6310	0.4	135	0.22	1.7	95	0.20	1.7	105	0.22	1.7	405	0.26	1.7	40	0.20	1.4	25	0.15	1.0	
	T7325	0.4	150	0.22	1.7	115	0.20	1.7	–	–	–	–	–	45	0.20	1.4	–	–	–		
	T7335	0.4	145	0.22	1.7	110	0.20	1.7	–	–	–	–	–	45	0.20	1.4	–	–	–		
	T8330	0.4	135	0.22	1.7	80	0.20	1.7	125	0.22	1.7	405	0.26	1.7	30	0.20	1.4	25	0.15	1.0	
	T8430	0.4	145	0.22	1.7	80	0.20	1.7	120	0.22	1.7	405	0.26	1.7	30	0.20	1.4	25	0.15	1.0	
	T9315	0.4	210	0.20	1.7	–	–	–	195	0.20	1.7	–	–	–	–	–	–	40	0.15	1.0	
	T9325	0.4	185	0.22	1.7	110	0.20	1.7	175	0.22	1.7	–	–	–	40	0.20	1.4	–	–	–	
	TNMG 160408E-SM	T6310	0.8	150	0.25	1.7	105	0.23	1.7	120	0.25	1.7	450	0.30	1.7	45	0.20	1.4	30	0.15	1.0
		T7325	0.8	170	0.25	1.7	130	0.23	1.7	–	–	–	–	–	55	0.20	1.4	–	–	–	
T7335		0.8	165	0.25	1.7	125	0.23	1.7	–	–	–	–	–	50	0.20	1.4	–	–	–		
T8330		0.8	150	0.25	1.7	90	0.23	1.7	140	0.25	1.7	450	0.30	1.7	35	0.20	1.4	30	0.15	1.0	
T8430		0.8	170	0.25	1.7	90	0.23	1.7	135	0.25	1.7	465	0.30	1.7	35	0.20	1.4	25	0.15	1.0	
T9315		0.8	230	0.25	1.7	–	–	–	215	0.25	1.7	–	–	–	–	–	–	45	0.15	1.0	
T9325		0.8	205	0.25	1.7	120	0.23	1.7	190	0.25	1.7	–	–	–	45	0.20	1.4	–	–	–	
TNMG 160412E-SM		T6310	1.2	155	0.30	1.7	110	0.27	1.7	125	0.30	1.7	465	0.36	1.7	45	0.24	1.4	30	0.15	1.0
		T7325	1.2	170	0.30	1.7	130	0.27	1.7	–	–	–	–	–	55	0.24	1.4	–	–	–	
	T7335	1.2	165	0.30	1.7	125	0.27	1.7	–	–	–	–	–	50	0.24	1.4	–	–	–		
	T9325	1.2	205	0.30	1.7	120	0.27	1.7	190	0.30	1.7	–	–	–	45	0.24	1.4	–	–	–	
TNMG 220404E-SM	T6310	0.4	130	0.24	1.7	90	0.22	1.7	100	0.24	1.7	390	0.29	1.7	35	0.22	1.4	25	0.15	1.0	
	T7325	0.4	145	0.24	1.7	110	0.22	1.7	–	–	–	–	–	45	0.22	1.4	–	–	–		
	T8330	0.4	130	0.24	1.7	75	0.22	1.7	120	0.24	1.7	390	0.29	1.7	30	0.22	1.4	25	0.15	1.0	
	T8430	0.4	145	0.24	1.7	80	0.22	1.7	120	0.24	1.7	405	0.29	1.7	30	0.22	1.4	25	0.15	1.0	
	T9325	0.4	175	0.24	1.7	105	0.22	1.7	165	0.24	1.7	–	–	–	35	0.22	1.4	–	–	–	
TNMG 220408E-SM	T6310	0.8	150	0.25	1.7	105	0.23	1.7	120	0.25	1.7	450	0.30	1.7	45	0.20	1.4	30	0.15	1.0	
	T7325	0.8	170	0.25	1.7	130	0.23	1.7	–	–	–	–	–	55	0.20	1.4	–	–	–		
	T7335	0.8	165	0.25	1.7	125	0.23	1.7	–	–	–	–	–	50	0.20	1.4	–	–	–		
	T8330	0.8	150	0.25	1.7	90	0.23	1.7	140	0.25	1.7	450	0.30	1.7	35	0.20	1.4	30	0.15	1.0	
	T8430	0.8	170	0.25	1.7	90	0.23	1.7	135	0.25	1.7	465	0.30	1.7	35	0.20	1.4	25	0.15	1.0	
	T9315	0.8	230	0.25	1.7	–	–	–	215	0.25	1.7	–	–	–	–	–	–	45	0.15	1.0	
	T9325	0.8	205	0.25	1.7	120	0.23	1.7	190	0.25	1.7	–	–	–	45	0.20	1.4	–	–	–	



Idoneità e valori iniziali per velocità di taglio (Vc), avanzamento (f) e profondità di taglio (ap). Fare riferimento alla nostra App Machining Calculator per ulteriori calcoli.

Codice prodotto	RE (mm)	P			M			K			N			S			H		
		vc (m/min)	f (mm/rev)	ap (mm)	vc (m/min)	f (mm/rev)	ap (mm)	vc (m/min)	f (mm/rev)	ap (mm)	vc (m/min)	f (mm/rev)	ap (mm)	vc (m/min)	f (mm/rev)	ap (mm)	vc (m/min)	f (mm/rev)	ap (mm)

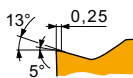

SM geometria con design positivo per medie lavorazioni, da taglio continuo a interrotto.

TNMG 220412E-SM	T6310	1.2	155	0.30	1.7	110	0.27	1.7	125	0.30	1.7	465	0.36	1.7	45	0.24	1.4	30	0.15	1.0
	T7325	1.2	170	0.30	1.7	130	0.27	1.7	-	-	-	-	-	-	55	0.24	1.4	-	-	-
	T7335	1.2	165	0.30	1.7	125	0.27	1.7	-	-	-	-	-	-	50	0.24	1.4	-	-	-
	T9315	1.2	225	0.30	1.7	-	-	-	210	0.30	1.7	-	-	-	-	-	-	45	0.15	1.0
	T9325	1.2	205	0.30	1.7	120	0.27	1.7	190	0.30	1.7	-	-	-	45	0.24	1.4	-	-	-

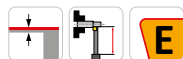
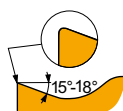

ER-SI geometria positiva destra per operazioni da finitura fino a semi sgrossatura, taglio continuo.

TNMG 160404ER-SI	T7325	0.4	190	0.20	1.5	145	0.18	1.5	-	-	-	-	-	-	60	0.18	1.2	-	-	-
	T7335	0.4	180	0.20	1.5	140	0.18	1.5	-	-	-	-	-	-	55	0.18	1.2	-	-	-
	T8315	0.4	175	0.20	1.5	105	0.18	1.5	-	-	-	525	0.24	1.5	40	0.18	1.2	-	-	-
	T8330	0.4	165	0.20	1.5	95	0.18	1.5	-	-	-	495	0.24	1.5	40	0.18	1.2	-	-	-
	T8430	0.4	185	0.20	1.5	100	0.18	1.5	-	-	-	510	0.24	1.5	40	0.18	1.2	-	-	-
	T9325	0.4	230	0.20	1.5	135	0.18	1.5	-	-	-	-	-	-	50	0.18	1.2	-	-	-
	T9335	0.4	195	0.20	1.5	115	0.18	1.5	-	-	-	-	-	-	40	0.18	1.2	-	-	-
	TNMG 160408ER-SI	T7325	0.8	190	0.35	1.5	145	0.32	1.5	-	-	-	-	-	-	60	0.25	1.2	-	-
T7335		0.8	180	0.35	1.5	140	0.32	1.5	-	-	-	-	-	-	55	0.25	1.2	-	-	-
T8315		0.8	175	0.35	1.5	105	0.32	1.5	-	-	-	525	0.42	1.5	40	0.25	1.2	-	-	-
T8330		0.8	170	0.35	1.5	100	0.32	1.5	-	-	-	510	0.42	1.5	40	0.25	1.2	-	-	-
T8430		0.8	180	0.35	1.5	95	0.32	1.5	-	-	-	495	0.42	1.5	35	0.25	1.2	-	-	-
T9325		0.8	215	0.35	1.5	125	0.32	1.5	-	-	-	-	-	-	45	0.25	1.2	-	-	-
T9335		0.8	190	0.35	1.5	110	0.32	1.5	-	-	-	-	-	-	40	0.25	1.2	-	-	-

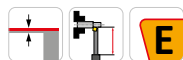
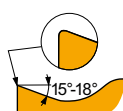

EL-SI geometria positiva sinistra per operazioni da finitura fino a semi sgrossatura, taglio continuo.

TNMG 160404EL-SI	T7325	0.4	190	0.20	1.5	145	0.18	1.5	-	-	-	-	-	-	60	0.18	1.2	-	-	-
	T7335	0.4	180	0.20	1.5	140	0.18	1.5	-	-	-	-	-	-	55	0.18	1.2	-	-	-
	T8315	0.4	175	0.20	1.5	105	0.18	1.5	-	-	-	525	0.24	1.5	40	0.18	1.2	-	-	-
	T8330	0.4	165	0.20	1.5	95	0.18	1.5	-	-	-	495	0.24	1.5	40	0.18	1.2	-	-	-
	T8430	0.4	185	0.20	1.5	100	0.18	1.5	-	-	-	510	0.24	1.5	40	0.18	1.2	-	-	-
	T9325	0.4	230	0.20	1.5	135	0.18	1.5	-	-	-	-	-	-	50	0.18	1.2	-	-	-
	T9335	0.4	195	0.20	1.5	115	0.18	1.5	-	-	-	-	-	-	40	0.18	1.2	-	-	-
	TNMG 160408EL-SI	T7325	0.8	190	0.35	1.5	145	0.32	1.5	-	-	-	-	-	-	60	0.25	1.2	-	-
T7335		0.8	180	0.35	1.5	140	0.32	1.5	-	-	-	-	-	-	55	0.25	1.2	-	-	-
T8315		0.8	175	0.35	1.5	105	0.32	1.5	-	-	-	525	0.42	1.5	40	0.25	1.2	-	-	-
T8330		0.8	170	0.35	1.5	100	0.32	1.5	-	-	-	510	0.42	1.5	40	0.25	1.2	-	-	-
T8430		0.8	180	0.35	1.5	95	0.32	1.5	-	-	-	495	0.42	1.5	35	0.25	1.2	-	-	-
T9325		0.8	215	0.35	1.5	125	0.32	1.5	-	-	-	-	-	-	45	0.25	1.2	-	-	-
T9335		0.8	190	0.35	1.5	110	0.32	1.5	-	-	-	-	-	-	40	0.25	1.2	-	-	-



TNMM

	IC	D1	L	S
	(mm)	(mm)	(mm)	(mm)
1604	9.525	3.81	16.50	4.76
2204	12.700	5.16	22.00	4.76
2706	15.875	6.35	27.50	6.35

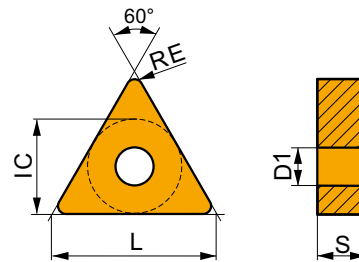

Idoneità e valori iniziali per velocità di taglio (Vc), avanzamento (f) e profondità di taglio (ap). Fare riferimento alla nostra App Machining Calculator per ulteriori calcoli.

Codice prodotto	RE	P			M			K			N			S			H		
		vc	f	ap	vc	f	ap	vc	f	ap	vc	f	ap	vc	f	ap	vc	f	ap
		(m/min)	(mm/rev)	(mm)	(m/min)	(mm/rev)	(mm)	(m/min)	(mm/rev)	(mm)	(m/min)	(mm/rev)	(mm)	(m/min)	(mm/rev)	(mm)	(m/min)	(mm/rev)	(mm)

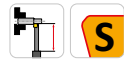
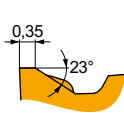

DR geometria per operazioni da semi sgrassatura fino a sgrassatura, da taglio continuo a interrotto.

TNMM 160408E-DR	T9325	0.8	█	175	0.40	4.0	█	105	0.36	4.0	█	165	0.40	4.0	–	–	–	–	–	–
TNMM 220408E-DR	T9325	0.8	█	175	0.40	4.0	█	105	0.36	4.0	█	165	0.40	4.0	–	–	–	–	–	–
	T9335	0.8	█	155	0.40	4.0	█	90	0.36	4.0	–	–	–	–	–	–	–	–	–	
TNMM 220412E-DR	T9315	1.2	█	205	0.40	4.0	–	–	–	█	190	0.40	4.0	–	–	–	–	–	–	
	T9325	1.2	█	185	0.40	4.0	█	110	0.36	4.0	█	175	0.40	4.0	–	–	–	–	–	
	T9335	1.2	█	160	0.40	4.0	█	95	0.36	4.0	–	–	–	–	–	–	–	–		
TNMM 220416E-DR	T9325	1.6	█	195	0.40	4.0	█	115	0.36	4.0	█	185	0.40	4.0	–	–	–	–	–	
TNMM 270616E-DR	T9325	1.6	█	135	0.40	4.0	█	80	0.36	4.0	█	125	0.40	4.0	–	–	–	–	–	
	T9335	1.6	█	110	0.40	4.0	█	65	0.36	4.0	–	–	–	–	–	–	–	–		

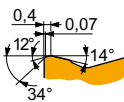

HR geometria per operazioni da sgrassatura fino a sgrassatura pesante, taglio continuo e interrotto.

TNMM 270616E-HR	T9325	1.6	█	90	0.60	7.0	█	50	0.54	7.0	█	85	0.60	7.0	–	–	–	–	–
	T9335	1.6	█	75	0.60	7.0	█	45	0.54	7.0	–	–	–	–	–	–	–	–	
TNMM 270624E-HR	T9226	2.4	█	80	0.65	7.0	█	45	0.59	7.0	█	75	0.65	7.0	–	–	–	–	–

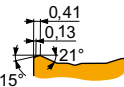

NR2 geometria per operazioni da semi sgrassatura fino a sgrassatura, da taglio continuo a interrotto.

TNMM 160408E-NR2	T9325	0.8	█	165	0.40	3.0	█	95	0.36	3.0	█	155	0.40	3.0	–	–	–	█	35	0.28	2.4
TNMM 220408E-NR2	T7325	0.8	█	145	0.40	4.0	█	110	0.36	4.0	–	–	–	–	–	–	–	█	45	0.28	3.2
	T9325	0.8	█	160	0.40	4.0	█	95	0.36	4.0	█	150	0.40	4.0	–	–	–	█	35	0.28	3.2
TNMM 220412E-NR2	T7325	1.2	█	150	0.40	4.0	█	115	0.36	4.0	–	–	–	–	–	–	–	█	45	0.32	3.2
	T8330	1.2	█	135	0.40	4.0	█	80	0.36	4.0	█	125	0.40	4.0	–	–	–	█	30	0.32	3.2
	T8430	1.2	█	140	0.40	4.0	█	75	0.36	4.0	█	115	0.40	4.0	–	–	–	█	30	0.32	3.2
	T9325	1.2	█	170	0.40	4.0	█	100	0.36	4.0	█	160	0.40	4.0	–	–	–	█	35	0.32	3.2

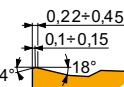

OR geometria per operazioni da semi sgrassatura fino a sgrassatura, da taglio continuo a interrotto.

TNMM 160408E-OR	T9315	0.8	█	185	0.40	3.0	–	–	–	█	175	0.40	3.0	–	–	–	–	–	–	–	
	T9325	0.8	█	165	0.40	3.0	█	95	0.36	3.0	█	155	0.40	3.0	–	–	–	█	35	0.28	2.4
TNMM 160412E-OR	T9325	1.2	█	175	0.40	3.0	█	105	0.36	3.0	█	165	0.40	3.0	–	–	–	█	35	0.32	2.4
TNMM 220408E-OR	T9315	0.8	█	180	0.40	4.0	–	–	–	█	170	0.40	4.0	–	–	–	–	–	–	–	
	T9325	0.8	█	160	0.40	4.0	█	95	0.36	4.0	█	150	0.40	4.0	–	–	–	█	35	0.32	3.2
	T9335	0.8	█	140	0.40	4.0	█	80	0.36	4.0	–	–	–	–	–	–	–	█	30	0.32	3.2
TNMM 220412E-OR	T9325	1.2	█	175	0.40	3.0	█	105	0.36	3.0	█	165	0.40	3.0	–	–	–	█	35	0.32	2.4
	T9335	1.2	█	150	0.40	3.0	█	90	0.36	3.0	–	–	–	–	–	–	–	█	30	0.32	2.4



Idoneità e valori iniziali per velocità di taglio (V_c), avanzamento (f) e profondità di taglio (a_p). Fare riferimento alla nostra App Machining Calculator per ulteriori calcoli.

Codice prodotto	RE (mm)	P			M			K			N			S			H		
		v_c (m/min)	f (mm/rev)	a_p (mm)	v_c (m/min)	f (mm/rev)	a_p (mm)	v_c (m/min)	f (mm/rev)	a_p (mm)	v_c (m/min)	f (mm/rev)	a_p (mm)	v_c (m/min)	f (mm/rev)	a_p (mm)	v_c (m/min)	f (mm/rev)	a_p (mm)

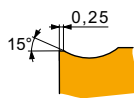

ER geometria destra per operazioni medie fino a semi sgrossatura, taglio continuo.

TNMM 220412ER	T9335	1.2	190	0.35	2.1	110	0.32	2.1	-	-	-	-	-	-	40	0.25	1.7	-	-	-
---------------	-------	-----	-----	------	-----	-----	------	-----	---	---	---	---	---	---	----	------	-----	---	---	---

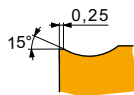

EL geometria sinistra per operazioni medie fino a semi sgrossatura, taglio continuo.

TNMM 220412EL	T9335	1.2	190	0.35	2.1	110	0.32	2.1	-	-	-	-	-	40	0.25	1.7	-	-	-
---------------	-------	-----	-----	------	-----	-----	------	-----	---	---	---	---	---	----	------	-----	---	---	---

TNGA CER



	IC (mm)	D1 (mm)	L (mm)	S (mm)
1604	9.525	3.81	16.50	4.76

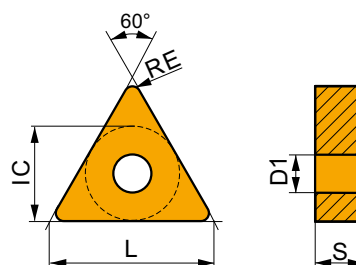

Idoneità e valori iniziali per velocità di taglio (V_c), avanzamento (f) e profondità di taglio (a_p). Fare riferimento alla nostra App Machining Calculator per ulteriori calcoli.

Codice prodotto	RE (mm)	P			M			K			N			S			H		
		v_c (m/min)	f (mm/rev)	a_p (mm)	v_c (m/min)	f (mm/rev)	a_p (mm)	v_c (m/min)	f (mm/rev)	a_p (mm)	v_c (m/min)	f (mm/rev)	a_p (mm)	v_c (m/min)	f (mm/rev)	a_p (mm)	v_c (m/min)	f (mm/rev)	a_p (mm)

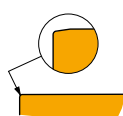

Adatta per lavorazioni con elevata velocità e taglio continuo.

TNGA 160408 T01020	TC100	0.8	-	-	-	-	-	-	475	0.20	1.5	-	-	-	-	-	-	-	-	-
TNGA 160412 T01020	TC100	1.2	-	-	-	-	-	-	500	0.20	1.5	-	-	-	-	-	-	-	-	-



TNGN CER

	IC	L	S
	(mm)	(mm)	(mm)
1604	9.525	16.50	4.76
1607	9.525	16.50	7.94

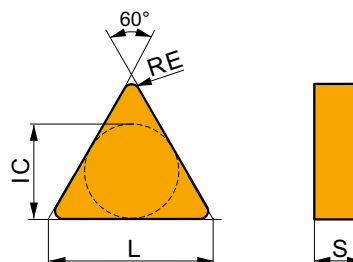

Idoneità e valori iniziali per velocità di taglio (Vc), avanzamento (f) e profondità di taglio (ap). Fare riferimento alla nostra App Machining Calculator per ulteriori calcoli.

Codice prodotto	RE	P			M			K			N			S			H		
		vc	f	ap	vc	f	ap	vc	f	ap	vc	f	ap	vc	f	ap	vc	f	ap
	(mm)	(m/min)	(mm/rev)	(mm)	(m/min)	(mm/rev)	(mm)	(m/min)	(mm/rev)	(mm)	(m/min)	(mm/rev)	(mm)	(m/min)	(mm/rev)	(mm)	(m/min)	(mm/rev)	(mm)

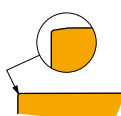

Adatta per lavorazioni con elevata velocità e taglio continuo.

TNGN 160408 T01020	TC100	0.8	-	-	-	-	-	-	475	0.20	1.5	-	-	-	-	-	-	-	-
TNGN 160412 T01020	TC100	1.2	-	-	-	-	-	-	500	0.20	1.5	-	-	-	-	-	-	-	-
TNGN 160708 T02020	TC100	0.8	-	-	-	-	-	-	475	0.20	1.5	-	-	-	-	-	-	-	-

TNGA CBN

	IC	D1	L	S
	(mm)	(mm)	(mm)	(mm)
1604	9.525	3.81	16.50	4.76

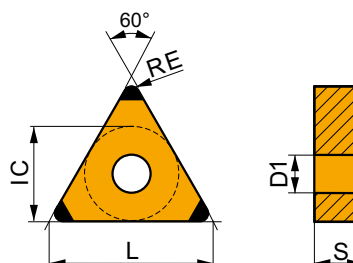

Idoneità e valori iniziali per velocità di taglio (Vc), avanzamento (f) e profondità di taglio (ap). Fare riferimento alla nostra App Machining Calculator per ulteriori calcoli.

Codice prodotto	RE	P			M			K			N			S			H		
		vc	f	ap	vc	f	ap	vc	f	ap	vc	f	ap	vc	f	ap	vc	f	ap
	(mm)	(m/min)	(mm/rev)	(mm)	(m/min)	(mm/rev)	(mm)	(m/min)	(mm/rev)	(mm)	(m/min)	(mm/rev)	(mm)	(m/min)	(mm/rev)	(mm)	(m/min)	(mm/rev)	(mm)

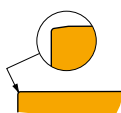

Adatta per operazioni di finitura e taglio continuo.

TNGA 160408S01020C	TB310	0.8	-	-	-	-	-	-	450	0.15	0.6	-	-	-	115	0.11	0.5	95	0.15	1.0
--------------------	-------	-----	---	---	---	---	---	---	-----	------	-----	---	---	---	-----	------	-----	----	------	-----



DTFN(RL) EXT



Utensile esterno, doppio bloccaggio, angolo del tagliente utensile 91° (sfacciare), inserti TN..

Utensile esterno di tornitura, destro / sinistro, doppio bloccaggio a staffa con angolo del tagliente utensile 91°. Adatto per tornitura a sfacciare con spallamento e smussatura con inserti TN.. negativi 16 o 22. Disponibile con stelo 20x20 e 25x25 mm. Corpo trattato per una maggiore durata dell'utensile.

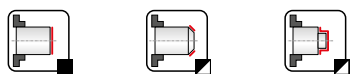
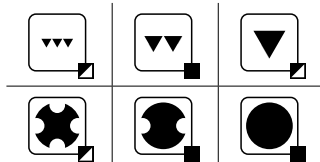
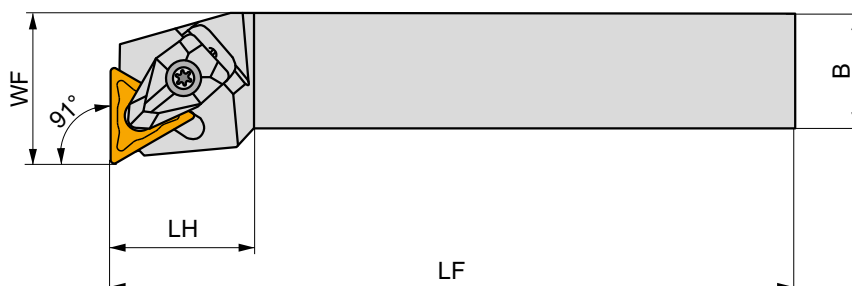
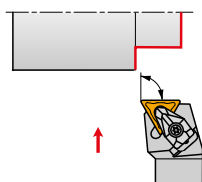

Codice prodotto	H	B	HF	WF	LF	LH	LAMS	GAMO	kg		
	(mm)	(mm)	(mm)	(mm)	(mm)	(mm)	(°)	(°)			
R	DTFNR 2020 K 16	20	20	20	25	125	23.6	-6	0.43	GI024	DT16
	DTFNR 2525 M 16	25	25	25	32	150	23.6	-6	0.77	GI024	DT16
	DTFNR 2525 M 22	25	25	25	32	150	30.5	-6	0.79	GI025	DT22
L	DTFNL 2020 K 16	20	20	20	25	125	23.6	-6	0.43	GI024	DT16
	DTFNL 2525 M 16	25	25	25	32	150	23.6	-6	0.76	GI024	DT16
	DTFNL 2525 M 22	25	25	25	32	150	30.5	-6	0.79	GI025	DT22



GI024
GI025



TN.. 1604..
TN.. 2204..



DT16
DT22

DCS 09
DCS 12

1.7
3.9

DTS 315-02
DTS 315-04

US 2004-T09P
US 2002-T15P

FLAG T09P
FLAG T15P/3,5



DTGN(RL) EXT



Utensile esterno, doppio bloccaggio, angolo del tagliente utensile 91°, inserti TN..

Utensile esterno di tornitura, destro / sinistro, doppio bloccaggio a staffa, con angolo del tagliente utensile di 91°. Adatto per tornitura longitudinale con spallamento, tornitura conica e smussatura con inserti TN.. negativi 16 o 22. Disponibile con stelo da 20x20 a 32x32 mm. Corpo trattato per una maggiore durata dell'utensile.

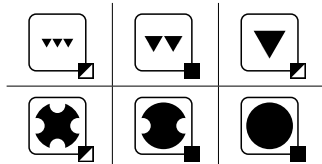
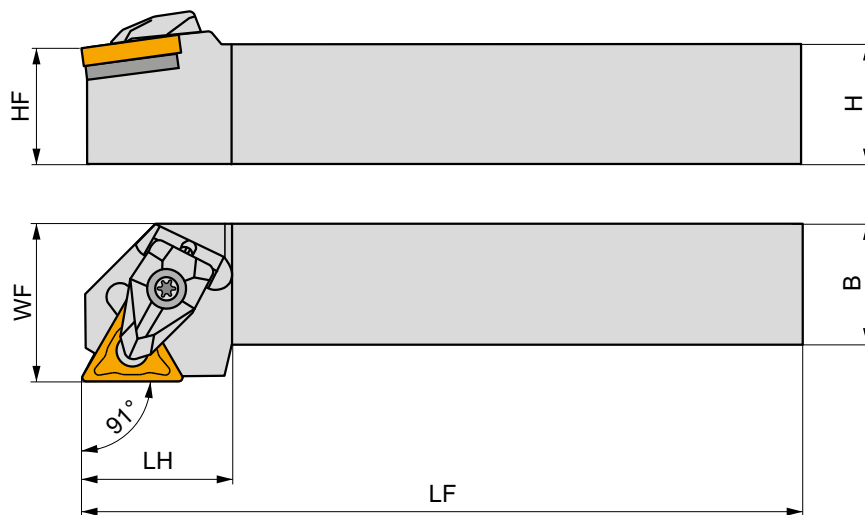
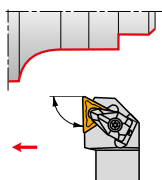

Codice prodotto	H	B	HF	WF	LF	LH	LAMS	GAMO	kg		
	(mm)	(mm)	(mm)	(mm)	(mm)	(mm)	(°)	(°)			
R DTG NR 2020 K 16	20	20	20	25	125	25.4	-6	-6	0.43	GI024	DT16
DTG NR 2525 M 16	25	25	25	32	150	24.6	-6	-6	0.76	GI024	DT16
DTG NR 2525 M 22	25	25	25	32	150	32.1	-6	-6	0.83	GI025	DT22
DTG NR 3232 P 22	32	32	32	40	170	33.1	-6	-6	1.42	GI025	DT22
L DTG NL 2020 K 16	20	20	20	25	125	25.4	-6	-6	0.44	GI024	DT16
DTG NL 2525 M 16	25	25	25	32	150	24.6	-6	-6	0.78	GI024	DT16
DTG NL 2525 M 22	25	25	25	32	150	32.1	-6	-6	0.78	GI025	DT22
DTG NL 3232 P 22	32	32	32	40	170	33.1	-6	-6	1.42	GI025	DT22



GI024

TN.. 1604..

GI025

TN.. 2204..



DT16

DCS 09

1.7

DTS 315-02

US 2004-T09P

FLAG T09P

DT22

DCS 12

3.9

DTS 315-04

US 2002-T15P

FLAG T15P/3,5



MTJN(RL) EXT



Utensile esterno, bloccaggio perno e staffa, angolo del tagliente utensile 93°, inserti TN..

Utensile di tornitura esterno destro / sinistro, bloccaggio perno e staffa con angolo del tagliente utensile di 93°. Adatto per tornitura longitudinale con spallamento, tornitura conica, copiatura fino a 22° e smussatura con inserti TN.. 16 o 22. Disponibile con steli da 20x20 a 32x32 mm. Corpo trattato per una maggiore durata dell'utensile.

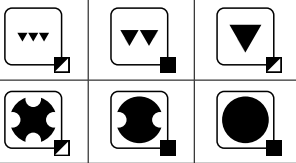
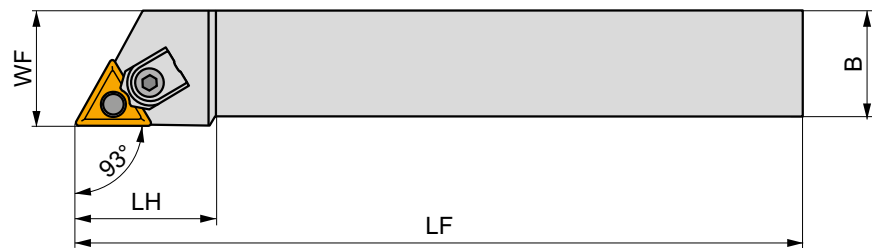
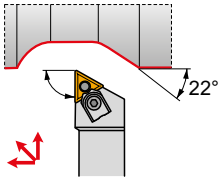

Codice prodotto		H	B	HF	WF	LF	LH	LAMS	GAMO	kg		
		(mm)	(mm)	(mm)	(mm)	(mm)	(mm)	(°)	(°)			
R	MTJNR 2020 K 16	20	20	20	25	125	34	-6	-6	0.42	G1024	MT16
	MTJNR 2525 M 16	25	25	25	32	150	34	-6	-6	0.73	G1024	MT16
	MTJNR 3232 P 22	32	32	32	40	175	42	-6	-6	1.37	G1025	MT22
L	MTJNL 2020 K 16	20	20	20	25	125	34	-6	-6	0.43	G1024	MT16
	MTJNL 2525 M 16	25	25	25	32	150	34	-6	-6	0.75	G1024	MT16
	MTJNL 3232 P 22	32	32	32	40	175	42	-6	-6	1.38	G1025	MT22



G1024
G1025



TN.. 1604..
TN.. 2204..



MT16
MT22



UE 16
UE 22



3.0
5.0



MTN 160312
MTN 220612



UC 52
UC 53



HS 93
HS 94



HXK 5
HXK 5



PTFN(RL) EXT



PRAMET

P



Utensile esterno, bloccaggio a leva, angolo del tagliente utensile 90° (sfacciare), inserti TN..

Utensile di tornitura esterno destro / sinistro, bloccaggio a leva con angolo del tagliente utensile di 90°. Adatto per sfacciatura con spallamento e smussatura, con inserti TN.. negativi 16, 22 o 27. Disponibile con steli da 16x16 fino a 40x40 mm. Corpo trattato per una maggiore durata dell'utensile.

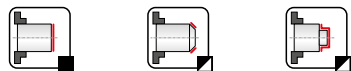
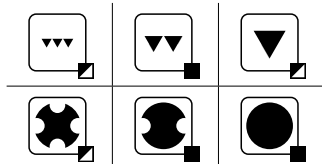
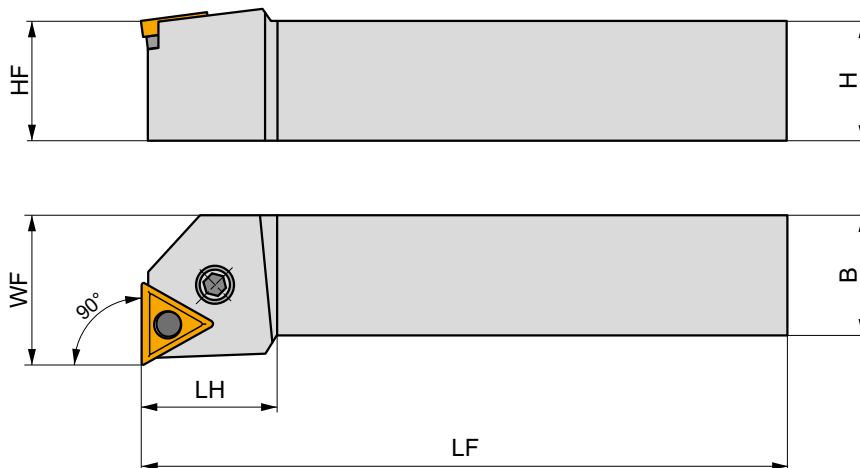
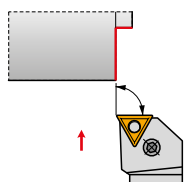

Codice prodotto	H	B	HF	WF	LF	LH	LAMS	GAMO	kg		
	(mm)	(mm)	(mm)	(mm)	(mm)	(mm)	(°)	(°)			
R PTFNR 1616 H 16	16	16	16	20	100	32	-6	-6	0.23	GI024	PT11
PTFNR 2020 K 16	20	20	20	25	125	32	-6	-6	0.44	GI024	PT10
PTFNR 2525 M 16	25	25	25	32	150	32	-6	-6	0.76	GI024	PT10
PTFNR 2525 M 22	25	25	25	32	150	36	-6	-6	0.79	GI025	PT20
PTFNR 3225 P 22	32	25	32	32	170	36	-6	-6	1.05	GI025	PT20
PTFNR 4040 R 27	40	40	40	50	200	40	-6	-6	2.55	GI077	PT40
L PTFNL 1616 H 16	16	16	16	20	100	32	-6	-6	0.24	GI024	PT11
PTFNL 2020 K 16	20	20	20	25	125	32	-6	-6	0.43	GI024	PT10
PTFNL 2525 M 16	25	25	25	32	150	32	-6	-6	0.65	GI024	PT10
PTFNL 2525 M 22	25	25	25	32	150	36	-6	-6	0.79	GI025	PT20
PTFNL 3225 P 22	32	25	32	32	170	36	-6	-6	1.14	GI025	PT20
PTFNL 4040 R 27	40	40	40	50	200	40	-6	-6	2.55	GI077	PT40



GI024

TN.. 1604..

GI025

TN.. 2204..

GI077

TN.. 2706..



PT10

TNU 160308

PU 01

US 34

5.0

M 6x0.75

19

NT 04

MT 04

HXK 3

PT11

TNU 160308

PU 01

US 46

5.0

M 6x0.75

13.2

NT 04

MT 04

HXK 3

PT20

TNU 220312

PU 02

US 35

6.0

M 8x1

22.5

NT 05

MT 05

HXK 4

PT40

TNU 270416

PU 04

US 36

6.0

M 8x1

26

NT 07

MT 07

HXK 4



PTGN(RL) EXT



PRAMET

P



Utensile esterno, bloccaggio a leva, angolo del tagliente utensile 90°, inserti TN..

Utensile di tornitura esterno destro / sinistro, bloccaggio a leva, con angolo del tagliente utensile di 90°. Adatto per tornitura longitudinale con spallamento, tornitura conica e smussatura con inserti TN.. negativi 16, 22 o 27. Disponibile con steli da 16x16 fino a 40x40 mm. Corpo trattato per una maggiore durata dell'utensile.

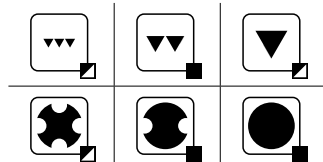
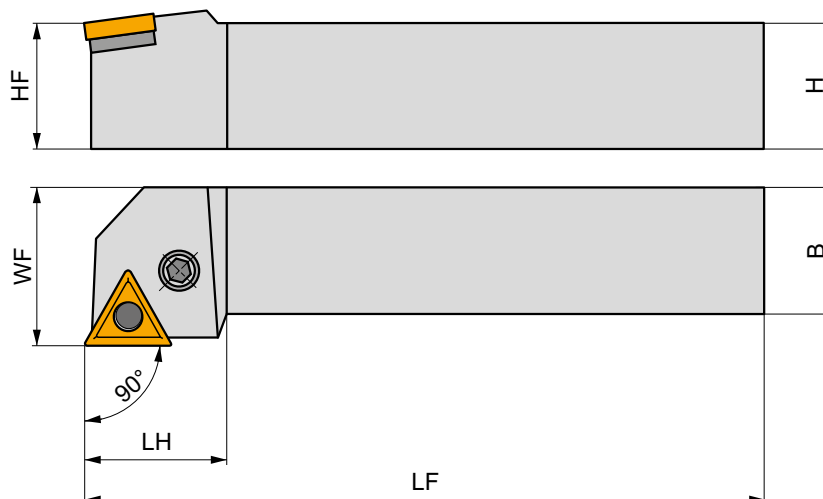
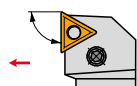
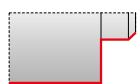

Codice prodotto	H	B	HF	WF	LF	LH	LAMS	GAMO	kg	GI	PT	
	(mm)	(mm)	(mm)	(mm)	(mm)	(mm)	(°)	(°)				
R	PTGNR 1616 H 16	16	16	16	20	100	32	-6	-6	0.24	GI024	PT11
	PTGNR 2020 K 16	20	20	20	25	125	32	-6	-6	0.40	GI024	PT10
	PTGNR 2525 M 16	25	25	25	32	150	32	-6	-6	0.73	GI024	PT10
	PTGNR 2525 M 22	25	25	25	32	150	36	-6	-6	0.75	GI025	PT20
	PTGNR 3225 P 22	32	25	32	32	170	36	-6	-6	1.11	GI025	PT20
	PTGNR 3232 P 22	32	32	32	40	170	36	-6	-6	1.39	GI025	PT20
PTGNR 4040 R 27	40	40	40	50	200	40	-6	-6	2.55	GI077	PT40	
L	PTGNL 1616 H 16	16	16	16	20	100	32	-6	-6	0.25	GI024	PT11
	PTGNL 2020 K 16	20	20	20	25	125	32	-6	-6	0.40	GI024	PT10
	PTGNL 2525 M 16	25	25	25	32	150	32	-6	-6	0.77	GI024	PT10
	PTGNL 2525 M 22	25	25	25	32	150	36	-6	-6	0.79	GI025	PT20
	PTGNL 3225 P 22	32	25	32	32	170	36	-6	-6	1.11	GI025	PT20
	PTGNL 3232 P 22	32	32	32	40	170	36	-6	-6	1.40	GI025	PT20
PTGNL 4040 R 27	40	40	40	50	200	40	-6	-6	2.40	GI077	PT40	



GI024

TN.. 1604..

GI025

TN.. 2204..

GI077

TN.. 2706..



PT10

TNU 160308

PU 01

US 34

5.0

M 6x0.75

19

NT 04

MT 04

HXK 3

PT11

TNU 160308

PU 01

US 46

5.0

M 6x0.75

13.2

NT 04

MT 04

HXK 3

PT20

TNU 220312

PU 02

US 35

6.0

M 8x1

22.5

NT 05

MT 05

HXK 4

PT40

TNU 270416

PU 04

US 36

6.0

M 8x1

26

NT 07

MT 07

HXK 4



PTTN(RL) EXT



PRAMET

P



Utensile esterno, bloccaggio a leva, angolo del tagliente utensile 60°, per inserti TN..

Utensile di tornitura esterno destro / sinistro, bloccaggio a leva con angolo del tagliente utensile di 60°. Adatto per tornitura longitudinale senza spallamento, conicità e tornitura a copiare fino a 30° e smussatura con inserti TN.. negativi 16 e 22. Disponibile con steli da 20x20 a 32x25 mm. Corpo trattato per una maggiore durata dell'utensile.

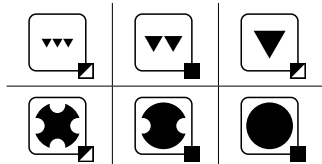
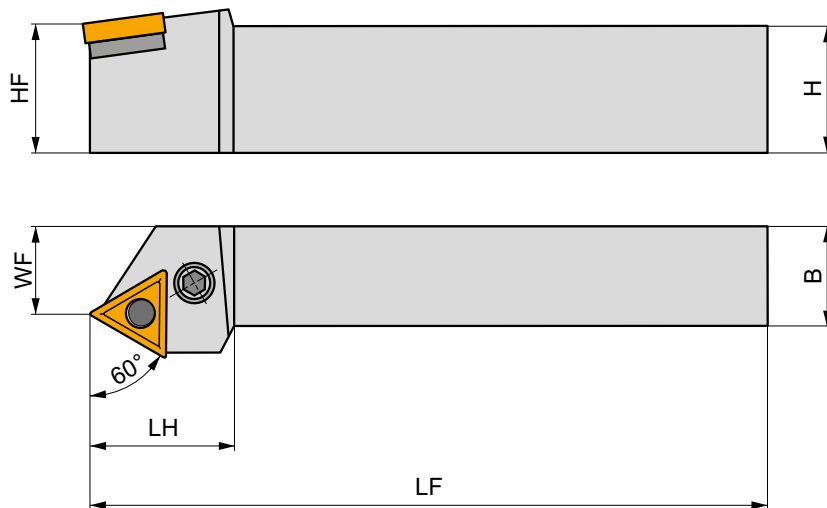
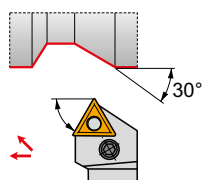

Codice prodotto	H	B	HF	WF	LF	LH	LAMS	GAMO	kg		
	(mm)	(mm)	(mm)	(mm)	(mm)	(mm)	(°)	(°)			
R PTTNR 2020 K 16	20	20	20	17	125	32	-6	-6	0.43	GI024	PT10
PTTNR 2525 M 16	25	25	25	22	150	32	-6	-6	0.63	GI024	PT10
PTTNR 2525 M 22	25	25	25	22	150	36	-6	-6	0.73	GI025	PT20
PTTNR 3225 P 22	32	25	32	22	170	36	-6	-6	1.07	GI025	PT20
L PTTNL 2020 K 16	20	20	20	17	125	32	-6	-6	0.38	GI024	PT10
PTTNL 3225 P 22	32	25	32	22	170	36	-6	-6	1.04	GI025	PT20



GI024
GI025

TN.. 1604..
TN.. 2204..



PT10
PT20

TNU 160308
TNU 220312

PU 01
PU 02

US 34
US 35

5.0
6.0

M 6x0.75
M 8x1

19
22.5

NT 04
NT 05

MT 04
MT 05

HXK 3
HXK 4

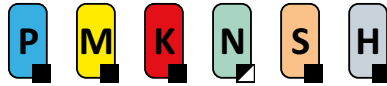
NEW
C.-DTJN(RL) EXT

D

Utensile est. PSC a cambio rapido, doppio bloccaggio, angolo del tagliente utensile 93°, inserti TN..

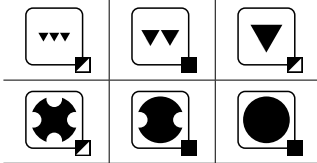
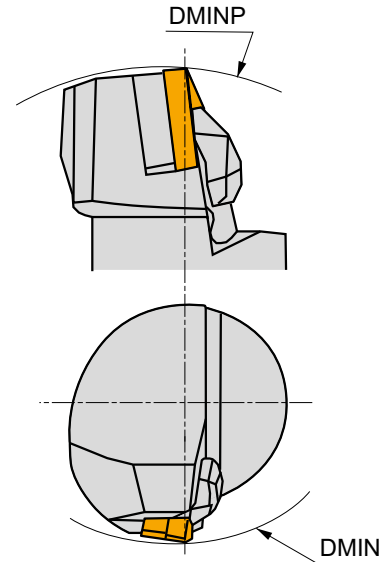
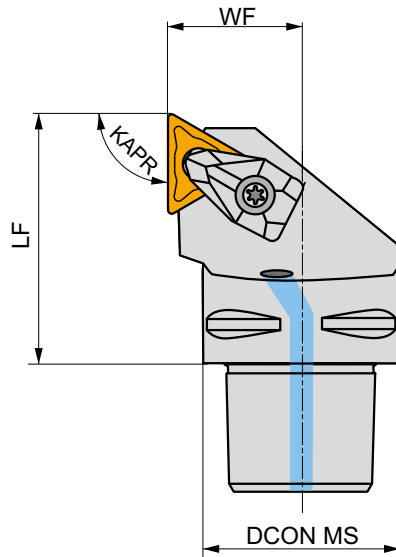
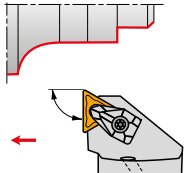
Utensile di tornitura esterno destro / sinistro, doppio bloccaggio a staffa e fori per refrigerante interno, angolo del tagliente utensile di 93°. Per tornitura longitudinale con spallamento, tornitura conica e smussatura con inserti TN .. 16 negativi. Attacco a cambio rapido PSC (Polygon Shank Coupling) dimensioni C4 e C5. Corpo trattato per una maggiore durata dell'utensile.



Codice prodotto	DCON MS (mm)	DMIN (mm)	DMINP (mm)	WF (mm)	LF (mm)	KAPR (°)	LAMIS (°)	GAMO (°)				
R C4-DTJNR-27050-16	40	110	140	27	50	93	-6	-6	✓	0.43	GI024	C-DT16
C5-DTJNR-35060-16	50	110	165	35	60	93	-6	-6	✓	0.79	GI024	C-DT16
L C4-DTJNL-27050-16	40	110	140	27	50	93	-6	-6	✓	0.44	GI024	C-DT16
C5-DTJNL-35060-16	50	110	165	35	60	93	-6	-6	✓	0.79	GI024	C-DT16



GI024



TN.. 1604..



C-DT16



DCS 09



Nm

1.7



DTS 315-02



US 2004-T09P



FLAG T09P



CN 045-01



DTFN(RL) INT



Utensile interno, doppio bloccaggio, per inserto TN... angolo del tagliente utensile 91°

Bareno destro/sinistro per tornitura interna con doppio bloccaggio a staffa e passaggio refrigerante interno, angolo del tagliente utensile 91° per inserti negativi TN...16 e 22. Diametro interno minimo tornibile Ø32 mm. Per operazioni di tornitura longitudinale, spallamento, conicità e smussi. Disponibile con stelo da Ø25 mm a Ø40 mm. Corpo trattato per una maggiore durata.

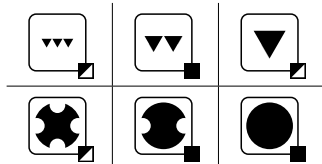
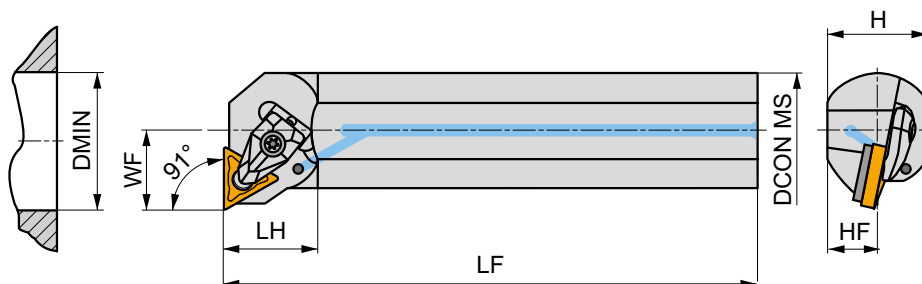
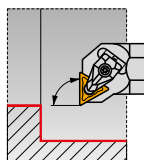

Codice prodotto	DCON MS	DMIN	WF	H	HF	LF	LH	LAMS	GAMO				
	(mm)	(mm)	(mm)	(mm)	(mm)	(mm)	(°)	(°)					
R A25T-DTFNR 16	25	32	17	23	11.5	300	32	-12	-6	✓	0.96	GI024	DT116
A32T-DTFNR 16	32	40	22	30	15	300	33	-10	-6	✓	1.67	GI024	DT116
A40T-DTFNR 22	40	50	27	37	18.5	300	36	-13	-6	✓	2.58	GI025	DT22
L A25T-DTFNL 16	25	32	17	23	11.5	300	32	-12	-6	✓	0.96	GI024	DT116
A32T-DTFNL 16	32	40	22	30	15	300	33	-10	-6	✓	1.67	GI024	DT116
A40T-DTFNL 22	40	50	27	37	18.5	300	36	-13	-6	✓	2.58	GI025	DT22



GI024

TN.. 1604..

GI025

TN.. 2204..



DT22

DCS 12

3.9

DTS 315-04

US 2002-T15P

FLAGT15P/3,5

DT116

DCS 09

1.7

DTS 316-01

US 2004-T09P

FLAGT09P



PTFN(RL) INT



PRAMET

P

Utensile interno, bloccaggio a leva, inserti TN... angolo del tagliente utensile 90°

Bareno destro/sinistro per tornitura interna con bloccaggio a leva e passaggio refrigerante interno, angolo del tagliente utensile 90° per inserti negativi TN...16 e 22. Diametro interno minimo tornibile Ø32 mm. Per operazioni di tornitura longitudinale, spallamento, conicità e smussi. Disponibile con stelo da Ø25 mm fino a Ø40 mm. Corpo trattato per una maggiore durata.

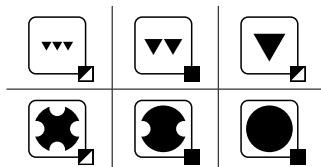
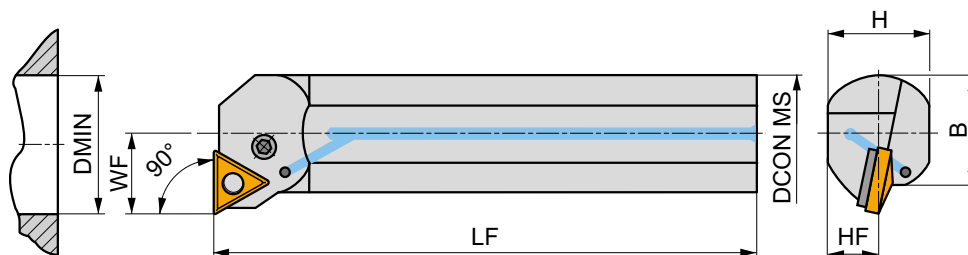
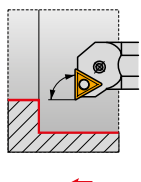

	Codice prodotto	DCON MS	DMIN	WF	H	B	LF	LAMS	GAMO				
		(mm)	(mm)	(mm)	(mm)	(mm)	(mm)	(°)	(°)				
R	A25R-PTFNR 16	25	32	17	23	23	200	-12	-6	✓	0.74	GI024	PT11
	A32S-PTFNR 16	32	40	22	30	30	250	-12	-6	✓	1.49	GI024	PT10
	A40T-PTFNR 22	40	50	27	38	38	300	-12	-6	✓	2.58	GI025	PT20
L	A25R-PTFNL 16	25	32	17	23	23	200	-12	-6	✓	0.74	GI024	PT11
	A32S-PTFNL 16	32	40	22	30	30	250	-12	-6	✓	1.48	GI024	PT10
	A40T-PTFNL 22	40	50	27	38	38	300	-12	-6	✓	2.90	GI025	PT20



GI024

TN.. 1604..

GI025

TN.. 2204..



PT10

TNU 160308

PU 01

US 34

5.0

M 6x0.75

19

NT 04

MT 04

HXK 3

PT11

TNU 160308

PU 01

US 46

5.0

M 6x0.75

13.2

NT 04

MT 04

HXK 3

PT20

TNU 220312

PU 02

US 35

6.0

M 8x1

22.5

NT 05

MT 05

HXK 4

**NEW****C.-DTFN(RL) INT**

PRAMET

D**Utensile PSC interno a cambio rapido, doppio bloccaggio per inserto TN... angolo del tagliente ut. 91°**

Utensile destro/sinistro per tornitura interna con doppio bloccaggio a staffa e passaggio refrigerante interno, angolo del tagliente utensile 91° per un'ampia gamma di applicazioni di tornitura interna con inserti negativi TN...16. Diametro interno minimo tornibile Ø32 mm. Attacco PSC (Attacco Poligonale) C4 con sporgenza di 68 mm. Corpo trattato per una maggiore durata.

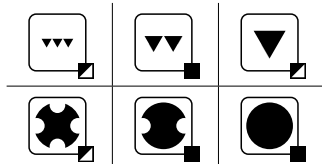
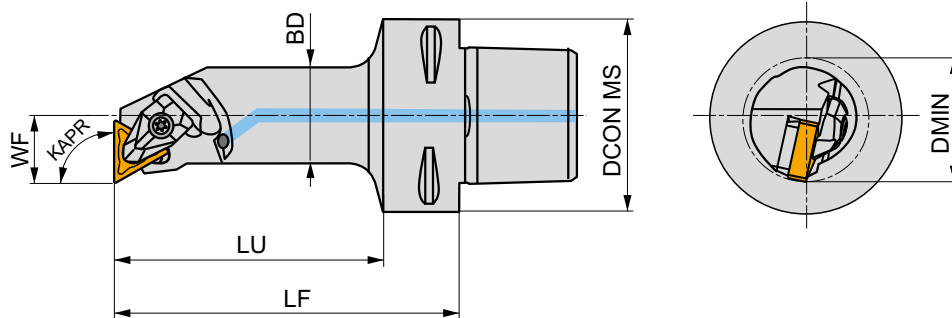
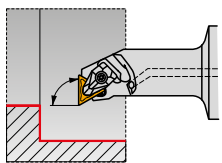

Codice prodotto	DCON MS (mm)	DMIN (mm)	WF (mm)	LF (mm)	LU (mm)	BD (mm)	KAPR (°)	LAMS (°)	GAMO (°)				
R C4-DTFNR-17090-16	40	32	17	90	68	25	91	-12	-6	✓	0.51	G1024	DT116

	G1024		TN.. 1604..
--	-------	--	-------------

	DT116		DCS 09		1.7		DTS 316-01		US 2004-T09P		FLAG T09P
--	-------	--	--------	--	-----	--	------------	--	--------------	--	-----------



INSERTI IN METALLO DURO

VNMG



356

INSERTI CER E CBN

VNGA CER



359

VNGA CBN



359

ABBINAMENTO DELLA DIMENSIONE CORRETTA (esempio)

Inserto

VNMG 160404E-SF

Portainserito

DVJNL 2020 K 16

TORNITURA ISO - ESTERNA

DVJN(RL) EXT

93°

VN..



16

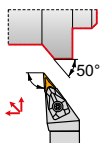

20×20
32×25

360

356 – 359

DVPN(RL) EXT

62°30'

VN..



16

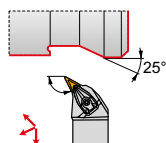

20×20
32×25

361

356 – 359

MVJN(RL) EXT

93°

VN..



16

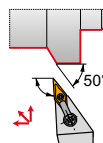

20×20
32×25

362

356 – 359

C.-DVJN(RL) EXT **NEW**

93°

VN..



16

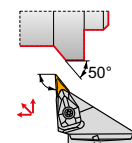

C4
C6

363

356 – 359

TORNITURA ISO INTERNA

DVUN(RL) INT

VN..



16

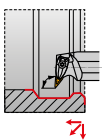

50

364

356 – 359



VNMG



	IC	D1	L	S
	(mm)	(mm)	(mm)	(mm)
1604	9.525	3.81	16.60	4.76

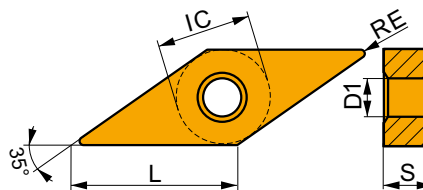

Idoneità e valori iniziali per velocità di taglio (Vc), avanzamento (f) e profondità di taglio (ap). Fare riferimento alla nostra App Machining Calculator per ulteriori calcoli.

Codice prodotto	RE	P			M			K			N			S			H		
		vc	f	ap	vc	f	ap	vc	f	ap	vc	f	ap	vc	f	ap	vc	f	ap
	(mm)	(m/min)	(mm/rev)	(mm)	(m/min)	(mm/rev)	(mm)	(m/min)	(mm/rev)	(mm)	(m/min)	(mm/rev)	(mm)	(m/min)	(mm/rev)	(mm)	(m/min)	(mm/rev)	(mm)

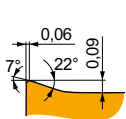

FF geometria altamente positiva per operazioni di super finitura, da taglio continuo a leggermente interrotto.

VNMG 160404E-FF	T7325	0.4	165	0.12	1.0	125	0.11	1.0	—	—	—	—	—	—	—	—	—	—	—
	T8315	0.4	150	0.12	1.0	90	0.11	1.0	140	0.12	1.0	—	—	—	—	—	—	—	—
	T8330	0.4	140	0.12	1.0	80	0.11	1.0	130	0.12	1.0	—	—	—	—	—	—	—	—
	T8430	0.4	175	0.12	1.0	95	0.11	1.0	140	0.12	1.0	—	—	—	—	—	—	—	—

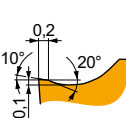

FM geometria positiva per operazioni da finitura fino a semi sgrossatura, da taglio continuo a leggermente interrotto.

VNMG 160404E-FM	T7325	0.4	140	0.20	1.2	105	0.18	1.2	—	—	—	45	0.20	1.0	—	—	—	—	—
	T8330	0.4	120	0.20	1.2	70	0.18	1.2	110	0.20	1.2	30	0.14	1.0	—	—	—	—	—
	T8430	0.4	135	0.20	1.2	75	0.18	1.2	110	0.20	1.2	25	0.14	1.0	—	—	—	—	—
	T9310	0.4	210	0.20	1.2	—	—	—	195	0.20	1.2	—	—	—	—	—	—	—	—
	T9315	0.4	190	0.20	1.2	—	—	—	180	0.20	1.2	—	—	—	—	—	—	—	—
	T9325	0.4	170	0.20	1.2	100	0.18	1.2	160	0.20	1.2	35	0.20	1.0	—	—	—	—	—
VNMG 160408E-FM	T7325	0.8	160	0.20	1.4	120	0.18	1.4	—	—	—	50	0.16	1.1	—	—	—	—	—
	T8330	0.8	145	0.20	1.4	85	0.18	1.4	135	0.20	1.4	35	0.16	1.1	—	—	—	—	—
	T8430	0.8	165	0.20	1.4	90	0.18	1.4	135	0.20	1.4	35	0.16	1.1	—	—	—	—	—
	T9310	0.8	245	0.20	1.4	—	—	—	230	0.20	1.4	—	—	—	—	—	—	—	—
	T9315	0.8	220	0.20	1.4	—	—	—	205	0.20	1.4	—	—	—	—	—	—	—	—
	T9325	0.8	200	0.20	1.4	120	0.18	1.4	190	0.20	1.4	45	0.16	1.1	—	—	—	—	—
VNMG 160412E-FM	T7325	1.2	165	0.22	1.4	125	0.20	1.4	—	—	—	50	0.18	1.1	—	—	—	—	—
	T8330	1.2	150	0.22	1.4	90	0.20	1.4	140	0.22	1.4	35	0.18	1.1	—	—	—	—	—
	T8430	1.2	165	0.22	1.4	90	0.20	1.4	135	0.22	1.4	35	0.18	1.1	—	—	—	—	—
	T9315	1.2	225	0.22	1.4	—	—	—	210	0.22	1.4	—	—	—	—	—	—	—	—
	T9325	1.2	200	0.22	1.4	120	0.20	1.4	190	0.22	1.4	45	0.18	1.1	—	—	—	—	—

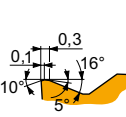

M geometria per operazioni da finitura fino a semi sgrossatura, da taglio continuo a interrotto.

VNMG 160404E-M	T5315	0.4	180	0.20	1.2	—	—	—	170	0.20	1.2	—	—	—	35	0.15	1.0	—	—
	T9315	0.4	170	0.20	1.2	—	—	—	160	0.20	1.2	—	—	—	30	0.15	1.0	—	—
	T9325	0.4	155	0.20	1.2	—	—	—	145	0.20	1.2	—	—	—	—	—	—	—	—
	T9335	0.4	130	0.20	1.2	—	—	—	—	—	—	—	—	—	—	—	—	—	—
VNMG 160408E-M	T5305	0.8	205	0.30	1.4	—	—	—	190	0.30	1.4	—	—	—	40	0.15	1.0	—	—
	T5315	0.8	185	0.30	1.4	—	—	—	175	0.30	1.4	—	—	—	35	0.15	1.0	—	—
	T9310	0.8	185	0.30	1.4	—	—	—	175	0.30	1.4	—	—	—	35	0.15	1.0	—	—
	T9315	0.8	170	0.30	1.4	—	—	—	160	0.30	1.4	—	—	—	30	0.15	1.0	—	—
	T9325	0.8	150	0.30	1.4	—	—	—	140	0.30	1.4	—	—	—	—	—	—	—	—
	T9335	0.8	130	0.30	1.4	—	—	—	—	—	—	—	—	—	—	—	—	—	—
VNMG 160412E-M	T9325	1.2	140	0.40	1.4	—	—	—	130	0.40	1.4	—	—	—	—	—	—	—	—



Idoneità e valori iniziali per velocità di taglio (Vc), avanzamento (f) e profondità di taglio (ap). Fare riferimento alla nostra App Machining Calculator per ulteriori calcoli.

Codice prodotto	RE (mm)	P			M			K			N			S			H		
		vc (m/min)	f (mm/rev)	ap (mm)	vc (m/min)	f (mm/rev)	ap (mm)	vc (m/min)	f (mm/rev)	ap (mm)	vc (m/min)	f (mm/rev)	ap (mm)	vc (m/min)	f (mm/rev)	ap (mm)	vc (m/min)	f (mm/rev)	ap (mm)

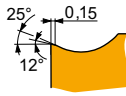

NF geometria con design altamente positivo per operazioni da finitura fino a medie lavorazioni, taglio continuo.

VNMG 160404E-NF	T6310	0.4	140	0.12	1.2	100	0.11	1.2	110	0.12	1.2	420	0.14	1.2	40	0.11	1.0	-	-	-
	T7325	0.4	140	0.18	1.2	105	0.16	1.2	-	-	-	-	-	-	45	0.16	1.0	-	-	-
	T7335	0.4	140	0.18	1.2	105	0.16	1.2	-	-	-	-	-	-	45	0.16	1.0	-	-	-
	T8315	0.4	150	0.12	1.2	90	0.11	1.2	140	0.12	1.2	450	0.14	1.2	35	0.11	1.0	-	-	-
	T8330	0.4	140	0.12	1.2	80	0.11	1.2	130	0.12	1.2	420	0.14	1.2	35	0.11	1.0	-	-	-
	T8430	0.4	175	0.12	1.2	95	0.11	1.2	140	0.12	1.2	480	0.14	1.2	35	0.11	1.0	-	-	-
	T9315	0.4	235	0.12	1.2	-	-	-	220	0.12	1.2	-	-	-	-	-	-	-	-	-
	T9325	0.4	180	0.18	1.2	105	0.16	1.2	170	0.18	1.2	-	-	-	40	0.16	1.0	-	-	-
	VNMG 160408E-NF	T6310	0.8	145	0.17	1.4	100	0.15	1.4	115	0.17	1.4	435	0.20	1.4	40	0.14	1.1	-	-
T7325		0.8	165	0.18	1.4	125	0.16	1.4	-	-	-	-	-	50	0.16	1.1	-	-	-	
T7335		0.8	160	0.18	1.4	120	0.16	1.4	-	-	-	-	-	50	0.16	1.1	-	-	-	
T8315		0.8	160	0.17	1.4	95	0.15	1.4	150	0.17	1.4	480	0.20	1.4	40	0.14	1.1	-	-	-
T8330		0.8	150	0.17	1.4	90	0.15	1.4	140	0.17	1.4	450	0.20	1.4	35	0.14	1.1	-	-	-
T8430		0.8	175	0.17	1.4	95	0.15	1.4	140	0.17	1.4	480	0.20	1.4	35	0.14	1.1	-	-	-
T9315		0.8	240	0.17	1.4	-	-	-	225	0.17	1.4	-	-	-	-	-	-	-	-	-
T9325		0.8	210	0.18	1.4	125	0.16	1.4	195	0.18	1.4	-	-	-	45	0.16	1.1	-	-	-

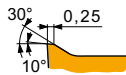

NM geometria con design altamente positivo per operazioni di finitura, media sgrassatura, taglio continuo.

VNMG 160404E-NM	T7325	0.4	145	0.20	1.2	110	0.18	1.2	-	-	-	-	-	45	0.20	1.0	-	-	-	
	T7335	0.4	140	0.20	1.2	105	0.18	1.2	-	-	-	-	-	45	0.20	1.0	-	-	-	
	T8315	0.4	135	0.20	1.2	80	0.18	1.2	-	-	-	405	0.24	1.2	30	0.20	1.0	-	-	-
	T8330	0.4	125	0.20	1.2	75	0.18	1.2	-	-	-	375	0.24	1.2	30	0.20	1.0	-	-	-
	T8430	0.4	145	0.20	1.2	80	0.18	1.2	-	-	-	405	0.24	1.2	30	0.20	1.0	-	-	-
	T9325	0.4	180	0.20	1.2	105	0.18	1.2	-	-	-	-	-	40	0.20	1.0	-	-	-	
VNMG 160408E-NM	T7325	0.8	160	0.25	1.4	120	0.23	1.4	-	-	-	-	-	50	0.20	1.1	-	-	-	
	T7335	0.8	155	0.25	1.4	120	0.23	1.4	-	-	-	-	-	50	0.20	1.1	-	-	-	
	T8315	0.8	145	0.25	1.4	85	0.23	1.4	-	-	-	435	0.30	1.4	35	0.20	1.1	-	-	-
	T8330	0.8	140	0.25	1.4	80	0.23	1.4	-	-	-	420	0.30	1.4	35	0.20	1.1	-	-	-
	T8430	0.8	155	0.25	1.4	85	0.23	1.4	-	-	-	435	0.30	1.4	30	0.20	1.1	-	-	-
	T9325	0.8	190	0.25	1.4	110	0.23	1.4	-	-	-	-	-	40	0.20	1.1	-	-	-	

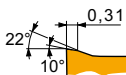

NMR geometria con design positivo per operazioni da media fino a sgrassatura, taglio continuo.

VNMG 160404E-NMR	T7325	0.4	125	0.20	1.2	95	0.18	1.2	-	-	-	-	-	40	0.18	1.0	-	-	-
	T7335	0.4	120	0.20	1.2	90	0.18	1.2	-	-	-	-	-	35	0.18	1.0	-	-	-
	T9325	0.4	155	0.20	1.2	90	0.18	1.2	-	-	-	-	-	30	0.18	1.0	-	-	-
VNMG 160408E-NMR	T7325	0.8	130	0.30	1.4	100	0.27	1.4	-	-	-	-	-	40	0.24	1.1	-	-	-
	T7335	0.8	125	0.30	1.4	95	0.27	1.4	-	-	-	-	-	40	0.24	1.1	-	-	-
	T8430	0.8	125	0.30	1.4	65	0.27	1.4	-	-	-	-	-	25	0.24	1.1	-	-	-
	T9315	0.8	170	0.30	1.4	-	-	-	-	-	-	-	-	-	-	-	-	-	-
	T9325	0.8	150	0.30	1.4	90	0.27	1.4	-	-	-	-	-	30	0.24	1.1	-	-	-
VNMG 160412E-NMR	T7325	1.2	140	0.30	1.4	105	0.27	1.4	-	-	-	-	-	45	0.24	1.1	-	-	-
	T8330	1.2	120	0.30	1.4	70	0.27	1.4	-	-	-	-	-	30	0.24	1.1	-	-	-
	T8430	1.2	130	0.30	1.4	70	0.27	1.4	-	-	-	-	-	25	0.24	1.1	-	-	-
	T9325	1.2	160	0.30	1.4	95	0.27	1.4	-	-	-	-	-	35	0.24	1.1	-	-	-



Idoneità e valori iniziali per velocità di taglio (V_c), avanzamento (f) e profondità di taglio (a_p). Fare riferimento alla nostra App Machining Calculator per ulteriori calcoli.

Codice prodotto	RE  (mm)	P			M			K			N			S			H		
		v_c (m/min)	f (mm/rev)	a_p (mm)	v_c (m/min)	f (mm/rev)	a_p (mm)	v_c (m/min)	f (mm/rev)	a_p (mm)	v_c (m/min)	f (mm/rev)	a_p (mm)	v_c (m/min)	f (mm/rev)	a_p (mm)	v_c (m/min)	f (mm/rev)	a_p (mm)

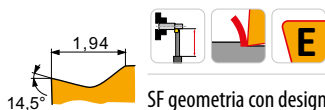

SF geometria con design positivo per operazioni di finitura su pareti sottili, taglio continuo.

VNMG 160404E-SF	T6310	0.4	■	135	0.12	1.2	■	95	0.11	1.2	■	105	0.12	1.2	▣	405	0.14	1.2	■	40	0.11	1.0	■	25	0.15	1.0
	T7325	0.4	▣	140	0.17	1.2	■	105	0.15	1.2	■	—	—	—	■	—	—	—	■	45	0.15	1.0	■	—	—	—
	T8315	0.4	▣	140	0.12	1.2	■	80	0.11	1.2	■	130	0.12	1.2	▣	420	0.14	1.2	▣	35	0.11	1.0	■	25	0.15	1.0
	T8330	0.4	■	135	0.12	1.2	■	80	0.11	1.2	■	125	0.12	1.2	▣	405	0.14	1.2	▣	30	0.11	1.0	▣	25	0.15	1.0
	T8430	0.4	■	165	0.12	1.2	■	90	0.11	1.2	▣	135	0.12	1.2	▣	450	0.14	1.2	▣	35	0.11	1.0	▣	25	0.15	1.0
	T9315	0.4	■	225	0.12	1.2	■	—	—	—	▣	210	0.12	1.2	■	—	—	—	■	—	—	—	▣	45	0.15	1.0
	T9325	0.4	■	175	0.17	1.2	■	105	0.15	1.2	▣	165	0.17	1.2	■	—	—	—	▣	35	0.15	1.0	■	—	—	—
VNMG 160408E-SF	T6310	0.8	■	140	0.17	1.4	■	100	0.15	1.4	■	110	0.17	1.4	▣	420	0.20	1.4	■	40	0.14	1.1	■	25	0.15	1.0
	T8315	0.8	▣	150	0.17	1.4	■	90	0.15	1.4	■	140	0.17	1.4	▣	450	0.20	1.4	▣	35	0.14	1.1	■	30	0.15	1.0
	T8330	0.8	■	145	0.17	1.4	■	85	0.15	1.4	■	135	0.17	1.4	▣	435	0.20	1.4	▣	35	0.14	1.1	▣	25	0.15	1.0
	T8430	0.8	■	165	0.17	1.4	■	90	0.15	1.4	▣	135	0.17	1.4	▣	450	0.20	1.4	▣	35	0.14	1.1	▣	25	0.15	1.0
	T9315	0.8	■	230	0.17	1.4	■	—	—	—	▣	215	0.17	1.4	■	—	—	—	■	—	—	—	▣	45	0.15	1.0
	T9325	0.8	■	205	0.17	1.4	■	120	0.15	1.4	▣	190	0.17	1.4	■	—	—	—	▣	45	0.15	1.1	■	—	—	—
VNMG 160412E-SF	T6310	1.2	■	145	0.20	1.4	■	100	0.18	1.4	■	115	0.20	1.4	▣	435	0.24	1.4	■	40	0.16	1.1	■	25	0.15	1.0
	T7325	1.2	▣	165	0.20	1.4	■	125	0.18	1.4	■	—	—	—	■	—	—	—	■	50	0.16	1.1	■	—	—	—



SM geometria con design positivo per medie lavorazioni, da taglio continuo a interrotto.

VNMG 160404E-SM	T6310	0.4	■	120	0.18	1.2	■	85	0.16	1.2	■	95	0.18	1.2	▣	360	0.22	1.2	■	35	0.16	1.0	▣	20	0.15	1.0
	T7325	0.4	▣	135	0.18	1.2	■	105	0.16	1.2	■	—	—	—	■	—	—	—	■	40	0.16	1.0	■	—	—	—
	T7335	0.4	▣	135	0.18	1.2	■	105	0.16	1.2	■	—	—	—	■	—	—	—	■	40	0.16	1.0	■	—	—	—
	T8330	0.4	■	120	0.18	1.2	■	70	0.16	1.2	■	110	0.18	1.2	▣	360	0.22	1.2	▣	30	0.16	1.0	▣	20	0.15	1.0
	T8430	0.4	■	135	0.18	1.2	■	75	0.16	1.2	▣	110	0.18	1.2	▣	375	0.22	1.2	▣	25	0.16	1.0	▣	20	0.15	1.0
	T9315	0.4	■	190	0.18	1.2	■	—	—	—	▣	180	0.18	1.2	■	—	—	—	■	—	—	—	▣	35	0.15	1.0
	T9325	0.4	■	170	0.18	1.2	■	100	0.16	1.2	▣	160	0.18	1.2	■	—	—	—	▣	35	0.16	1.0	■	—	—	—
VNMG 160408E-SM	T6310	0.8	■	125	0.25	1.4	■	90	0.23	1.4	■	100	0.25	1.4	▣	375	0.30	1.4	■	35	0.20	1.1	▣	25	0.15	1.0
	T7325	0.8	▣	145	0.25	1.4	■	110	0.23	1.4	■	—	—	—	■	—	—	—	■	45	0.20	1.1	■	—	—	—
	T8330	0.8	■	125	0.25	1.4	■	75	0.23	1.4	■	115	0.25	1.4	▣	375	0.30	1.4	▣	30	0.20	1.1	▣	25	0.15	1.0
	T8430	0.8	■	140	0.25	1.4	■	75	0.23	1.4	▣	115	0.25	1.4	▣	390	0.30	1.4	▣	30	0.20	1.1	▣	20	0.15	1.0
	T9315	0.8	■	195	0.25	1.4	■	—	—	—	▣	185	0.25	1.4	■	—	—	—	■	—	—	—	▣	35	0.15	1.0
	T9325	0.8	■	170	0.25	1.4	■	100	0.23	1.4	▣	160	0.25	1.4	■	—	—	—	▣	35	0.20	1.1	■	—	—	—
VNMG 160412E-SM	T6310	1.2	■	125	0.30	1.4	■	90	0.27	1.4	■	100	0.30	1.4	▣	375	0.36	1.4	■	35	0.24	1.1	▣	25	0.15	1.0



VNGA CER

	IC (mm)	D1 (mm)	L (mm)	S (mm)
1604	9.525	3.81	16.60	4.76

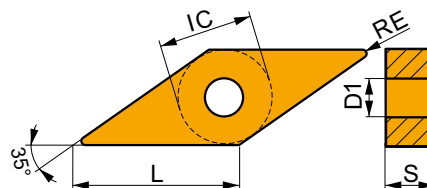

Idoneità e valori iniziali per velocità di taglio (Vc), avanzamento (f) e profondità di taglio (ap). Fare riferimento alla nostra App Machining Calculator per ulteriori calcoli.

Codice prodotto	RE (mm)	P			M			K			N			S			H		
		vc (m/min)	f (mm/rev)	ap (mm)	vc (m/min)	f (mm/rev)	ap (mm)	vc (m/min)	f (mm/rev)	ap (mm)	vc (m/min)	f (mm/rev)	ap (mm)	vc (m/min)	f (mm/rev)	ap (mm)	vc (m/min)	f (mm/rev)	ap (mm)

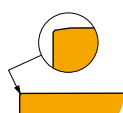

Adatta per lavorazioni con elevata velocità e taglio continuo.

VNGA 160404 T01020	TC100	0.4	–	–	–	–	–	–	–	–	–	–	–	–	–	–	–	–	–
VNGA 160408 T01020	TC100	0.8	–	–	–	–	–	–	–	–	–	–	–	–	–	–	–	–	–

VNGA CBN

	IC (mm)	D1 (mm)	L (mm)	S (mm)
1604	9.525	3.81	16.00	4.76

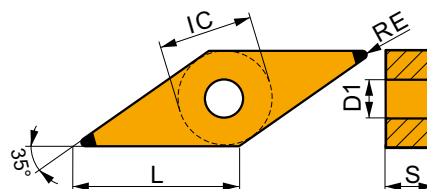

Idoneità e valori iniziali per velocità di taglio (Vc), avanzamento (f) e profondità di taglio (ap). Fare riferimento alla nostra App Machining Calculator per ulteriori calcoli.

Codice prodotto	RE (mm)	P			M			K			N			S			H		
		vc (m/min)	f (mm/rev)	ap (mm)	vc (m/min)	f (mm/rev)	ap (mm)	vc (m/min)	f (mm/rev)	ap (mm)	vc (m/min)	f (mm/rev)	ap (mm)	vc (m/min)	f (mm/rev)	ap (mm)	vc (m/min)	f (mm/rev)	ap (mm)

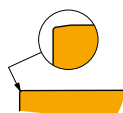

Adatta per operazioni di finitura e taglio continuo.

VNGA 160404S01020B	TB310	0.4	–	–	–	–	–	–	–	–	–	–	–	–	–	–	–	–	–
VNGA 160408S01020B	TB310	0.8	–	–	–	–	–	–	–	–	–	–	–	–	–	–	–	–	–



DVJN(RL) EXT



Utensile esterno, doppio bloccaggio, angolo del tagliente utensile 93°, inserti VN..

Utensile di tornitura esterno, destro / sinistro, doppio bloccaggio a staffa, con angolo del tagliente utensile di 93°. Adatto per tornitura longitudinale con spallamento, tornitura a copiare e conica e smussatura con inserti VN .. 16 negativi. Disponibile con stelo da 20x20 a 32x25mm. Corpo trattato per una maggiore durata dell'utensile.

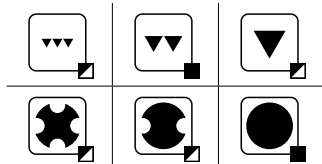
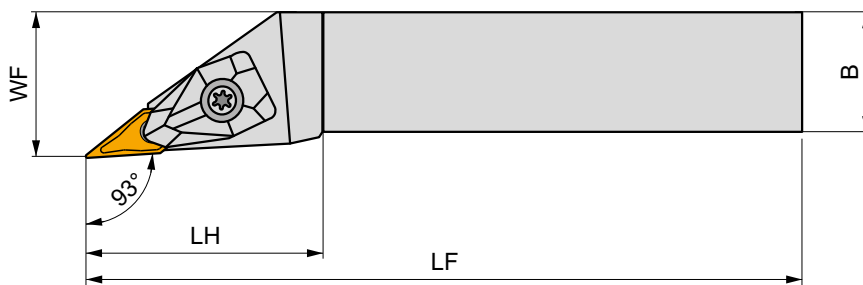
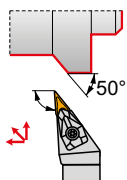

Codice prodotto	H	B	HF	WF	LF	LH	LAMS	GAMO	kg			
	(mm)	(mm)	(mm)	(mm)	(mm)	(mm)	(°)	(°)				
R	DVJNR 2020 K 16	20	20	20	25	125	46.4	-13	-4	0.43	G1048	DV16
	DVJNR 2525 M 16	25	25	25	32	150	46.4	-13	-4	0.75	G1048	DV16
	DVJNR 3225 P 16	32	25	32	32	170	46.4	-13	-4	1.05	G1048	DV16
L	DVJNL 2020 K 16	20	20	20	25	125	46.4	-13	-4	0.43	G1048	DV16
	DVJNL 2525 M 16	25	25	25	32	150	46.4	-13	-4	0.75	G1048	DV16
	DVJNL 3225 P 16	32	25	32	32	170	46.4	-13	-4	1.06	G1048	DV16



G1048



VN.. 1604..



DV16



DCS 16V



3.0



DVS 269-01



US 2009-T15P



FLAGT15P/3,5



DVPN(RL) EXT



Utensile esterno, doppio bloccaggio, angolo del tagliente utensile 117,5°, inserti VN..

Utensile esterno di tornitura destro / sinistro, doppio bloccaggio a staffa, con angolo del tagliente dell'utensile 117,5°. Adatto per tornitura longitudinale e sfacciatura con spallamento, tornitura a copiare, conica e smussatura con inserti VN .. 16 negativi. Disponibile con stelo 25x25 e 32x25 mm. Corpo trattato per una maggiore durata dell'utensile.

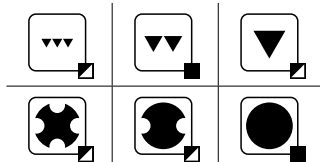
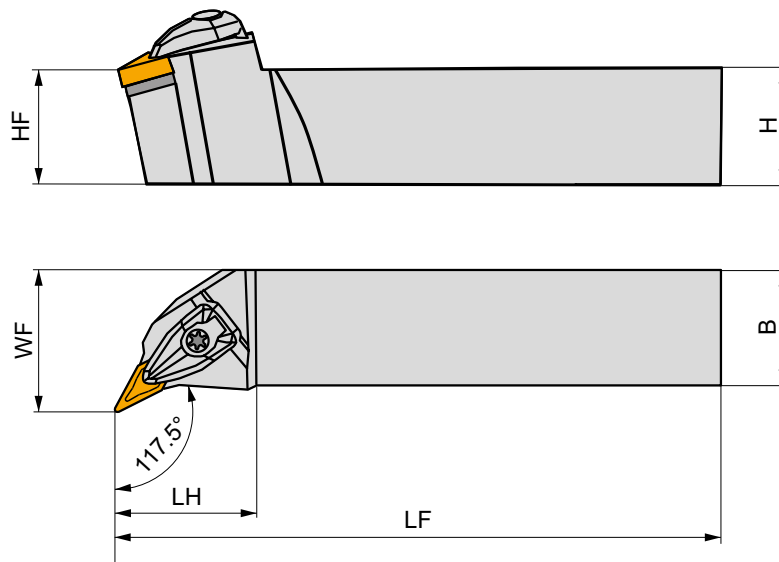
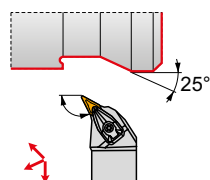

Codice prodotto		H	B	HF	WF	LF	LH	LAMS	GAMO	kg		
		(mm)	(mm)	(mm)	(mm)	(mm)	(mm)	(°)	(°)			
R	DVPNR 2525 M 16	25	25	25	32	150	39.2	-13	-4	0.75	GI048	DV16
	DVPNR 3225 P 16	32	25	32	32	170	39.2	-13	-4	1.06	GI048	DV16
L	DVPNL 2525 M 16	25	25	25	32	150	39.2	-13	-4	0.74	GI048	DV16
	DVPNL 3225 P 16	32	25	32	32	170	39.2	-13	-4	1.06	GI048	DV16



GI048



VN.. 1604..



DV16



DCS 16V



Nm

3.0



DVS 269-01



US 2009-T15P



FLAG T15P/3,5



MVJN(RL) EXT



PRAMET

M



Utensile esterno, bloccaggio perno e staffa, angolo del tagliente utensile 93°, inserti VN..

Utensile di tornitura esterno destro / sinistro, bloccaggio perno e staffa con angolo del tagliente utensile di 93°. Adatto per tornitura longitudinale con spallamento, tornitura a copiare fino a 50°, tornitura conica e smussi con inserto VN.. 16 negativo. Disponibile con dimensioni stelo da 20x20 fino a 32x25 mm. Corpo trattato per una maggiore durata dell'utensile.

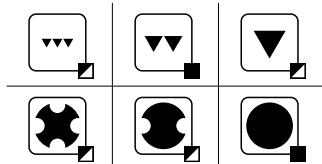
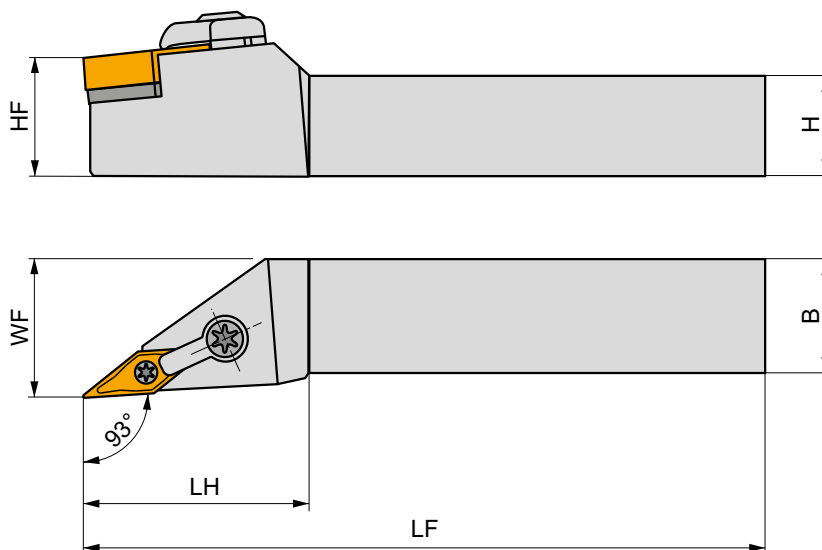
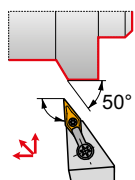

Codice prodotto	H	B	HF	WF	LF	LH	LAMS	GAMO	kg		
	(mm)	(mm)	(mm)	(mm)	(mm)	(mm)	(°)	(°)			
R MVJNR 2020 K 16-A	20	20	20	25	125	41	-4.5	-13.5	0.40	GI048	MV2
MVJNR 2525 M 16-A	25	25	25	32	150	41	-4.5	-13.5	0.70	GI048	MV2
MVJNR 3225 P 16-A	32	25	32	32	170	41	-4.5	-13.5	0.98	GI048	MV2
L MVJNL 2020 K 16-A	20	20	20	25	125	41	-4.5	-13.5	0.40	GI048	MV2
MVJNL 2525 M 16-A	25	25	25	32	150	41	-4.5	-13.5	0.70	GI048	MV2
MVJNL 3225 P 16-A	32	25	32	32	170	41	-4.5	-13.5	0.96	GI048	MV2



GI048



VN.. 1604..



MV2



UPC22



MVN 160316



UP 0909-T09P



2.0



PS 6026-T09P



2.0



FLAG T09P

**NEW****C.-DVJN(RL) EXT**

PRAMET

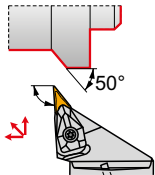
D**Utensile esterno PSC a cambio rapido, doppio bloccaggio, angolo del tagliente 93°, inserti VN..**

Utensile di tornitura esterno destro / sinistro, doppio bloccaggio a staffa e fori per refrigerante interno, angolo del tagliente utensile di 93° per tornitura longitudinale con spallamento, tornitura a copiare e conica e smussatura con inserti VN .. 16 negativi. Attacco a cambio rapido PSC (Polygon Shank Coupling) da C4 a C6. Corpo trattato per una maggiore durata dell'utensile.

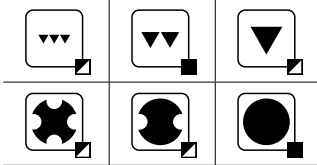
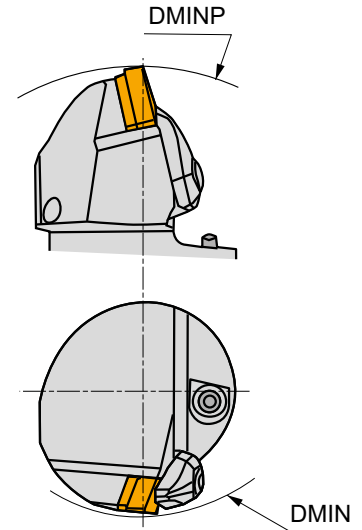
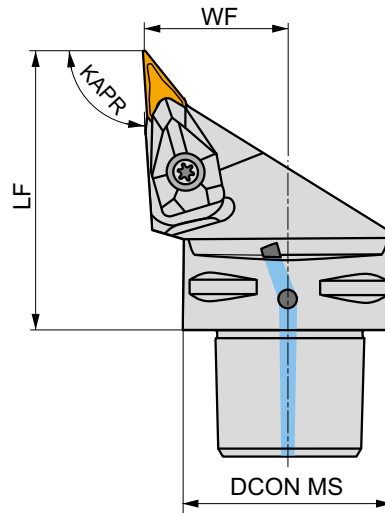

Codice prodotto	DCON MS	DMIN	DMINP	WF	LF	KAPR	LAMS	GAMO					
	(mm)	(mm)	(mm)	(mm)	(mm)	(°)	(°)	(°)					
R	C4-DVJNR-27062-16	40	60	152	27	62	93	-13	-4	✓	0.45	GI048	C-DV16-1
	C5-DVJNR-35065-16	50	65	170	35	65	93	-13	-4	✓	0.47	GI048	C-DV16-2
	C6-DVJNR-45065-16	63	81	190	45	65	93	-13	-4	✓	1.13	GI048	C-DV16-2
L	C4-DVJNL-27062-16	40	60	152	27	62	93	-13	-4	✓	0.45	GI048	C-DV16-1
	C5-DVJNL-35065-16	50	65	170	35	65	93	-13	-4	✓	0.72	GI048	C-DV16-2
	C6-DVJNL-45065-16	63	81	190	45	65	93	-13	-4	✓	1.13	GI048	C-DV16-2



GI048



VN.. 1604..



Nm



C-DV16-1

DCS 16V

3.0

DVS 269-01

US 2009-T15P

FLAGT15P/3,5

CN 034-01

C-DV16-2

DCS 16V

3.0

DVS 269-01

US 2009-T15P

FLAGT15P/3,5

CN 034-02



DVUN(RL) INT



Utensile interno, doppio bloccaggio, per inserto VN... angolo del tagliente utensile 93°

Bareno destro/sinistro per tornitura interna con doppio bloccaggio a staffa e passaggio refrigerante interno, angolo del tagliente utensile 93° per inserto negativo VN...16. Diametro interno minimo tornibile Ø50 mm. Per operazioni di tornitura longitudinale, spallamento, conicità e smussi. Disponibile solamente con stelo Ø40 mm. Corpo trattato per una maggiore durata.

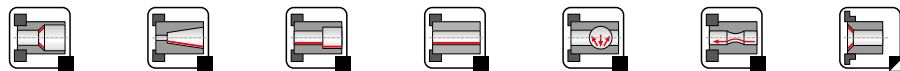
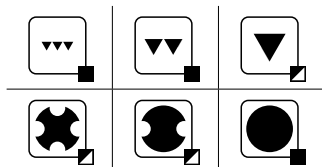
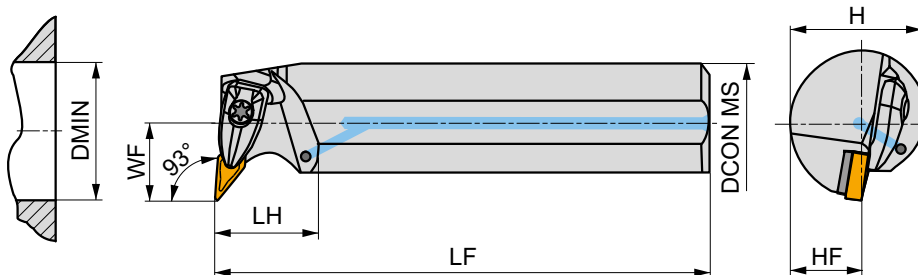
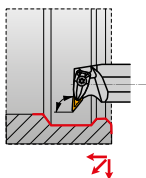

Codice prodotto	DCON MS (mm)	DMIN (mm)	WF (mm)	H (mm)	HF (mm)	LF (mm)	LH (mm)	LAMS (°)	GAMO (°)		kg		
R A40T-DVUNR 16	40	50	27	37	18,5	300	36	-9	-6	✓	2,59	GI048	DV16
L A40T-DVUNL 16	40	50	27	37	18,5	300	36	-9	-6	✓	2,59	GI048	DV16



GI048



VN.. 1604..



DV16



DCS 16V



3.0



DVS 269-01



US 2009-T15P



FLAG T15P/3,5



WN

06/ 08/ 10/ 13

INSERTI IN METALLO DURO

WNMA



366

WNMG



366

WNMM



375

INSERTI CER E CBN

WNGA CBN



376

ABBINAMENTO DELLA DIMENSIONE CORRETTA (esempio)

Inserto

WNMA 080408

Portainsero

DWLNL 2020 K 08

TORNITURA ISO - ESTERNA

DWLN(RL) EXT

95°

WN..

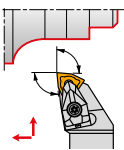
06
08
10
13
 $\frac{16 \times 16}{40 \times 40}$

377

366 - 376

MWLN(RL) EXT

95°

WN..

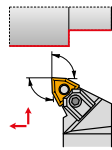

08

 $\frac{25 \times 25}{40 \times 40}$

379

366 - 376

PWLN(RL) EXT

95°

WN..

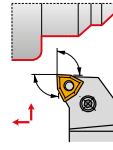
06
08
 $\frac{16 \times 16}{32 \times 25}$

380

366 - 376

C.-DWLN(RL) EXT **NEW**

95°

WN..

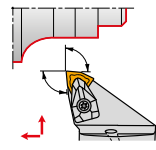
06
08
 $\frac{C4}{C6}$

381

366 - 376

TORNITURA ISO INTERNA

DWLN(RL) INT

95°

WN..

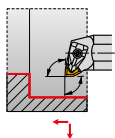
06
08
 $\frac{32}{63}$

382

366 - 376

PWLN(RL) INT

95°

WN..

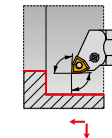
06
08
 $\frac{20}{80}$

383

366 - 376

C.-DWLN(RL) INT **NEW**

95°

WN..

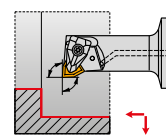
06
08
 $\frac{27}{33}$

385

366 - 376



WNMA

	IC	D1	L	S
	(mm)	(mm)	(mm)	(mm)
0804	12.700	5.16	8.70	4.76

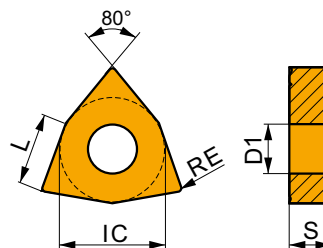

Idoneità e valori iniziali per velocità di taglio (Vc), avanzamento (f) e profondità di taglio (ap). Fare riferimento alla nostra App Machining Calculator per ulteriori calcoli.

Codice prodotto	RE	P			M			K			N			S			H		
		vc	f	ap	vc	f	ap	vc	f	ap	vc	f	ap	vc	f	ap	vc	f	ap
	(mm)	(m/min)	(mm/rev)	(mm)	(m/min)	(mm/rev)	(mm)	(m/min)	(mm/rev)	(mm)	(m/min)	(mm/rev)	(mm)	(m/min)	(mm/rev)	(mm)	(m/min)	(mm/rev)	(mm)

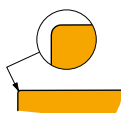

Adatta per operazioni da finitura fino a semi sgrossatura, da taglio continuo a leggermente interrotto.

WNMA 080404	T5305	0.4	–	–	–	–	–	–	■	235	0.10	4.0	–	–	–	–	–	–	■	50	0.15	1.0
	T5315	0.4	–	–	–	–	–	–	■	200	0.10	4.0	–	–	–	–	–	–	■	40	0.15	1.0
WNMA 080408	T5305	0.8	–	–	–	–	–	–	■	220	0.20	4.0	–	–	–	–	–	–	■	45	0.15	1.0
	T5315	0.8	–	–	–	–	–	–	■	190	0.20	4.0	–	–	–	–	–	–	■	40	0.15	1.0
	T6310	0.8	–	–	–	–	–	–	■	100	0.20	4.0	–	–	–	–	–	–	■	25	0.15	1.0
WNMA 080412	T5305	1.2	–	–	–	–	–	–	■	195	0.30	4.0	–	–	–	–	–	–	■	40	0.15	1.0
	T5315	1.2	–	–	–	–	–	–	■	180	0.30	4.0	–	–	–	–	–	–	■	35	0.15	1.0
	T6310	1.2	–	–	–	–	–	–	■	95	0.30	4.0	–	–	–	–	–	–	■	20	0.15	1.0

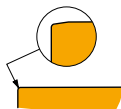

Adatta per operazioni da finitura fino a semi sgrossatura, da taglio continuo a leggermente interrotto.

WNMA 080408S	T5305	0.8	–	–	–	–	–	–	■	220	0.20	4.0	–	–	–	–	–	–	■	45	0.15	1.0
---------------------	--------------	-----	---	---	---	---	---	---	---	-----	------	-----	---	---	---	---	---	---	---	----	------	-----

WNMG

	IC	D1	L	S
	(mm)	(mm)	(mm)	(mm)
0604	9.525	3.81	6.50	4.76
06T3	9.525	3.81	6.50	3.97
0804	12.700	5.16	8.70	4.76

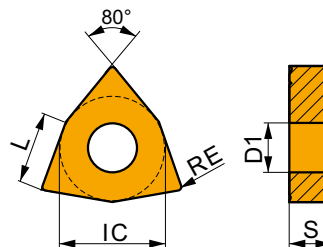

Idoneità e valori iniziali per velocità di taglio (Vc), avanzamento (f) e profondità di taglio (ap). Fare riferimento alla nostra App Machining Calculator per ulteriori calcoli.

Codice prodotto	RE	P			M			K			N			S			H		
		vc	f	ap	vc	f	ap	vc	f	ap	vc	f	ap	vc	f	ap	vc	f	ap
	(mm)	(m/min)	(mm/rev)	(mm)	(m/min)	(mm/rev)	(mm)	(m/min)	(mm/rev)	(mm)	(m/min)	(mm/rev)	(mm)	(m/min)	(mm/rev)	(mm)	(m/min)	(mm/rev)	(mm)

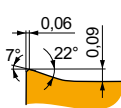
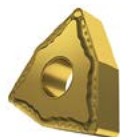

FF geometria altamente positiva per operazioni di super finitura, da taglio continuo a leggermente interrotto.

WNMG 060402E-FF	T8315	0.2	■	215	0.10	1.0	■	125	0.09	1.0	■	200	0.10	1.0	–	–	–	–	–	–	–	–
WNMG 060404E-FF	T8315	0.4	■	220	0.12	1.0	■	130	0.11	1.0	■	205	0.12	1.0	–	–	–	–	–	–	–	–



Idoneità e valori iniziali per velocità di taglio (Vc), avanzamento (f) e profondità di taglio (ap). Fare riferimento alla nostra App Machining Calculator per ulteriori calcoli.

Codice prodotto	RE (mm)	P			M			K			N			S			H		
		vc (m/min)	f (mm/rev)	ap (mm)	vc (m/min)	f (mm/rev)	ap (mm)	vc (m/min)	f (mm/rev)	ap (mm)	vc (m/min)	f (mm/rev)	ap (mm)	vc (m/min)	f (mm/rev)	ap (mm)	vc (m/min)	f (mm/rev)	ap (mm)

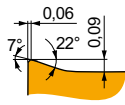
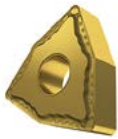

FF geometria altamente positiva per operazioni di super finitura, da taglio continuo a leggermente interrotto.

WNMG 080404E-FF	T7325	0.4	235	0.12	1.0	180	0.11	1.0	-	-	-	-	-	-	-	-	-	-
	T8315	0.4	220	0.12	1.0	130	0.11	1.0	205	0.12	1.0	-	-	-	-	-	-	-
WNMG 080408E-FF	T7325	0.8	265	0.15	1.0	205	0.14	1.0	-	-	-	-	-	-	-	-	-	-
	T8315	0.8	245	0.15	1.0	145	0.14	1.0	230	0.15	1.0	-	-	-	-	-	-	-

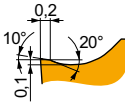
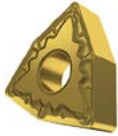

FM geometria positiva per operazioni da finitura fino a semi sgrassatura, da taglio continuo a leggermente interrotto.

WNMG 060404E-FM	T7325	0.4	195	0.20	1.4	150	0.18	1.4	-	-	-	-	-	-	60	0.16	1.1	-	-	-
	T8315	0.4	180	0.20	1.4	105	0.18	1.4	170	0.20	1.4	-	-	-	45	0.14	1.1	-	-	-
	T8330	0.4	175	0.20	1.4	105	0.18	1.4	165	0.20	1.4	-	-	-	40	0.14	1.1	-	-	-
	T8430	0.4	195	0.20	1.4	105	0.18	1.4	160	0.20	1.4	-	-	-	40	0.14	1.1	-	-	-
	T9315	0.4	265	0.20	1.4	-	-	-	250	0.20	1.4	-	-	-	-	-	-	-	-	-
	T9325	0.4	240	0.20	1.4	140	0.18	1.4	225	0.20	1.4	-	-	-	50	0.16	1.1	-	-	-
	TT310	0.4	275	0.20	1.4	165	0.18	1.4	-	-	-	-	-	-	-	-	-	-	-	
WNMG 060408E-FM	T7325	0.8	235	0.20	1.4	180	0.18	1.4	-	-	-	-	-	-	75	0.16	1.1	-	-	-
	T8330	0.8	205	0.20	1.4	120	0.18	1.4	190	0.20	1.4	-	-	-	50	0.14	1.1	-	-	-
	T8430	0.8	235	0.20	1.4	125	0.18	1.4	190	0.20	1.4	-	-	-	50	0.14	1.1	-	-	-
	T9315	0.8	315	0.20	1.4	-	-	-	295	0.20	1.4	-	-	-	-	-	-	-	-	-
	T9325	0.8	285	0.20	1.4	170	0.18	1.4	270	0.20	1.4	-	-	-	60	0.16	1.1	-	-	-
WNMG 060412E-FM	T9315	1.2	300	0.27	1.2	-	-	-	285	0.27	1.2	-	-	-	-	-	-	-	-	-
WNMG 06T304E-FM	T7325	0.4	195	0.20	1.4	150	0.18	1.4	-	-	-	-	-	-	60	0.16	1.1	-	-	-
	T8330	0.4	175	0.20	1.4	105	0.18	1.4	165	0.20	1.4	-	-	-	40	0.14	1.1	-	-	-
	T8430	0.4	195	0.20	1.4	105	0.18	1.4	160	0.20	1.4	-	-	-	40	0.14	1.1	-	-	-
	T9325	0.4	240	0.20	1.4	140	0.18	1.4	225	0.20	1.4	-	-	-	50	0.16	1.1	-	-	-
	T9315	0.4	270	0.20	1.2	-	-	-	255	0.20	1.2	-	-	-	-	-	-	-	-	-
WNMG 06T308E-FM	T8330	0.8	205	0.20	1.4	120	0.18	1.4	190	0.20	1.4	-	-	-	50	0.14	1.1	-	-	-
	T8430	0.8	235	0.20	1.4	125	0.18	1.4	190	0.20	1.4	-	-	-	50	0.14	1.1	-	-	-
	T9325	0.8	285	0.20	1.4	170	0.18	1.4	270	0.20	1.4	-	-	-	60	0.16	1.1	-	-	-
WNMG 080404E-FM	T7325	0.4	190	0.20	1.9	145	0.18	1.9	-	-	-	-	-	-	60	0.16	1.5	-	-	-
	T7335	0.4	180	0.20	1.9	140	0.18	1.9	-	-	-	-	-	-	55	0.16	1.5	-	-	-
	T8315	0.4	180	0.20	1.9	105	0.18	1.9	170	0.20	1.9	-	-	-	45	0.14	1.5	-	-	-
	T8330	0.4	165	0.20	1.9	95	0.18	1.9	155	0.20	1.9	-	-	-	40	0.14	1.5	-	-	-
	T8430	0.4	190	0.20	1.9	105	0.18	1.9	155	0.20	1.9	-	-	-	40	0.14	1.5	-	-	-
	T9310	0.4	285	0.20	1.9	-	-	-	270	0.20	1.9	-	-	-	-	-	-	-	-	-
	T9315	0.4	270	0.20	1.2	-	-	-	255	0.20	1.2	-	-	-	-	-	-	-	-	-
T9325	0.4	245	0.20	1.2	145	0.18	1.2	230	0.20	1.2	-	-	-	55	0.16	1.0	-	-	-	
WNMG 080408E-FM	T7325	0.8	225	0.20	1.9	175	0.18	1.9	-	-	-	-	-	-	70	0.16	1.5	-	-	-
	T7335	0.8	215	0.20	1.9	165	0.18	1.9	-	-	-	-	-	-	65	0.16	1.5	-	-	-
	T8315	0.8	210	0.20	1.9	125	0.18	1.9	195	0.20	1.9	-	-	-	50	0.16	1.5	-	-	-
	T8330	0.8	195	0.20	1.9	115	0.18	1.9	185	0.20	1.9	-	-	-	45	0.16	1.5	-	-	-
	T8430	0.8	225	0.20	1.9	120	0.18	1.9	185	0.20	1.9	-	-	-	45	0.16	1.5	-	-	-
	T9310	0.8	335	0.20	1.9	-	-	-	315	0.20	1.9	-	-	-	-	-	-	-	-	-
	T9315	0.8	310	0.20	1.9	-	-	-	290	0.20	1.9	-	-	-	-	-	-	-	-	-
T9325	0.8	280	0.20	1.9	165	0.18	1.9	265	0.20	1.9	-	-	-	60	0.16	1.5	-	-	-	
WNMG 080412E-FM	T7325	1.2	220	0.27	1.9	170	0.24	1.9	-	-	-	-	-	-	70	0.19	1.5	-	-	-
	T7335	1.2	205	0.27	1.9	155	0.24	1.9	-	-	-	-	-	-	65	0.19	1.5	-	-	-
	T8330	1.2	190	0.27	1.9	110	0.24	1.9	180	0.27	1.9	-	-	-	45	0.19	1.5	-	-	-
	T8430	1.2	210	0.27	1.9	115	0.24	1.9	175	0.27	1.9	-	-	-	45	0.19	1.5	-	-	-
	T9310	1.2	310	0.27	1.9	-	-	-	290	0.27	1.9	-	-	-	-	-	-	-	-	-
	T9315	1.2	285	0.27	1.9	-	-	-	270	0.27	1.9	-	-	-	-	-	-	-	-	-
	T9325	1.2	255	0.27	1.9	150	0.24	1.9	240	0.27	1.9	-	-	-	55	0.19	1.5	-	-	-



Idoneità e valori iniziali per velocità di taglio (Vc), avanzamento (f) e profondità di taglio (ap). Fare riferimento alla nostra App Machining Calculator per ulteriori calcoli.

Codice prodotto	RE  (mm)	P			M			K			N			S			H		
		vc (m/min)	f (mm/rev)	ap (mm)	vc (m/min)	f (mm/rev)	ap (mm)	vc (m/min)	f (mm/rev)	ap (mm)	vc (m/min)	f (mm/rev)	ap (mm)	vc (m/min)	f (mm/rev)	ap (mm)	vc (m/min)	f (mm/rev)	ap (mm)

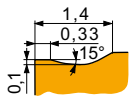

KR geometria per operazioni da semi sgrossatura fino a sgrossatura, da taglio continuo a interrotto.

WNMG 080408E-KR	T5305	0.8	255	0.35	3.5	-	-	-	240	0.35	3.5	-	-	-	-	-	50	0.15	1.0
	T5315	0.8	230	0.35	3.5	-	-	-	215	0.35	3.5	-	-	-	-	-	45	0.15	1.0
WNMG 080412E-KR	T5305	1.2	260	0.40	3.5	-	-	-	245	0.40	3.5	-	-	-	-	-	50	0.15	1.0
	T5315	1.2	235	0.40	3.5	-	-	-	220	0.40	3.5	-	-	-	-	-	45	0.15	1.0

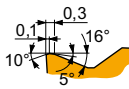

M geometria per operazioni da finitura fino a semi sgrossatura, da taglio continuo a interrotto.

WNMG 060404E-M	T5315	0.4	250	0.20	1.8	-	-	-	235	0.20	1.8	-	-	-	-	-	50	0.15	1.0
	T9315	0.4	240	0.20	1.8	-	-	-	225	0.20	1.8	-	-	-	-	-	45	0.15	1.0
	T9325	0.4	215	0.20	1.8	-	-	-	200	0.20	1.8	-	-	-	-	-	-	-	-
	T9335	0.4	180	0.20	1.8	-	-	-	-	-	-	-	-	-	-	-	-	-	-
WNMG 060408E-M	T5315	0.8	255	0.32	1.8	-	-	-	240	0.32	1.8	-	-	-	-	-	50	0.15	1.0
	T9310	0.8	250	0.32	1.8	-	-	-	235	0.32	1.8	-	-	-	-	-	50	0.15	1.0
	T9315	0.8	230	0.32	1.8	-	-	-	215	0.32	1.8	-	-	-	-	-	45	0.15	1.0
	T9325	0.8	205	0.32	1.8	-	-	-	190	0.32	1.8	-	-	-	-	-	-	-	-
	T9335	0.8	180	0.32	1.8	-	-	-	-	-	-	-	-	-	-	-	-	-	-
WNMG 080404E-M	T5315	0.4	260	0.20	1.2	-	-	-	245	0.20	1.2	-	-	-	-	-	50	0.15	1.0
	T9315	0.4	235	0.20	2.1	-	-	-	220	0.20	2.1	-	-	-	-	-	45	0.15	1.0
	T9325	0.4	210	0.20	2.1	-	-	-	195	0.20	2.1	-	-	-	-	-	-	-	-
	T9335	0.4	180	0.20	2.1	-	-	-	-	-	-	-	-	-	-	-	-	-	-
WNMG 080408E-M	T5305	0.8	280	0.32	2.1	-	-	-	265	0.32	2.1	-	-	-	-	-	55	0.15	1.0
	T5315	0.8	250	0.32	2.1	-	-	-	235	0.32	2.1	-	-	-	-	-	50	0.15	1.0
	T8330	0.8	155	0.32	2.1	-	-	-	145	0.32	2.1	-	-	-	-	-	30	0.15	1.0
	T8430	0.8	170	0.32	2.1	-	-	-	135	0.32	2.1	-	-	-	-	-	25	0.15	1.0
	T9310	0.8	245	0.32	2.1	-	-	-	230	0.32	2.1	-	-	-	-	-	45	0.15	1.0
	T9315	0.8	225	0.32	2.1	-	-	-	210	0.32	2.1	-	-	-	-	-	45	0.15	1.0
	T9325	0.8	200	0.32	2.1	-	-	-	190	0.32	2.1	-	-	-	-	-	-	-	-
	T9335	0.8	180	0.32	2.1	-	-	-	-	-	-	-	-	-	-	-	-	-	-
WNMG 080412E-M	T5305	1.2	275	0.40	2.1	-	-	-	260	0.40	2.1	-	-	-	-	-	55	0.15	1.0
	T5315	1.2	245	0.40	2.1	-	-	-	230	0.40	2.1	-	-	-	-	-	45	0.15	1.0
	T9310	1.2	235	0.40	2.1	-	-	-	220	0.40	2.1	-	-	-	-	-	45	0.15	1.0
	T9315	1.2	220	0.40	2.1	-	-	-	205	0.40	2.1	-	-	-	-	-	40	0.15	1.0
	T9325	1.2	195	0.40	2.1	-	-	-	185	0.40	2.1	-	-	-	-	-	-	-	-

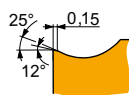

NF geometria con design altamente positivo per operazioni da finitura fino a medie lavorazioni, taglio continuo.

WNMG 060404E-NF	T6310	0.4	190	0.17	0.8	135	0.15	0.8	150	0.17	0.8	570	0.20	0.8	55	0.12	0.6	-	-	-
	T7325	0.4	215	0.18	0.8	165	0.16	0.8	-	-	-	-	-	-	65	0.16	0.6	-	-	-
	T7335	0.4	210	0.18	0.8	160	0.16	0.8	-	-	-	-	-	-	65	0.16	0.6	-	-	-
	T8315	0.4	200	0.17	0.8	120	0.15	0.8	190	0.17	0.8	600	0.20	0.8	50	0.12	0.6	-	-	-
	T8330	0.4	190	0.17	0.8	110	0.15	0.8	180	0.17	0.8	570	0.20	0.8	45	0.12	0.6	-	-	-
	T8430	0.4	225	0.17	0.8	120	0.15	0.8	185	0.17	0.8	615	0.20	0.8	45	0.12	0.6	-	-	-
	T9315	0.4	305	0.17	0.8	-	-	-	285	0.17	0.8	-	-	-	-	-	-	-	-	-
	T9325	0.4	265	0.18	0.8	155	0.16	0.8	250	0.18	0.8	-	-	-	55	0.16	0.6	-	-	-
WNMG 060408E-NF	T6310	0.8	215	0.19	1.0	150	0.17	1.0	170	0.19	1.0	645	0.23	1.0	60	0.15	0.8	-	-	-
	T7325	0.8	245	0.19	1.0	190	0.17	1.0	-	-	-	-	-	75	0.15	0.8	-	-	-	
	T8330	0.8	215	0.19	1.0	125	0.17	1.0	200	0.19	1.0	645	0.23	1.0	50	0.15	0.8	-	-	-
	T8430	0.8	245	0.19	1.0	135	0.17	1.0	200	0.19	1.0	675	0.23	1.0	50	0.15	0.8	-	-	-
	T9315	0.8	335	0.19	1.0	-	-	-	315	0.19	1.0	-	-	-	-	-	-	-	-	-
	T9325	0.8	300	0.19	1.0	180	0.17	1.0	285	0.19	1.0	-	-	-	65	0.15	0.8	-	-	-



Idoneità e valori iniziali per velocità di taglio (Vc), avanzamento (f) e profondità di taglio (ap). Fare riferimento alla nostra App Machining Calculator per ulteriori calcoli.

Codice prodotto	RE (mm)	P			M			K			N			S			H		
		vc (m/min)	f (mm/rev)	ap (mm)	vc (m/min)	f (mm/rev)	ap (mm)	vc (m/min)	f (mm/rev)	ap (mm)	vc (m/min)	f (mm/rev)	ap (mm)	vc (m/min)	f (mm/rev)	ap (mm)	vc (m/min)	f (mm/rev)	ap (mm)

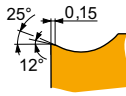

NF geometria con design altamente positivo per operazioni da finitura fino a medie lavorazioni, taglio continuo.

WNMG 080404E-NF	HF7	0.4	–	–	–	95	0.15	1.7	155	0.17	1.7	495	0.20	1.7	–	–	–	–	–	–
	T6310	0.4	180	0.17	1.7	125	0.15	1.7	145	0.17	1.7	540	0.20	1.7	50	0.14	1.4	–	–	–
	T7325	0.4	200	0.18	1.7	155	0.16	1.7	–	–	–	–	–	–	65	0.16	1.4	–	–	–
	T7335	0.4	195	0.18	1.7	150	0.16	1.7	–	–	–	–	–	–	60	0.16	1.4	–	–	–
	T8315	0.4	185	0.17	1.7	110	0.15	1.7	175	0.17	1.7	555	0.20	1.7	45	0.14	1.4	–	–	–
	T8330	0.4	180	0.17	1.7	105	0.15	1.7	170	0.17	1.7	540	0.20	1.7	45	0.14	1.4	–	–	–
	T8430	0.4	200	0.17	1.7	110	0.15	1.7	165	0.17	1.7	555	0.20	1.7	40	0.14	1.4	–	–	–
	T9315	0.4	285	0.17	1.7	–	–	–	270	0.17	1.7	–	–	–	–	–	–	–	–	–
	T9325	0.4	250	0.18	1.7	150	0.16	1.7	235	0.18	1.7	–	–	–	55	0.16	1.4	–	–	–
	WNMG 080408E-NF	HF7	0.8	–	–	–	110	0.17	1.7	180	0.19	1.7	570	0.23	1.7	–	–	–	–	–
T6310		0.8	200	0.19	1.7	140	0.17	1.7	160	0.19	1.7	600	0.23	1.7	60	0.15	1.4	–	–	–
T7325		0.8	235	0.19	1.7	180	0.17	1.7	–	–	–	–	–	–	75	0.15	1.4	–	–	–
T7335		0.8	225	0.19	1.7	175	0.17	1.7	–	–	–	–	–	–	70	0.15	1.4	–	–	–
T8315		0.8	215	0.19	1.7	125	0.17	1.7	200	0.19	1.7	645	0.23	1.7	50	0.15	1.4	–	–	–
T8330		0.8	200	0.19	1.7	120	0.17	1.7	190	0.19	1.7	600	0.23	1.7	50	0.15	1.4	–	–	–
T8430		0.8	235	0.19	1.7	125	0.17	1.7	190	0.19	1.7	645	0.23	1.7	50	0.15	1.4	–	–	–
T9315		0.8	320	0.19	1.7	–	–	–	300	0.19	1.7	–	–	–	–	–	–	–	–	–
WNMG 080412E-NF	T6310	1.2	185	0.30	2.1	130	0.27	2.1	145	0.30	2.1	555	0.36	2.1	55	0.21	1.7	–	–	–
	T7325	1.2	205	0.30	2.1	155	0.27	2.1	–	–	–	–	–	–	65	0.21	1.7	–	–	–
	T8430	1.2	200	0.30	2.1	110	0.27	2.1	165	0.30	2.1	555	0.36	2.1	40	0.21	1.7	–	–	–
	T9315	1.2	275	0.30	2.1	–	–	–	260	0.30	2.1	–	–	–	–	–	–	–	–	–
	T9325	1.2	245	0.30	2.1	145	0.27	2.1	230	0.30	2.1	–	–	–	55	0.21	1.7	–	–	–

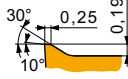

NM geometria con design altamente positivo per operazioni di finitura, media sgrassatura, taglio continuo.

WNMG 060404E-NM	T7325	0.4	200	0.20	1.8	155	0.18	1.8	–	–	–	–	–	–	65	0.16	1.4	–	–	–
	T7335	0.4	195	0.20	1.8	150	0.18	1.8	–	–	–	–	–	–	60	0.16	1.4	–	–	–
	T8315	0.4	185	0.20	1.8	110	0.18	1.8	–	–	–	555	0.24	1.8	45	0.16	1.4	–	–	–
	T8330	0.4	175	0.20	1.8	105	0.18	1.8	–	–	–	525	0.24	1.8	40	0.16	1.4	–	–	–
	T8430	0.4	185	0.25	1.8	100	0.23	1.8	–	–	–	510	0.30	1.8	40	0.20	1.4	–	–	–
	T9325	0.4	245	0.20	1.8	145	0.18	1.8	–	–	–	–	–	–	55	0.16	1.4	–	–	–
WNMG 060408E-NM	T7325	0.8	220	0.25	1.8	170	0.23	1.8	–	–	–	–	–	–	70	0.20	1.4	–	–	–
	T7335	0.8	215	0.25	1.8	165	0.23	1.8	–	–	–	–	–	–	65	0.20	1.4	–	–	–
	T8315	0.8	205	0.25	1.8	120	0.23	1.8	–	–	–	615	0.30	1.8	50	0.20	1.4	–	–	–
	T8330	0.8	195	0.25	1.8	115	0.23	1.8	–	–	–	585	0.30	1.8	45	0.20	1.4	–	–	–
	T8430	0.8	220	0.25	1.8	120	0.23	1.8	–	–	–	600	0.30	1.8	45	0.20	1.4	–	–	–
	T9315	0.8	290	0.25	1.8	–	–	–	–	–	–	–	–	–	–	–	–	–	–	–
	T9325	0.8	265	0.25	1.8	155	0.23	1.8	–	–	–	–	–	–	55	0.20	1.4	–	–	–
WNMG 060412E-NM	T7325	1.2	220	0.30	1.8	170	0.27	1.8	–	–	–	–	–	–	70	0.24	1.4	–	–	–
	T7335	1.2	220	0.30	1.2	170	0.27	1.2	–	–	–	–	–	–	70	0.24	1.0	–	–	–
	T9315	1.2	285	0.30	1.8	–	–	–	–	–	–	–	–	–	–	–	–	–	–	–
	T9325	1.2	255	0.30	1.8	150	0.27	1.8	–	–	–	–	–	–	55	0.24	1.4	–	–	–
WNMG 080404E-NM	T7325	0.4	195	0.20	2.1	150	0.18	2.1	–	–	–	–	–	–	60	0.16	1.7	–	–	–
	T7335	0.4	190	0.20	2.1	145	0.18	2.1	–	–	–	–	–	–	60	0.16	1.7	–	–	–
	T8315	0.4	180	0.20	2.1	105	0.18	2.1	–	–	–	540	0.24	2.1	45	0.16	1.7	–	–	–
	T8330	0.4	170	0.20	2.1	100	0.18	2.1	–	–	–	510	0.24	2.1	40	0.16	1.7	–	–	–
	T8430	0.4	180	0.25	2.1	95	0.23	2.1	–	–	–	495	0.30	2.1	35	0.20	1.7	–	–	–
	T9315	0.4	270	0.20	2.1	–	–	–	–	–	–	–	–	–	–	–	–	–	–	–
	T9325	0.4	240	0.20	2.1	140	0.18	2.1	–	–	–	–	–	–	50	0.16	1.7	–	–	–



Idoneità e valori iniziali per velocità di taglio (Vc), avanzamento (f) e profondità di taglio (ap). Fare riferimento alla nostra App Machining Calculator per ulteriori calcoli.

Codice prodotto	RE (mm)	P			M			K			N			S			H		
		vc (m/min)	f (mm/rev)	ap (mm)	vc (m/min)	f (mm/rev)	ap (mm)	vc (m/min)	f (mm/rev)	ap (mm)	vc (m/min)	f (mm/rev)	ap (mm)	vc (m/min)	f (mm/rev)	ap (mm)	vc (m/min)	f (mm/rev)	ap (mm)

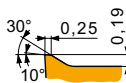

NM geometria con design altamente positivo per operazioni di finitura, media sgrassatura, taglio continuo.

WNMG 080408E-NM	T7325	0.8	215	0.25	2.1	165	0.23	2.1	-	-	-	-	-	-	65	0.20	1.7	-	-	-
	T7335	0.8	210	0.25	2.1	160	0.23	2.1	-	-	-	-	-	-	65	0.20	1.7	-	-	-
	T8315	0.8	205	0.25	2.1	120	0.23	2.1	-	-	-	615	0.30	2.1	50	0.20	1.7	-	-	-
	T8330	0.8	195	0.25	2.1	115	0.23	2.1	-	-	-	585	0.30	2.1	45	0.20	1.7	-	-	-
	T8430	0.8	210	0.25	2.1	115	0.23	2.1	-	-	-	585	0.30	2.1	45	0.20	1.7	-	-	-
	T9315	0.8	290	0.25	2.1	-	-	-	-	-	-	-	-	-	-	-	-	-	-	-
WNMG 080412E-NM	T7325	1.2	215	0.30	2.1	165	0.27	2.1	-	-	-	-	-	-	65	0.24	1.7	-	-	-
	T7335	1.2	210	0.30	2.1	160	0.27	2.1	-	-	-	-	-	-	65	0.24	1.7	-	-	-
	T8315	1.2	205	0.30	2.1	120	0.27	2.1	-	-	-	615	0.36	2.1	50	0.24	1.7	-	-	-
	T9325	1.2	255	0.30	2.1	150	0.27	2.1	-	-	-	-	-	-	55	0.24	1.7	-	-	-

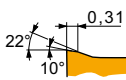

NMR geometria con design positivo per operazioni da media fino a sgrassatura, taglio continuo.

WNMG 060404E-NMR	T6310	0.4	145	0.25	1.6	100	0.23	1.6	-	-	-	-	-	-	40	0.20	1.3	-	-	-
	T7325	0.4	160	0.25	1.6	120	0.23	1.6	-	-	-	-	-	-	50	0.20	1.3	-	-	-
	T8430	0.4	145	0.31	1.6	80	0.28	1.6	-	-	-	-	-	-	30	0.25	1.3	-	-	-
	T9325	0.4	200	0.25	1.6	120	0.23	1.6	-	-	-	-	-	-	45	0.20	1.3	-	-	-
WNMG 060408E-NMR	T6310	0.8	155	0.35	1.6	110	0.32	1.6	-	-	-	-	-	-	45	0.25	1.3	-	-	-
	T7325	0.8	175	0.35	1.6	135	0.32	1.6	-	-	-	-	-	-	55	0.25	1.3	-	-	-
	T7335	0.8	170	0.35	1.6	130	0.32	1.6	-	-	-	-	-	-	55	0.25	1.3	-	-	-
	T9315	0.8	225	0.35	1.6	-	-	-	-	-	-	-	-	-	-	-	-	-	-	-
	T9325	0.8	200	0.35	1.6	120	0.32	1.6	-	-	-	-	-	-	45	0.25	1.3	-	-	-
WNMG 080404E-NMR	T6310	0.4	140	0.25	2.7	100	0.23	2.7	-	-	-	-	-	-	40	0.20	2.2	-	-	-
	T7325	0.4	155	0.25	2.7	120	0.23	2.7	-	-	-	-	-	-	50	0.20	2.2	-	-	-
	T7335	0.4	150	0.25	2.7	115	0.23	2.7	-	-	-	-	-	-	45	0.20	2.2	-	-	-
	T8330	0.4	140	0.25	2.7	80	0.23	2.7	-	-	-	-	-	-	35	0.20	2.2	-	-	-
	T8430	0.4	140	0.31	2.7	75	0.28	2.7	-	-	-	-	-	-	30	0.25	2.2	-	-	-
	T9315	0.4	205	0.25	2.7	-	-	-	-	-	-	-	-	-	-	-	-	-	-	-
	T9325	0.4	185	0.25	2.7	110	0.23	2.7	-	-	-	-	-	-	40	0.20	2.2	-	-	-
	T9325	0.4	185	0.25	2.7	110	0.23	2.7	-	-	-	-	-	-	40	0.20	2.2	-	-	-
WNMG 080408E-NMR	T6310	0.8	150	0.35	2.7	105	0.32	2.7	-	-	-	-	-	-	45	0.25	2.2	-	-	-
	T7325	0.8	170	0.35	2.7	130	0.32	2.7	-	-	-	-	-	-	55	0.25	2.2	-	-	-
	T7335	0.8	160	0.35	2.7	120	0.32	2.7	-	-	-	-	-	-	50	0.25	2.2	-	-	-
	T8330	0.8	150	0.35	2.7	90	0.32	2.7	-	-	-	-	-	-	35	0.25	2.2	-	-	-
	T8430	0.8	155	0.35	2.7	85	0.32	2.7	-	-	-	-	-	-	30	0.25	2.2	-	-	-
	T9315	0.8	210	0.35	2.7	-	-	-	-	-	-	-	-	-	-	-	-	-	-	-
	T9325	0.8	190	0.35	2.7	110	0.32	2.7	-	-	-	-	-	-	40	0.25	2.2	-	-	-
	T9325	0.8	190	0.35	2.7	110	0.32	2.7	-	-	-	-	-	-	40	0.25	2.2	-	-	-
WNMG 080412E-NMR	T6310	1.2	150	0.40	2.7	105	0.36	2.7	-	-	-	-	-	-	45	0.28	2.2	-	-	-
	T7325	1.2	170	0.40	2.7	130	0.36	2.7	-	-	-	-	-	-	55	0.28	2.2	-	-	-
	T7335	1.2	160	0.40	2.7	120	0.36	2.7	-	-	-	-	-	-	50	0.28	2.2	-	-	-
	T8330	1.2	150	0.40	2.7	90	0.36	2.7	-	-	-	-	-	-	35	0.28	2.2	-	-	-
	T8430	1.2	155	0.40	2.7	85	0.36	2.7	-	-	-	-	-	-	30	0.28	2.2	-	-	-
	T9315	1.2	215	0.40	2.7	-	-	-	-	-	-	-	-	-	-	-	-	-	-	-
T9325	1.2	190	0.40	2.7	110	0.36	2.7	-	-	-	-	-	-	40	0.28	2.2	-	-	-	

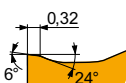

NRM geometria con design positivo per operazioni da semi sgrassatura fino a sgrassatura, da taglio continuo a moderatamente interrotto.

WNMG 080404-NRM	T7325	0.4	155	0.25	2.7	120	0.23	2.7	-	-	-	-	-	-	50	0.18	2.2	-	-	-
	T7335	0.4	150	0.25	2.7	115	0.23	2.7	-	-	-	-	-	-	45	0.18	2.2	-	-	-
	T9315	0.4	205	0.25	2.7	-	-	-	-	-	-	-	-	-	-	-	-	-	-	-
WNMG 080408-NRM	T7325	0.8	170	0.35	2.7	130	0.32	2.7	-	-	-	-	-	-	55	0.28	2.2	-	-	-
	T7335	0.8	160	0.35	2.7	120	0.32	2.7	-	-	-	-	-	-	50	0.28	2.2	-	-	-
	T9315	0.8	210	0.35	2.7	-	-	-	-	-	-	-	-	-	-	-	-	-	-	-



Idoneità e valori iniziali per velocità di taglio (Vc), avanzamento (f) e profondità di taglio (ap). Fare riferimento alla nostra App Machining Calculator per ulteriori calcoli.

Codice prodotto	RE  (mm)	P			M			K			N			S			H		
		vc (m/min)	f (mm/rev)	ap (mm)	vc (m/min)	f (mm/rev)	ap (mm)	vc (m/min)	f (mm/rev)	ap (mm)	vc (m/min)	f (mm/rev)	ap (mm)	vc (m/min)	f (mm/rev)	ap (mm)	vc (m/min)	f (mm/rev)	ap (mm)

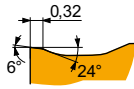
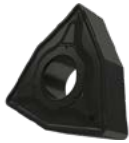

NRM geometria con design positivo per operazioni da semi sgrossatura fino a sgrossatura, da taglio continuo a moderatamente interrotto.

WNMG 080412-NRM	T7325	1.2	170	0.40	2.7	130	0.36	2.7	-	-	-	-	-	-	55	0.28	2.2	-	-	-
	T7335	1.2	160	0.40	2.7	120	0.36	2.7	-	-	-	-	-	-	50	0.28	2.2	-	-	-
	T9315	1.2	215	0.40	2.7	-	-	-	-	-	-	-	-	-	-	-	-	-	-	-

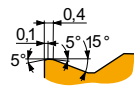

R geometria per operazioni da semi sgrossatura fino a sgrossatura, da taglio continuo a interrotto.

WNMG 080408E-R	T5305	0.8	245	0.40	3.5	-	-	-	230	0.40	3.5	-	-	-	-	-	-	45	0.15	1.0
	T5315	0.8	220	0.40	3.5	-	-	-	205	0.40	3.5	-	-	-	-	-	-	40	0.15	1.0
	T9310	0.8	210	0.40	3.5	-	-	-	195	0.40	3.5	-	-	-	-	-	-	40	0.15	1.0
	T9315	0.8	195	0.40	3.5	-	-	-	185	0.40	3.5	-	-	-	-	-	-	35	0.15	1.0
	T9325	0.8	175	0.40	3.5	-	-	-	165	0.40	3.5	-	-	-	-	-	-	-	-	-
	T9335	0.8	155	0.40	3.5	-	-	-	-	-	-	-	-	-	-	-	-	-	-	-
WNMG 080412E-R	T5305	1.2	250	0.45	3.5	-	-	-	235	0.45	3.5	-	-	-	-	-	-	50	0.15	1.0
	T5315	1.2	225	0.45	3.5	-	-	-	210	0.45	3.5	-	-	-	-	-	-	45	0.15	1.0
	T9310	1.2	215	0.45	3.5	-	-	-	200	0.45	3.5	-	-	-	-	-	-	40	0.15	1.0
	T9315	1.2	200	0.45	3.5	-	-	-	190	0.45	3.5	-	-	-	-	-	-	40	0.15	1.0
	T9325	1.2	180	0.45	3.5	-	-	-	170	0.45	3.5	-	-	-	-	-	-	-	-	-
	T9335	1.2	155	0.45	3.5	-	-	-	-	-	-	-	-	-	-	-	-	-	-	-

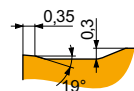
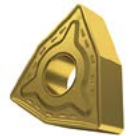

RM geometria per operazioni da semi sgrossatura fino a sgrossatura, da taglio continuo a interrotto.

WNMG 060412E-RM	T9310	1.2	245	0.45	3.0	-	-	-	230	0.45	3.0	-	-	-	-	-	-	-	-	-
	T9315	1.2	230	0.45	3.0	-	-	-	215	0.45	3.0	-	-	-	-	-	-	-	-	-
	T9325	1.2	230	0.45	1.2	135	0.41	1.2	215	0.45	1.2	-	-	-	-	-	-	-	-	-
WNMG 080408E-RM	T5305	0.8	275	0.40	4.0	-	-	-	260	0.40	4.0	-	-	-	-	-	-	-	-	-
	T5315	0.8	250	0.40	4.0	-	-	-	235	0.40	4.0	-	-	-	-	-	-	-	-	-
	T7325	0.8	180	0.40	4.0	140	0.36	4.0	-	-	-	-	-	-	-	-	-	-	-	
	T7335	0.8	165	0.40	4.0	125	0.36	4.0	-	-	-	-	-	-	-	-	-	-	-	
	T8315	0.8	165	0.40	4.0	95	0.36	4.0	155	0.40	4.0	-	-	-	-	-	-	-	-	
	T8330	0.8	155	0.40	4.0	90	0.36	4.0	145	0.40	4.0	-	-	-	-	-	-	-	-	
	T8430	0.8	165	0.40	4.0	90	0.36	4.0	135	0.40	4.0	-	-	-	-	-	-	-	-	
	T9310	0.8	240	0.40	4.0	-	-	-	225	0.40	4.0	-	-	-	-	-	-	-	-	-
	T9315	0.8	220	0.40	4.0	-	-	-	205	0.40	4.0	-	-	-	-	-	-	-	-	-
	T9325	0.8	200	0.40	4.0	120	0.36	4.0	190	0.40	4.0	-	-	-	-	-	-	-	-	
	T9335	0.8	170	0.40	4.0	100	0.36	4.0	-	-	-	-	-	-	-	-	-	-	-	
	WNMG 080412E-RM	T5305	1.2	280	0.45	4.0	-	-	-	265	0.45	4.0	-	-	-	-	-	-	-	-
T5315		1.2	250	0.45	4.0	-	-	-	235	0.45	4.0	-	-	-	-	-	-	-	-	
T7325		1.2	180	0.45	4.0	140	0.41	4.0	-	-	-	-	-	-	-	-	-	-		
T7335		1.2	170	0.45	4.0	130	0.41	4.0	-	-	-	-	-	-	-	-	-	-		
T8315		1.2	170	0.45	4.0	100	0.41	4.0	160	0.45	4.0	-	-	-	-	-	-	-		
T9310		1.2	240	0.45	4.0	-	-	-	225	0.45	4.0	-	-	-	-	-	-	-	-	
T9315		1.2	220	0.45	4.0	-	-	-	205	0.45	4.0	-	-	-	-	-	-	-	-	
T9325		1.2	200	0.45	4.0	120	0.41	4.0	190	0.45	4.0	-	-	-	-	-	-	-		
T9335		1.2	175	0.45	4.0	105	0.41	4.0	-	-	-	-	-	-	-	-	-	-		
WNMG 080416E-RM	T5305	1.6	280	0.50	4.0	-	-	-	265	0.50	4.0	-	-	-	-	-	-	-	-	
	T5315	1.6	255	0.50	4.0	-	-	-	240	0.50	4.0	-	-	-	-	-	-	-	-	
	T7335	1.6	175	0.50	4.0	135	0.45	4.0	-	-	-	-	-	-	-	-	-	-		
	T8430	1.6	170	0.50	4.0	90	0.45	4.0	135	0.50	4.0	-	-	-	-	-	-	-		
	T9310	1.6	240	0.50	4.0	-	-	-	225	0.50	4.0	-	-	-	-	-	-	-		
	T9315	1.6	220	0.50	4.0	-	-	-	205	0.50	4.0	-	-	-	-	-	-	-		
	T9325	1.6	205	0.50	4.0	120	0.45	4.0	190	0.50	4.0	-	-	-	-	-	-	-		

CN	DN	KN	LN	RN	SN	TN	VN	WN
----	----	----	----	----	----	----	----	----



Idoneità e valori iniziali per velocità di taglio (Vc), avanzamento (f) e profondità di taglio (ap). Fare riferimento alla nostra App Machining Calculator per ulteriori calcoli.

Codice prodotto	RE (mm)	P			M			K			N			S			H		
		vc (m/min)	f (mm/rev)	ap (mm)	vc (m/min)	f (mm/rev)	ap (mm)	vc (m/min)	f (mm/rev)	ap (mm)	vc (m/min)	f (mm/rev)	ap (mm)	vc (m/min)	f (mm/rev)	ap (mm)	vc (m/min)	f (mm/rev)	ap (mm)

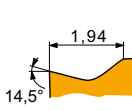

SF geometria con design positivo per operazioni di finitura su pareti sottili, taglio continuo.

WNMG 060404E-SF	H07	0.4	–	–	–	90	0.14	1.0	145	0.15	1.0	470	0.18	1.0	45	0.12	0.8	–	–	–	
	T6310	0.4	180	0.15	1.0	125	0.14	1.0	145	0.15	1.0	540	0.18	1.0	50	0.12	0.8	35	0.15	1.0	
	T7325	0.4	205	0.17	1.0	155	0.15	1.0	–	–	–	–	–	–	65	0.15	0.8	–	–	–	
	T7335	0.4	200	0.17	1.0	155	0.15	1.0	–	–	–	–	–	–	65	0.15	0.8	–	–	–	
	T8315	0.4	195	0.15	1.0	115	0.14	1.0	185	0.15	1.0	585	0.18	1.0	45	0.12	0.8	35	0.15	1.0	
	T8330	0.4	180	0.15	1.0	105	0.14	1.0	170	0.15	1.0	540	0.18	1.0	45	0.12	0.8	35	0.15	1.0	
	T8430	0.4	220	0.15	1.0	120	0.14	1.0	180	0.15	1.0	600	0.18	1.0	45	0.12	0.8	35	0.15	1.0	
	T9325	0.4	255	0.17	1.0	150	0.15	1.0	240	0.17	1.0	–	–	–	55	0.15	0.8	–	–	–	
	WNMG 060408E-SF	H07	0.8	–	–	–	95	0.18	1.0	155	0.20	1.0	495	0.24	1.0	50	0.14	0.8	–	–	–
		T6310	0.8	200	0.20	1.0	140	0.18	1.0	160	0.20	1.0	600	0.24	1.0	60	0.14	0.8	40	0.15	1.0
T7335		0.8	220	0.20	1.0	170	0.18	1.0	–	–	–	–	–	70	0.16	0.8	–	–	–		
T8315		0.8	210	0.20	1.0	125	0.18	1.0	195	0.20	1.0	630	0.24	1.0	50	0.14	0.8	40	0.15	1.0	
T8330		0.8	200	0.20	1.0	120	0.18	1.0	190	0.20	1.0	600	0.24	1.0	50	0.14	0.8	40	0.15	1.0	
T8430		0.8	230	0.20	1.0	125	0.18	1.0	185	0.20	1.0	630	0.24	1.0	45	0.14	0.8	35	0.15	1.0	
T9315		0.8	315	0.20	1.0	–	–	–	295	0.20	1.0	–	–	–	–	–	–	60	0.15	1.0	
T9325		0.8	280	0.20	1.0	165	0.18	1.0	265	0.20	1.0	–	–	–	60	0.16	0.8	–	–	–	
WNMG 080404E-SF	H07	0.4	–	–	–	90	0.14	1.0	145	0.15	1.0	470	0.18	1.0	45	0.12	0.8	–	–	–	
	T6310	0.4	180	0.15	1.0	125	0.14	1.0	145	0.15	1.0	540	0.18	1.0	50	0.12	0.8	35	0.15	1.0	
	T7325	0.4	205	0.17	1.0	155	0.15	1.0	–	–	–	–	–	65	0.15	0.8	–	–	–		
	T7335	0.4	200	0.17	1.0	155	0.15	1.0	–	–	–	–	–	65	0.15	0.8	–	–	–		
	T8315	0.4	195	0.15	1.0	115	0.14	1.0	185	0.15	1.0	585	0.18	1.0	45	0.12	0.8	35	0.15	1.0	
	T8330	0.4	180	0.15	1.0	105	0.14	1.0	170	0.15	1.0	540	0.18	1.0	45	0.12	0.8	35	0.15	1.0	
	T8430	0.4	220	0.15	1.0	120	0.14	1.0	180	0.15	1.0	600	0.18	1.0	45	0.12	0.8	35	0.15	1.0	
	T9315	0.4	300	0.15	1.0	–	–	–	285	0.15	1.0	–	–	–	–	–	–	60	0.15	1.0	
	T9325	0.4	255	0.17	1.0	150	0.15	1.0	240	0.17	1.0	–	–	–	55	0.15	0.8	–	–	–	
	WNMG 080408E-SF	H07	0.8	–	–	–	95	0.18	1.0	155	0.20	1.0	495	0.24	1.0	50	0.14	0.8	–	–	–
T6310		0.8	200	0.20	1.0	140	0.18	1.0	160	0.20	1.0	600	0.24	1.0	60	0.14	0.8	40	0.15	1.0	
T7325		0.8	230	0.20	1.0	175	0.18	1.0	–	–	–	–	–	70	0.16	0.8	–	–	–		
T7335		0.8	220	0.20	1.0	170	0.18	1.0	–	–	–	–	–	70	0.16	0.8	–	–	–		
T8315		0.8	210	0.20	1.0	125	0.18	1.0	195	0.20	1.0	630	0.24	1.0	50	0.14	0.8	40	0.15	1.0	
T8330		0.8	200	0.20	1.0	120	0.18	1.0	190	0.20	1.0	600	0.24	1.0	50	0.14	0.8	40	0.15	1.0	
T8430		0.8	230	0.20	1.0	125	0.18	1.0	185	0.20	1.0	630	0.24	1.0	45	0.14	0.8	35	0.15	1.0	
T9315		0.8	315	0.20	1.0	–	–	–	295	0.20	1.0	–	–	–	–	–	–	60	0.15	1.0	
T9325		0.8	280	0.20	1.0	165	0.18	1.0	265	0.20	1.0	–	–	–	60	0.16	0.8	–	–	–	
WNMG 080412E-SF		T7325	1.2	220	0.25	1.5	170	0.23	1.5	–	–	–	–	–	–	70	0.18	1.2	–	–	–

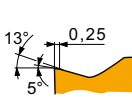

SM geometria con design positivo per medie lavorazioni, da taglio continuo a interrotto.

WNMG 060404E-SM	T7325	0.4	180	0.22	1.7	140	0.20	1.7	–	–	–	–	–	–	55	0.20	1.4	–	–	–
	T7335	0.4	175	0.22	1.7	135	0.20	1.7	–	–	–	–	–	–	55	0.20	1.4	–	–	–
	T8330	0.4	155	0.22	1.7	90	0.20	1.7	145	0.22	1.7	465	0.26	1.7	35	0.20	1.4	30	0.15	1.0
	T8430	0.4	175	0.22	1.7	95	0.20	1.7	140	0.22	1.7	480	0.26	1.7	35	0.20	1.4	30	0.15	1.0
	T9315	0.4	250	0.20	1.7	–	–	–	235	0.20	1.7	–	–	–	–	–	–	50	0.15	1.0
	T9325	0.4	215	0.22	1.7	125	0.20	1.7	200	0.22	1.7	–	–	–	45	0.20	1.4	–	–	–
WNMG 060408E-SM	T6310	0.8	175	0.25	1.7	125	0.23	1.7	140	0.25	1.7	525	0.30	1.7	50	0.20	1.4	35	0.15	1.0
	T7325	0.8	200	0.25	1.7	155	0.23	1.7	–	–	–	–	–	65	0.20	1.4	–	–	–	
	T7335	0.8	195	0.25	1.7	150	0.23	1.7	–	–	–	–	–	60	0.20	1.4	–	–	–	
	T8330	0.8	175	0.25	1.7	105	0.23	1.7	165	0.25	1.7	525	0.30	1.7	40	0.20	1.4	35	0.15	1.0
	T8430	0.8	195	0.25	1.7	105	0.23	1.7	160	0.25	1.7	540	0.30	1.7	40	0.20	1.4	30	0.15	1.0
	T9325	0.8	240	0.25	1.7	140	0.23	1.7	225	0.25	1.7	–	–	–	50	0.20	1.4	–	–	–
WNMG 060412E-SM	T7325	1.2	200	0.30	1.7	155	0.27	1.7	–	–	–	–	–	65	0.24	1.4	–	–	–	
	T8330	1.2	180	0.30	1.7	105	0.27	1.7	170	0.30	1.7	540	0.36	1.7	45	0.24	1.4	35	0.15	1.0
	T8430	1.2	195	0.30	1.7	105	0.27	1.7	160	0.30	1.7	540	0.36	1.7	40	0.24	1.4	30	0.15	1.0
	T9325	1.2	240	0.30	1.7	140	0.27	1.7	225	0.30	1.7	–	–	–	50	0.24	1.4	–	–	–



Idoneità e valori iniziali per velocità di taglio (Vc), avanzamento (f) e profondità di taglio (ap). Fare riferimento alla nostra App Machining Calculator per ulteriori calcoli.

Codice prodotto	RE (mm)	P			M			K			N			S			H		
		vc (m/min)	f (mm/rev)	ap (mm)	vc (m/min)	f (mm/rev)	ap (mm)	vc (m/min)	f (mm/rev)	ap (mm)	vc (m/min)	f (mm/rev)	ap (mm)	vc (m/min)	f (mm/rev)	ap (mm)	vc (m/min)	f (mm/rev)	ap (mm)

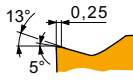

SM geometria con design positivo per medie lavorazioni, da taglio continuo a interrotto.

WNMG 080404E-SM	T6310	0.4	155	0.22	2.0	110	0.20	2.0	125	0.22	2.0	465	0.26	2.0	45	0.20	1.6	30	0.15	1.0	
	T7325	0.4	175	0.22	2.0	135	0.20	2.0	-	-	-	-	-	-	55	0.20	1.6	-	-	-	
	T7335	0.4	170	0.22	2.0	130	0.20	2.0	-	-	-	-	-	-	55	0.20	1.6	-	-	-	
	T8330	0.4	155	0.22	2.0	90	0.20	2.0	145	0.22	2.0	465	0.26	2.0	35	0.20	1.6	30	0.15	1.0	
	T8430	0.4	170	0.22	2.0	90	0.20	2.0	135	0.22	2.0	465	0.26	2.0	35	0.20	1.6	25	0.15	1.0	
	T9315	0.4	245	0.20	2.0	-	-	-	230	0.20	2.0	-	-	-	-	-	-	-	45	0.15	1.0
	T9325	0.4	210	0.22	2.0	125	0.20	2.0	195	0.22	2.0	-	-	-	45	0.20	1.6	-	-	-	
WNMG 080408E-SM	T6310	0.8	175	0.25	2.0	125	0.23	2.0	140	0.25	2.0	525	0.30	2.0	50	0.20	1.6	35	0.15	1.0	
	T7325	0.8	200	0.25	2.0	155	0.23	2.0	-	-	-	-	-	65	0.20	1.6	-	-	-		
	T7335	0.8	190	0.25	2.0	145	0.23	2.0	-	-	-	-	-	60	0.20	1.6	-	-	-		
	T8330	0.8	175	0.25	2.0	105	0.23	2.0	165	0.25	2.0	525	0.30	2.0	40	0.20	1.6	35	0.15	1.0	
	T8430	0.8	195	0.25	2.0	105	0.23	2.0	160	0.25	2.0	540	0.30	2.0	40	0.20	1.6	30	0.15	1.0	
	T9315	0.8	265	0.25	2.0	-	-	-	250	0.25	2.0	-	-	-	-	-	-	50	0.15	1.0	
	T9325	0.8	235	0.25	2.0	140	0.23	2.0	220	0.25	2.0	-	-	-	50	0.20	1.6	-	-	-	
WNMG 080412E-SM	T6310	1.2	175	0.30	2.0	125	0.27	2.0	140	0.30	2.0	525	0.36	2.0	50	0.24	1.6	35	0.15	1.0	
	T7325	1.2	195	0.30	2.0	150	0.27	2.0	-	-	-	-	-	60	0.24	1.6	-	-	-		
	T7335	1.2	190	0.30	2.0	145	0.27	2.0	-	-	-	-	-	60	0.24	1.6	-	-	-		
	T8330	1.2	175	0.30	2.0	105	0.27	2.0	165	0.30	2.0	525	0.36	2.0	40	0.24	1.6	35	0.15	1.0	
	T8430	1.2	190	0.30	2.0	105	0.27	2.0	155	0.30	2.0	525	0.36	2.0	40	0.24	1.6	30	0.15	1.0	
	T9315	1.2	260	0.30	2.0	-	-	-	245	0.30	2.0	-	-	-	-	-	-	50	0.15	1.0	
	T9325	1.2	235	0.30	2.0	140	0.27	2.0	220	0.30	2.0	-	-	-	50	0.24	1.6	-	-	-	

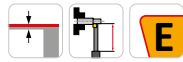
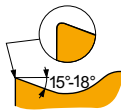

ER-SI geometria positiva destra per operazioni da finitura fino a semi sgrossatura, taglio continuo.

WNMG 060404ER-SI	T8330	0.4	195	0.20	1.7	115	0.18	1.7	-	-	-	585	0.24	1.7	45	0.18	1.4	-	-	-
	T8430	0.4	225	0.20	1.7	120	0.18	1.7	-	-	-	615	0.24	1.7	45	0.18	1.4	-	-	-
	T9325	0.4	270	0.20	1.7	160	0.18	1.7	-	-	-	-	-	-	60	0.18	1.4	-	-	-
WNMG 080404ER-SI	T7325	0.4	220	0.20	1.7	170	0.18	1.7	-	-	-	-	-	-	70	0.18	1.4	-	-	-
	T7335	0.4	215	0.20	1.7	165	0.18	1.7	-	-	-	-	-	-	65	0.18	1.4	-	-	-
	T8315	0.4	205	0.20	1.7	120	0.18	1.7	-	-	-	615	0.24	1.7	50	0.18	1.4	-	-	-
	T8330	0.4	195	0.20	1.7	115	0.18	1.7	-	-	-	585	0.24	1.7	45	0.18	1.4	-	-	-
	T8430	0.4	225	0.20	1.7	120	0.18	1.7	-	-	-	615	0.24	1.7	45	0.18	1.4	-	-	-
WNMG 080408ER-SI	T9325	0.4	270	0.20	1.7	160	0.18	1.7	-	-	-	-	-	-	60	0.18	1.4	-	-	-
	T7325	0.8	215	0.35	1.7	165	0.32	1.7	-	-	-	-	-	-	65	0.25	1.4	-	-	-
	T7335	0.8	205	0.35	1.7	155	0.32	1.7	-	-	-	-	-	-	65	0.25	1.4	-	-	-
	T8315	0.8	205	0.35	1.7	120	0.32	1.7	-	-	-	615	0.42	1.7	50	0.25	1.4	-	-	-
	T8330	0.8	195	0.35	1.7	115	0.32	1.7	-	-	-	585	0.42	1.7	45	0.25	1.4	-	-	-
	T8430	0.8	210	0.35	1.7	115	0.32	1.7	-	-	-	585	0.42	1.7	45	0.25	1.4	-	-	-
	T9325	0.8	255	0.35	1.7	150	0.32	1.7	-	-	-	-	-	-	55	0.25	1.4	-	-	-
WNMG 080412ER-SI	T8430	1.2	225	0.35	1.7	120	0.32	1.7	-	-	-	615	0.42	1.7	45	0.25	1.4	-	-	-
	T9325	1.2	265	0.35	1.7	155	0.32	1.7	-	-	-	-	-	-	55	0.25	1.4	-	-	-

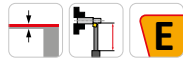
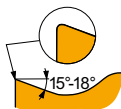











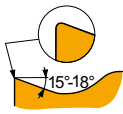



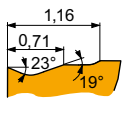



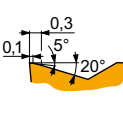

EL-SI geometria positiva sinistra per operazioni da finitura fino a semi sgrossatura, taglio continuo.

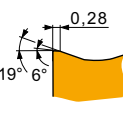
WNMG 060404EL-SI	T8330	0.4	195	0.20	1.7	115	0.18	1.7	-	-	-	585	0.24	1.7	45	0.18	1.4	-	-	-
	T8430	0.4	225	0.20	1.7	120	0.18	1.7	-	-	-	615	0.24	1.7	45	0.18	1.4	-	-	-
	T9325	0.4	270	0.20	1.7	160	0.18	1.7	-	-	-	-	-	-	60	0.18	1.4	-	-	-
WNMG 080404EL-SI	T7325	0.4	220	0.20	1.7	170	0.18	1.7	-	-	-	-	-	-	70	0.18	1.4	-	-	-
	T7335	0.4	215	0.20	1.7	165	0.18	1.7	-	-	-	-	-	-	65	0.18	1.4	-	-	-
	T8315	0.4	205	0.20	1.7	120	0.18	1.7	-	-	-	615	0.24	1.7	50	0.18	1.4	-	-	-
	T8330	0.4	195	0.20	1.7	115	0.18	1.7	-	-	-	585	0.24	1.7	45	0.18	1.4	-	-	-
	T8430	0.4	225	0.20	1.7	120	0.18	1.7	-	-	-	615	0.24	1.7	45	0.18	1.4	-	-	-
	T9325	0.4	270	0.20	1.7	160	0.18	1.7	-	-	-	-	-	-	60	0.18	1.4	-	-	-

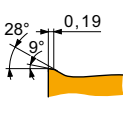

Idoneità e valori iniziali per velocità di taglio (Vc), avanzamento (f) e profondità di taglio (ap). Fare riferimento alla nostra App Machining Calculator per ulteriori calcoli.

Codice prodotto	RE  (mm)	P			M			K			N			S			H			
		vc (m/min)	f (mm/rev)	ap (mm)	vc (m/min)	f (mm/rev)	ap (mm)	vc (m/min)	f (mm/rev)	ap (mm)	vc (m/min)	f (mm/rev)	ap (mm)	vc (m/min)	f (mm/rev)	ap (mm)	vc (m/min)	f (mm/rev)	ap (mm)	
				EL-SI geometria positiva sinistra per operazioni da finitura fino a semi sgrossatura, taglio continuo.																
WNMG 080408EL-SI	T7325 0.8	215	0.35	1.7	165	0.32	1.7	–	–	–	–	–	–	–	65	0.25	1.4	–	–	–
	T7335 0.8	205	0.35	1.7	155	0.32	1.7	–	–	–	–	–	–	–	65	0.25	1.4	–	–	–
	T8315 0.8	205	0.35	1.7	120	0.32	1.7	–	–	–	615	0.42	1.7	50	0.25	1.4	–	–	–	
	T8330 0.8	195	0.35	1.7	115	0.32	1.7	–	–	–	585	0.42	1.7	45	0.25	1.4	–	–	–	
	T8430 0.8	210	0.35	1.7	115	0.32	1.7	–	–	–	585	0.42	1.7	45	0.25	1.4	–	–	–	
	T9325 0.8	255	0.35	1.7	150	0.32	1.7	–	–	–	–	–	–	55	0.25	1.4	–	–	–	
WNMG 080412EL-SI	T8430 1.2	225	0.35	1.7	120	0.32	1.7	–	–	–	615	0.42	1.7	45	0.25	1.4	–	–	–	
				W-F geometria wiper per lavorazioni leggere e finitura con maggiore velocità di avanzamento e finitura superficiale ottimizzata.																
WNMG 060408W-F	T9315 0.8	215	0.45	0.8	–	–	–	200	0.45	0.8	–	–	–	–	–	–	–	–	–	–
	T9325 0.8	190	0.45	0.8	–	–	–	180	0.45	0.8	–	–	–	–	–	–	–	–	–	–
WNMG 080404W-F	T9315 0.4	250	0.25	0.4	–	–	–	235	0.25	0.4	–	–	–	–	–	–	–	–	–	–
	T9325 0.4	225	0.25	0.4	–	–	–	210	0.25	0.4	–	–	–	–	–	–	–	–	–	–
				W-M geometria wiper per operazioni da semi sgrossatura fino a sgrossatura con maggiore velocità di avanzamento e finitura superficiale ottimizzata.																
WNMG 060408W-M	T9310 0.8	220	0.45	1.2	–	–	–	205	0.45	1.2	–	–	–	–	–	–	–	–	–	–
	T9315 0.8	205	0.45	1.2	–	–	–	190	0.45	1.2	–	–	–	–	–	–	–	–	–	–
	T9325 0.8	190	0.45	1.2	–	–	–	180	0.45	1.2	–	–	–	–	–	–	–	–	–	–
WNMG 060412W-M	T5315 1.2	235	0.55	1.2	–	–	–	220	0.55	1.2	–	–	–	–	–	–	–	–	–	–
	T9315 1.2	205	0.55	1.2	–	–	–	190	0.55	1.2	–	–	–	–	–	–	–	–	–	–
	T9325 1.2	180	0.55	1.2	–	–	–	170	0.55	1.2	–	–	–	–	–	–	–	–	–	–
WNMG 080408W-M	T9315 0.8	200	0.45	1.5	–	–	–	190	0.45	1.5	–	–	–	–	–	–	–	–	–	–
	T9325 0.8	185	0.45	1.5	–	–	–	175	0.45	1.5	–	–	–	–	–	–	–	–	–	–
WNMG 080412W-M	T9325 1.2	180	0.55	1.5	–	–	–	170	0.55	1.5	–	–	–	–	–	–	–	–	–	–
				W-MR geometria wiper per operazioni da finitura fino a sgrossatura con maggiore velocità di avanzamento e finitura superficiale ottimizzata.																
WNMG 060408W-MR	T9315 0.8	205	0.45	1.2	–	–	–	190	0.45	1.2	–	–	–	–	–	–	–	–	–	–
	T9325 0.8	190	0.45	1.2	110	0.41	1.2	180	0.45	1.2	–	–	–	–	–	–	–	–	–	–
WNMG 080404W-MR	T9315 0.4	200	0.30	1.5	–	–	–	190	0.30	1.5	–	–	–	–	–	–	–	–	–	–
	T9325 0.4	180	0.30	1.5	105	0.27	1.5	170	0.30	1.5	–	–	–	–	–	–	–	–	–	–
WNMG 080408W-MR	T5315 0.8	230	0.45	1.5	–	–	–	215	0.45	1.5	–	–	–	–	–	–	–	–	–	–
	T9310 0.8	215	0.45	1.5	–	–	–	200	0.45	1.5	–	–	–	–	–	–	–	–	–	–
	T9315 0.8	200	0.45	1.5	–	–	–	190	0.45	1.5	–	–	–	–	–	–	–	–	–	–
	T9325 0.8	185	0.45	1.5	110	0.41	1.5	175	0.45	1.5	–	–	–	–	–	–	–	–	–	–
WNMG 080412W-MR	T5315 1.2	230	0.55	1.5	–	–	–	215	0.55	1.5	–	–	–	–	–	–	–	–	–	–
	T9310 1.2	210	0.55	1.5	–	–	–	195	0.55	1.5	–	–	–	–	–	–	–	–	–	–
	T9315 1.2	200	0.55	1.5	–	–	–	190	0.55	1.5	–	–	–	–	–	–	–	–	–	–
	T9325 1.2	180	0.55	1.5	105	0.50	1.5	170	0.55	1.5	–	–	–	–	–	–	–	–	–	–
				W-NM geometria wiper per operazioni da finitura fino a sgrossatura con maggiore velocità di avanzamento e finitura superficiale ottimizzata.																
WNMG 060408W-NM	T7325 0.8	220	0.25	1.8	170	0.23	1.8	–	–	–	–	–	–	70	0.20	1.4	–	–	–	
	T7335 0.8	215	0.25	1.8	165	0.23	1.8	–	–	–	–	–	–	65	0.20	1.4	–	–	–	
	T9315 0.8	290	0.25	1.8	–	–	–	275	0.25	1.8	–	–	–	–	–	–	–	–	–	–
	T9325 0.8	265	0.25	1.8	155	0.23	1.8	250	0.25	1.8	–	–	–	55	0.20	1.4	–	–	–	



Idoneità e valori iniziali per velocità di taglio (Vc), avanzamento (f) e profondità di taglio (ap). Fare riferimento alla nostra App Machining Calculator per ulteriori calcoli.

Codice prodotto	RE (mm)	P			M			K			N			S			H		
		vc (m/min)	f (mm/rev)	ap (mm)	vc (m/min)	f (mm/rev)	ap (mm)	vc (m/min)	f (mm/rev)	ap (mm)	vc (m/min)	f (mm/rev)	ap (mm)	vc (m/min)	f (mm/rev)	ap (mm)	vc (m/min)	f (mm/rev)	ap (mm)

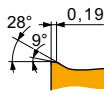

W-NM geometria wiper per operazioni da finitura fino a sgrossatura con maggiore velocità di avanzamento e finitura superficiale ottimizzata.

WNMG 080404W-NM	T7325	0.4	195	0.20	2.1	150	0.18	2.1	-	-	-	-	-	-	60	0.16	1.7	-	-	-
	T7335	0.4	190	0.20	2.1	145	0.18	2.1	-	-	-	-	-	-	60	0.16	1.7	-	-	-
	T9315	0.4	270	0.20	2.1	-	-	-	255	0.20	2.1	-	-	-	-	-	-	-	-	-
	T9325	0.4	240	0.20	2.1	140	0.18	2.1	225	0.20	2.1	-	-	-	50	0.16	1.7	-	-	-
WNMG 080408W-NM	T7325	0.8	215	0.25	2.1	165	0.23	2.1	-	-	-	-	-	-	65	0.20	1.7	-	-	-
	T7335	0.8	210	0.25	2.1	160	0.23	2.1	-	-	-	-	-	-	65	0.20	1.7	-	-	-
	T9315	0.8	290	0.25	2.1	-	-	-	275	0.25	2.1	-	-	-	-	-	-	-	-	-
	T9325	0.8	260	0.25	2.1	155	0.23	2.1	245	0.25	2.1	-	-	-	55	0.20	1.7	-	-	-
WNMG 080412W-NM	T7325	1.2	215	0.30	2.1	165	0.27	2.1	-	-	-	-	-	-	65	0.24	1.7	-	-	-
	T7335	1.2	210	0.30	2.1	160	0.27	2.1	-	-	-	-	-	-	65	0.24	1.7	-	-	-
	T9315	1.2	285	0.30	2.1	-	-	-	270	0.30	2.1	-	-	-	-	-	-	-	-	-

WNMM



	IC (mm)	D1 (mm)	L (mm)	S (mm)
0804	12.700	5.16	8.70	4.76
1006	15.875	6.35	10.80	6.35
1306	19.050	7.94	13.00	6.35

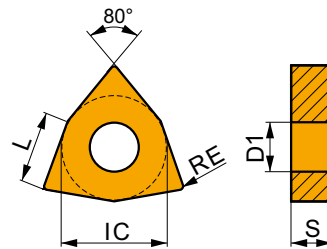

Idoneità e valori iniziali per velocità di taglio (Vc), avanzamento (f) e profondità di taglio (ap). Fare riferimento alla nostra App Machining Calculator per ulteriori calcoli.

Codice prodotto	RE (mm)	P			M			K			N			S			H		
		vc (m/min)	f (mm/rev)	ap (mm)	vc (m/min)	f (mm/rev)	ap (mm)	vc (m/min)	f (mm/rev)	ap (mm)	vc (m/min)	f (mm/rev)	ap (mm)	vc (m/min)	f (mm/rev)	ap (mm)	vc (m/min)	f (mm/rev)	ap (mm)

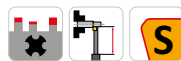
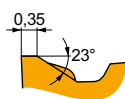

DR geometria per operazioni da semi sgrossatura fino a sgrossatura, da taglio continuo a interrotto.

WNMM 100608E-DR	T9325	0.8	205	0.40	5.0	120	0.36	5.0	190	0.40	5.0	-	-	-	-	-	-	-	-	-
	T9335	0.8	175	0.40	5.0	105	0.36	5.0	-	-	-	-	-	-	-	-	-	-	-	-
WNMM 130612E-DR	T9325	1.2	200	0.45	6.0	120	0.41	6.0	190	0.45	6.0	-	-	-	-	-	-	-	-	-
	T9335	1.2	170	0.45	6.0	100	0.41	6.0	-	-	-	-	-	-	-	-	-	-	-	-

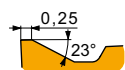

NR geometria per operazioni da semi sgrossatura fino a sgrossatura, da taglio continuo a interrotto.

WNMM 080408E-NR	T7325	0.8	175	0.40	3.0	135	0.36	3.0	-	-	-	-	-	-	55	0.28	2.4	-	-	-
	T8330	0.8	155	0.40	3.0	90	0.36	3.0	145	0.40	3.0	-	-	-	35	0.28	2.4	-	-	-
	T8430	0.8	165	0.40	3.0	90	0.36	3.0	135	0.40	3.0	-	-	-	35	0.28	2.4	-	-	-
	T9325	0.8	195	0.40	3.0	115	0.36	3.0	185	0.40	3.0	-	-	-	40	0.28	2.4	-	-	-

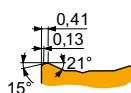
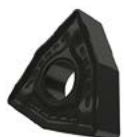



NR2 geometria per operazioni da semi sgrossatura fino a sgrossatura, da taglio continuo a interrotto.

WNMM 080408E-NR2	T7335	0.8	160	0.40	4.0	120	0.36	4.0	-	-	-	-	-	-	50	0.28	3.2	-	-	-
	T9325	0.8	190	0.40	4.0	110	0.36	4.0	180	0.40	4.0	-	-	-	40	0.28	3.2	-	-	-

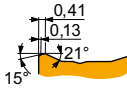

Idoneità e valori iniziali per velocità di taglio (Vc), avanzamento (f) e profondità di taglio (ap). Fare riferimento alla nostra App Machining Calculator per ulteriori calcoli.

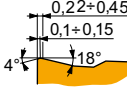
Codice prodotto	RE (mm)	P			M			K			N			S			H			
		vc (m/min)	f (mm/rev)	ap (mm)	vc (m/min)	f (mm/rev)	ap (mm)	vc (m/min)	f (mm/rev)	ap (mm)	vc (m/min)	f (mm/rev)	ap (mm)	vc (m/min)	f (mm/rev)	ap (mm)	vc (m/min)	f (mm/rev)	ap (mm)	
  NR2 geometria per operazioni da semi sgrossatura fino a sgrossatura, da taglio continuo a interrotto.																				
	WNMM 080412E-NR2	T7325	1.2	175	0.45	4.0	135	0.41	4.0	—	—	—	—	—	—	55	0.32	3.2	—	—
	T9325	1.2	190	0.45	4.0	110	0.41	4.0	180	0.45	4.0	—	—	—	40	0.32	3.2	—	—	—
  OR geometria per operazioni da semi sgrossatura fino a sgrossatura, da taglio continuo a interrotto.																				
	WNMM 080408E-OR	T8330	0.8	150	0.40	4.0	90	0.36	4.0	140	0.40	4.0	—	—	—	35	0.28	3.2	—	—
	T8430	0.8	155	0.40	4.0	85	0.36	4.0	130	0.40	4.0	—	—	—	30	0.28	3.2	—	—	—
	T9325	0.8	190	0.40	4.0	110	0.36	4.0	180	0.40	4.0	—	—	—	40	0.28	3.2	—	—	—
	T9335	0.8	165	0.40	4.0	95	0.36	4.0	—	—	—	—	—	—	35	0.28	3.2	—	—	—
WNMM 080412E-OR	T9325	1.2	190	0.45	4.0	110	0.41	4.0	180	0.45	4.0	—	—	—	40	0.36	3.2	—	—	—
	T9335	1.2	170	0.45	4.0	100	0.41	4.0	—	—	—	—	—	—	35	0.36	3.2	—	—	—
WNMM 080416E-OR	T9325	1.6	195	0.50	4.0	115	0.45	4.0	185	0.50	4.0	—	—	—	40	0.40	3.2	—	—	—
WNMM 130612E-OR	T9325	1.2	185	0.45	6.0	110	0.41	6.0	175	0.45	6.0	—	—	—	40	0.36	4.8	—	—	—
WNMM 130616E-OR	T9325	1.6	180	0.50	6.0	105	0.45	6.0	170	0.50	6.0	—	—	—	40	0.40	4.8	—	—	—

WNGA CBN

 PRAMET

	IC (mm)	D1 (mm)	L (mm)	S (mm)
0804	12.700	5.16	8.70	4.76

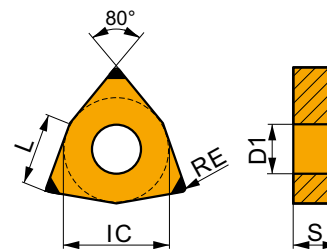

Idoneità e valori iniziali per velocità di taglio (Vc), avanzamento (f) e profondità di taglio (ap). Fare riferimento alla nostra App Machining Calculator per ulteriori calcoli.

Codice prodotto	RE (mm)	P			M			K			N			S			H			
		vc (m/min)	f (mm/rev)	ap (mm)	vc (m/min)	f (mm/rev)	ap (mm)	vc (m/min)	f (mm/rev)	ap (mm)	vc (m/min)	f (mm/rev)	ap (mm)	vc (m/min)	f (mm/rev)	ap (mm)	vc (m/min)	f (mm/rev)	ap (mm)	
  Adatta per operazioni di finitura e taglio continuo.																				
	WNGA 080408S01020C	TB310	0.8	—	—	—	—	—	—	530	0.15	0.6	—	—	—	140	0.11	0.5	110	0.15
  Adatta per operazioni di finitura e taglio continuo.																				
	WNGA080408S01020WC	TB310	0.8	—	—	—	—	—	530	0.15	0.6	—	—	—	140	0.11	0.5	110	0.15	1.0



DWLN(RL) EXT



Utensile esterno, doppio bloccaggio, angolo del tagliente utensile 95°, inserti WN..

Utensile di tornitura esterno destro / sinistro, doppio bloccaggio a staffa, con angolo del tagliente utensile di 95°. Per tornitura longitudinale e sfacciatura con spallamento, conicità e smussatura con inserti WN.. dim. da 06 a 13 negativi. Disponibile con dimensioni stelo 16x16 fino a 40x40 mm. Corpo trattato per una maggiore durata dell'utensile.

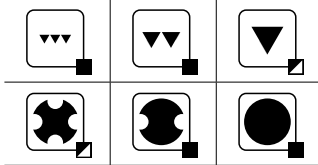
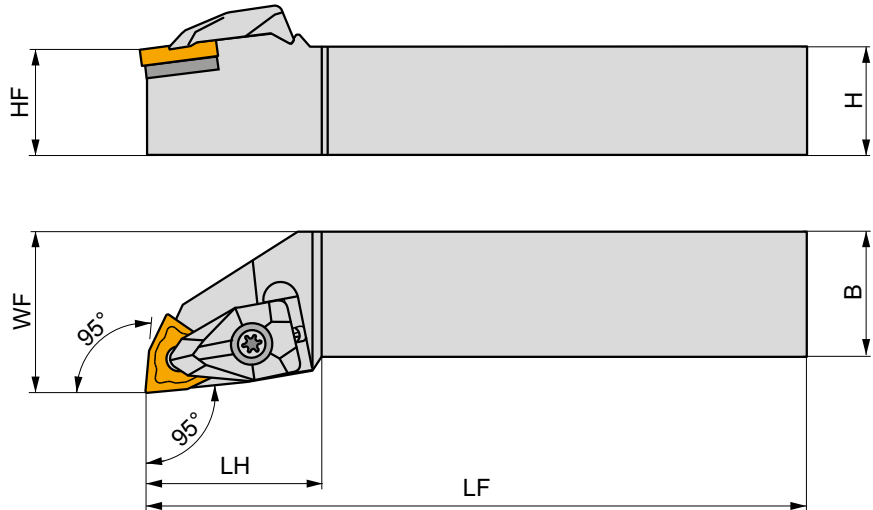
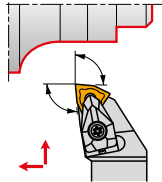

Codice prodotto	H	B	HF	WF	LF	LH	LAMS	GAMO	kg			
	(mm)	(mm)	(mm)	(mm)	(mm)	(mm)	(°)	(°)				
R DWLNR 1616 H 06	16	16	16	20	100	26.4	-6	-6	0.22	GI028	DW06	-
DWLNR 2020 K 06	20	20	20	25	125	27.1	-6	-6	0.41	GI028	DW06	-
DWLNR 2525 M 06	25	25	25	32	150	27.1	-6	-6	0.75	GI028	DW06	-
DWLNR 2020 K 08	20	20	20	25	125	34.3	-6	-6	0.43	GI072	DW08	AT004
DWLNR 2525 M 08	25	25	25	32	150	35	-6	-6	0.75	GI072	DW08	AT004
DWLNR 3225 P 08	32	25	32	32	170	35	-6	-6	1.01	GI072	DW08	AT004
DWLNR 3225 P 10	32	25	32	32	170	38	-6	-6	1.06	GI166	DW10	-
DWLNR 3232 P 13	32	32	32	40	170	40	-6	-6	1.44	GI167	DW13	-
DWLNR 4040 S 13	40	40	40	50	250	41	-6	-6	3.19	GI167	DW13	-
L DWLNL 1616 H 06	16	16	16	20	100	26.4	-6	-6	0.22	GI028	DW06	-
DWLNL 2020 K 06	20	20	20	25	125	27.1	-6	-6	0.41	GI028	DW06	-
DWLNL 2525 M 06	25	25	25	32	150	27.1	-6	-6	0.76	GI028	DW06	-
DWLNL 2020 K 08	20	20	20	25	125	34.3	-6	-6	0.43	GI072	DW08	AT004
DWLNL 2525 M 08	25	25	25	32	150	35	-6	-6	0.75	GI072	DW08	AT004
DWLNL 3225 P 08	32	25	32	32	170	35	-6	-6	1.10	GI072	DW08	AT004
DWLNL 3225 P 10	32	25	32	32	170	38	-6	-6	1.14	GI166	DW10	-
DWLNL 3232 P 13	32	32	32	40	170	40	-6	-6	1.45	GI167	DW13	-
DWLNL 4040 S 13	40	40	40	50	250	41	-6	-6	3.17	GI167	DW13	-



GI028

WN.. 0604..

GI072

WN.. 0804..







GI166



WN.. 1006..

GI167

WN.. 1306..



						
DW06	DCS 09	1.7	DWS 328-01	US 2004-T09P	FLAG T09P	–
DW08	DCS 12	3.9	DWS 331-12	US 2002-T15P	FLAG T15P/3,5	–
DW10	DCS 16	6.4	DWN 100612	US 5018-T20P	–	LK T20P
DW13	DCS 19	6.4	DWN 130612	US 6013-T20P	–	LK T20P

		
AT004a	CER WN.N 0804..	DCS 12C4
AT004b	CER WN.A 0804..	DCS 12C2



MWLN(RL) EXT



Utensile esterno, bloccaggio perno e staffa, angolo del tagliente utensile 95°, inserti WN..

Utensile di tornitura esterno destro / sinistro, bloccaggio perno e staffa, con angolo del tagliente utensile di 95°. Adatto per tornitura longitudinale con spallamento, sfacciatura, conicità e smussi con inserti negativi WN .. 08. Disponibile con dimensioni stelo da 25x25 a 40x40 mm. Corpo trattato per una maggiore durata dell'utensile.

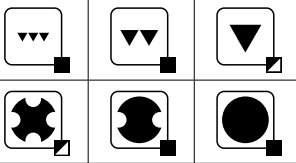
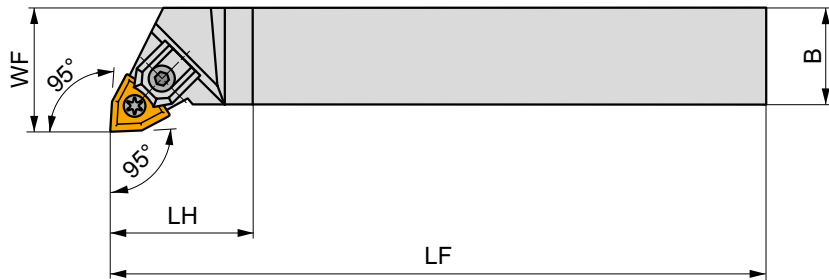
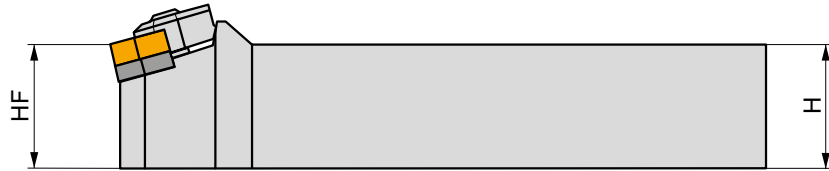
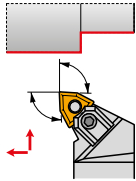

Codice prodotto	H	B	HF	WF	LF	LH	LAMS	GAMO	kg			
	(mm)	(mm)	(mm)	(mm)	(mm)	(mm)	(°)	(°)				
R	MWLN 2525 M 08	25	25	25	32	150	32	-6	-6	0.73	G1072	MW1
	MWLN 3225 P 08	32	25	32	32	170	32	-6	-6	1.30	G1072	MW1
	MWLN 4040 R 08	40	40	40	50	200	32	-6	-6	2.50	G1072	MW1
L	MWLN 2525 M 08	25	25	25	32	150	32	-6	-6	0.70	G1072	MW1
	MWLN 3225 P 08	32	25	32	32	170	32	-6	-6	1.02	G1072	MW1
	MWLN 4040 R 08	40	40	40	50	200	32	-6	-6	2.50	G1072	MW1



G1072



WN..0804..



MW1



UE 05



5.0



WNW 080412



UC 51



HS 0408



HXK 3



PWLN(RL) EXT



PRAMET

P



Utensile esterno, bloccaggio a leva, angolo del tagliente utensile 95°, inserti WN..

Utensile di tornitura esterno destro / sinistro, bloccaggio a leva con angolo del tagliente di 95°. Adatto per tornitura longitudinale con spallamento, sfacciatura, tornitura conica e smussi, con inserti negativi WN .. 06 e 08. Disponibile con dimensioni stelo da 16x16 fino a 32x25 mm. Corpo trattato per una maggiore durata dell'utensile.

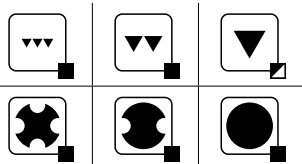
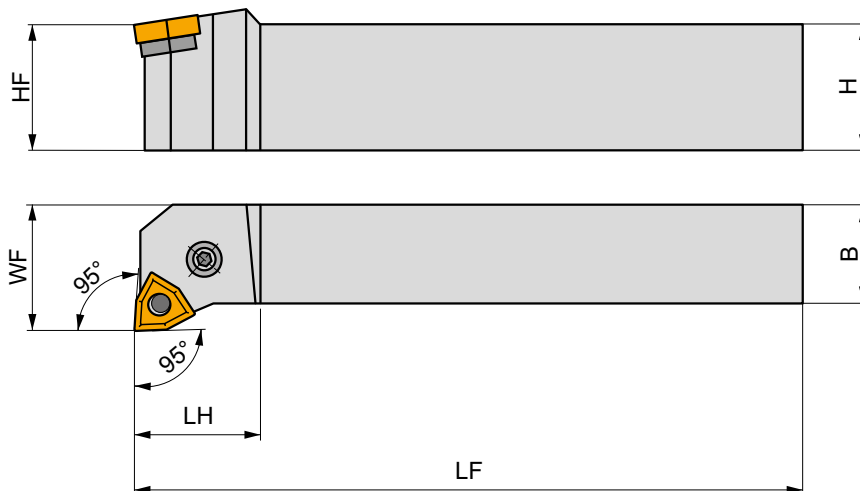
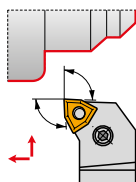

	Codice prodotto	H	B	HF	WF	LF	LH	LAMS	GAMO	kg		
		(mm)	(mm)	(mm)	(mm)	(mm)	(mm)	(°)	(°)			
R	PWLN R 1616 H 0604	16	16	16	20	100	20	-6	-6	0.23	GI028	PW11
	PWLN R 2020 K 0604	20	20	20	25	125	20	-6	-6	0.40	GI028	PW10
	PWLN R 2525 M 0604	25	25	25	32	150	20	-6	-6	0.78	GI028	PW10
	PWLN R 2020 K 08	20	20	20	25	125	22	-6	-6	0.42	GI072	PW22
	PWLN R 2525 M 08	25	25	25	32	150	22	-6	-6	0.73	GI072	PW20
	PWLN R 3225 P 08	32	25	32	32	170	22	-6	-6	1.05	GI072	PW20
L	PWLN L 1616 H 0604	16	16	16	20	100	20	-6	-6	0.21	GI028	PW11
	PWLN L 2020 K 0604	20	20	20	25	125	20	-6	-6	0.40	GI028	PW10
	PWLN L 2525 M 0604	25	25	25	32	150	20	-6	-6	0.75	GI028	PW10
	PWLN L 2020 K 08	20	20	20	25	125	22	-6	-6	0.40	GI072	PW22
	PWLN L 2525 M 08	25	25	25	32	150	22	-6	-6	0.74	GI072	PW20
	PWLN L 3225 P 08	32	25	32	32	170	22	-6	-6	1.05	GI072	PW20



GI028
GI072



WN.. 0604..
WN.. 0804..



PW10

WNU 060308

PU 01

US 34

5.0

M 6x0.75

19

NT 04

MT 04

HXK 3

PW11

WNU 060308

PU 01

US 46

5.0

M 6x0.75

13.2

NT 04

MT 04

HXK 3

PW20

WNU 080312

PU 02

US 35

6.0

M 8x1

22.5

NT 05

MT 05

HXK 4

PW22

WNU 080312

PU 02

US 42

6.0

M 8x1

21

NT 05

MT 05

HXK 4

NEW
C.-DWLN(RL) EXT

D

Utensile esterno PSC a cambio rapido, doppio bloccaggio, angolo del tagliente ut. 95°, inserti WN..

Utensile di tornitura esterno destro / sinistro, doppio bloccaggio a staffa, fori interni per refrigerante, con angolo del tagliente utensile di 95°. Per tornitura longitudinale e sfacciatura con spallamento, conicità e smussatura con inserti WN .. 06 e 08 negativi. Attacco a cambio rapido PSC (Polygon Shank Coupling) dimensioni da C4 a C6. Corpo trattato per una maggiore durata dell'utensile.

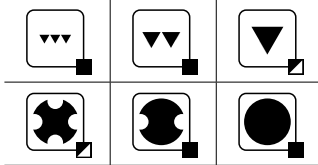
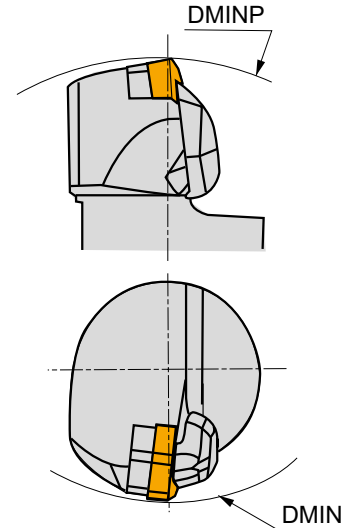
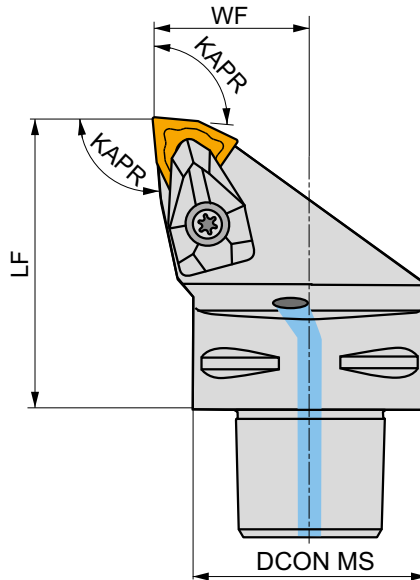
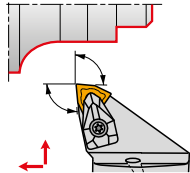

Codice prodotto	DCON MS	DMIN	DMINP	WF	LF	KAPR	LAMS	GAMO					
	(mm)	(mm)	(mm)	(mm)	(mm)	(°)	(°)	(°)					
R	C4-DWLN-27050-06	40	60	140	27	50	95	-6	✓	0.42	GI028	C-DW06	-
	C4-DWLN-27050-08	40	110	140	27	50	95	-6	✓	0.42	GI072	C-DW08-1	AT004
	C5-DWLN-35060-08	50	110	165	35	60	95	-6	✓	0.74	GI072	C-DW08-2	AT004
L	C6-DWLN-45065-08	63	110	190	45	65	95	-6	✓	1.34	GI072	C-DW08-2	AT004
	C4-DWLN-27050-06	40	60	140	27	50	95	-6	✓	0.43	GI028	C-DW06	-
	C4-DWLN-27050-08	40	110	140	27	50	95	-6	✓	0.42	GI072	C-DW08-1	AT004
	C5-DWLN-35060-08	50	110	165	35	60	95	-6	✓	0.76	GI072	C-DW08-2	AT004
C6-DWLN-45065-08	63	110	190	45	65	95	-6	✓	1.34	GI072	C-DW08-2	AT004	

 GI028
 GI072

 WN.. 0604..
 WN.. 0804..

 C-DW06
 C-DW08-1
 C-DW08-2

 DCS 09
 DCS 12
 DCS 12

 1.7
 3.9
 3.9

 DWS 328-01
 DWS 331-12
 DWS 331-12

 US 2004-T09P
 US 2002-T15P
 US 2002-T15P

 FLAG T09P
 FLAG T15P/3,5
 FLAG T15P/3,5

 CN 034-01
 CN 034-01
 CN 045-01

 AT004a
 AT004b

 CER WN.N 0804..
 CER WN.A 0804..

 DCS 12C4
 DCS 12C2



DWLN(RL) INT



PRAMET

D



Utensile interno, doppio bloccaggio, per inserto WN... angolo del tagliente utensile 95°

Bareno destro/sinistro per tornitura interna con doppio bloccaggio a staffa e passaggio refrigerante interno, angolo del tagliente utensile 95° per inserti negativi WN...06 e 08. Diametro interno minimo tornibile Ø32 mm. Per operazioni di tornitura longitudinale, spallamento, conicità e smussi. Disponibile con stelo da Ø25 mm a Ø50 mm. Corpo trattato per una maggiore durata.

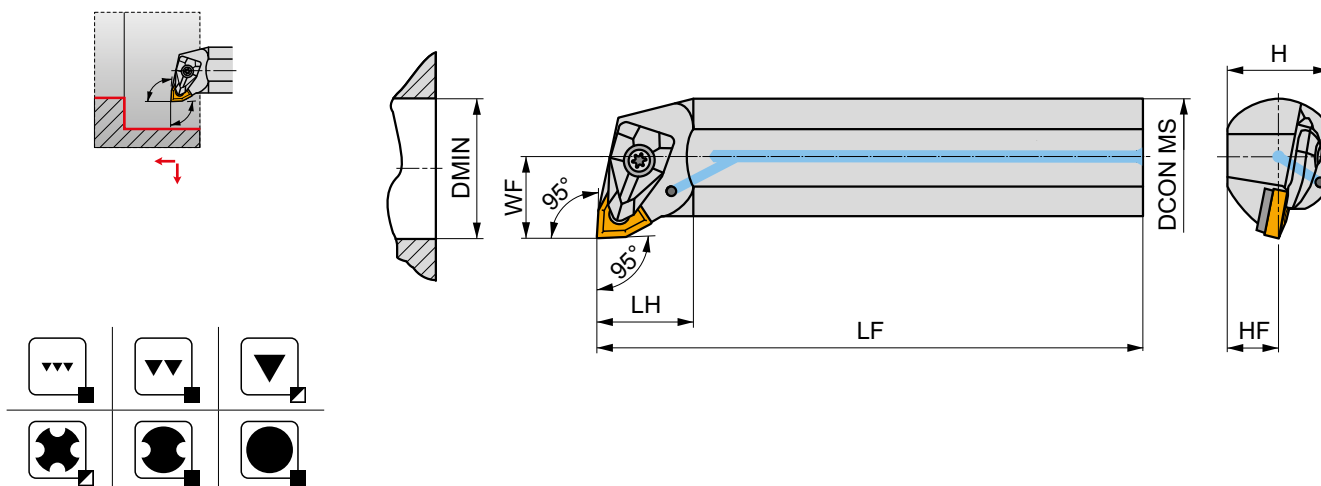

Codice prodotto	DCON MS (mm)	DMIN (mm)	WF (mm)	H (mm)	HF (mm)	LF (mm)	LH (mm)	LAMS (°)	GAMO (°)				
R A25T-DWLNR 06	25	32	17	23	11.5	300	31	-14	-6	✓	0.97	GI028	DW06
A25T-DWLNR 08	25	33	17	23	11.5	300	31	-12	-6	✓	0.98	GI072	DWI08
A32T-DWLNR 08	32	40	22	30	15	300	33	-10	-6	✓	1.71	GI072	DWI08
A40T-DWLNR 08	40	50	27	37	18.5	300	36	-13	-6	✓	2.59	GI072	DW08
A50U-DWLNR 08	50	63	35	47	23.5	350	39	-11	-6	✓	5.24	GI072	DW08
L A25T-DWLNL 06	25	32	17	23	11.5	300	31	-14	-6	✓	0.97	GI028	DW06
A25T-DWLNL 08	25	33	17	23	11.5	300	31	-12	-6	✓	0.98	GI072	DWI08
A32T-DWLNL 08	32	40	22	30	15	300	33	-10	-6	✓	1.70	GI072	DWI08
A40T-DWLNL 08	40	50	27	37	18.5	300	36	-13	-6	✓	2.59	GI072	DW08
A50U-DWLNL 08	50	63	35	47	23.5	350	39	-11	-6	✓	5.25	GI072	DW08



GI028
GI072

WN.. 0604..
WN.. 0804..



DW06
DW08
DWI08

DCS 09
DCS 12
DCS 12

1.7
3.9
3.9

DWS 328-01
DWS 331-12
DWS 328-02

US 2004-T09P
US 2002-T15P
US 2002-T15P

FLAG T09P
FLAG T15P/3,5
FLAG T15P/3,5



PWLN(RL) INT



Utensile interno, bloccaggio a leva, inserti WN... angolo del tagliente utensile 95°

Bareno destro/sinistro per tornitura interna con bloccaggio a leva e passaggio refrigerante interno, angolo del tagliente utensile 95° per inserti negativi WN...06 e 08. Diametro interno minimo tornibile Ø20 mm. Per operazioni di tornitura longitudinale, spallamento, conicità e smussi. Disponibile con stelo da Ø16 mm fino a Ø60 mm. Corpo trattato per una maggiore durata.

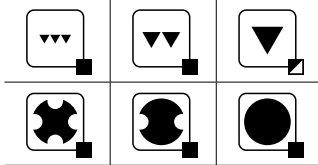
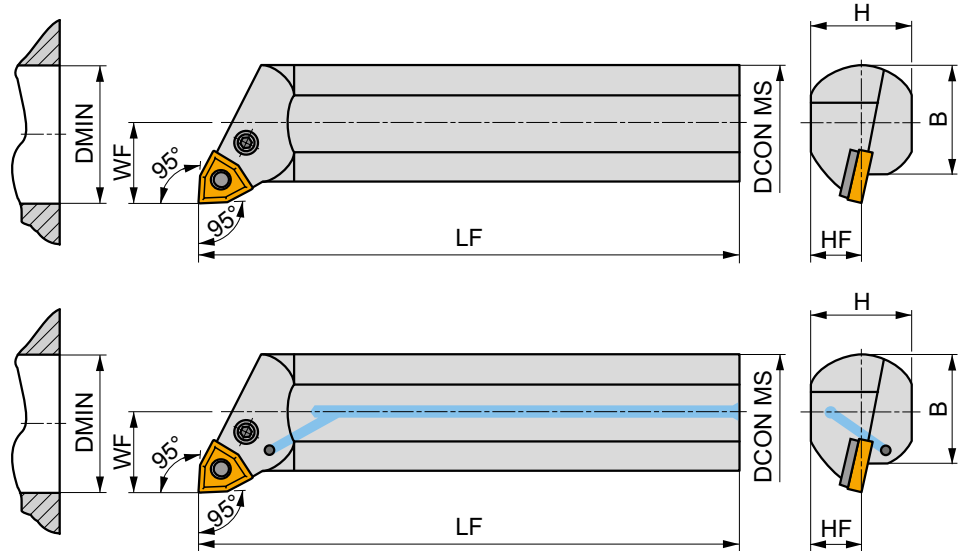
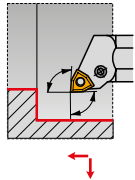

Codice prodotto	DCON MS	DMIN	WF	H	B	LF	LAMS	GAMO				
	(mm)	(mm)	(mm)	(mm)	(mm)	(mm)	(°)	(°)				
R	A16M-PWLN R 0604	16	20	11	15	15	-13.5	-6	✓	0.22	G1028	PW09
	A20Q-PWLN R 0604	20	27	13	18	18	-13.5	-6	✓	0.36	G1028	PW09
	S25T-PWLN R 0604	25	32	17	23	23	-12	-6	-	1.10	G1028	PW11
	A32S-PWLN R 0604	32	40	22	30	30	-12	-6	✓	1.30	G1028	PW11
	A25R-PWLN R 08	25	32	17	23	23	-12	-6	✓	0.66	G1072	PW25
	S25T-PWLN R 08	25	32	17	23	23	-12	-6	-	1.10	G1072	PW25
	A32S-PWLN R 08	32	40	22	30	30	-12	-6	✓	1.46	G1072	PW21
	S32U-PWLN R 08	32	40	22	30	30	-12	-6	-	2.09	G1072	PW21
	A40T-PWLN R 08	40	50	27	38	38	-12	-6	✓	2.40	G1072	PW20
	A50U-PWLN R 08	50	63	35	47	48.5	-12	-6	✓	4.88	G1072	PW20
	A60V-PWLN R 08	60	80	43	57	58.5	-12	-6	✓	8.10	G1072	PW20
	L	A16M-PWLN L 0604	16	20	11	15	15	-13.5	-6	✓	0.22	G1028
A20Q-PWLN L 0604		20	27	13	18	18	-13.5	-6	✓	0.36	G1028	PW09
S25T-PWLN L 0604		25	32	17	23	23	-12	-6	-	0.98	G1028	PW11
A32S-PWLN L 0604		32	40	22	30	30	-12	-6	✓	1.28	G1028	PW11
A25R-PWLN L 08		25	32	17	23	23	-12	-6	✓	0.75	G1072	PW25
S25T-PWLN L 08		25	32	17	23	23	-12	-6	-	1.01	G1072	PW25
A32S-PWLN L 08		32	40	22	30	30	-12	-6	✓	1.47	G1072	PW21
S32U-PWLN L 08		32	40	22	30	30	-12	-6	-	2.08	G1072	PW21
A40T-PWLN L 08		40	50	27	38	38	-12	-6	✓	2.90	G1072	PW20
A50U-PWLN L 08		50	63	35	47	48.5	-12	-6	✓	4.88	G1072	PW20
A60V-PWLN L 08		60	80	43	57	58.5	-12	-6	✓	8.70	G1072	PW20



G1028
G1072



WN.. 0604..
WN.. 0804..



PW09	–	–	PU 3611-A	PS 0512-A	2.0	M 5	12	–	–	HXK 2
PW11	WNU 060308	–	PU 01	US 46	5.0	M 6x0.75	13.2	NT 04	MT 04	HXK 3
PW20	WNU 080312	–	PU 02	US 35	6.0	M 8x1	22.5	NT 05	MT 05	HXK 4
PW21	WNU 080312	–	PU 02	US 41	6.0	M 8x1	17	NT 05	MT 05	HXK 4
PW25	–	–	PU 32	US 46	5.0	M 6x0.75	13.2	–	–	HXK 3

NEW
C.-DWLN(RL) INT

D

Utensile PSC interno a cambio rapido, doppio bloccaggio per inserto WN... angolo del tagliente ut. 95°

Utensile destro/sinistro per tornitura interna, doppio bloccaggio e passaggio refrigerante interno, angolo del tagliente utensile 95°, per tornitura longitudinale, conicità, spallamenti e smussi con inserti WN...06 e WN...08. Diametro interno minimo tornibile Ø27 mm. Adatto per un'ampia gamma di applicazioni di tornitura interna. Disponibile con attacco PSC (Attacco Poligonale) C4. Corpo trattato per una maggiore durata.

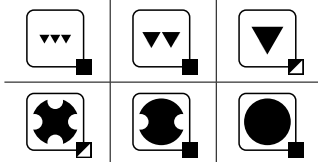
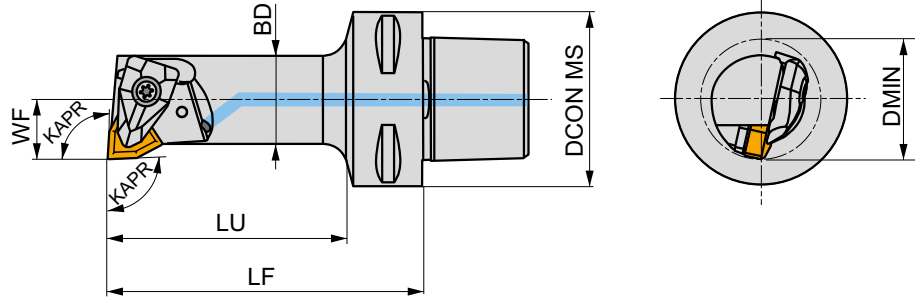
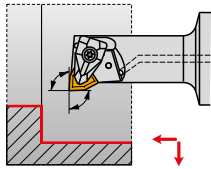

Codice prodotto	DCON MS	DMIN	WF	LF	LU	BD	KAPR	LAMS	GAMO				
	(mm)	(mm)	(mm)	(mm)	(mm)	(mm)	(°)	(°)	(°)				
R C4-DWLN-13075-06	40	27	13	75	52	20	95	-17	-6	✓	0.42	GI028	DW06
	C4-DWLN-17090-08	40	33	17	90	68	25	95	-12	-6	✓	0.53	GI072
L C4-DWLN-13075-06	40	27	13	75	52	20	95	-17	-6	✓	0.42	GI028	DW06
	C4-DWLN-17090-08	40	33	17	90	68	25	95	-12	-6	✓	0.53	GI072

 GI028
 GI072

 WN.. 0604..
 WN.. 0804..

 DW06
 DWI08

 DCS 09
 DCS 12

 1.7
 3.9

 DWS 328-01
 DWS 328-02

 US 2004-T09P
 US 2002-T15P

 FLAG T09P
 FLAG T15P/3,5



TRONCATURA E SCANALATURA





TORNITURA – CONTENUTO GENERALE

6		WMG & ISO 13399
10	TORNITURA ISO	ISTRUZIONI
18		NAVIGATORE
57		INSERTI POSITIVI
219		INSERTI NEGATIVI
386		TRONCATURA E SCANALATURA
482		FILETTATURA
528		STOZZATURA
536		INFORMAZIONI TECNICHE GENERALI



INSERTI PER TRONCATURA E SCANALATURA – PANORAMICA DELLA PAGINA

1 GL. D - GM



	CW	CWTOLL	CWTOLU	INSL
	[mm]	[mm]	[mm]	[mm]
200	2.00	3 -0.05	0.05	25.0
300	3.00	-0.05	0.05	25.0
400	4.00	-0.05	0.05	25.0
500	5.00	-0.05	0.05	25.0
600	6.00	-0.05	0.05	25.0

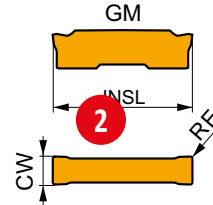

Idoneità e valori iniziali per velocità di taglio (Vc), avanzamento (f) e profondità di taglio (ap). Fare riferimento alla nostra App Machining Calculator per ulteriori calcoli.

Product	RE	P			M			K			N			S			H		
		vc	f	ap	vc	f	ap	vc	f	ap	vc	f	ap	vc	f	ap			
	[mm]	[m/min]	[mm/rev]	[mm]	[m/min]	[mm/rev]	[mm]	[m/min]	[mm/rev]	[mm]	[m/min]	[mm/rev]	[mm]	[m/min]	[mm/rev]	[mm]	[m/min]	[mm/rev]	[mm]



10 GM geometria per operazioni di scanalatura e tornitura longitudinale, taglio continuo e interrotto.

GL2-D200M02-GM	G8330	0.2	190	0.10	0.8	110	0.09	0.8	180	0.10	0.8	-	-	-	45	0.08	0.6	-	-	-
GL2-D300M02-GM	T7325	0.2	220	0.10	0.8	170	0.09	0.8	-	-	-	-	-	-	70	0.08	0.6	-	-	-
GL3-D300M04-GM	T7325	0.2	150	0.20	1.0	90	0.18	1.0	140	0.20	1.0	-	-	-	35	0.14	0.8	-	-	-
GL3-D300M04-GM	G8330	0.4	175	0.20	1.0	135	0.18	1.0	-	-	-	-	-	-	55	0.14	0.8	-	-	-
GL3-D300M04-GM	T7325	0.4	160	0.20	1.0	95	0.18	1.0	150	0.20	1.0	-	-	-	40	0.14	0.8	-	-	-
GL3-D300M04-GM	T7325	0.4	185	0.20	1.0	140	0.18	1.0	-	-	-	-	-	-	60	0.14	0.8	-	-	-
GL4-D400M04-GM	G8330	0.4	150	0.25	1.2	90	0.23	1.2	140	0.25	1.2	-	-	-	35	0.18	1.0	-	-	-
GL4-D400M04-GM	T7325	0.4	170	0.25	1.2	130	0.23	1.2	-	-	-	-	-	-	55	0.18	1.0	-	-	-
GL4-D400M08-GM	G8330	0.8	180	0.25	1.2	105	0.23	1.2	170	0.25	1.2	-	-	-	45	0.18	1.0	-	-	-
GL4-D400M08-GM	T7325	0.8	200	0.25	1.2	155	0.23	1.2	-	-	-	-	-	-	65	0.18	1.0	-	-	-
GL5-D500M08-GM	G8330	0.8	170	0.30	1.2	100	0.27	1.2	160	0.30	1.2	-	-	-	40	0.21	1.0	-	-	-
GL5-D500M08-GM	T7325	0.8	190	0.30	1.2	145	0.27	1.2	-	-	-	-	-	-	60	0.21	1.0	-	-	-
GL6-D600M08-GM	G8330	0.8	170	0.30	1.2	100	0.27	1.2	160	0.30	1.2	-	-	-	40	0.21	1.0	-	-	-

GL5-D500M08-GM:T7325

Al momento dell'ordine utilizzare il codice di specifica dell'inserto completo!

Qualità

Due punti inclusi

Codice inserto ISO



INSERTI PER TRONCATURA E SCANALATURA – PANORAMICA DELLA PAGINA

Pos.	Descrizione	Pos.	Descrizione
1	Designazione dell'inserto	7	Codice inserto ISO
2	Disegno schematico dell'inserto	8	Qualità
3	Tabella con dimensioni inserto (mm)	9	Raggi dell'inserto (mm)
4	Figura dell'inserto rappresentativo	10	Descrizione geometria
5	Profilo del rompitruciolo	11	Campo di applicazione dell'inserto
6	Icone - caratteristiche specifiche e tipo di tagliente		



UTENSILI PER TRONCATURA E SCANALATURA – PANORAMICA DELLA PAGINA

1 GG.(RL) INT



PRAMET



Utensile di Scanalatura interna per inserti LCM...

Bareno destro/sinistro per scanalatura interna per inserti LCM...0313 e 0413. Diametro minimo di scanalatura interna Ø16 mm. Adatto per la scanalatura interna e tornitura multidirezionale. Disponibile con dimensioni dello stelo da Ø16 a Ø32 mm. Corpo trattato per una maggiore durata.

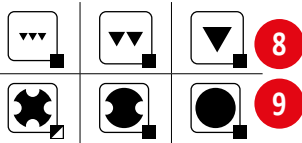
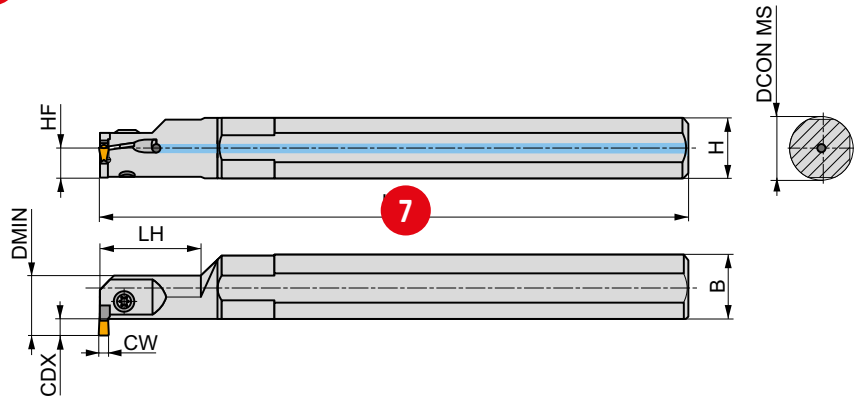
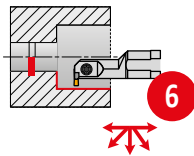

Product	DCON MS [mm]	HF [mm]	H [mm]	B [mm]	L _F [mm]	L _H [mm]	CW [mm]	CDX [mm]	DMIN [mm]		kg		
A16Q-GGER 0313	16	7.5	15	15.5	180	25	3.00	3	16	✓	0.26	GI143	GL06
A16Q-GGER 0313-04	16	7.5	15	15.5	180	25	3.00	3	16	✓	0.26	GI190	GL06
A20R-GGFR 0313	20	9	18	19	200	30	3.00	4.5	20	✓	0.36	GI143	GL06
A20R-GGFR 0313-04	20	9	18	19	200	30	3.00	4.5	20	✓	0.39	GI190	GL06
A25S-GGHR 0313	25	11.5	23	24	250	40	3.00	6.5	25	✓	0.78	GI143	GL06
A25S-GGHR 0413	25	11.5	23	24	250	40	4.00	6.5	25	✓	0.82	GI170	GL06
A32T-GGHL 0413	32	15	30	31	300	50	4.00	9.5	32	✓	1.59	GI170	GL06
A16Q-GGEL 0313	16	7.5	15	15.5	180	25	3.00	3	16	✓	0.29	GI143	GL06
A16Q-GGEL 0313-04	16	7.5	15	15.5	180	25	3.00	3	16	✓	0.28	GI190	GL06
A20R-GGFL 0313	20	9	18	19	200	30	3.00	4.5	20	✓	0.38	GI143	GL06
A20R-GGFL 0313-04	20	9	18	19	200	30	3.00	4.5	20	✓	0.38	GI190	GL06
A25S-GGHL 0313	25	11.5	23	24	250	40	3.00	6.5	25	✓	0.81	GI143	GL06
A25S-GGFL 0413	25	11.5	23	24	250	40	4.00	6.5	25	✓	0.82	GI170	GL06
A32T-GGHL 0413	32	15	30	31	300	50	4.00	9.5	32	✓	1.59	GI170	GL06



GI143	LCM. 0313..
GI170	LCM. 0413..
GI190	LCM. 0313.....04



GL06	SR 85011-T15P	5.0	M 5	9	FLAGT15P
------	---------------	-----	-----	---	----------



UTENSILI PER TRONCATURA E SCANALATURA – PANORAMICA DELLA PAGINA

Pos.	Descrizione
1	Designazione dell'utensile per troncatura e scanalatura
2	Raccomandazioni sul gruppo di materiali
3	Sistema di bloccaggio dell'inserito
4	Figura illustrativa ¹⁾
5	Descrizione dell'utensile
6	Profilo del pezzo da lavorare
7	Disegno schematico dell'utensile
8	Qualità ottenibile della superficie
9	Carattere delle condizioni di taglio/lavorazione
10	Applicazioni del prodotto

Pos.	Descrizione
11	Design dell'utensile
12	Codice dell'utensile
13	Dimensioni [mm] e angoli ²⁾ [°] dell'utensile
14	Alimentazione interna del refrigerante
15	Peso [kg]
16	Gruppo di inserti compatibili ³⁾
17	Gruppo di parti di ricambio ^{3), 4)}
18	Inserti compatibili
19	Parti di ricambio

¹⁾ Gli utensili di tornitura sono di solito rappresentati nella versione destra (R)

²⁾ GAMO = Angolo di spoglia superiore ortogonale (vedere parte tecnica)

LAMS = Angolo di inclinazione del tagliente principale (vedere parte tecnica)

³⁾ Codice gruppo di inserti compatibili, parti di ricambio e accessori sono impiegati solo per esigenze di catalogo e non sono codici validi per ordinazioni.

⁴⁾ Icone di parti di ricambio e di speciali accessori sono rappresentate schematicamente per una facile comprensione. Non sono quindi incluse nella lista di icone. Le viti sono, in alcuni casi, completate con informazioni del momento torcente in Nm, lunghezza e dimensioni del passo.



TRONCATURA E SCANALATURA PANORAMICA DELLE ICONE

ICONE GENERALI

	Utilizzo primario		Finitura – ottima qualità superficiale		Adatto a condizioni di lavorazione stabili
	Utilizzo possibile		Lavorazione media – buona qualità superficiale		Adatto a condizioni di lavorazione instabili
			Sgrossatura – rugosità superficiale illimitata		Adatto a condizioni di lavorazione molto instabili

OPERAZIONI DI TORNITURA

	Copiatura di tornitura (lavorazione multidirezionale)		Scanalatura interna		Scanalatura radiale superficiale
	Scanalatura frontale ampia e profonda (con successiva espansione)		Scanalatura interna (con successiva espansione)		Troncatura di tubi
	Scanalatura frontale profonda		Troncatura		Scanalatura radiale ampia (con successiva espansione)
	Scanalatura radiale profonda		Scanalatura frontale ampia e superficiale (con successiva espansione)		
	Copiatura di tornitura in piano		Scanalatura frontale superficiale		

CARATTERISTICHE

	Prima scelta		Ampia gamma di opzioni universali		Tagliente arrotondato
	Sbalzo ampio		Condizioni di lavoro gravose		Tagliente arrotondato con sfaccettatura

ALTRO

	Coppia di bloccaggio della vite [Nm]		Alimentazione interna del refrigerante
--	--------------------------------------	--	--



INSERTI PER TRONCATURA E SCANALATURA – NAVIGATORE

GL. D **NEW**



 406

LCMF 13



 418

LCMF 16, LCMF 30



 432

LCMF 20



 453

LCMR 13

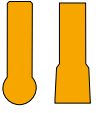

 419

LCMR 16, LCMR 30



 435

LFMX



 456

LFUX



 464

TN R EXT



 475

TN R INT



 475

TN ZZ EXT



 476

TN ZZ INT



 477

X 61 **NEW**



 468

X 61 R **NEW**



 469

X 61 R-1 **NEW**



 473

X 61-1 **NEW**



 472



GEOMETRIE PER TRONCATURA E SCANALATURA – NAVIGATORE

		Tipo di operazione	Scelta della famiglia di inserti			
			Prima scelta	Scelta alternativa		
ESTERNA		Scanalatura	GL. D NEW	LCMF16, LCMF30		
	GM			F		
				406		432
		Troncatura	GL. D NEW	LFMX		
	PM			M2		
			407		457	
	Scanalatura frontale	LCMF13	LCMF16, LCMF30			
F			F			
			418		432	
	Copiatura	GL. D NEW	LCMF16, LCMF30			
MM			MP			
			406		433	
	Scanalatura sedi anelli seeger	X61 NEW	TN ZZ EXT			
			469		476	
INTERNA		Scanalatura	LCMF13			
	F					
				418		
		Copiatura	LCMF13			
	MP					
			419			
	Scanalatura sedi anelli seeger	X61 NEW	TN ZZ INT			
			468		477	



QUALITÀ PER TRONCATURA E SCANALATURA – NAVIGATORE

Identificazione della qualità	Area di applicazione	Applicazione	Avanzamento	Velocità di taglio	Resistenza a condizioni di lavoro avverse	Rivestimento	Colore	Substrato	Vantaggio refrigerante	Descrizione della qualità
T9325	P15 - P35	<input type="checkbox"/>				MT-CVD	FGM	FGM	++	Dal punto di vista tecnologico, si tratta di una qualità estremamente versatile con un'elevata resistenza al danneggiamento meccanico in condizioni di taglio avverse e che conserva una resistenza all'usura eccellente. La corretta applicazione di questo materiale richiede elevate velocità di taglio.
	M10 - M30	<input type="checkbox"/>								
	K15 - K35	<input type="checkbox"/>								
	S10 - S20	<input type="checkbox"/>								
T7325	P15 - P35	<input type="checkbox"/>				MT-CVD	FGM	FGM	+++	Una delle qualità di tornitura più universali. Concepita appositamente per la lavorazione di acciaio inossidabile. Equilibrio ottimale tra resistenza all'usura e affidabilità operativa. Adatta per un'ampia varietà di applicazioni nelle operazioni di tornitura.
	M10 - M25	<input type="checkbox"/>								
	S10 - S25	<input type="checkbox"/>								
6640	P20 - P40	<input type="checkbox"/>				MT-CVD	H	H	+++	Uno dei materiali di tornitura più tenaci che può essere impiegato, specialmente nelle operazioni di sgrossatura, oppure nei casi in cui l'affidabilità operativa in condizioni di taglio avverse rappresenta una priorità. Un'altra scelta ideale per macchine che operano con velocità di taglio da basse a medie e ritmi di avanzamento da medi ad alti.
	M20 - M35	<input type="checkbox"/>								
	K25 - K40	<input type="checkbox"/>								
T8330	P25 - P40	<input type="checkbox"/>				PVD	submicron H	submicron H	+++	Materiale da taglio versatile, è utile per la lavorazione di tutti i tipi di materiali lavorati ed è applicabile a quasi tutti i tipi di operazioni di tornitura. I suoi principali vantaggi sono l'elevata affidabilità operativa e caratteristiche di attrito molto buone; è pertanto idoneo per applicazioni a velocità di taglio medie e più basse.
	M20 - M35	<input type="checkbox"/>								
	K20 - K40	<input type="checkbox"/>								
	N15 - N30	<input type="checkbox"/>								
	S15 - S25	<input type="checkbox"/>								
G8330	P25 - P40	<input type="checkbox"/>				PVD	submicron H	submicron H	+++	Qualità universale per applicazioni di scanalatura e troncatura. Questa qualità è caratterizzata dalla sua eccezionale affidabilità e versatilità. Sviluppata per adattarsi alle condizioni di lavorazione per la maggior parte dei materiali dei pezzi da lavorare.
	M20 - M35	<input type="checkbox"/>								
	K20 - K40	<input type="checkbox"/>								
	S15 - S25	<input type="checkbox"/>								

Substrato

H	Substrato in base WC-Co
submicron H	Substrato in base WC-Co a grana fine (< 1 µm)
FGM	Substrato a gradiente funzionale

Rivestimento

MT-CVD	Rivestimento chimico a media temperatura
PVD	Rivestimento fisico a media temperatura

Benefici del liquido refrigerante

+++	L'utilizzo del refrigerante è essenziale
++	Estremamente raccomandato

TAGLIO E SCANALATURA ESTERNA

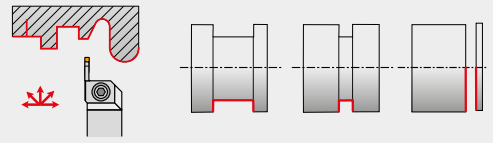

<p>GLSF(RL) EXT NEW</p> <p>GL.D GL2 GL3 GL4 GL5 GL6</p> <p>20×20 25×25</p> <p>410 406 – 408</p>	<p>GLSF(RL) EXT-G NEW</p> <p>GL.D GL2 GL3 GL4 GL5 GL6</p> <p>20×20 25×25</p> <p>412 406 – 408</p>	<p>GLSF(RL) EXT-S NEW</p> <p>GL.D GL2 GL3 GL4</p> <p>12×12 16×16</p> <p>413 406 – 408</p>	<p>GFK(RL) EXT</p> <p>LCMF 0220</p> <p>16×16 25×25</p> <p>455 418 – 454</p>
<p>GFI(RL) EXT</p> <p>LCMF, LCMR 0316 0416 0516 0616 0830</p> <p>16×16 32×25</p> <p>437 418 – 454</p>	<p>GFM(RL) EXT</p> <p>LCMF, LCMR 0316 0416 0516 0616 0830</p> <p>20×20 32×25</p> <p>439 418 – 454</p>	<p>P61 (RL) EXT NEW</p> <p>X61</p> <p>16×16 25×25</p> <p>470 468 – 469</p>	<p>XLCF(RL)</p> <p>LFUX 03 04 05 06</p> <p>16×12 32×25</p> <p>465 464</p>
<p>XLCCN 25 BS + MS-EN</p> <p>LCMF, LCMR 0316 0416 0516 0616</p> <p>25×25 32×25</p> <p>442, 443 418 – 454</p>	<p>XLCF(NRL) BS + MS-EN</p> <p>LFMX 1.50 1.60 2.00 2.20 3.10 4.10 5.10 6.35</p> <p>12×12 32×25</p> <p>461, 463 456 – 458</p>		
<p>GLS B + DU, D NEW</p> <p>GL.D GL2 GL3 GL4 GL5 GL6</p> <p>20×20 32×29</p> <p>414, 415 406 – 409</p>	<p>XLCCN B + DU, D</p> <p>LCMF, LCMR 0316 0416 0516 0616</p> <p>20×20 32×29</p> <p>440, 441 418 – 454</p>	<p>XLCFN B + DU, D</p> <p>LFMX 1.50 1.60 2.00 2.20 3.10 4.10 5.10 6.35</p> <p>20×20 40×36</p> <p>459, 460 456 – 458</p>	<p>XLCFN B LFUX + DU, D</p> <p>LFUX 03 04 05 06</p> <p>20×20 40×40</p> <p>466, 467 464</p>

SCANALATURA FRONTALE

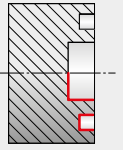

GFIL-L AXIAL	
LCMF, LCMR	
0313 0316	
	17-30 140-230
422, 444	418 – 454

GFIL-R AXIAL	
LCMF, LCMR	
0313 0316 0413 0416	
	17-30 140-230
423, 445	418 – 454

GFIR-L AXIAL	
LCMF, LCMR	
0313 0316 0413 0416	
	17-30 140-230
424, 446	418 – 454

GFIR-R AXIAL	
LCMF, LCMR	
0313 0316	
	17-30 140-230
425, 447	418 – 454

GFML-L AXIAL	
LCMF, LCMR	
0413 0416	
	17-30 140-230
426, 448	418 – 454

GFML-R AXIAL	
LCMF, LCMR	
0413 0416	
	17-30 140-230
427, 449	418 – 454

GFMR-L AXIAL	
LCMF, LCMR	
0413 0416	
	17-30 140-230
428, 450	418 – 454

GFMR-R AXIAL	
LCMF, LCMR	
0413 0416	
	17-30 140-230
429, 451	418 – 454

GGI(RL)-90 AXIAL	
LCMF, LCMR	
0313 0316	
	17-30 110-170
430, 452	418 – 454

XLXFL BS AXIAL + MS-EN	
LFMX	
3.10	
	60-85 150-280
462, 463	456 – 458

SCANALATURA INTERNA

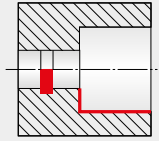

GG.(RL) INT	
	LCMF, LCMR
	 0313 0413
	$\frac{16}{32}$
 421	 418 – 454

P61 (RL) INT NEW	
	X61
	$\frac{16}{40}$
 471	 468

P61S(RL)-1 INT NEW	
	X61-1
	12.5
 474	 472



INSERTI DI TRONCATURA E SCANALATURA – DESIGNAZIONE CODICE GL

1	2		3	4	5	6	7	8	
GL	3	-	D	300	G	02	L06	-	PM



1	2	3	4
Gruppo utensile	Dimensione sede	Numero di taglienti	Larghezza di taglio- CW

1, 2, 3, 4, 5, 6

GL

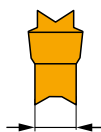

S	Un tagliente
D	Due taglienti



	CW
	CW
200	2.00
250	2.50
300	3.00
400	4.00
500	5.00
600	6.00

5	6	7	8
Tagliente	Raggio di punta	Angolo di inclinazione tagliente	Denominazione rompitrucolo

G	rettificato
M	sinterizzato

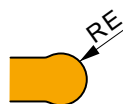
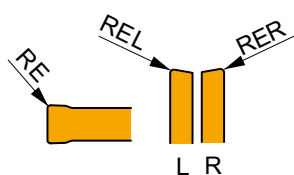

GEOMETRIA A TESTA SFERICA

	RE, RER, REL (mm)
02	0.2
03	0.3
04	0.4
08	0.8

	RE (mm)
MO	$RE = CW/2$

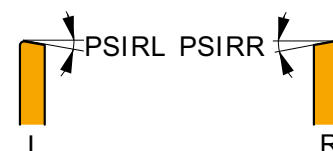

	(°)
06	6
12	12

PM
PR
GM
MM



UTENSILI PER TRONCATURA E SCANALATURA (TORNITURA ESTERNA) - DESIGNAZIONE CODICE GL

1	2	3	4	5	6	7	8	9	10	11
GL	3	-	S	2525	M	F	-	20	-	R
										120
										090

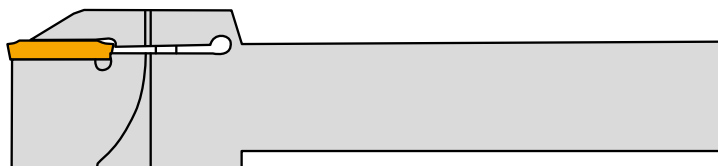

1	2	3	4
Gruppo utensile	Dimensione sede	Tipo di stelo	Dimensioni stelo

GL

1, 2, 3, 4, 5, 6

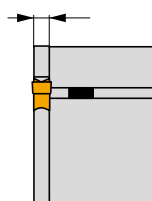

A	Con passaggio refrigerante interno
S	Senza passaggio refrigerante interno

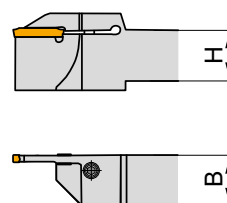

	H/B (mm)/(mm)
1212	12/12
1616	16/16
2020	20/20
2525	25/25

5	6	7	8
Lunghezza totale utensile - LF	Tipo di utensile - Angolo di taglio	Versione (R destra, L sinistra)	Profondità di taglio massima CDX

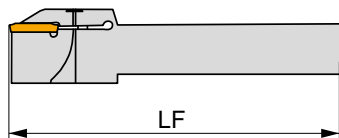

	LF (mm)
H	100
K	125
M	150
P	170

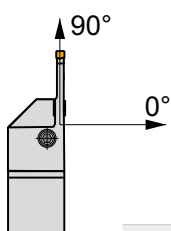

	(°)
G	0
F	90

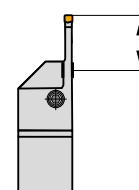
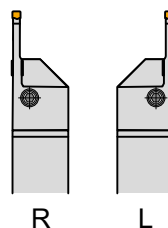

9	10	11
Direzione curvatura lama	Diametro massimo	Diametro massimo scanalatura frontale

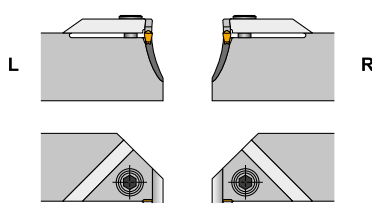

Informazioni aggiuntive per scanalatura frontale.

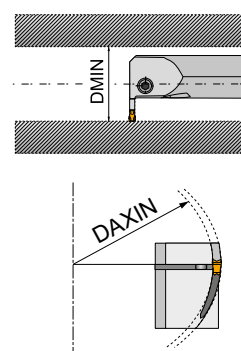
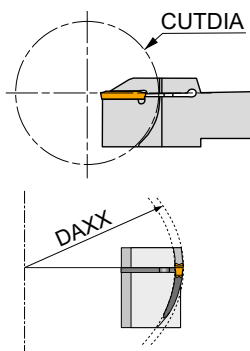



LAME PER TRONCATURA – DESIGNAZIONE CODICE GL

1	2	3	4	5	6
GL	3	-	S	32	M B



1	2	3
Gruppo utensile	Dimensione sede	Tipo di stelo

1, 2, 3, 4, 5, 6

GL

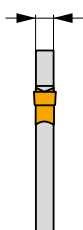

A	con refrigerante interno
S	senza refrigerante interno

4	5	6
Dimensioni stelo	Lunghezza totale lama - LF	Tipo di utensile



	H (mm)
26	26
32	32

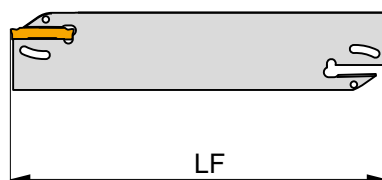

	LF (mm)	LF (")
K	125	5.000"
M	150	6.000"

B - lama



INSERTI – CODICE D'IDENTIFICAZIONE ISO

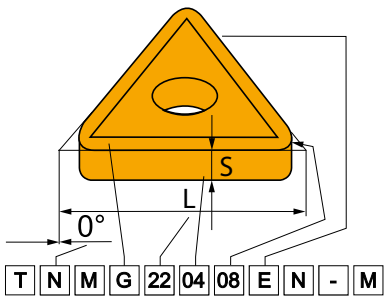

ISO

ANSI

	1	2	3	4
T	T	N	U	N
T	T	N	M	G
1	2	3	4	
T	N	U		
T	N	M		G

1				2				4					
Forma inserto				Angolo di spoglia inferiore				Tipologia inserto					
H 	O 	P 	R 	A 	B 	C 	D 	N 	R 	F 	A 	M 	G
S 	T 	C 	D 	E 	F 	G 	N 	W 	T 	Q 	U 	B 	H
E 	M 	V 	W 	P 	O Special			J 	X Special				

3		3				
Tolleranze						
	(mm)			(")		
	M (±)	S (±)	IC (±)	M (±)	S (±)	IC (±)
A	0.005	0.025	0.025	.0002"	.001"	.0010"
F	0.005	0.025	0.013	.0002"	.001"	.0005"
C	0.013	0.025	0.025	.0005"	.001"	.0010"
H	0.013	0.025	0.013	.0005"	.001"	.0005"
E	0.025	0.025	0.025	.0010"	.001"	.0010"
G	0.025	0.130	0.025	.0010"	.005"	.0010"
J	0.005	0.025	0.05 – 0.13	.0002"	.001"	.002 – 0.005"
K	0.013	0.025	0.05 – 0.13	.0005"	.001"	.002 – 0.005"
L	0.025	0.025	0.05 – 0.13	.0010"	.001"	.002 – 0.005"
M	0.08 – 0.18	0.130	0.05 – 0.13	.003 – 0.007"	.005"	.002 – 0.005"
N	0.08 – 0.18	0.025	0.05 – 0.13	.003 – 0.007"	.001"	.002 – 0.005"
U	0.05 – 0.38	0.130	0.05 – 0.13	.005 – 0.015"	.005"	.003 – 0.010"

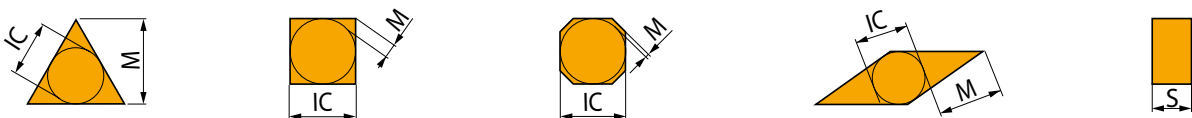



INSERTI – CODICE D'IDENTIFICAZIONE ISO

5	6	7	8	9	10
22	04	08	E	N	M
22	04	08	E	N	M
5	6	7	8	9	10
4	3	2	E	N	M
4	3	2	E	N	M

5		5												
Lunghezza del tagliente (dimensione inserto)														
d = IC		H	O	P	S	T	C	D	E	M	V	W	R	K
(mm)	(in)													
3.97	5/32"				03	06		04			06	02		
4.76	3/16"				04	08	04	05	04	04	08	L3		
5.56	7/32"				05	09	05	06	05	05	09	03		
6.35	1/4"	03	02	04	08	11	06	07	08	08	11	04	06	
7.94	5/16"	04	03	05	07	13	08	09	06	07	13	05	07	
9.525	3/8"	05	04	07	09	16	09	11	09	09	16	06	09	16
12.7	1/2"	07	05	09	12	22	12	15	13	12	22	08	12	
15.875	5/8"	09	06	11	15	27	16	19	16	15	27	10	15	
19.05	3/4"	11	07	13	19	33	19	23	19	19	33	13	19	
25.40	1"	14	10	18	25	44	25	31	26	25	44	17	25	
31.75	1 1/4"	18	13	23	31	54	32	38	32	31	54	21	31	

6	
Spessore inserto	
	s
	(mm) (")
01	1.59 1/16"
T1	1.98 5/64"
02	2.38 3/32"
03	3.18 1/8"
T3	3.97 5/32"
04	4.76 3/16"
05	5.56 7/32"
06	6.35 1/4"
07	7.94 5/16"
09	9.52 3/8"

7	
Raggio di punta inserto	
	RE
	(mm) (")
00	0 0"
02	0.2 1/128"
04	0.4 1/64"
08	0.8 1/32"
12	1.2 3/64"
16	1.6 1/16"
24	2.4 3/32"
32	3.2 1/8"
Inserto Tondo	
d = I.C.	
(")	00
(mm)	M0

ANSI						
5		6		7		
Cerchio inscritto		Spessore inserto		Raggio di punta inserto		
Symbol d = I.C.		Symbol S		Symbol RE		
		(mm) (")		(mm) (")		
1	3.175 1/8"	1	1.588 1/16"	0	0	0"
1.2	3.969 5/32"	1.2	1.984 5/64"	0.2	0.099	1/256"
1.5	4.763 3/16"	1.5	2.381 3/32"	0.5	0.198	1/128"
1.8	5.556 7/32"	2	3.175 1/8"	1	0.397	1/64"
2	6.350 1/4"	2.5	3.969 5/32"	2	0.794	1/32"
2.5	7.938 5/16"	3	4.763 3/16"	3	1.191	3/64"
3	9.525 3/8"	3.5	5.556 7/32"	4	1.588	1/16"
4	12.700 1/2"	4	6.350 1/4"	5	1.984	5/64"
5	15.875 5/8"	5	7.938 5/16"	6	2.381	3/32"
6	19.050 3/4"	6	9.525 3/8"	7	2.778	7/64"
7	22.225 7/8"	7	11.113 7/16"	8	3.175	1/8"
8	25.400 1"	8	12.700 1/2"	10	3.969	5/32"
10	31.750 5/4"	9	14.288 9/16"	12	4.763	3/16"
12	38.100 6/4"	10	15.875 5/8"	14	5.556	7/32"
				16	6.350	1/4"

8		8	
Microgeometria del tagliente			
	Tagliente vivo		Tagliente arrotondato
	Tagliente con piano di rinforzo		Tagliente arrotondato con piano di rinforzo
	Tagliente con doppio piano di rinforzo		Tagliente arrotondato con doppio piano di rinforzo

9		9	
Direzione avanzamento			
	Avanzamento ←		Avanzamento ← Avanzamento →
	Avanzamento →		
10		10	
Designazione romptruciolo			



UTENSILI PER TRONCATURA E SCANALATURA – TORNITURA ESTERNA – DESIGNAZIONE CODICE ISO

ISO	1	2	3	4	5	6	7	8	9	10	11
ANSI	1	2	3	4	5 & 6	7	8	9	10	11	
G	F	I	L	25	25	M	0316	R	030	017	
G	F	I	L	16	D	0316	R	1.18	.670		

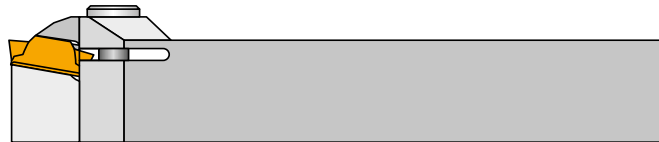

1	1	2	2	3	3	4	4
Tipo di bloccaggio		Tipo di utensile - angolo di taglio		Profondità di taglio massima – CDX		Versione (R destra, L sinistra)	

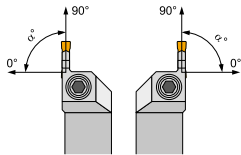
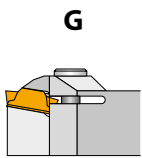

α°	
G = 0°	K = 75°
R = 15°	F = 90°
T = 30°	B = 105°
S = 45°	E = 120°
W = 60°	D = 135°



G = 2.0 × CW	N = 5.5 × CW
H = 2.5 × CW	O = 6.0 × CW
I = 3.0 × CW	P = 6.5 × CW
J = 3.5 × CW	Q = 7.0 × CW
K = 4.0 × CW	R = 7.5 × CW
L = 4.5 × CW	S = 8.0 × CW
M = 5.0 × CW	T = 8.5 × CW

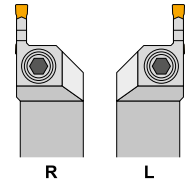

5	6	7	7	8	8
Altezza utensile (mm)		Larghezza utensile (mm)		Lunghezza totale utensile	

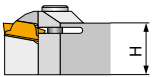

12 = 12 mm
16 = 16 mm
20 = 20 mm
etc.

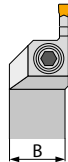

12 = 12 mm
16 = 16 mm
20 = 20 mm
etc.

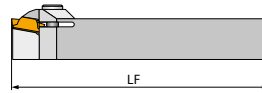

	LF (mm)		LF (")
H	100	A	4.000"
J	110	B	4.500"
K	125	C	5.000"
L	140	D	6.000"
M	150	E	7.000"
N	160	F	8.000"
P	170		
Q	180		
R	200		

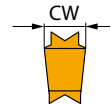

	CW (mm)	CW (")
02	2.0	.079"
03, 0313, 0316	3.0	.118"
04, 0413, 0416	4.0	.157"
05, 0516	5.0	.197"
06, 0616	6.0	.236"
08, 0830	8.0	.315"

5 & 6		
	B (")	H (")
05	5/16"	5/16"
06	3/8"	3/8"
08	1/2"	1/2"
10	5/8"	5/8"
12	3/4"	3/4"
16	1"	1"
85	1"	1 1/4"
86	1"	1 1/2"
20	1 1/4"	1 1/4"
24	1 1/2"	1 1/2"
32	2"	2"

Per steli quadrati, indica, in sedicesimi di pollice, larghezza e altezza. Per steli rettangolari, la prima cifra indica la larghezza, in ottavi di pollice. La seconda cifra indica l'altezza, in quarti di pollice.

10	10
Diametro massimo scanalatura frontale	
Informazioni aggiuntive per scanalatura frontale.	

9	9
Direzione curvatura lama	
Informazioni aggiuntive per scanalatura frontale.	

11	11
Diametro massimo - scanalatura frontale	
Informazioni aggiuntive per scanalatura frontale.	



UTENSILI PER TRONCATURA E SCANALATURA - TORNITURA INTERNA - DESIGNAZIONE CODICE ISO

ISO	1	2	3	-	4	5	6	7	8
ANSI	A	25	S	-	G	G	H	L	0313
	1	2	3		4	5	6	7	8
	A	16	S	-	G	G	H	L	0313



	1		2		3	
	Tipo di stelo		Diametro stelo		Lunghezza totale utensile	
S	Con foro per passaggio refrigerante					
			DCON MS [mm]	DCON MS (")	LF [mm]	LF (")
A	Senza foro per passaggio refrigerante		12	.500"	S	10.000"
			16	.625"	P	12.000"
			20	.750"	Q	14.000"
			25	1.000"	U	15.750"
			32	1.250"	R	15.750"
			40	1.500"		

4		5		6													
Tipo di bloccaggio		Angolo di taglio		Profondità di taglio massima - CDX													
G																	
		α°		<table border="1" style="width: 100%; border-collapse: collapse;"> <tr> <td>E = 1.0 × CW</td> <td>J = 3.5 × CW</td> </tr> <tr> <td>F = 1.5 × CW</td> <td>K = 4.0 × CW</td> </tr> <tr> <td>G = 2.0 × CW</td> <td>L = 4.5 × CW</td> </tr> <tr> <td>H = 2.5 × CW</td> <td>M = 5.0 × CW</td> </tr> <tr> <td>I = 3.0 × CW</td> <td>N = 5.5 × CW</td> </tr> <tr> <td colspan="2" style="text-align: center;">X = Speciale</td> </tr> </table>		E = 1.0 × CW	J = 3.5 × CW	F = 1.5 × CW	K = 4.0 × CW	G = 2.0 × CW	L = 4.5 × CW	H = 2.5 × CW	M = 5.0 × CW	I = 3.0 × CW	N = 5.5 × CW	X = Speciale	
E = 1.0 × CW	J = 3.5 × CW																
F = 1.5 × CW	K = 4.0 × CW																
G = 2.0 × CW	L = 4.5 × CW																
H = 2.5 × CW	M = 5.0 × CW																
I = 3.0 × CW	N = 5.5 × CW																
X = Speciale																	
		G = 0°	K = 75°														
		R = 15°	F = 90°														
		T = 30°	B = 105°														
		S = 45°	E = 120°														
		W = 60°	D = 135°														

7		8	
Versione (R destra, L sinistra)		Dimensione inserto	
		CW [mm]	
		0313	3.0
		0413	4.0

NEW**GL. D - GM**

PRAMET

	CW	CWTOLL	CWTOLU	INSL
	(mm)	(mm)	(mm)	(mm)
200	2.00	-0.05	0.05	25.0
300	3.00	-0.05	0.05	25.0
400	4.00	-0.05	0.05	25.0
500	5.00	-0.05	0.05	25.0
600	6.00	-0.05	0.05	25.0

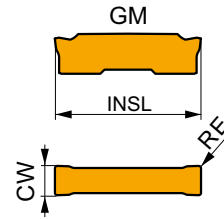

Idoneità e valori iniziali per velocità di taglio (Vc), avanzamento (f) e profondità di taglio (ap). Fare riferimento alla nostra App Machining Calculator per ulteriori calcoli.

Codice prodotto	RE	P			M			K			N			S			H		
		vc	f	ap	vc	f	ap	vc	f	ap	vc	f	ap	vc	f	ap	vc	f	ap
	(mm)	(m/min)	(mm/rev)	(mm)	(m/min)	(mm/rev)	(mm)	(m/min)	(mm/rev)	(mm)	(m/min)	(mm/rev)	(mm)	(m/min)	(mm/rev)	(mm)	(m/min)	(mm/rev)	(mm)

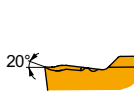

GM geometria per operazioni di scanalatura e tornitura longitudinale, taglio continuo e interrotto.

GL2-D200M02-GM	G8330	0.2	■	190	0.10	0.8	■	110	0.09	0.8	■	180	0.10	0.8	–	–	–	■	45	0.08	0.6	–	–	–
	T7325	0.2	■	220	0.10	0.8	■	170	0.09	0.8	–	–	–	–	–	–	–	■	70	0.08	0.6	–	–	–
GL3-D300M02-GM	G8330	0.2	■	150	0.20	1.0	■	90	0.18	1.0	■	140	0.20	1.0	–	–	–	■	35	0.14	0.8	–	–	–
	T7325	0.2	■	175	0.20	1.0	■	135	0.18	1.0	–	–	–	–	–	–	–	■	55	0.14	0.8	–	–	–
GL3-D300M04-GM	G8330	0.4	■	160	0.20	1.0	■	95	0.18	1.0	■	150	0.20	1.0	–	–	–	■	40	0.14	0.8	–	–	–
	T7325	0.4	■	185	0.20	1.0	■	140	0.18	1.0	–	–	–	–	–	–	–	■	60	0.14	0.8	–	–	–
GL4-D400M04-GM	G8330	0.4	■	150	0.25	1.2	■	90	0.23	1.2	■	140	0.25	1.2	–	–	–	■	35	0.18	1.0	–	–	–
	T7325	0.4	■	170	0.25	1.2	■	130	0.23	1.2	–	–	–	–	–	–	–	■	55	0.18	1.0	–	–	–
GL4-D400M08-GM	G8330	0.8	■	180	0.25	1.2	■	105	0.23	1.2	■	170	0.25	1.2	–	–	–	■	45	0.18	1.0	–	–	–
	T7325	0.8	■	200	0.25	1.2	■	155	0.23	1.2	–	–	–	–	–	–	–	■	65	0.18	1.0	–	–	–
GL5-D500M08-GM	G8330	0.8	■	170	0.30	1.2	■	100	0.27	1.2	■	160	0.30	1.2	–	–	–	■	40	0.21	1.0	–	–	–
	T7325	0.8	■	190	0.30	1.2	■	145	0.27	1.2	–	–	–	–	–	–	–	■	60	0.21	1.0	–	–	–
GL6-D600M08-GM	G8330	0.8	■	170	0.30	1.2	■	100	0.27	1.2	■	160	0.30	1.2	–	–	–	■	40	0.21	1.0	–	–	–
	T7325	0.8	■	190	0.30	1.2	■	145	0.27	1.2	–	–	–	–	–	–	–	■	60	0.21	1.0	–	–	–

NEW**GL. D - MM**

PRAMET

	CW	CWTOLL	CWTOLU	INSL
	(mm)	(mm)	(mm)	(mm)
200	2.00	-0.05	0.05	25.0
300	3.00	-0.05	0.05	25.0
400	4.00	-0.05	0.05	25.0
500	5.00	-0.05	0.05	26.0
600	6.00	-0.05	0.05	26.0

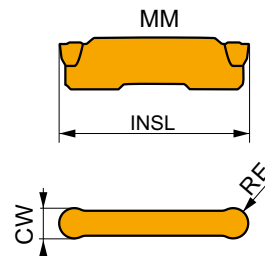

Idoneità e valori iniziali per velocità di taglio (Vc), avanzamento (f) e profondità di taglio (ap). Fare riferimento alla nostra App Machining Calculator per ulteriori calcoli.

Codice prodotto	RE	P			M			K			N			S			H		
		vc	f	ap	vc	f	ap	vc	f	ap	vc	f	ap	vc	f	ap	vc	f	ap
	(mm)	(m/min)	(mm/rev)	(mm)	(m/min)	(mm/rev)	(mm)	(m/min)	(mm/rev)	(mm)	(m/min)	(mm/rev)	(mm)	(m/min)	(mm/rev)	(mm)	(m/min)	(mm/rev)	(mm)

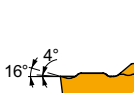

MM geometria a testa sferica per operazioni di copiatura e tornitura longitudinale, da taglio continuo a interrotto.

GL2-D200MM0-MM	G8330	1.0	■	250	0.10	1.0	■	150	0.09	1.0	■	235	0.10	1.0	–	–	–	■	60	0.08	0.8	–	–	–
	T7325	1.0	■	285	0.10	1.0	■	220	0.09	1.0	–	–	–	–	–	–	–	■	90	0.08	0.8	–	–	–



Idoneità e valori iniziali per velocità di taglio (Vc), avanzamento (f) e profondità di taglio (ap). Fare riferimento alla nostra App Machining Calculator per ulteriori calcoli.

Codice prodotto	RE (mm)	P			M			K			N			S			H		
		vc (m/min)	f (mm/rev)	ap (mm)	vc (m/min)	f (mm/rev)	ap (mm)	vc (m/min)	f (mm/rev)	ap (mm)	vc (m/min)	f (mm/rev)	ap (mm)	vc (m/min)	f (mm/rev)	ap (mm)	vc (m/min)	f (mm/rev)	ap (mm)



MM geometria a testa sferica per operazioni di copiatura e tornitura longitudinale, da taglio continuo a interrotto.

GL3-D300MM0-MM	G8330	1.5	210	0.20	1.2	125	0.18	1.2	195	0.20	1.2	-	-	-	50	0.14	1.0	-	-	-
	T7325	1.5	240	0.20	1.2	185	0.18	1.2	-	-	-	-	-	-	75	0.14	1.0	-	-	-
GL4-D400MM0-MM	G8330	2.0	220	0.20	1.2	130	0.18	1.2	205	0.20	1.2	-	-	-	55	0.14	1.0	-	-	-
	T7325	2.0	250	0.20	1.2	195	0.18	1.2	-	-	-	-	-	-	80	0.14	1.0	-	-	-
GL5-D500MM0-MM	G8330	2.5	205	0.25	1.2	120	0.23	1.2	190	0.25	1.2	-	-	-	50	0.18	1.0	-	-	-
	T7325	2.5	235	0.25	1.2	180	0.23	1.2	-	-	-	-	-	-	75	0.18	1.0	-	-	-
GL6-D600MM0-MM	G8330	3.0	195	0.30	1.2	115	0.27	1.2	185	0.30	1.2	-	-	-	45	0.21	1.0	-	-	-
	T7325	3.0	220	0.30	1.2	170	0.27	1.2	-	-	-	-	-	-	70	0.21	1.0	-	-	-

NEW

GL. D - PM



	CW (mm)	CWTOLL (mm)	CWTOLU (mm)	INSL (mm)
200	2.00	-0.05	0.05	25.0
250	2.55	-0.05	0.05	25.0
300	3.00	-0.05	0.05	25.0
400	4.00	-0.05	0.05	25.0
500	5.00	-0.05	0.05	25.0
600	6.00	-0.05	0.05	25.0

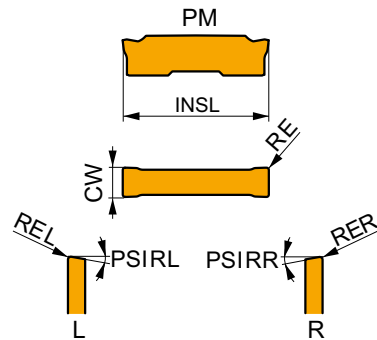

Idoneità e valori iniziali per velocità di taglio (Vc) e avanzamento (f). Fare riferimento alla nostra App Machining Calculator per ulteriori calcoli.

Codice prodotto	RE (mm)	P		M		K		N		S		H		PSIRR (°)	PSIRL (°)
		vc (m/min)	f (mm/rev)	vc (m/min)	f (mm/rev)	vc (m/min)	f (mm/rev)	vc (m/min)	f (mm/rev)	vc (m/min)	f (mm/rev)	vc (m/min)	f (mm/rev)		

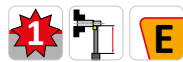
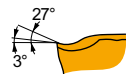

PM geometria primaria per operazioni di tronatura e scanalatura, da taglio continuo a leggermente interrotto.

GL2-D200M02-PM	G8330	0.2	130	0.08	75	0.07	120	0.08	-	-	30	0.06	-	-	-
	T7325	0.2	150	0.08	115	0.07	-	-	-	-	45	0.06	-	-	-
GL3-D250G02-PM	G8330	0.2	130	0.10	75	0.09	120	0.10	-	-	30	0.07	-	-	-
	G8330	0.2	130	0.10	75	0.09	120	0.10	-	-	30	0.07	-	-	-
GL3-D300M02-PM	G8330	0.2	130	0.10	75	0.09	120	0.10	-	-	30	0.07	-	-	-
	T7325	0.2	150	0.10	115	0.09	-	-	-	-	45	0.07	-	-	-
GL4-D400M02-PM	G8330	0.2	130	0.12	75	0.11	120	0.12	-	-	30	0.10	-	-	-
	T7325	0.2	150	0.12	115	0.11	-	-	-	-	45	0.10	-	-	-
GL5-D500M03-PM	G8330	0.3	130	0.15	75	0.14	120	0.15	-	-	30	0.12	-	-	-
GL6-D600M03-PM	G8330	0.3	130	0.15	75	0.14	120	0.15	-	-	30	0.12	-	-	-

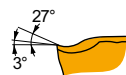

R-PM geometria destra, scelta primaria per la tronatura, da taglio continuo a leggermente interrotto.

GL2-D200G02R06-PM	G8330	0.2	130	0.08	75	0.07	120	0.08	-	-	30	0.06	-	-	6
	T7325	0.2	150	0.08	115	0.07	-	-	-	-	45	0.06	-	-	6
GL2-D200G02R12-PM	G8330	0.2	130	0.08	75	0.07	120	0.08	-	-	30	0.06	-	-	12
	G8330	0.2	130	0.10	75	0.09	120	0.10	-	-	30	0.07	-	-	6
GL3-D300G02R06-PM	G8330	0.2	130	0.10	75	0.09	120	0.10	-	-	30	0.07	-	-	6
	T7325	0.2	150	0.10	115	0.09	-	-	-	-	45	0.07	-	-	6
GL3-D300G02R12-PM	G8330	0.2	130	0.10	75	0.09	120	0.10	-	-	30	0.07	-	-	12
	G8330	0.2	130	0.10	75	0.09	120	0.10	-	-	30	0.07	-	-	12
GL4-D400G02R06-PM	G8330	0.2	130	0.12	75	0.11	120	0.12	-	-	30	0.10	-	-	6
	T7325	0.2	150	0.12	115	0.11	-	-	-	-	45	0.10	-	-	6
GL4-D400G02R12-PM	G8330	0.2	130	0.12	75	0.11	120	0.12	-	-	30	0.10	-	-	12
	G8330	0.2	130	0.12	75	0.11	120	0.12	-	-	30	0.10	-	-	12



Ideoneità e valori iniziali per velocità di taglio (Vc) e avanzamento (f). Fare riferimento alla nostra App Machining Calculator per ulteriori calcoli.

Codice prodotto	RE (mm)	P		M		K		N		S		H		PSIRR (°)	PSIRL (°)
		vc (m/min)	f (mm/rev)	vc (m/min)	f (mm/rev)	vc (m/min)	f (mm/rev)	vc (m/min)	f (mm/rev)	vc (m/min)	f (mm/rev)	vc (m/min)	f (mm/rev)		

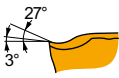

L-PM geometria sinistra, scelta primaria per operazioni di troncatura, da taglio continuo a leggermente interrotto.

GL2-D200G02L06-PM	G8330	0.2	130	0.08	75	0.07	120	0.08	-	-	30	0.06	-	-	6
	T7325	0.2	150	0.08	115	0.07	-	-	-	-	45	0.06	-	-	6
GL2-D200G02L12-PM	G8330	0.2	130	0.08	75	0.07	120	0.08	-	-	30	0.06	-	-	12
	G8330	0.2	130	0.10	75	0.09	120	0.10	-	-	30	0.07	-	-	6
GL3-D300G02L06-PM	G8330	0.2	130	0.10	75	0.09	120	0.10	-	-	30	0.07	-	-	6
	T7325	0.2	150	0.10	115	0.09	-	-	-	-	45	0.07	-	-	6
GL3-D300G02L12-PM	G8330	0.2	130	0.10	75	0.09	120	0.10	-	-	30	0.07	-	-	12
GL4-D400G02L06-PM	G8330	0.2	130	0.12	75	0.11	120	0.12	-	-	30	0.10	-	-	6
	T7325	0.2	150	0.12	115	0.11	-	-	-	-	45	0.10	-	-	6
GL4-D400G02L12-PM	G8330	0.2	130	0.12	75	0.11	120	0.12	-	-	30	0.10	-	-	12

NEW

GL. D - PR

PRAMET

	CW (mm)	CWTOLL (mm)	CWTOLU (mm)	INSL (mm)
200	2.00	-0.05	0.05	25.0
300	3.00	-0.05	0.05	25.0
400	4.00	-0.05	0.05	25.0
500	5.00	-0.05	0.05	25.0
600	6.00	-0.05	0.05	25.0

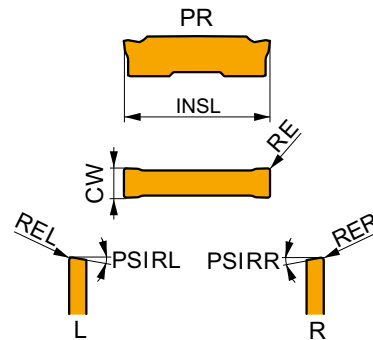

Ideoneità e valori iniziali per velocità di taglio (Vc) e avanzamento (f). Fare riferimento alla nostra App Machining Calculator per ulteriori calcoli.

Codice prodotto	RE (mm)	P		M		K		N		S		H		PSIRR (°)	PSIRL (°)
		vc (m/min)	f (mm/rev)	vc (m/min)	f (mm/rev)	vc (m/min)	f (mm/rev)	vc (m/min)	f (mm/rev)	vc (m/min)	f (mm/rev)	vc (m/min)	f (mm/rev)		

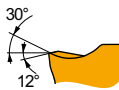

PR geometria primaria per operazioni di troncatura e scanalatura, da taglio continuo a interrotto.

GL2-D200M02-PR	G8330	0.2	130	0.10	75	0.09	120	0.10	-	-	-	-	-	-	-
	T7325	0.2	150	0.10	115	0.09	-	-	-	-	-	-	-	-	-
GL3-D300M02-PR	G8330	0.2	130	0.12	75	0.11	120	0.12	-	-	-	-	-	-	-
	T7325	0.2	150	0.12	115	0.11	-	-	-	-	-	-	-	-	-
GL4-D400M02-PR	G8330	0.2	130	0.15	75	0.14	120	0.15	-	-	-	-	-	-	-
	T7325	0.2	150	0.15	115	0.14	-	-	-	-	-	-	-	-	-
GL5-D500M04-PR	G8330	0.4	130	0.18	75	0.16	120	0.18	-	-	-	-	-	-	-
GL6-D600M04-PR	G8330	0.4	130	0.18	75	0.16	120	0.18	-	-	-	-	-	-	-

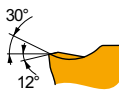

R-PR geometria destra, scelta primaria per la troncatura, da taglio continuo a interrotto.

GL2-D200G02R06-PR	G8330	0.2	130	0.10	75	0.09	120	0.10	-	-	-	-	6	-
GL2-D200G02R12-PR	G8330	0.2	130	0.10	75	0.09	120	0.10	-	-	-	-	12	-
GL3-D300G02R06-PR	G8330	0.2	130	0.12	75	0.11	120	0.12	-	-	-	-	6	-
GL3-D300G02R12-PR	G8330	0.2	130	0.12	75	0.11	120	0.12	-	-	-	-	12	-
GL4-D400G02R06-PR	G8330	0.2	130	0.15	75	0.14	120	0.15	-	-	-	-	6	-
GL4-D400G02R12-PR	G8330	0.2	130	0.15	75	0.14	120	0.15	-	-	-	-	12	-



Idoneità e valori iniziali per velocità di taglio (Vc) e avanzamento (f). Fare riferimento alla nostra App Machining Calculator per ulteriori calcoli.

Codice prodotto		RE (mm)	P		M		K		N		S		H		PSIRR (°)	PSIRL (°)
			vc	f	vc	f	vc	f	vc	f	vc	f	vc	f		
			(m/min)	(mm/rev)	(m/min)	(mm/rev)	(m/min)	(mm/rev)	(m/min)	(mm/rev)	(m/min)	(mm/rev)	(m/min)	(mm/rev)		

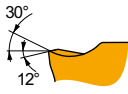

L-PR geometria sinistra, scelta primaria per operazioni di troncatura, da taglio continuo a interrotto.

GL2-D200G02L06-PR	G8330	0.2	■	130	0.10	▣	75	0.09	■	120	0.10	—	—	—	—	—	6
GL2-D200G02L12-PR	G8330	0.2	■	130	0.10	▣	75	0.09	■	120	0.10	—	—	—	—	—	12
GL3-D300G02L06-PR	G8330	0.2	■	130	0.12	▣	75	0.11	■	120	0.12	—	—	—	—	—	6
GL3-D300G02L12-PR	G8330	0.2	■	130	0.12	▣	75	0.11	■	120	0.12	—	—	—	—	—	12
GL4-D400G02L06-PR	G8330	0.2	■	130	0.15	▣	75	0.14	■	120	0.15	—	—	—	—	—	6
GL4-D400G02L12-PR	G8330	0.2	■	130	0.15	▣	75	0.14	■	120	0.15	—	—	—	—	—	12

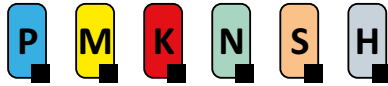
NEW**GLSF(RL) EXT**

PRAMET

G

**Utensile esterno per scanalatura e troncatura, staffa di bloccaggio a V, per inserti GL**

Utensile esterno destro / sinistro per scanalatura con inserti bi-taglienti GL 2, 3, 4, 5 o 6. Adatto per scanalatura esterna e troncatura, fino a una profondità di taglio massima di 32 mm. Disponibile con dimensioni stelo 20x20 o 25x25 mm. Design del corpo rinforzato per una maggiore durata dell'utensile e basse vibrazioni.

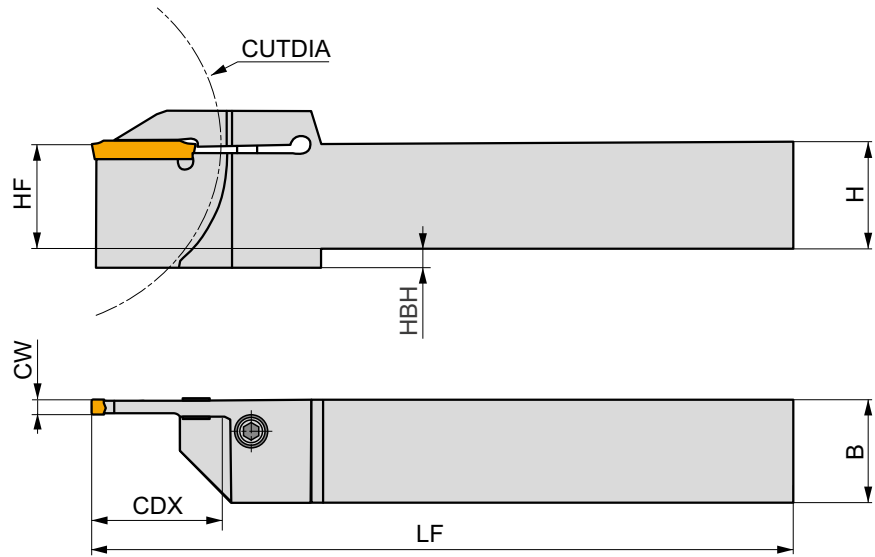
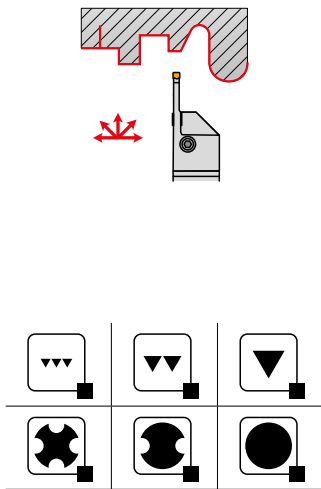

Codice prodotto	HF	HBH	H	B	LF	CW	CDX	CUTDIA	kg	G334	GL11
	(mm)	(mm)	(mm)	(mm)	(mm)	(mm)	(mm)	(mm)			
R GL2-S2020KFR-20-80	20	-	20	20	125	2.00	20	80	0.38	G1334	GL11
GL2-S2020KFR-24-80	20	5	20	20	125	2.00	24	80	0.36	G1334	GL11
GL2-S2525MFR-20-80	25	-	25	25	150	2.00	20	80	0.68	G1334	GL11
GL2-S2525MFR-24-80	25	-	25	25	150	2.00	24	80	0.64	G1334	GL11
GL3-S2020KFR-20-80	20	-	20	20	125	3.00	20	80	0.38	G1335	GL11
GL3-S2020KFR-24-80	20	5	20	20	125	3.00	24	80	0.36	G1335	GL11
GL3-S2525MFR-20-80	25	-	25	25	150	3.00	20	80	0.68	G1335	GL11
GL3-S2525MFR-24-80	25	-	25	25	150	3.00	24	80	0.65	G1335	GL11
GL3-S2525PFR-32-80	25	5	25	25	170	3.00	32	80	0.72	G1335	GL11
GL4-S2020KFR-20-80	20	-	20	20	125	4.00	20	80	0.38	G1336	GL11
GL4-S2020KFR-24-80	20	5	20	20	125	4.00	24	80	0.37	G1336	GL11
GL4-S2525MFR-20-80	25	-	25	25	150	4.00	20	80	0.68	G1336	GL11
GL4-S2525MFR-24-80	25	-	25	25	150	4.00	24	80	0.65	G1336	GL11
GL4-S2525PFR-32-80	25	5	25	25	170	4.00	32	80	0.78	G1336	GL11
GL5-S2020KFR-20-80	20	-	20	20	125	5.00	20	80	0.38	G1337	GL11
GL5-S2525MFR-20-80	25	-	25	25	150	5.00	20	80	0.68	G1337	GL11
GL5-S2525PFR-32-100	25	5	25	25	170	5.00	32	100	0.75	G1337	GL11
GL6-S2020KFR-20-80	20	-	20	20	125	6.00	20	80	0.39	G1338	GL11
GL6-S2525MFR-20-80	25	-	25	25	150	6.00	20	80	0.68	G1338	GL11
GL6-S2525PFR-32-100	25	5	25	25	170	6.00	32	100	0.75	G1338	GL11
L GL2-S2020KFL-20-80	20	-	20	20	125	2.00	20	80	0.38	G1334	GL11
GL2-S2020KFL-24-80	20	5	20	20	125	2.00	24	80	0.36	G1334	GL11
GL2-S2525MFL-20-80	25	-	25	25	150	2.00	20	80	0.70	G1334	GL11
GL2-S2525MFL-24-80	25	-	25	25	150	2.00	24	80	0.64	G1334	GL11
GL3-S2020KFL-20-80	20	-	20	20	125	3.00	20	80	0.38	G1335	GL11
GL3-S2020KFL-24-80	20	5	20	20	125	3.00	24	80	0.36	G1335	GL11
GL3-S2525MFL-20-80	25	-	25	25	150	3.00	20	80	0.68	G1335	GL11



Codice prodotto	HF	HBH	H	B	LF	CW	CDX	CUTDIA			
	(mm)	(mm)	(mm)	(mm)	(mm)	(mm)	(mm)	(mm)			
GL3-S2525MFL-24-80	25	–	25	25	150	3.00	24	80	0.65	GI335	GL11
GL3-S2525PFL-32-80	25	5	25	25	170	3.00	32	80	0.78	GI335	GL11
GL4-S2020KFL-20-80	20	–	20	20	125	4.00	20	80	0.38	GI336	GL11
GL4-S2020KFL-24-80	20	5	20	20	125	4.00	24	80	0.37	GI336	GL11
GL4-S2525MFL-20-80	25	–	25	25	150	4.00	20	80	0.68	GI336	GL11
GL4-S2525MFL-24-80	25	–	25	25	150	4.00	24	80	0.65	GI336	GL11
GL4-S2525PFL-32-80	25	5	25	25	170	4.00	32	80	0.72	GI336	GL11
GL5-S2020KFL-20-80	20	–	20	20	125	5.00	20	80	0.38	GI337	GL11
GL5-S2525MFL-20-80	25	–	25	25	150	5.00	20	80	0.71	GI337	GL11
GL5-S2525PFL-32-100	25	5	25	25	170	5.00	32	100	0.75	GI337	GL11
GL6-S2020KFL-20-80	20	–	20	20	125	6.00	20	80	0.39	GI338	GL11
GL6-S2525MFL-20-80	25	–	25	25	150	6.00	20	80	0.71	GI338	GL11
GL6-S2525PFL-32-100	25	5	25	25	170	6.00	32	100	0.75	GI338	GL11

L

GI334	GL2..
GI335	GL3..
GI336	GL4..
GI337	GL5..
GI338	GL6..

GL11	US 5018-T20P	5.0	M 5	18.2	LK T20P

Profondità di taglio su diametro lavorato a pagina 416.

NEW

GLSF(RL) EXT-G



PRAMET

G

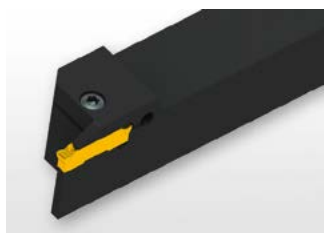

Utensile esterno per scanalatura e tornitura, staffa di bloccaggio a V, per inserti GL

Utensile esterno destro / sinistro per scanalatura con inserti bi-taglienti GL 2, 3, 4, 5 o 6. Adatto per applicazioni di scanalatura esterna, tornitura longitudinale e profilatura, fino ad una profondità di taglio massima di 12 mm. Disponibile con dimensioni stelo 20x20 o 25x25 mm. Corpo trattato per una maggiore durata dell'utensile.

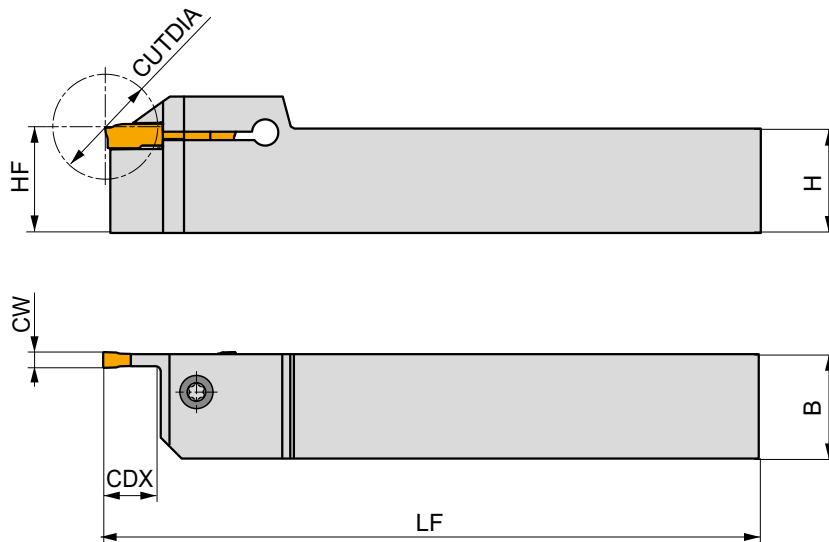
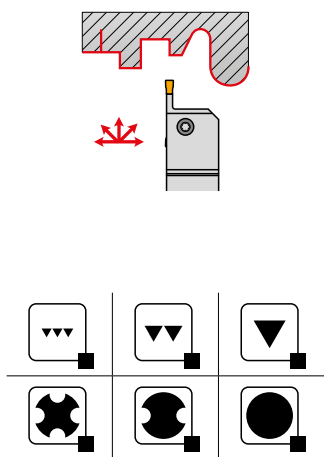

Codice prodotto	≡	H	B	L	CW	CDX	CUTDIA	kg				
	(mm)	(mm)	(mm)	(mm)	(mm)	(mm)	(mm)					
R	GL2-S2020KFR-10	20	20	20	125	2.00	10	20	0.38	GI334	GL11	
	GL2-S2525MFR-10	25	25	25	150	2.00	10	20	0.69	GI334	GL11	
	GL3-S2020KFR-10	20	20	20	125	3.00	10	20	0.36	GI335	GL11	
	GL3-S2525MFR-10	25	25	25	150	3.00	10	20	0.69	GI335	GL11	
	GL4-S2020KFR-12	20	20	20	125	4.00	12	24	0.37	GI336	GL11	
	GL4-S2525MFR-12	25	25	25	150	4.00	12	24	0.69	GI336	GL11	
	GL5-S2020KFR-12	20	20	20	125	5.00	12	24	0.36	GI337	GL11	
	GL5-S2525MFR-12	25	25	25	150	5.00	12	24	0.70	GI337	GL11	
	GL6-S2020KFR-12	20	20	20	125	6.00	12	24	0.36	GI338	GL11	
	GL6-S2525MFR-12	25	25	25	150	6.00	12	24	0.68	GI338	GL11	
	L	GL2-S2020KFL-10	20	20	20	125	2.00	10	20	0.37	GI334	GL11
		GL2-S2525MFL-10	25	25	25	150	2.00	10	20	0.70	GI334	GL11
GL3-S2020KFL-10		20	20	20	125	3.00	10	20	0.36	GI335	GL11	
GL3-S2525MFL-10		25	25	25	150	3.00	10	20	0.70	GI335	GL11	
GL4-S2020KFL-12		20	20	20	125	4.00	12	24	0.37	GI336	GL11	
GL4-S2525MFL-12		25	25	25	150	4.00	12	24	0.69	GI336	GL11	
GL5-S2020KFL-12		20	20	20	125	5.00	12	24	0.36	GI337	GL11	
GL5-S2525MFL-12		25	25	25	150	5.00	12	24	0.69	GI337	GL11	
GL6-S2020KFL-12		20	20	20	125	6.00	12	24	0.36	GI338	GL11	
GL6-S2525MFL-12		25	25	25	150	6.00	12	24	0.68	GI338	GL11	

GI334	GL2..
GI335	GL3..
GI336	GL4..
GI337	GL5..
GI338	GL6..

GL11	US 5018-T20P	5.0	M 5	18.2	LKT20P

NEW**GLSF(RL) EXT-S**

PRAMET

G

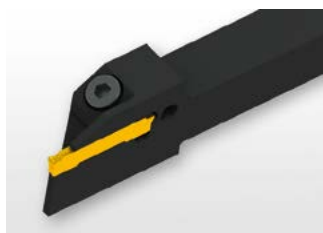
**Utensile esterno per scanalatura e taglio, per inserti GL, macchine a fantina mobile**

Utensile per scanalatura esterno destro / sinistro, per macchine a fantina mobile con inserti GL 2, 3, 4. Per applicazioni di scanalatura esterna, profilatura e troncatura fino a una profondità di taglio massima di 16 mm. Disponibile con dimensioni stelo 12x12 o 16x16 mm. Design del corpo rinforzato per una maggiore durata dell'utensile e basse vibrazioni, bloccaggio di facile accesso.

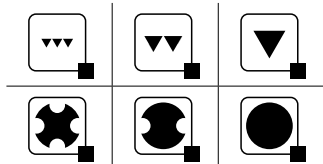
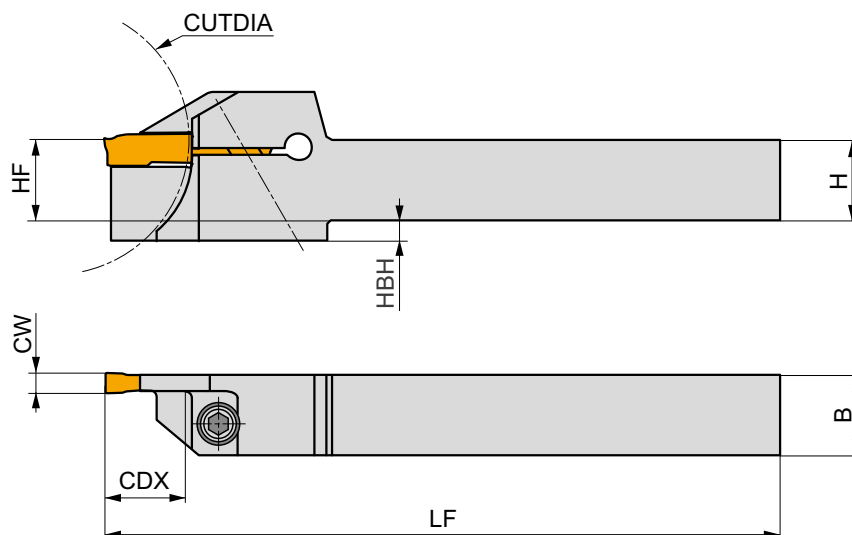
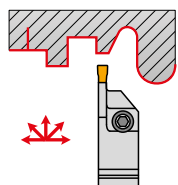

Codice prodotto	HF	HBH	H	B	LF	CW	CDX	CUTDIA	kg	Icona 1	Icona 2	
	(mm)	(mm)	(mm)	(mm)	(mm)	(mm)	(mm)	(mm)				
R	GL2-S1212HFR-12-40	12	3	12	12	100	2.00	12	40	0.11	GI334	GL13
	GL2-S1616KFR-16-45	16	3	16	16	125	2.00	16	45	0.23	GI334	GL12
	GL3-S1212HFR-12-40	12	3	12	12	100	3.00	12	40	0.11	GI335	GL13
	GL3-S1616KFR-16-45	16	3	16	16	125	3.00	16	45	0.23	GI335	GL12
	GL4-S1616KFR-16-45	16	4	16	16	125	4.00	16	45	0.26	GI336	GL12
L	GL2-S1212HFL-12-40	12	3	12	12	100	2.00	12	40	0.11	GI334	GL13
	GL2-S1616KFL-16-45	16	3	16	16	125	2.00	16	45	0.23	GI334	GL12
	GL3-S1212HFL-12-40	12	3	12	12	100	3.00	12	40	0.11	GI335	GL13
	GL3-S1616KFL-16-45	16	3	16	16	125	3.00	16	45	0.23	GI335	GL12
	GL4-S1616KFL-16-45	16	4	16	16	125	4.00	16	45	0.24	GI336	GL12

Icona 1	Icona 2
GI334	GL2..
GI335	GL3..
GI336	GL4..

Icona 1	Icona 2	Icona 3	Icona 4	Icona 5	Icona 6
GL12	HS 0516	5.0	M 5	16	HXK 4
GL13	HS 0412	5.0	M 4	12	HXK 3

Profondità di taglio su diametro lavorato a pagina 416.

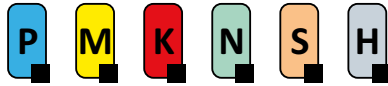
NEW**GLS B**

PRAMET

X**Lama da troncatura a doppio lato per inserti GL**

Lama per applicazioni di troncatura fino a una profondità massima di 60 mm o barra Ø120 mm. Adatta per inserti bi-taglienti della famiglia GL. Disponibile in altezza da 26 e 32 mm. Può essere alloggiata nei supporti base DU Pramet. Lama trattata per una maggiore durata.

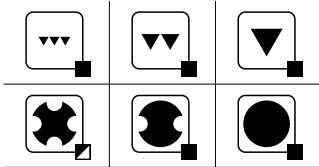
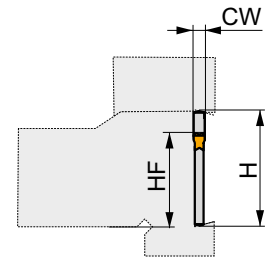
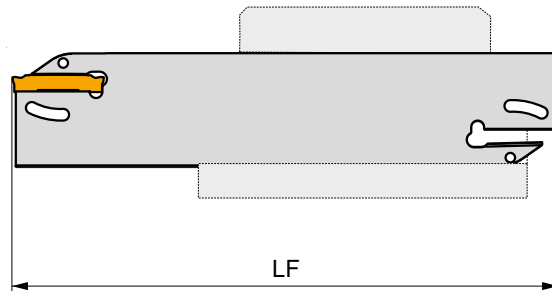
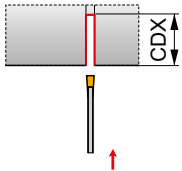

Codice prodotto	≡ (mm)	H (mm)	LF (mm)	CW (mm)	CDX (mm)	kg		
GL2-S26KB	21.4	26	125	2.00	35	0.13	GI334	KV2
GL2-S32MB	25	32	150	2.00	50	0.15	GI334	KV2
GL3-S26KB	21.4	26	125	3.00	35	0.15	GI335	KV2
GL3-S32MB	25	32	150	3.00	50	0.16	GI335	KV2
GL4-S32MB	25	32	150	4.00	50	0.16	GI336	KV2
GL5-S32MB	25	32	150	5.00	60	0.16	GI337	KV2
GL6-S32MB	25	32	150	6.00	60	0.16	GI338	KV2

GI334	GL2..
GI335	GL3..
GI336	GL4..
GI337	GL5..
GI338	GL6..

KV2	KV 15x150

**DU, D****Blocco porta lama per lame di troncatura**

Portautensile per adattare lame di troncatura GL o XLC. Disponibile nelle dimensioni 20x20 fino a 40x40 mm. Corpi trattati per una maggiore durata.

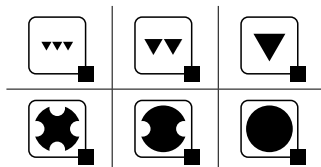
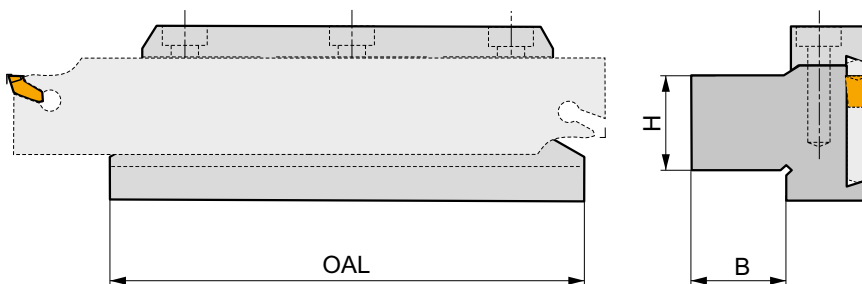
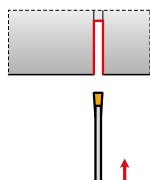

Codice prodotto	H (mm)	B (mm)	OAL (mm)	kg		
26-DU 2020	20	20	90	0.70	GI007	ND2
26-D 2020	20	20	100	0.82	GI007	ND2
32-DU 2523	25	23	110	1.02	GI008	ND2
32-DU 2532	25	32	110	1.10	GI008	ND2
32-DU 3229	32	29	110	1.25	GI008	ND2
32-D 2530	25	30	115	1.30	GI008	ND2
45-DU 3229	32	29	110	1.50	GI009	ND7
45-DU 4036	40	36	110	2.05	GI009	ND7
47-D 4040	40	40	150	3.88	GI091	ND3

GI007	XLC.N 26..	GL.-S26.B
GI008	XLC.N 32..	GL.-S32.B
GI009	XLC.N 45..	-
GI091	XLC.N 47..	-

ND2	HS 0625	6.0	M 6	25	HXK 5
ND3	HS 1030	8.0	M 10	30	HXK 8
ND7	HS 0630	6.0	M 6	30	HXK 5



PROFONDITÀ DI TAGLIO IN BASE AL DIAMETRO LAVORATO

GLSF (RL) EXT

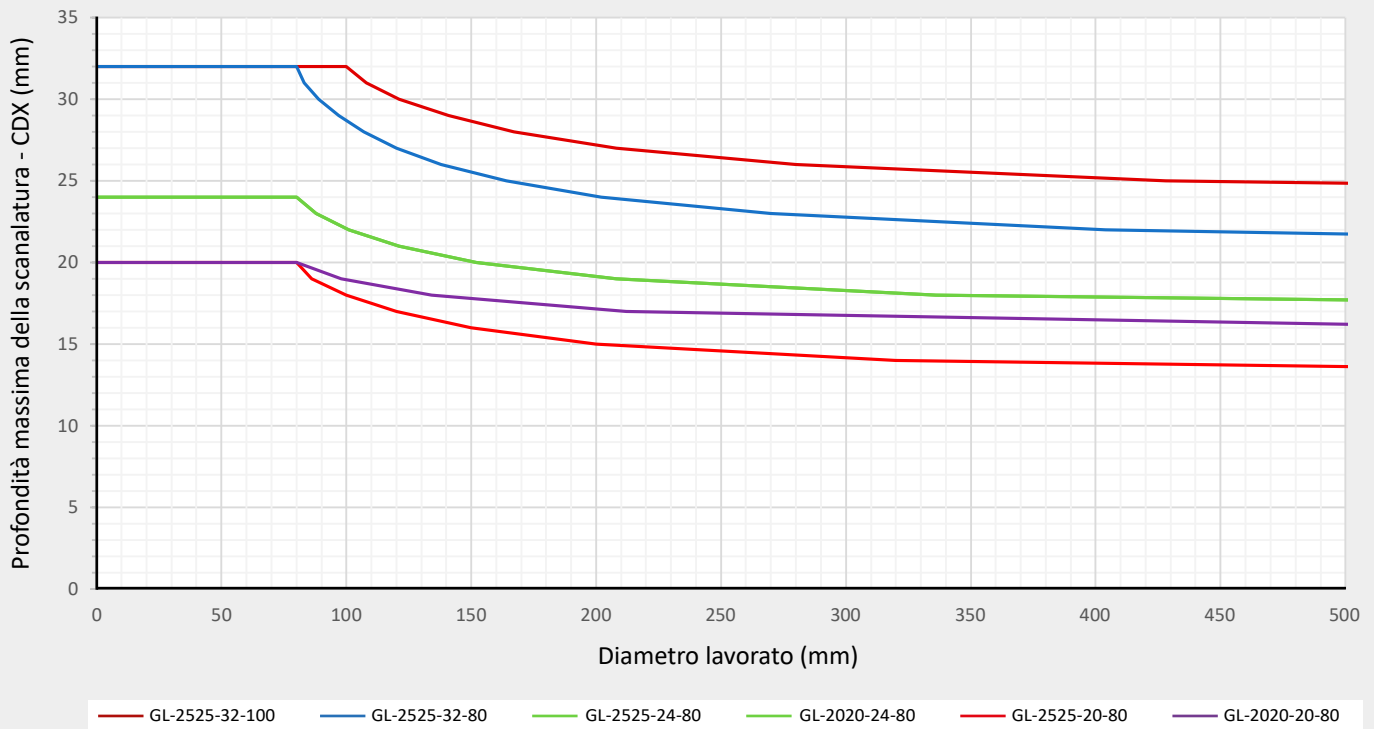

GLSF (RL) EXT-S

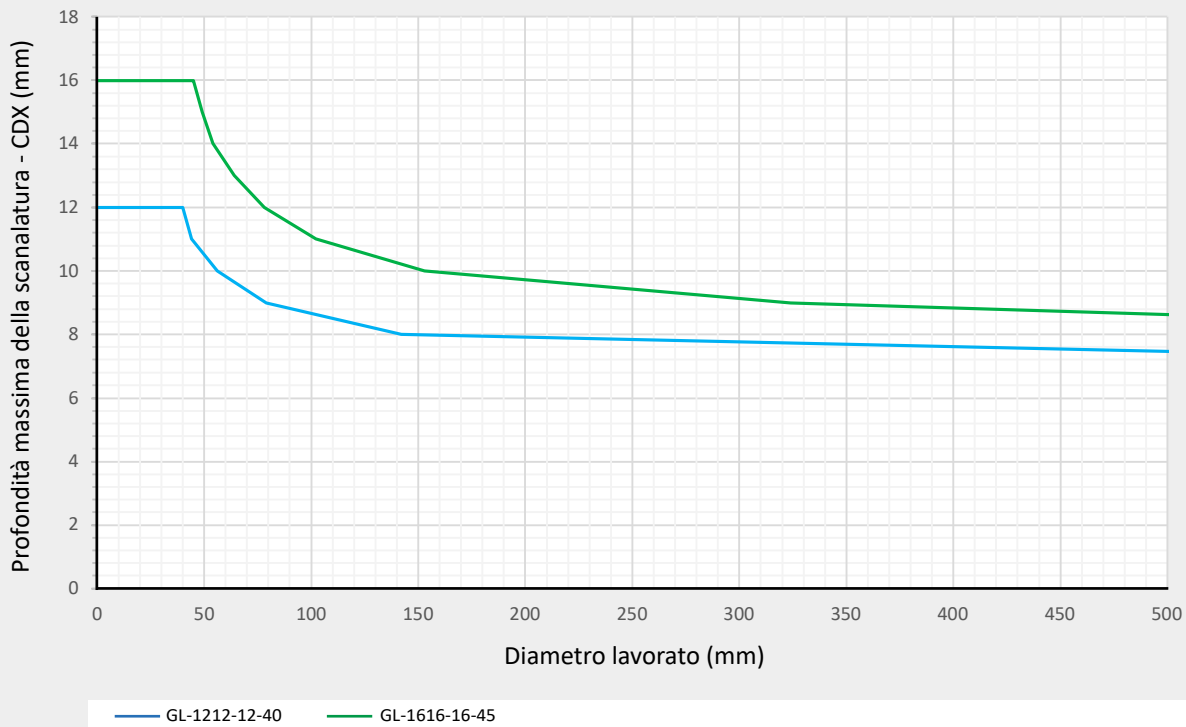



PROFONDITÀ DI TAGLIO IN BASE AL DIAMETRO LAVORATO

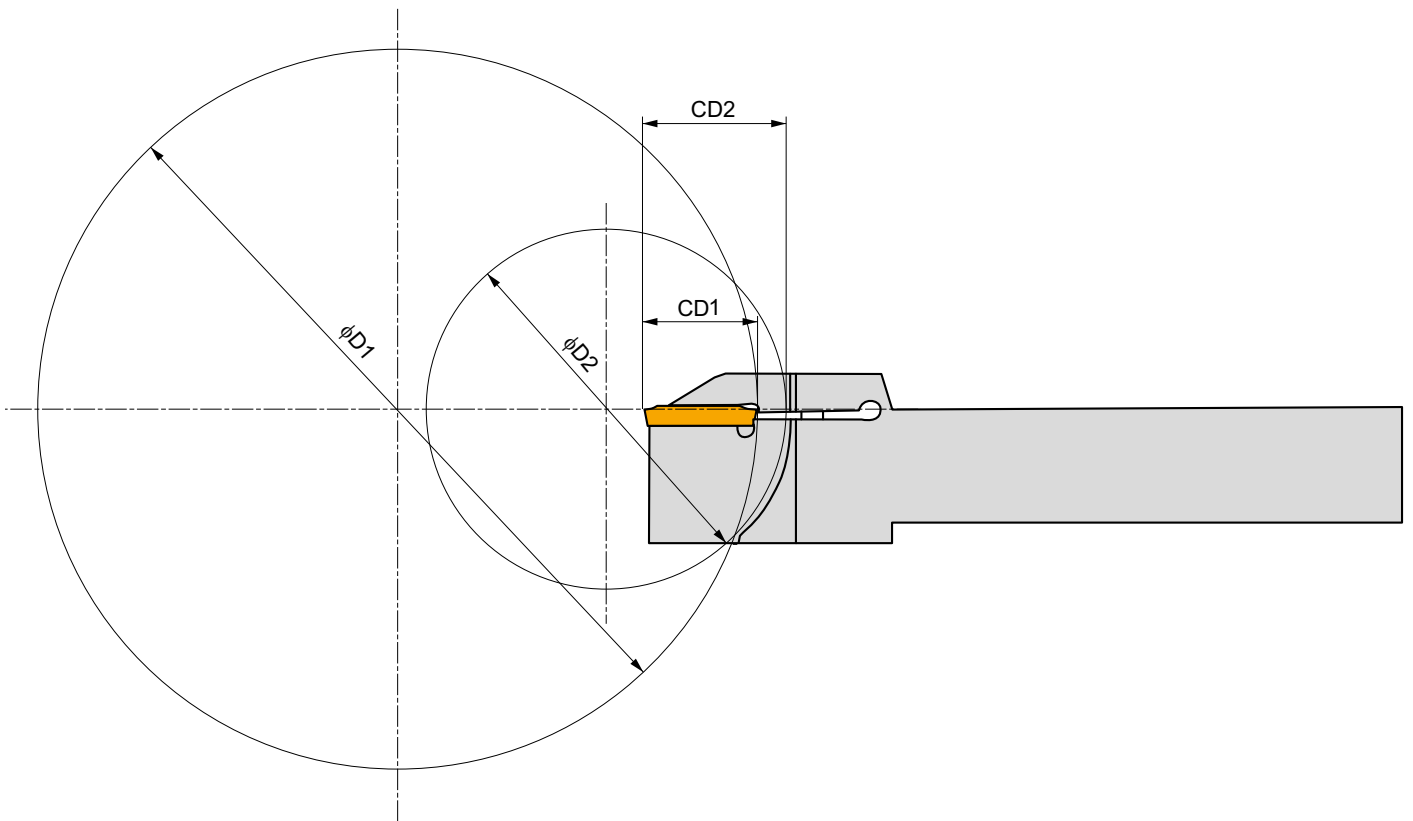



LCMF 13 - CM

PRAMET

	CW	CWTOLL	CWTOLU	INSL
	(mm)	(mm)	(mm)	(mm)
0313	3.00	-0.05	0.05	12.6
0413	4.00	-0.05	0.05	12.6

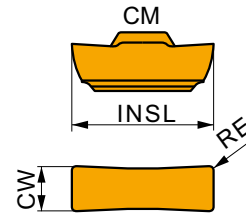

Idoneità e valori iniziali per velocità di taglio (Vc) e avanzamento (f). Fare riferimento alla nostra App Machining Calculator per ulteriori calcoli.

Codice prodotto	RE	P		M		K		N		S		H		PSIRR	PSIRL
		vc	f	vc	f	vc	f	vc	f	vc	f	(°)	(°)		
	(mm)	(m/min)	(mm/rev)	(m/min)	(mm/rev)	(m/min)	(mm/rev)	(m/min)	(mm/rev)	(m/min)	(mm/rev)	(m/min)	(mm/rev)		

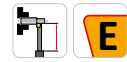
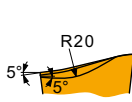

CM geometria primaria per operazioni di scanalatura.

LCMF 031304-CM	T8330	0.4	130	0.11	75	0.10	120	0.11	-	-	-	-	-	-	-
LCMF 031304-CM-04	T8330 ¹⁾	0.4	130	0.11	75	0.10	120	0.11	-	-	-	-	-	-	-
LCMF 041304-CM	T8330	0.4	130	0.11	75	0.10	120	0.11	-	-	-	-	-	-	-

¹⁾ Insetto per utensili interni A16Q-GGERILO313-04, A20R-GGFRILO313-04.

LCMF 13 - F

PRAMET

	CW	CWTOLL	CWTOLU	INSL
	(mm)	(mm)	(mm)	(mm)
0313	3.00	-0.05	0.05	12.6
0413	4.00	-0.05	0.05	12.6

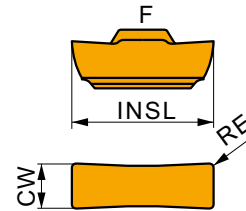

Idoneità e valori iniziali per velocità di taglio (Vc), avanzamento (f) e profondità di taglio (ap). Fare riferimento alla nostra App Machining Calculator per ulteriori calcoli.

Codice prodotto	RE	P			M			K			N			S			H		
		vc	f	ap	vc	f	ap	vc	f	ap	vc	f	ap	vc	f	ap	vc	f	ap
	(mm)	(m/min)	(mm/rev)	(mm)	(m/min)	(mm/rev)	(mm)	(m/min)	(mm/rev)	(mm)	(m/min)	(mm/rev)	(mm)	(m/min)	(mm/rev)	(mm)	(m/min)	(mm/rev)	(mm)

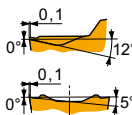

F geometria primaria per la tornitura.

LCMF 031302-F	T8330	0.2	195	0.10	0.3	115	0.09	0.3	185	0.10	0.3	-	-	-	-	-	-	-	-
LCMF 031302-F-04	T8330 ¹⁾	0.2	195	0.10	0.3	115	0.09	0.3	185	0.10	0.3	-	-	-	-	-	-	-	-
LCMF 031304-F	T8330	0.4	185	0.13	0.5	110	0.12	0.5	175	0.13	0.5	-	-	-	-	-	-	-	-
LCMF 031304-F-04	T8330 ¹⁾	0.4	185	0.13	0.5	110	0.12	0.5	175	0.13	0.5	-	-	-	-	-	-	-	-
LCMF 041304-F	T8330	0.4	185	0.13	0.5	110	0.12	0.5	175	0.13	0.5	-	-	-	-	-	-	-	-
	T9325	0.4	275	0.13	0.5	165	0.12	0.5	260	0.13	0.5	-	-	-	-	-	-	-	-

¹⁾ Insetto per utensili interni A16Q-GGERILO313-04, A20R-GGFRILO313-04.



LCMF 13 - MP

	CW	CWTOLL	CWTOLU	INSL
	(mm)	(mm)	(mm)	(mm)
0313	3.00	-0.05	0.05	12.6
0413	4.00	-0.05	0.05	12.6

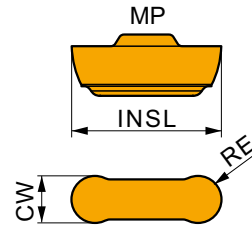

Idoneità e valori iniziali per velocità di taglio (Vc), avanzamento (f) e profondità di taglio (ap). Fare riferimento alla nostra App Machining Calculator per ulteriori calcoli.

Codice prodotto	RE	P			M			K			N			S			H		
		vc	f	ap	vc	f	ap	vc	f	ap	vc	f	ap	vc	f	ap	vc	f	ap
	(mm)	(m/min)	(mm/rev)	(mm)	(m/min)	(mm/rev)	(mm)	(m/min)	(mm/rev)	(mm)	(m/min)	(mm/rev)	(mm)	(m/min)	(mm/rev)	(mm)	(m/min)	(mm/rev)	(mm)

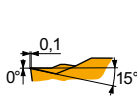

MP geometria per operazioni di tornitura longitudinale e copiatura, per lavorazioni leggere e finitura, da taglio continuo a interrotto.

LCMF 0313MO-MP	T8330	1.5	■	190	0.30	0.8	☑	110	0.27	0.8	■	180	0.30	0.8	■	-	-	-	-	-	-
LCMF 0313MO-MP-04	T8330¹⁾	1.5	■	190	0.30	0.8	☑	110	0.27	0.8	■	180	0.30	0.8	■	-	-	-	-	-	-
LCMF 0413MO-MP	T8330	2.0	■	175	0.40	1.0	☑	105	0.36	1.0	■	165	0.40	1.0	■	-	-	-	-	-	-

¹⁾ Insetto per utensili interni A16Q-GGERILO313-04, A20R-GGFRIL0313-04.

LCMR 13 - F

	CW	CWTOLL	CWTOLU	INSL
	(mm)	(mm)	(mm)	(mm)
0313	3.00	-0.05	0.05	12.6
0413	4.00	-0.05	0.05	12.6

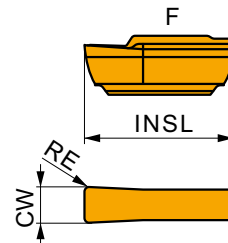

Idoneità e valori iniziali per velocità di taglio (Vc), avanzamento (f) e profondità di taglio (ap). Fare riferimento alla nostra App Machining Calculator per ulteriori calcoli.

Codice prodotto	RE	P			M			K			N			S			H		
		vc	f	ap	vc	f	ap	vc	f	ap	vc	f	ap	vc	f	ap	vc	f	ap
	(mm)	(m/min)	(mm/rev)	(mm)	(m/min)	(mm/rev)	(mm)	(m/min)	(mm/rev)	(mm)	(m/min)	(mm/rev)	(mm)	(m/min)	(mm/rev)	(mm)	(m/min)	(mm/rev)	(mm)

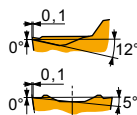

F geometria per operazioni di scanalatura e tornitura, adatto per lavorazioni leggere e finitura, da taglio continuo a leggermente interrotto.

LCMR 031304-F	T8330	0.4	■	185	0.13	0.5	☑	110	0.12	0.5	■	175	0.13	0.5	■	-	-	-	-	-	-
LCMR 041304-F	T8330	0.4	■	185	0.13	0.5	☑	110	0.12	0.5	■	175	0.13	0.5	■	-	-	-	-	-	-



LCMR 13 - MP

	CW	CWTOLL	CWTOLU	INSL
	(mm)	(mm)	(mm)	(mm)
0313	3.00	-0.05	0.05	12.6
0413	4.00	-0.05	0.05	12.6

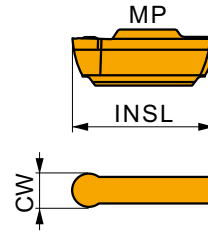

Idoneità e valori iniziali per velocità di taglio (V_c), avanzamento (f) e profondità di taglio (a_p). Fare riferimento alla nostra App Machining Calculator per ulteriori calcoli.

Codice prodotto	RE (mm)	P			M			K			N			S			H		
		v_c (m/min)	f (mm/rev)	a_p (mm)	v_c (m/min)	f (mm/rev)	a_p (mm)	v_c (m/min)	f (mm/rev)	a_p (mm)	v_c (m/min)	f (mm/rev)	a_p (mm)	v_c (m/min)	f (mm/rev)	a_p (mm)	v_c (m/min)	f (mm/rev)	a_p (mm)

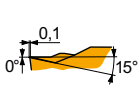

MP geometria per operazioni di tornitura longitudinale e copiatura, da taglio continuo a interrotto.

LCMR 0313MO-MP	T8330	1.5	190	0.30	0.8	110	0.27	0.8	180	0.30	0.8	-	-	-	-	-	-	-
LCMR 0413MO-MP	T8330	2.0	175	0.40	1.0	105	0.36	1.0	165	0.40	1.0	-	-	-	-	-	-	-



GG.(RL) INT

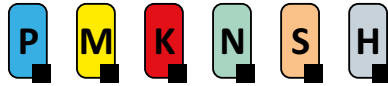

PRAMET

G



Utensile di Scanalatura interna per inserti LCM...

Bareno destro/sinistro per scanalatura interna per inserti LCM...0313 e 0413. Diametro minimo di scanalatura interna Ø16 mm. Adatto per la scanalatura interna e tornitura multidirezionale. Disponibile con dimensioni dello stelo da Ø16 a Ø32 mm. Corpo trattato per una maggiore durata.

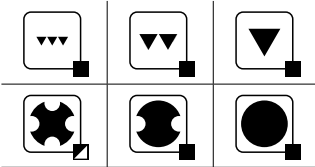
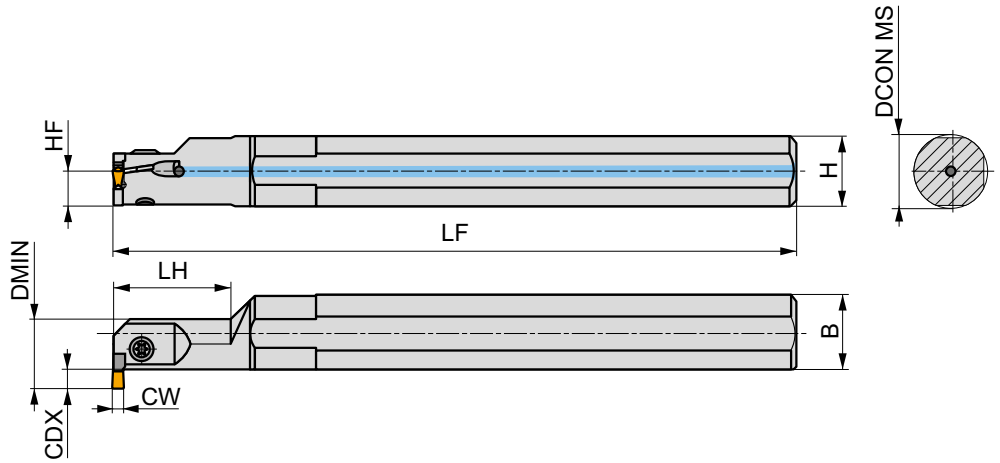
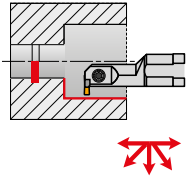

Codice prodotto	DCON MS (mm)	HF (mm)	H (mm)	B (mm)	LF (mm)	LH (mm)	CW (mm)	CDX (mm)	DMIN (mm)		kg		
R A16Q-GGER 0313	16	7.5	15	15.5	180	25	3.00	3	16	✓	0.26	GI143	GL06
A16Q-GGER 0313-04	16	7.5	15	15.5	180	25	3.00	3	16	✓	0.26	GI190	GL06
A20R-GGFR 0313	20	9	18	19	200	30	3.00	4.5	20	✓	0.36	GI143	GL06
A20R-GGFR 0313-04	20	9	18	19	200	30	3.00	4.5	20	✓	0.39	GI190	GL06
A25S-GGHR 0313	25	11.5	23	24	250	40	3.00	6.5	25	✓	0.78	GI143	GL06
A25S-GGFR 0413	25	11.5	23	24	250	40	4.00	6.5	25	✓	0.73	GI170	GL06
A32T-GGHR 0413	32	15	30	31	300	50	4.00	9.5	32	✓	1.59	GI170	GL06
L A16Q-GGEL 0313	16	7.5	15	15.5	180	25	3.00	3	16	✓	0.29	GI143	GL06
A16Q-GGEL 0313-04	16	7.5	15	15.5	180	25	3.00	3	16	✓	0.28	GI190	GL06
A20R-GGFL 0313	20	9	18	19	200	30	3.00	4.5	20	✓	0.38	GI143	GL06
A20R-GGFL 0313-04	20	9	18	19	200	30	3.00	4.5	20	✓	0.38	GI190	GL06
A25S-GGHL 0313	25	11.5	23	24	250	40	3.00	6.5	25	✓	0.81	GI143	GL06
A25S-GGFL 0413	25	11.5	23	24	250	40	4.00	6.5	25	✓	0.82	GI170	GL06
A32T-GGHL 0413	32	15	30	31	300	50	4.00	9.5	32	✓	1.59	GI170	GL06



GI143
GI170
GI190

LCM. 0313..
LCM. 0413..
LCM. 0313.....-04



GL06

SR 85011-T15P

5.0

M 5

9

FLAGT15P



GFIL-L AXIAL

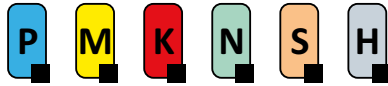

PRAMET

G



Utensile esterno per scanalatura frontale, staffa di bloccaggio a V, per inserti LCM. 03

Utensile esterno sinistro per scanalatura frontale con inserti LCM 0313 o 0316, mono o bi-taglienti. Adatto per applicazioni di scanalatura e profilatura frontale diametri da Ø17 a Ø170 mm con profondità massima di taglio 9 mm. Disponibile con misura stelo 25x25 mm. Corpo trattato per una maggiore durata dell'utensile.

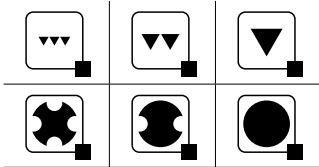
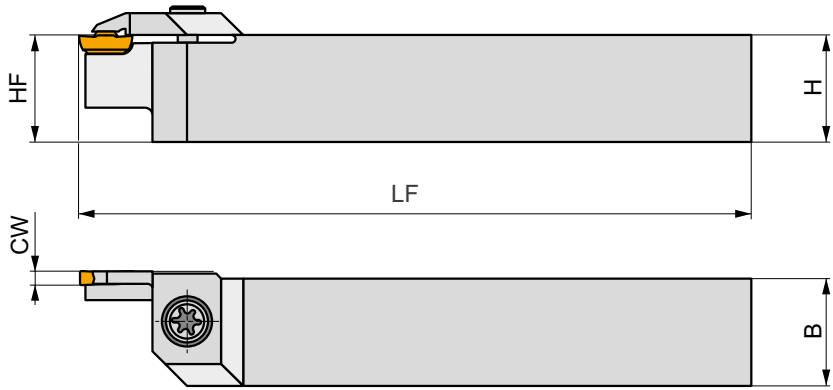
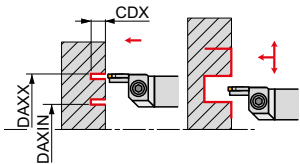

Codice prodotto	HF (mm)	H (mm)	B (mm)	LF (mm)	CW (mm)	CDX (mm)	DAXIN (mm)	DAXX (mm)	kg		
L GFIL 2525 M 0313L 030017	25	25	25	150	3.00	9	17	30	0.64	G1143	GL02
GFIL 2525 M 0313L 039024	25	25	25	150	3.00	9	24	39	0.66	G1143	GL07
GFIL 2525 M 0313L 050033	25	25	25	150	3.00	9	33	50	0.67	G1143	GL07
GFIL 2525 M 0313L 060043	25	25	25	150	3.00	9	43	60	0.67	G1143	GL07
GFIL 2525 M 0313L 076053	25	25	25	150	3.00	9	53	76	0.67	G1143	GL07
GFIL 2525 M 0316L 100070	25	25	25	150	3.00	9	70	100	0.69	G1136	GL07
GFIL 2525 M 0316L 130090	25	25	25	150	3.00	9	90	130	0.70	G1136	GL07
GFIL 2525 M 0316L 170110	25	25	25	150	3.00	9	110	170	0.71	G1136	GL07

G1136	LCM. 0316..
G1143	LCM. 0313..

GL02	US 5015-T20P	5.0	M 5	15	FLAGT20P
GL07	US 5018-T20P	5.0	M 5	18.2	FLAGT20P



GFIL-R AXIAL

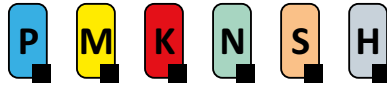

PRAMET

G



Utensile esterno per scanalatura frontale, staffa di bloccaggio a V, per inserti LCM. 03 / 04

Utensile esterno per scanalatura frontale, sinistro, con inserti LCM mono o bi-taglienti, dimensioni 0313, 0316, 0413 o 0416. Adatto per applicazioni di scanalatura e profilatura frontale, diametri da Ø17 a Ø230 mm, con profondità massima di taglio 12 mm. Disponibile con stelo 25x25. Corpo trattato per una maggiore durata dell'utensile.

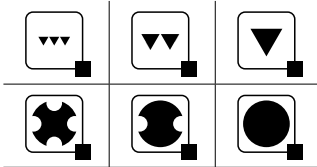
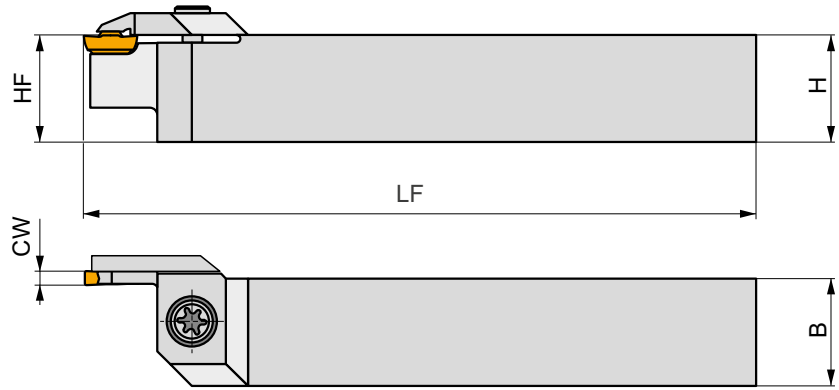
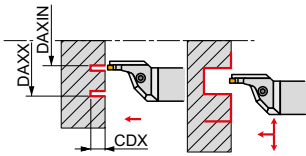

Codice prodotto	HF	H	B	LF	CW	CDX	DAXIN	DAXX	kg		
	(mm)	(mm)	(mm)	(mm)	(mm)	(mm)	(mm)	(mm)			
L GFIL 2525 M 03R 030017-A	25	25	25	150	3.00	9	17	30	0.69	GI143	GL07
GFIL 2525 M 03R 039024-A	25	25	25	150	3.00	9	24	39	0.69	GI143	GL07
GFIL 2525 M 03R 050033-A	25	25	25	150	3.00	9	33	50	0.72	GI143	GL07
GFIL 2525 M 03R 060043-A	25	25	25	150	3.00	9	43	60	0.69	GI143	GL07
GFIL 2525 M 03R 076053-A	25	25	25	150	3.00	9	53	76	0.68	GI143	GL07
GFIL 2525 M 03R 100070-A	25	25	25	150	3.00	9	70	100	0.79	GI136	GL08
GFIL 2525 M 03R 130090-A	25	25	25	150	3.00	9	90	130	0.73	GI136	GL08
GFIL 2525 M 03R 170110-A	25	25	25	150	3.00	9	110	170	0.76	GI136	GL08
GFIL 2525 M 04R 030017-A	25	25	25	150	3.00	9	17	30	0.71	GI170	GL07
GFIL 2525 M 04R 034021-A	25	25	25	150	4.00	9	21	34	0.69	GI170	GL07
GFIL 2525 M 04R 040026-A	25	25	25	150	4.00	11	26	40	0.00	GI170	GL07
GFIL 2525 M 04R 050032-A	25	25	25	150	4.00	11	32	50	0.68	GI170	GL07
GFIL 2525 M 04R 060042-A	25	25	25	150	4.00	11	42	60	0.66	GI170	GL07
GFIL 2525 M 04R 075052-A	25	25	25	150	4.00	11	52	75	0.67	GI170	GL07
GFIL 2525 M 04R 100070-A	25	25	25	150	4.00	12	70	100	0.75	GI137	GL08
GFIL 2525 M 04R 130090-A	25	25	25	150	4.00	12	90	130	0.75	GI137	GL08
GFIL 2525 M 04R 170110-A	25	25	25	150	4.00	12	110	170	0.75	GI137	GL08
GFIL 2525 M 04R 230140-A	25	25	25	150	4.00	12	140	230	0.78	GI137	GL08



GI136
GI137
GI143
GI170

LCM. 0316..
LCM. 0416..
LCM. 0313..
LCM. 0413..



GL07
GL08

US 5018-T20P
US 6020-T25P

5.0
6.0

M 5
M 6

18.2
20.2

FLAG T20P
-

-
SDRT25P



GFIR-L AXIAL



PRAMET

G



Utensile esterno per scanalatura frontale con staffa di bloccaggio a V per inserti LCM...03 o 04

Utensile esterno destro per scanalatura frontale con inserti mono o bi-taglienti LCM...0313, 0316, 0413 o 0416. Adatto per applicazioni di scanalatura frontale, profilatura o aperture di scanalature frontali da Ø17 a Ø230 mm, con profondità massima di taglio di 12 mm. Disponibile con stelo dimensione 25x25 mm. Corpo trattato per una maggiore durata.

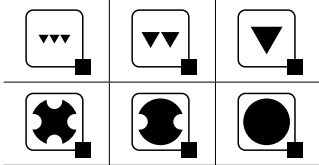
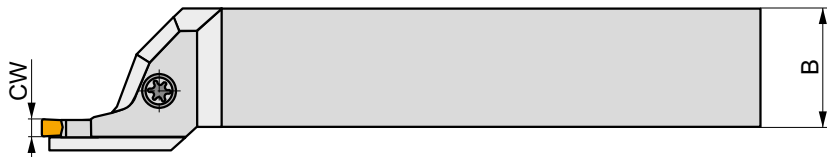
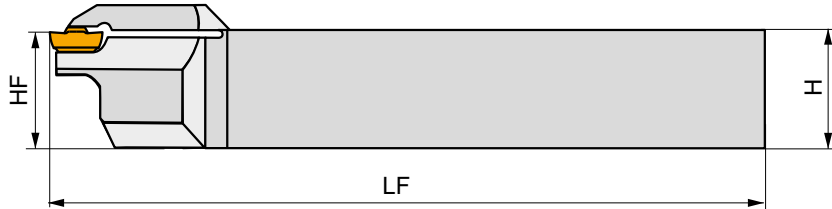
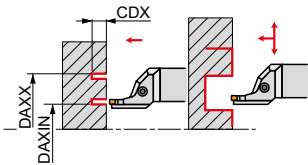

Codice prodotto	HF	H	B	LF	CW	CDX	DAXIN	DAXX	kg		
	(mm)	(mm)	(mm)	(mm)	(mm)	(mm)	(mm)	(mm)			
GFIR 2525 M 03L 030017-A	25	25	25	150	3.00	9	17	30	0.65	G1143	GL07
GFIR 2525 M 03L 039024-A	25	25	25	150	3.00	9	24	39	0.68	G1143	GL07
GFIR 2525 M 03L 050033-A	25	25	25	150	3.00	9	33	50	0.65	G1143	GL07
GFIR 2525 M 03L 060043-A	25	25	25	150	3.00	9	43	60	0.68	G1143	GL07
GFIR 2525 M 03L 076053-A	25	25	25	150	3.00	9	53	76	0.69	G1143	GL07
GFIR 2525 M 03L 100070-A	25	25	25	150	3.00	9	70	100	0.75	G1136	GL08
GFIR 2525 M 03L 130090-A	25	25	25	150	3.00	9	90	130	0.76	G1136	GL08
GFIR 2525 M 03L 170110-A	25	25	25	150	3.00	9	110	170	0.68	G1136	GL08
GFIR 2525 M 04L 030017-A	25	25	25	150	3.00	9	17	30	0.68	G1170	GL07
GFIR 2525 M 04L 034021-A	25	25	25	150	4.00	9	21	34	0.68	G1170	GL07
GFIR 2525 M 04L 040026-A	25	25	25	150	4.00	11	26	40	0.68	G1170	GL07
GFIR 2525 M 04L 050032-A	25	25	25	150	4.00	11	32	50	0.66	G1170	GL07
GFIR 2525 M 04L 060042-A	25	25	25	150	4.00	11	42	60	0.69	G1170	GL07
GFIR 2525 M 04L 075052-A	25	25	25	150	4.00	11	52	75	0.67	G1170	GL07
GFIR 2525 M 04L 100070-A	25	25	25	150	4.00	12	70	100	0.72	G1137	GL08
GFIR 2525 M 04L 130090-A	25	25	25	150	4.00	12	90	130	0.75	G1137	GL08
GFIR 2525 M 04L 170110-A	25	25	25	150	4.00	12	110	170	0.72	G1137	GL08
GFIR 2525 M 04L 230140-A	25	25	25	150	4.00	12	140	230	0.79	G1137	GL08

R



G1136
G1137
G1143
G1170

LCM. 0316..
LCM. 0416..
LCM. 0313..
LCM. 0413..



GL07
GL08

US 5018-T20P
US 6020-T25P

5.0
6.0

M5
M6

18.2
20.2

FLAG T20P
-

-
SDRT25P



GFIR-R AXIAL

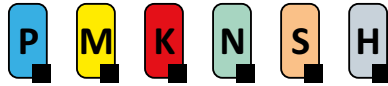

PRAMET

G



Utensile esterno per scanalatura frontale con staffa di bloccaggio a V per inserti LCM...03

Utensile esterno destro per scanalatura frontale con inserti mono o bi-taglienti LCM...0313 o 0316. Adatto per applicazioni di scanalatura frontale, profilatura o aperture di scanalature frontali da Ø17 a Ø170 mm, con profondità massima di taglio di 9 mm. Disponibile con stelo dimensione 25x25 mm. Corpo trattato per una maggiore durata.

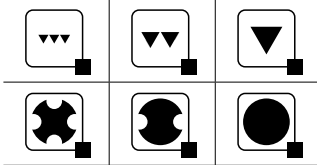
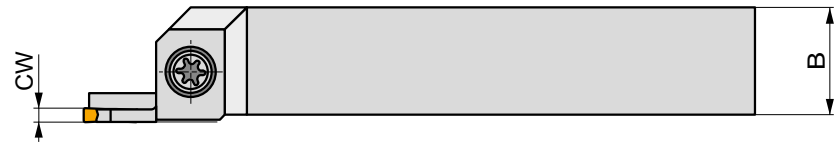
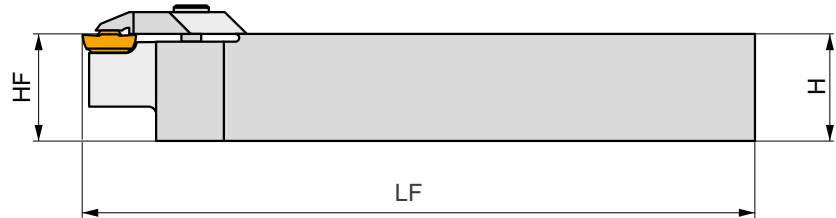
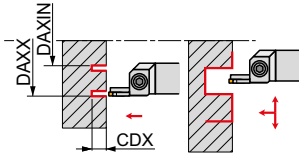

Codice prodotto	HF	H	B	LF	CW	CDX	DAXIN	DAXX	kg		
	(mm)	(mm)	(mm)	(mm)	(mm)	(mm)	(mm)	(mm)			
GFIR 2525 M 0313R 030017	25	25	25	150	3.00	9	17	30	0.65	G1143	GL02
GFIR 2525 M 0313R 039024	25	25	25	150	3.00	9	24	39	0.66	G1143	GL07
GFIR 2525 M 0313R 050033	25	25	25	150	3.00	9	33	50	0.68	G1143	GL07
GFIR 2525 M 0313R 060043	25	25	25	150	3.00	9	43	60	0.68	G1143	GL07
GFIR 2525 M 0313R 076053	25	25	25	150	3.00	9	53	76	0.68	G1143	GL07
GFIR 2525 M 0316R 100070	25	25	25	150	3.00	9	70	100	0.69	G1136	GL07
GFIR 2525 M 0316R 130090	25	25	25	150	3.00	9	90	130	0.70	G1136	GL07
GFIR 2525 M 0316R 170110	25	25	25	150	3.00	9	110	170	0.70	G1136	GL07



G1136

G1143



LCM. 0316..

LCM. 0313..



GL02

GL07



US 5015-T20P

US 5018-T20P



Nm

5.0

5.0



M 5

M 5



15

18.2



FLAG T20P

FLAG T20P



GFML-L AXIAL

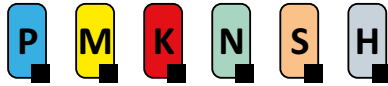

PRAMET

G



Utensile esterno per scanalatura frontale, staffa di bloccaggio a V, per inserti LCM. 04

Utensile esterno sinistro per scanalatura frontale con inserti LCM mono o bi-taglienti, dimensioni 0413 o 0416. Adatto per applicazioni di scanalatura frontale profonda e profilatura su diametri da Ø17 a Ø230 mm, con profondità massima di taglio 20 mm. Disponibile con misura stelo 25x25 mm. Corpo trattato per una maggiore durata dell'utensile.

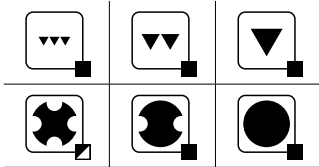
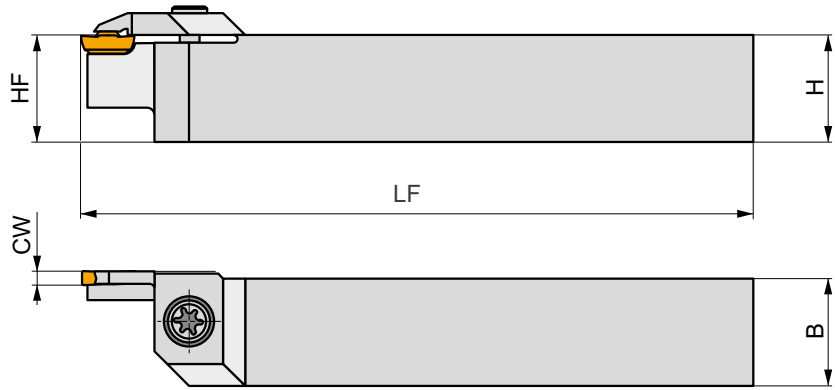
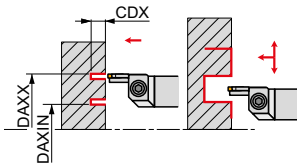

Codice prodotto	HF	H	B	LF	CW	CDX	DAXIN	DAXX	kg		
	(mm)	(mm)	(mm)	(mm)	(mm)	(mm)	(mm)	(mm)			
GFML 2525 M 0413L 030017	25	25	25	150	4.00	20	17	30	0.62	G1170	GL02
GFML 2525 M 0413L 034021	25	25	25	150	4.00	20	21	34	0.63	G1170	GL07
GFML 2525 M 0413L 040026	25	25	25	150	4.00	20	26	40	0.65	G1170	GL07
GFML 2525 M 0413L 050032	25	25	25	150	4.00	20	32	50	0.64	G1170	GL07
GFML 2525 M 0413L 060042	25	25	25	150	4.00	20	42	60	0.65	G1170	GL07
GFML 2525 M 0413L 075052	25	25	25	150	4.00	20	52	75	0.66	G1170	GL07
GFML 2525 M 0416L 100070	25	25	25	150	4.00	20	70	100	0.66	G1137	GL07
GFML 2525 M 0416L 130090	25	25	25	150	4.00	20	90	130	0.67	G1137	GL07
GFML 2525 M 0416L 170110	25	25	25	150	4.00	20	110	170	0.67	G1137	GL07
GFML 2525 M 0416L 230140	25	25	25	150	4.00	20	140	230	0.67	G1137	GL07



G1137
G1170

LCM. 0416..
LCM. 0413..



GL02
GL07

US 5015-T20P
US 5018-T20P

5.0
5.0

M 5
M 5

15
18.2

FLAG T20P
FLAG T20P



GFML-R AXIAL

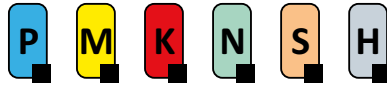

PRAMET

G



Utensile esterno per scanalatura frontale, staffa di bloccaggio a V, per inserti LCM. 04

Utensile esterno sinistro per scanalatura frontale con inserti LCM mono o bi-taglienti, dimensioni 0413 o 0416. Adatto per applicazioni di scanalatura frontale profonda e profilatura, diametri da Ø17 a Ø230 mm, con profondità massima di taglio 20 mm. Disponibile con misura stelo 25x25 mm. Corpo trattato per una maggiore durata dell'utensile.

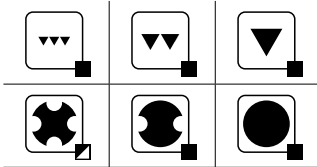
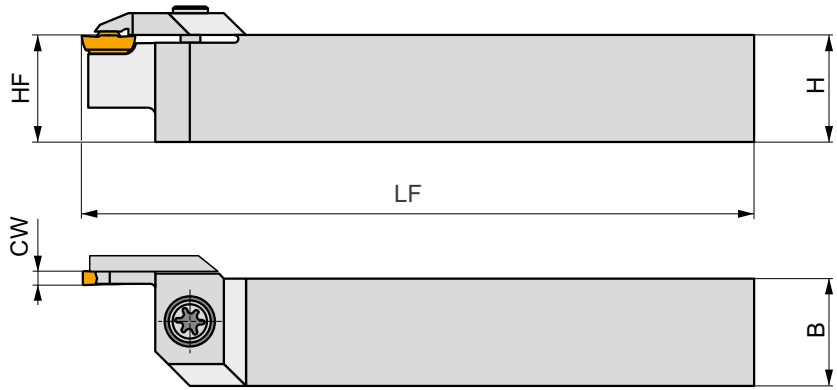
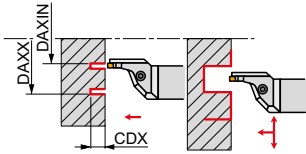

Codice prodotto	HF	H	B	LF	CW	CDX	DAXIN	DAXX	kg	G1	G2
	(mm)	(mm)	(mm)	(mm)	(mm)	(mm)	(mm)	(mm)			
GFML 2525 M 0413R 030017	25	25	25	150	4.00	20	17	30	0.68	G1170	GL07
GFML 2525 M 0413R 034021	25	25	25	150	4.00	20	21	34	0.69	G1170	GL07
GFML 2525 M 0413R 040026	25	25	25	150	4.00	20	26	40	0.69	G1170	GL07
GFML 2525 M 0413R 050032	25	25	25	150	4.00	20	32	50	0.68	G1170	GL07
GFML 2525 M 0413R 060042	25	25	25	150	4.00	20	42	60	0.69	G1170	GL07
GFML 2525 M 0413R 075052	25	25	25	150	4.00	20	52	75	0.69	G1170	GL07
GFML 2525 M 0416R 100070	25	25	25	150	4.00	20	70	100	0.80	G1137	GL08
GFML 2525 M 0416R 130090	25	25	25	150	4.00	20	90	130	0.78	G1137	GL08
GFML 2525 M 0416R 170110	25	25	25	150	4.00	20	110	170	0.78	G1137	GL08
GFML 2525 M 0416R 230140	25	25	25	150	4.00	20	140	230	0.78	G1137	GL08



G1137

G1170



LCM. 0416..

LCM. 0413..



GL07

GL08



US 5018-T20P

US 6020-T25P



5.0

6.0



M 5

M 6



18.2

20.2



FLAGT20P

-



-

SDRT25P



GFMR-L AXIAL

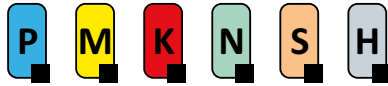

PRAMET

G



Utensile esterno per scanalatura frontale con staffa di bloccaggio a V per inserti LCM...04

Utensile esterno destro per scanalatura frontale con inserti LCM...0413 o 0416 bi-taglienti. Adatto per applicazioni di scanalatura frontale profonda, profilatura o aperture di scanalature frontali da Ø17 a Ø230 mm, con profondità massima di taglio di 20 mm. Disponibile con stelo dimensione 25x25 mm. Corpo trattato per una maggiore durata.

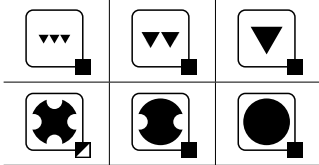
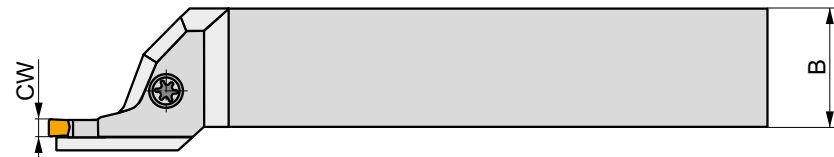
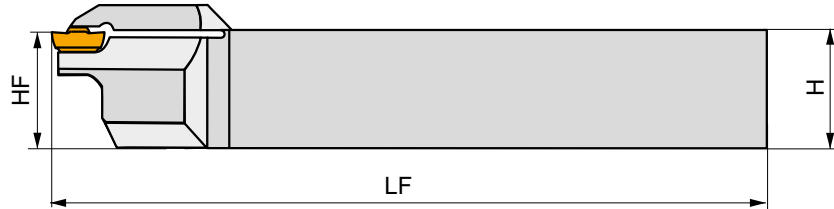
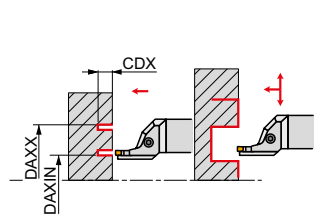

Codice prodotto	HF	H	B	LF	CW	CDX	DAXIN	DAXX	kg	G1170	G1170
	(mm)	(mm)	(mm)	(mm)	(mm)	(mm)	(mm)	(mm)			
GFMR 2525 M 0413L 030017	25	25	25	150	4.00	20	17	30	0.70	G1170	GL07
GFMR 2525 M 0413L 034021	25	25	25	150	4.00	20	21	34	0.66	G1170	GL07
GFMR 2525 M 0413L 040026	25	25	25	150	4.00	20	26	40	0.66	G1170	GL07
GFMR 2525 M 0413L 050032	25	25	25	150	4.00	20	32	50	0.68	G1170	GL07
GFMR 2525 M 0413L 060042	25	25	25	150	4.00	20	42	60	0.66	G1170	GL07
GFMR 2525 M 0413L 075052	25	25	25	150	4.00	20	52	75	0.69	G1170	GL07
GFMR 2525 M 0416L 100070	25	25	25	150	4.00	20	70	100	0.88	G1137	GL08
GFMR 2525 M 0416L 130090	25	25	25	150	4.00	20	90	130	0.78	G1137	GL08
GFMR 2525 M 0416L 170110	25	25	25	150	4.00	20	110	170	0.81	G1137	GL08
GFMR 2525 M 0416L 230140	25	25	25	150	4.00	20	140	230	0.78	G1137	GL08

G1137	LCM. 0416..
G1170	LCM. 0413..

GL07	US 5018-T20P	5.0 Nm	M 5	18.2	FLAG T20P	-
GL08	US 6020-T25P	6.0	M 6	20.2	-	SDRT25P



GFMR-R AXIAL

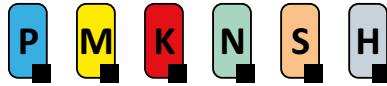

PRAMET

G



Utensile esterno per scanalatura frontale con staffa di bloccaggio a V per inserti LCM...04

Utensile esterno destro per scanalatura frontale con inserti LCM...0413 o 0416 bi-taglienti. Adatto per applicazioni di scanalatura frontale profonda, profilatura o aperture di scanalature frontali da Ø17 a Ø230 mm, con profondità massima di taglio di 20 mm. Disponibile con stelo dimensione 25x25 mm. Corpo trattato per una maggiore durata.

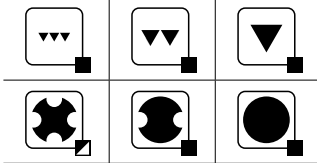
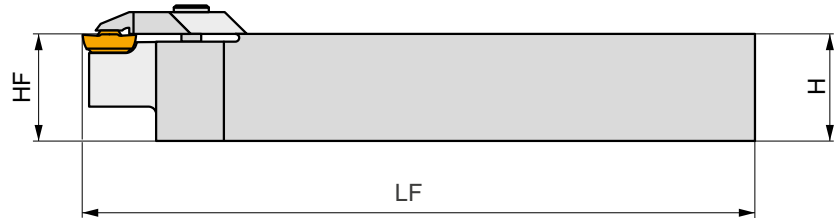
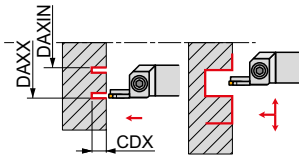

Codice prodotto	HF	H	B	LF	CW	CDX	DAXIN	DAXX	kg	G1	G2
	(mm)	(mm)	(mm)	(mm)	(mm)	(mm)	(mm)	(mm)			
GFMR 2525 M 0413R 030017	25	25	25	150	4.00	20	17	30	0.62	G1170	GL02
GFMR 2525 M 0413R 034021	25	25	25	150	4.00	20	21	34	0.63	G1170	GL07
GFMR 2525 M 0413R 040026	25	25	25	150	4.00	20	26	40	0.64	G1170	GL07
GFMR 2525 M 0413R 050032	25	25	25	150	4.00	20	32	50	0.63	G1170	GL07
GFMR 2525 M 0413R 060042	25	25	25	150	4.00	20	42	60	0.64	G1170	GL07
GFMR 2525 M 0413R 075052	25	25	25	150	4.00	20	52	75	0.67	G1170	GL07
GFMR 2525 M 0416R 100070	25	25	25	150	4.00	20	70	100	0.67	G1137	GL07
GFMR 2525 M 0416R 130090	25	25	25	150	4.00	20	90	130	0.66	G1137	GL07
GFMR 2525 M 0416R 170110	25	25	25	150	4.00	20	110	170	0.67	G1137	GL07
GFMR 2525 M 0416R 230140	25	25	25	150	4.00	20	140	230	0.68	G1137	GL07



G1137
G1170

LCM. 0416..
LCM. 0413..



GL02
GL07

US 5015-T20P
US 5018-T20P

5.0
5.0

M 5
M 5

15
18.2

FLAG T20P
FLAG T20P



GGI(RL)-90 AXIAL



PRAMET

G



Utensile esterno a 90° per scanalatura frontale, staffa di bloccaggio a V, per inserti LCM.03

Utensile esterno a 90°, destro / sinistro, per scanalatura frontale con inserti LCM mono o bi-taglienti 0313 o 0316. Adatto per applicazioni di scanalatura frontale, profilatura o allargamento diametri da Ø17 a Ø170 mm, con profondità massima di taglio 11 mm. Disponibile con misura stelo 25x25 mm. Corpo trattato per una maggiore durata dell'utensile.

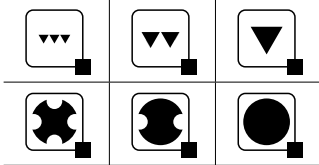
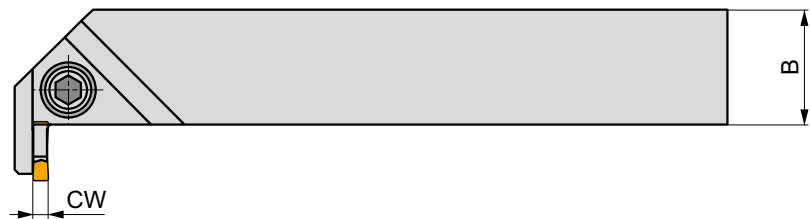
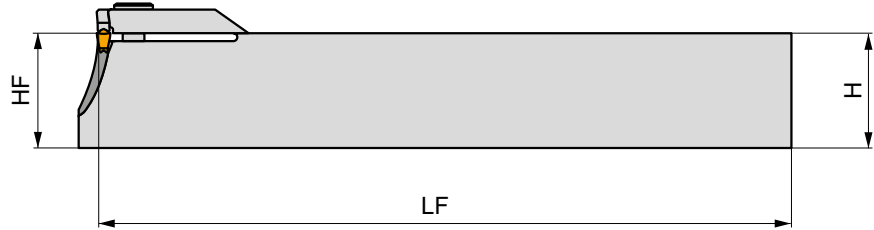
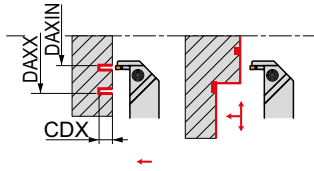

Codice prodotto	HF	H	B	LF	CW	CDX	DAXIN	DAXX	kg		
	(mm)	(mm)	(mm)	(mm)	(mm)	(mm)	(mm)	(mm)			
R GGIR 2525 M 03R 030017	25	25	25	150	3.00	9.5	17	30	0.75	GI143	GL01
GGIR 2525 M 03R 039024	25	25	25	150	3.00	9.5	24	39	0.78	GI143	GL01
GGIR 2525 M 03R 050033	25	25	25	150	3.00	11	33	50	0.75	GI143	GL01
GGIR 2525 M 03R 060043	25	25	25	150	3.00	11	43	60	0.78	GI143	GL01
GGIR 2525 M 03R 076053	25	25	25	150	3.00	11	53	76	0.75	GI143	GL01
GGIR 2525 M 03R 100070	25	25	25	150	3.00	9	70	100	0.78	GI136	GL04
GGIR 2525 M 03R 130090	25	25	25	150	3.00	9	90	130	0.73	GI136	GL04
GGIR 2525 M 03R 170110	25	25	25	150	3.00	9	110	170	0.76	GI136	GL04
L GGIL 2525 M 03L 030017	25	25	25	150	3.00	9.5	17	30	0.75	GI143	GL01
GGIL 2525 M 03L 039024	25	25	25	150	3.00	9.5	24	39	0.25	GI143	GL01
GGIL 2525 M 03L 050033	25	25	25	150	3.00	11	33	50	0.75	GI143	GL01
GGIL 2525 M 03L 060043	25	25	25	150	3.00	11	43	60	0.75	GI143	GL01
GGIL 2525 M 03L 076053	25	25	25	150	3.00	11	53	76	0.75	GI143	GL01
GGIL 2525 M 03L 100070	25	25	25	150	3.00	9	70	100	0.77	GI136	GL04
GGIL 2525 M 03L 130090	25	25	25	150	3.00	9	90	130	0.77	GI136	GL04
GGIL 2525 M 03L 170110	25	25	25	150	3.00	9	110	170	0.76	GI136	GL04

GI136	LCM. 0316..
GI143	LCM. 0313..

GL01	HS 0520C	5.0	M 5	20	HXK 4
GL04	HS 0620C	6.0	M 6	20	HXK 5



LCMF 16 - CM

	CW	CWTOLL	CWTOLU	INSL
	(mm)	(mm)	(mm)	(mm)
0316	3.00	-0.05	0.05	16.4
0416	4.00	-0.05	0.05	16.4
0516	5.00	-0.05	0.05	16.4
0616	6.00	-0.05	0.05	16.4

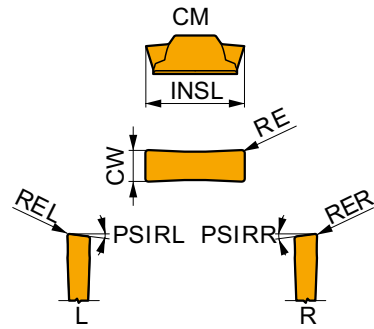

Idoneità e valori iniziali per velocità di taglio (Vc) e avanzamento (f). Fare riferimento alla nostra App Machining Calculator per ulteriori calcoli.

Codice prodotto	RE (mm)	P		M		K		N		S		H		PSIRR (°)	PSIRL (°)
		vc (m/min)	f (mm/rev)	vc (m/min)	f (mm/rev)	vc (m/min)	f (mm/rev)	vc (m/min)	f (mm/rev)	vc (m/min)	f (mm/rev)	vc (m/min)	f (mm/rev)		

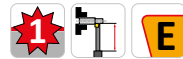
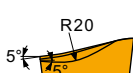

CM geometria primaria per operazioni di troncatura e scanalatura, da taglio continuo a leggermente interrotto.

LCMF 031602-CM	T8330	0.2	130	0.11	75	0.10	120	0.11	-	-	-	-	-	-	-
LCMF 031604-CM	T8330	0.4	130	0.11	75	0.10	120	0.11	-	-	-	-	-	-	-
LCMF 041602-CM	T8330	0.2	130	0.11	75	0.10	120	0.11	-	-	-	-	-	-	-
LCMF 041604-CM	T8330	0.4	130	0.11	75	0.10	120	0.11	-	-	-	-	-	-	-
LCMF 051604-CM	T8330	0.4	130	0.11	75	0.11	120	0.11	-	-	-	-	-	-	-
LCMF 061604-CM	T8330	0.4	130	0.11	75	0.11	120	0.11	-	-	-	-	-	-	-



R-CM geometria destra, scelta primaria per operazione di troncatura, da taglio continuo a leggermente interrotto.

LCMF 031602R15-CM	T8330 ¹⁾	0.2	130	0.11	75	0.10	120	0.11	-	-	-	-	15	-
LCMF 031602R6-CM	T8330	0.2	130	0.11	75	0.10	120	0.11	-	-	-	-	6	-
LCMF 041602R15-CM	T8330 ¹⁾	0.2	130	0.11	75	0.10	120	0.11	-	-	-	-	15	-
LCMF 041602R6-CM	T8330	0.2	130	0.11	75	0.10	120	0.11	-	-	-	-	6	-



L-CM geometria sinistra, scelta primaria per operazioni di troncatura, da taglio continuo a leggermente interrotto.

LCMF 031602L15-CM	T8330 ¹⁾	0.2	130	0.11	75	0.10	120	0.11	-	-	-	-	-	15
LCMF 031602L6-CM	T8330	0.2	130	0.11	75	0.10	120	0.11	-	-	-	-	-	6
LCMF 041602L15-CM	T8330 ¹⁾	0.2	130	0.11	75	0.10	120	0.11	-	-	-	-	-	15
LCMF 041602L6-CM	T8330	0.2	130	0.11	75	0.10	120	0.11	-	-	-	-	-	6

¹⁾ I portautensili devono essere modificati.



LCMF 16, LCMF 30 - F



	CW	CWTOLL	CWTOLU	INSL
	(mm)	(mm)	(mm)	(mm)
0316	3.00	-0.05	0.05	16.4
0416	4.00	-0.05	0.05	16.4
0516	5.00	-0.05	0.05	16.4
0616	6.00	-0.05	0.05	16.4
0830	8.00	-0.05	0.05	30.0

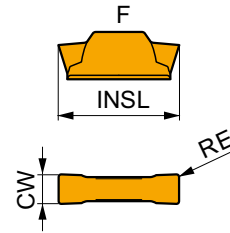

Idoneità e valori iniziali per velocità di taglio (Vc), avanzamento (f) e profondità di taglio (ap). Fare riferimento alla nostra App Machining Calculator per ulteriori calcoli.

Codice prodotto	RE	P			M			K			N			S			H		
		vc	f	ap	vc	f	ap	vc	f	ap	vc	f	ap	vc	f	ap	vc	f	ap
	(mm)	(m/min)	(mm/rev)	(mm)	(m/min)	(mm/rev)	(mm)	(m/min)	(mm/rev)	(mm)	(m/min)	(mm/rev)	(mm)	(m/min)	(mm/rev)	(mm)	(m/min)	(mm/rev)	(mm)

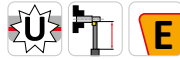
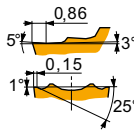

F geometria per operazioni di troncatura, scanalatura e tornitura frontale, adatto per lavorazioni leggere e finitura, da taglio continuo a leggermente interrotto.

LCMF 031602-F	T8330	0.2	195	0.10	0.3	115	0.09	0.3	185	0.10	0.3	-	-	-	-	-	-	-	-
LCMF 031604-F	T8330	0.4	200	0.10	0.5	120	0.09	0.5	190	0.10	0.5	-	-	-	-	-	-	-	-
LCMF 041604-F	T8330	0.4	185	0.13	0.5	110	0.12	0.5	175	0.13	0.5	-	-	-	-	-	-	-	-
	T9325	0.4	275	0.13	0.5	165	0.12	0.5	260	0.13	0.5	-	-	-	-	-	-	-	-
LCMF 041608-F	T8330	0.8	205	0.13	1.0	120	0.12	1.0	190	0.13	1.0	-	-	-	-	-	-	-	-
	T9325	0.8	305	0.13	1.0	180	0.12	1.0	285	0.13	1.0	-	-	-	-	-	-	-	-
LCMF 051608-F	T8330	0.8	195	0.15	1.0	115	0.14	1.0	185	0.15	1.0	-	-	-	-	-	-	-	-
	T9325	0.8	285	0.15	1.0	170	0.14	1.0	270	0.15	1.0	-	-	-	-	-	-	-	-
LCMF 061608-F	T8330	0.8	190	0.17	1.0	110	0.15	1.0	180	0.17	1.0	-	-	-	-	-	-	-	-
	T9325	0.8	270	0.17	1.0	160	0.15	1.0	255	0.17	1.0	-	-	-	-	-	-	-	-

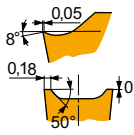

F geometria per operazioni di troncatura, scanalatura e tornitura frontale, adatto per lavorazioni leggere e finitura, da taglio continuo a leggermente interrotto.

LCMF 083008-F	T8330	0.8	175	0.25	1.0	105	0.23	1.0	165	0.25	1.0	-	-	-	-	-	-	-	-
LCMF 083012-F	T8330	1.2	170	0.25	1.5	100	0.23	1.5	160	0.25	1.5	-	-	-	-	-	-	-	-



LCMF 16 - M

PRAMET

	CW	CWTOLL	CWTOLU	INSL
	(mm)	(mm)	(mm)	(mm)
0316	3.00	-0.05	0.05	16.4
0416	4.00	-0.05	0.05	16.4
0516	5.00	-0.05	0.05	16.4
0616	6.00	-0.05	0.05	16.4

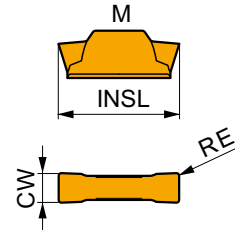

Idoneità e valori iniziali per velocità di taglio (Vc), avanzamento (f) e profondità di taglio (ap). Fare riferimento alla nostra App Machining Calculator per ulteriori calcoli.

Codice prodotto	RE	P			M			K			N			S			H		
		vc	f	ap	vc	f	ap	vc	f	ap	vc	f	ap	vc	f	ap	vc	f	ap
	(mm)	(m/min)	(mm/rev)	(mm)	(m/min)	(mm/rev)	(mm)	(m/min)	(mm/rev)	(mm)	(m/min)	(mm/rev)	(mm)	(m/min)	(mm/rev)	(mm)	(m/min)	(mm/rev)	(mm)

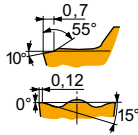

M geometria per operazioni di scanalatura e tornitura longitudinale, da taglio continuo a interrotto.

LCMF 031602-M	T8330	0.2	160	0.13	1.0	95	0.12	1.0	150	0.13	1.0	-	-	-	30	0.15	1.0
LCMF 031604-M	T8330	0.4	170	0.13	1.0	100	0.12	1.0	160	0.13	1.0	-	-	-	30	0.15	1.0
LCMF 041604-M	T8330	0.4	155	0.18	1.0	90	0.16	1.0	145	0.18	1.0	-	-	-	30	0.15	1.0
	T9325	0.4	225	0.18	1.0	135	0.16	1.0	210	0.18	1.0	-	-	-	-	-	-
LCMF 041608-M	T8330	0.8	185	0.18	1.0	110	0.16	1.0	175	0.18	1.0	-	-	-	35	0.15	1.0
	T9325	0.8	265	0.18	1.0	155	0.16	1.0	250	0.18	1.0	-	-	-	-	-	-
LCMF 051608-M	T8330	0.8	180	0.20	1.0	105	0.18	1.0	170	0.20	1.0	-	-	-	35	0.15	1.0
	T9325	0.8	255	0.20	1.0	150	0.18	1.0	240	0.20	1.0	-	-	-	-	-	-
LCMF 061608-M	T8330	0.8	175	0.25	1.0	105	0.23	1.0	165	0.25	1.0	-	-	-	35	0.15	1.0
	T9325	0.8	230	0.25	1.0	135	0.23	1.0	215	0.25	1.0	-	-	-	-	-	-

LCMF 16, LCMF 30 - MP

PRAMET

	CW	CWTOLL	CWTOLU	INSL
	(mm)	(mm)	(mm)	(mm)
0316	3.00	-0.05	0.05	17.5
0416	4.00	-0.05	0.05	17.6
0516	5.00	-0.05	0.05	18.3
0616	6.00	-0.05	0.05	18.5
0830	8.00	-0.05	0.05	30.9

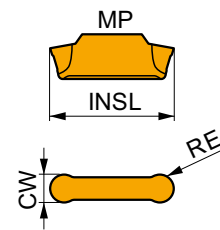

Idoneità e valori iniziali per velocità di taglio (Vc), avanzamento (f) e profondità di taglio (ap). Fare riferimento alla nostra App Machining Calculator per ulteriori calcoli.

Codice prodotto	RE	P			M			K			N			S			H		
		vc	f	ap	vc	f	ap	vc	f	ap	vc	f	ap	vc	f	ap	vc	f	ap
	(mm)	(m/min)	(mm/rev)	(mm)	(m/min)	(mm/rev)	(mm)	(m/min)	(mm/rev)	(mm)	(m/min)	(mm/rev)	(mm)	(m/min)	(mm/rev)	(mm)	(m/min)	(mm/rev)	(mm)

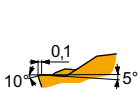

MP geometria per operazioni di tornitura longitudinale e copiatura, da taglio continuo a interrotto.

LCMF 0316M0-MP	T8330	1.5	190	0.30	0.8	110	0.27	0.8	180	0.30	0.8	-	-	-	-	-	-
LCMF 0416M0-MP	T8330	2.0	175	0.40	1.0	105	0.36	1.0	165	0.40	1.0	-	-	-	-	-	-
	T9325	2.0	220	0.40	1.0	130	0.36	1.0	205	0.40	1.0	-	-	-	-	-	-
LCMF 0516M0-MP	T8330	2.5	170	0.45	1.0	100	0.41	1.0	160	0.45	1.0	-	-	-	-	-	-
	T9325	2.5	205	0.45	1.0	120	0.41	1.0	190	0.45	1.0	-	-	-	-	-	-



Idoneità e valori iniziali per velocità di taglio (Vc), avanzamento (f) e profondità di taglio (ap). Fare riferimento alla nostra App Machining Calculator per ulteriori calcoli.

Codice prodotto	RE (mm)	P			M			K			N			S			H		
		vc (m/min)	f (mm/rev)	ap (mm)	vc (m/min)	f (mm/rev)	ap (mm)	vc (m/min)	f (mm/rev)	ap (mm)	vc (m/min)	f (mm/rev)	ap (mm)	vc (m/min)	f (mm/rev)	ap (mm)	vc (m/min)	f (mm/rev)	ap (mm)

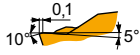

MP geometria per operazioni di tornitura longitudinale e copiatura, da taglio continuo a interrotto.

LCMF 0616MO-MP	T8330	3.0	165	0.50	1.0	95	0.45	1.0	155	0.50	1.0	-	-	-	-	-	-	-
	T9325	3.0	200	0.50	1.0	120	0.45	1.0	190	0.50	1.0	-	-	-	-	-	-	-
LCMF 0830MO-MP	T8330	4.0	150	0.60	1.2	90	0.54	1.2	140	0.60	1.2	-	-	-	-	-	-	-

LCMR 16 - CM



	CW (mm)	CWTOLL (mm)	CWTOLU (mm)	INSL (mm)
0316	3.00	-0.05	0.05	16.4
0416	4.00	-0.05	0.05	16.4

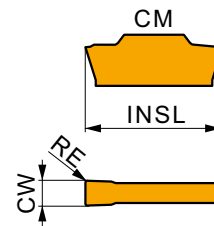

Idoneità e valori iniziali per velocità di taglio (Vc) e avanzamento (f). Fare riferimento alla nostra App Machining Calculator per ulteriori calcoli.

Codice prodotto	RE (mm)	P		M		K		N		S		H		PSIRR (°)	PSIRL (°)
		vc (m/min)	f (mm/rev)	vc (m/min)	f (mm/rev)	vc (m/min)	f (mm/rev)	vc (m/min)	f (mm/rev)	vc (m/min)	f (mm/rev)				

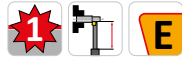
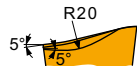

CM geometria primaria per operazioni di troncatura e scanalatura, da taglio continuo a leggermente interrotto.

LCMR 031602-CM	T8330	0.2	130	0.11	75	0.10	120	0.11	-	-	-	-	-	-	-
LCMR 041604-CM	T8330	0.4	130	0.11	75	0.10	120	0.11	-	-	-	-	-	-	-



LCMR 16, LCMR 30 - F

	CW	CWTOLL	CWTOLU	INSL
	(mm)	(mm)	(mm)	(mm)
0316	3.00	-0.05	0.05	16.4
0416	4.00	-0.05	0.05	16.4
0516	5.00	-0.05	0.05	16.4
0616	6.00	-0.05	0.05	16.4
0830	8.00	-0.05	0.05	30.0

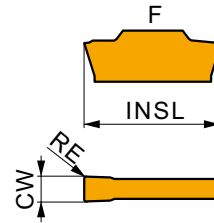

Idoneità e valori iniziali per velocità di taglio (Vc), avanzamento (f) e profondità di taglio (ap). Fare riferimento alla nostra App Machining Calculator per ulteriori calcoli.

Codice prodotto	RE (mm)	P			M			K			N			S			H		
		vc (m/min)	f (mm/rev)	ap (mm)	vc (m/min)	f (mm/rev)	ap (mm)	vc (m/min)	f (mm/rev)	ap (mm)	vc (m/min)	f (mm/rev)	ap (mm)	vc (m/min)	f (mm/rev)	ap (mm)	vc (m/min)	f (mm/rev)	ap (mm)

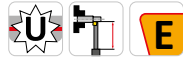
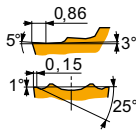

F geometria per operazioni di troncatura, scanalatura e tornitura longitudinale, adatto per lavorazioni leggere e finitura, da taglio continuo a leggermente interrotto.

LCMR 031604-F	T8330	0.4	200	0.10	0.5	120	0.09	0.5	190	0.10	0.5	-	-	-	-	-	-	-	-
LCMR 041604-F	T8330	0.4	185	0.13	0.5	110	0.12	0.5	175	0.13	0.5	-	-	-	-	-	-	-	-
LCMR 051604-F	T8330	0.4	180	0.15	0.5	105	0.14	0.5	170	0.15	0.5	-	-	-	-	-	-	-	-
LCMR 061608-F	T8330	0.8	190	0.17	1.0	110	0.15	1.0	180	0.17	1.0	-	-	-	-	-	-	-	-

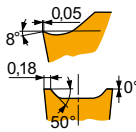

F geometria per operazioni di troncatura, scanalatura e tornitura longitudinale, adatto per lavorazioni leggere e finitura, da taglio continuo a leggermente interrotto.

LCMR 083008-F	T8330	0.8	175	0.25	1.0	105	0.23	1.0	165	0.25	1.0	-	-	-	-	-	-	-	-
---------------	-------	-----	-----	------	-----	-----	------	-----	-----	------	-----	---	---	---	---	---	---	---	---

LCMR 16 - M

	CW	CWTOLL	CWTOLU	INSL
	(mm)	(mm)	(mm)	(mm)
0316	3.00	-0.05	0.05	16.4
0416	4.00	-0.05	0.05	16.4
0516	5.00	-0.05	0.05	16.4
0616	6.00	-0.05	0.05	16.4

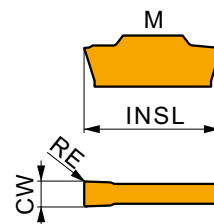

Idoneità e valori iniziali per velocità di taglio (Vc), avanzamento (f) e profondità di taglio (ap). Fare riferimento alla nostra App Machining Calculator per ulteriori calcoli.

Codice prodotto	RE (mm)	P			M			K			N			S			H		
		vc (m/min)	f (mm/rev)	ap (mm)	vc (m/min)	f (mm/rev)	ap (mm)	vc (m/min)	f (mm/rev)	ap (mm)	vc (m/min)	f (mm/rev)	ap (mm)	vc (m/min)	f (mm/rev)	ap (mm)	vc (m/min)	f (mm/rev)	ap (mm)

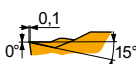
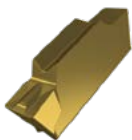

M geometria per operazioni di scanalatura e tornitura longitudinale, da taglio continuo a interrotto.

LCMR 031604-M	T8330	0.4	170	0.13	1.0	100	0.12	1.0	160	0.13	1.0	-	-	-	-	-	-	30	0.15	1.0
LCMR 041604-M	T8330	0.4	155	0.18	1.0	90	0.16	1.0	145	0.18	1.0	-	-	-	-	-	-	30	0.15	1.0
LCMR 051604-M	T8330	0.4	150	0.20	1.0	90	0.18	1.0	140	0.20	1.0	-	-	-	-	-	-	30	0.15	1.0
LCMR 061608-M	T8330	0.8	175	0.25	1.0	105	0.23	1.0	165	0.25	1.0	-	-	-	-	-	-	35	0.15	1.0



LCMR 16 - MP

	CW	CWTOLL	CWTOLU	INSL
	(mm)	(mm)	(mm)	(mm)
0316	3.00	-0.05	0.05	17.4
0416	4.00	-0.05	0.05	17.5
0516	5.00	-0.05	0.05	18.1
0616	6.00	-0.05	0.05	18.3

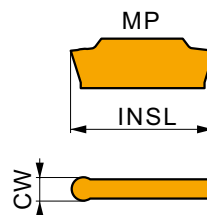

Idoneità e valori iniziali per velocità di taglio (V_c), avanzamento (f) e profondità di taglio (a_p). Fare riferimento alla nostra App Machining Calculator per ulteriori calcoli.

Codice prodotto	RE (mm)	P			M			K			N			S			H		
		v_c (m/min)	f (mm/rev)	a_p (mm)	v_c (m/min)	f (mm/rev)	a_p (mm)	v_c (m/min)	f (mm/rev)	a_p (mm)	v_c (m/min)	f (mm/rev)	a_p (mm)	v_c (m/min)	f (mm/rev)	a_p (mm)	v_c (m/min)	f (mm/rev)	a_p (mm)

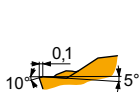

MP geometria per operazioni di tornitura longitudinale e copiatura, da taglio continuo a interrotto.

LCMR 0316MO-MP	T8330	1.5	190	0.30	0.8	110	0.27	0.8	180	0.30	0.8	-	-	-	-	-	-	-	-
LCMR 0416MO-MP	T8330	2.0	175	0.40	1.0	105	0.36	1.0	165	0.40	1.0	-	-	-	-	-	-	-	-
LCMR 0516MO-MP	T8330	2.5	170	0.45	1.0	100	0.41	1.0	160	0.45	1.0	-	-	-	-	-	-	-	-
LCMR 0616MO-MP	T8330	3.0	165	0.50	1.0	95	0.45	1.0	155	0.50	1.0	-	-	-	-	-	-	-	-



GFI(RL) EXT

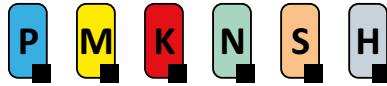

PRAMET

G





Utensile esterno per scanalatura e tornitura, staffa di bloccaggio a V, per inserti LCM

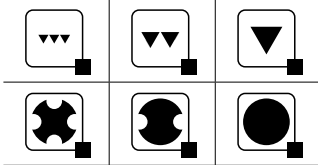
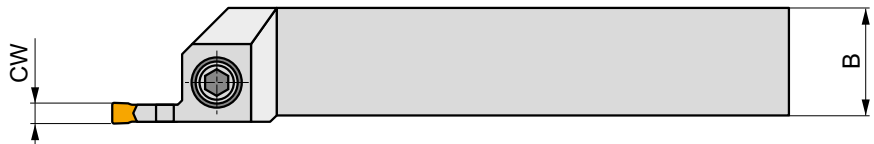
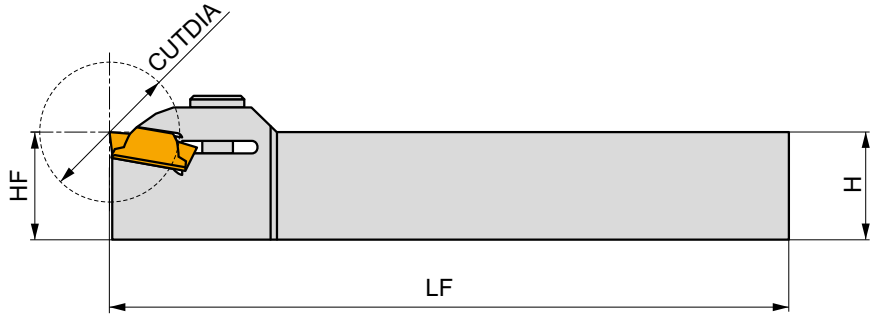
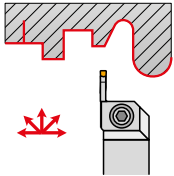





Utensile per scanalatura esterno destro / sinistro, con inserti LCM. 0316, 0416, 0516, 0616 e 0830. Adatto per applicazioni di scanalatura esterna, profilatura, tornitura longitudinale e troncatura fino a un massimo di Ø48 mm di diametro. Disponibile con dimensioni stelo da 16x16 fino a 32x25 mm. Corpo trattato per una maggiore durata dell'utensile.



Codice prodotto	≡	H	B	L	CW	CUTDIA	kg			
	(mm)	(mm)	(mm)	(mm)	(mm)	(mm)				
R	GFIR 1616 H 03	16	16	16	100	3.00	18	0.22	G1136	GL03
	GFIR 2020 K 03	20	20	20	125	3.00	18	0.40	G1136	GL04
	GFIR 2525 M 03	25	25	25	150	3.00	18	0.73	G1136	GL05
	GFIR 1616 H 04	16	16	16	100	4.00	24	0.22	G1137	GL03
	GFIR 2020 K 04	20	20	20	125	4.00	24	0.38	G1137	GL04
	GFIR 2525 M 04	25	25	25	150	4.00	24	0.67	G1137	GL05
	GFIR 2020 K 05	20	20	20	125	5.00	28	0.38	G1138	GL04
	GFIR 2525 M 05	25	25	25	150	5.00	28	0.70	G1138	GL05
	GFIR 2020 K 06	20	20	20	125	6.00	28	0.38	G1139	GL04
	GFIR 2525 M 06	25	25	25	150	6.00	28	0.70	G1139	GL05
	GFIR 2525 M 08	25	25	25	150	8.00	48	0.74	G1193	GL09
	GFIR 3225 P 08	32	32	25	170	8.00	48	1.03	G1193	GL09
L	GFIL 1616 H 03	16	16	16	100	3.00	18	0.22	G1136	GL03
	GFIL 2020 K 03	20	20	20	125	3.00	18	0.39	G1136	GL04
	GFIL 2525 M 03	25	25	25	150	3.00	18	0.73	G1136	GL05
	GFIL 1616 H 04	16	16	16	100	4.00	24	0.20	G1137	GL03
	GFIL 2020 K 04	20	20	20	125	4.00	24	0.38	G1137	GL04
	GFIL 2525 M 04	25	25	25	150	4.00	24	0.69	G1137	GL05
	GFIL 2020 K 05	20	20	20	125	5.00	28	0.38	G1138	GL04
	GFIL 2525 M 05	25	25	25	150	5.00	28	0.71	G1138	GL05
	GFIL 2020 K 06	20	20	20	125	6.00	28	0.40	G1139	GL04
	GFIL 2525 M 06	25	25	25	150	6.00	28	0.70	G1139	GL05
	GFIL 2525 M 08	25	25	25	150	8.00	48	0.75	G1193	GL09
	GFIL 3225 P 08	32	32	25	170	8.00	48	1.03	G1193	GL09



	
GI136	LCM. 0316..
GI137	LCM. 0416..
GI138	LCM. 0516..
GI139	LCM. 0616..
GI193	LCM. 0830..

					
GL03	HS 0616C	6.0	M 6	16	HXX 5
GL04	HS 0620C	6.0	M 6	20	HXX 5
GL05	HS 0625C	6.0	M 6	25	HXX 5
GL09	HSI 1020	8.0	M 10	20	HXX 8



GFM(RL) EXT

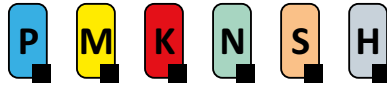

PRAMET

G



Utensile esterno per scanalatura e tornitura, staffa di bloccaggio a V, per inserti LCM

Utensile per scanalatura esterno destro / sinistro, con inserti LCM 0316, 0416, 0516, 0616 e 0830. Adatto per applicazioni di scanalatura esterna, profilatura, tornitura longitudinale e troncatura su diametri massimi da Ø30 a Ø80 mm. Disponibile con dimensioni stelo da 20x20 fino a 32x25 mm. Corpo trattato per una maggiore durata dell'utensile.

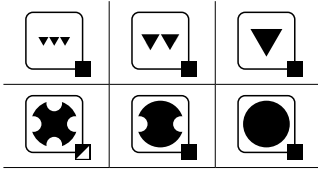
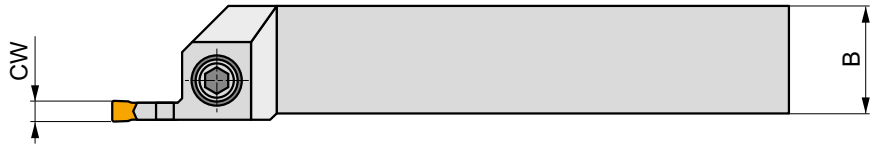
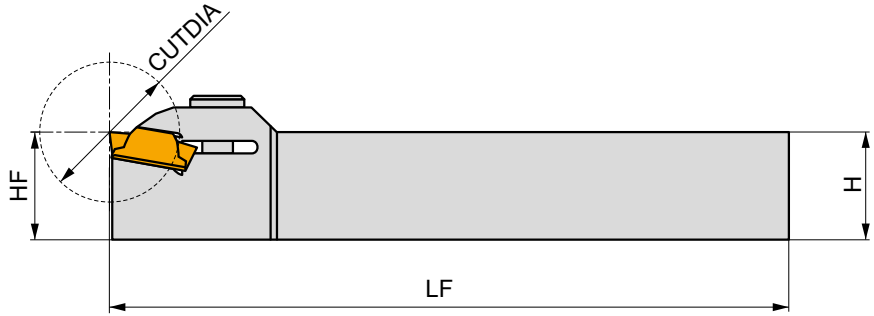
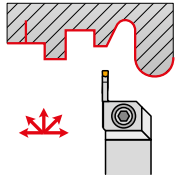

Codice prodotto	HF	H	B	LF	CW	CUTDIA	kg			
	(mm)	(mm)	(mm)	(mm)	(mm)	(mm)				
R	GFMR 2020 K 0316	20	20	20	125	3.00	30	0.37	G1136	GL04
	GFMR 2525 M 0316	25	25	25	150	3.00	30	0.68	G1136	GL04
	GFMR 2020 K 0416	20	20	20	125	4.00	40	0.38	G1137	GL04
	GFMR 2525 M 0416	25	25	25	150	4.00	40	0.68	G1137	GL04
	GFMR 2525 M 0516	25	25	25	150	5.00	50	0.67	G1138	GL04
	GFMR 3225 P 0516	32	32	25	170	5.00	50	0.97	G1138	GL04
	GFMR 2525 M 0616	25	25	25	150	6.00	60	0.66	G1139	GL04
	GFMR 3225 P 0616	32	32	25	170	6.00	60	0.97	G1139	GL04
	GFMR 3225 P 0830	32	32	25	170	8.00	80	0.97	G1193	GL10
L	GFML 2020 K 0316	20	20	20	125	3.00	30	0.24	G1136	GL04
	GFML 2525 M 0316	25	25	25	150	3.00	30	0.70	G1136	GL04
	GFML 2020 K 0416	20	20	20	125	4.00	40	0.37	G1137	GL04
	GFML 2525 M 0416	25	25	25	150	4.00	40	0.69	G1137	GL04
	GFML 2525 M 0516	25	25	25	150	5.00	50	0.64	G1138	GL04
	GFML 3225 P 0516	32	32	25	170	5.00	50	0.97	G1138	GL04
	GFML 2525 M 0616	25	25	25	150	6.00	60	0.64	G1139	GL04
	GFML 3225 P 0616	32	32	25	170	6.00	60	0.95	G1139	GL04
	GFML 3225 P 0830	32	32	25	170	8.00	80	0.99	G1193	GL10

G1136	LCM. 0316..
G1137	LCM. 0416..
G1138	LCM. 0516..
G1139	LCM. 0616..
G1193	LCM. 0830..

GL04	HS 0620C	6.0	M 6	20	HXK 5
GL10	HSI 1020	8.0	M 10	20	HXK 8



XLCCN B



PRAMET



Lama da troncatura a doppio lato per inserti LCM

Lama per applicazioni di troncatura fino a una profondità massima di 60 mm o barra Ø120 mm. Adatta per inserti LCM mono o bi-taglienti. Disponibile in altezza da 26 o 32 mm. Può essere alloggiata nei supporti base DU Pramet. Lama trattata per una maggiore durata.

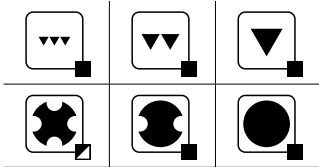
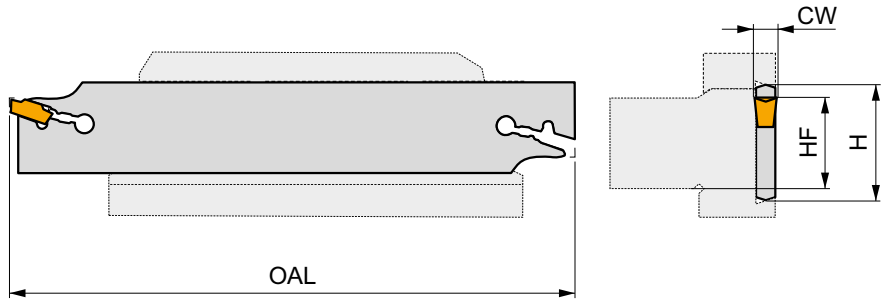
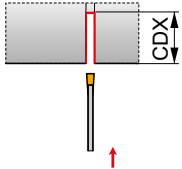

Codice prodotto	≡	H	L	CW	CDX	kg		
	(mm)	(mm)	(mm)	(mm)	(mm)			
N XLCCN 2602 J 0316	21.4	26	110	3.00	35	0.09	G136	KV1
XLCCN 3202 M 0316	25	32	150	3.00	50	0.13	G136	KV1
XLCCN 3203 M 0416	25	32	150	4.00	50	0.15	G137	KV1
XLCCN 3204 M 0516	25	32	150	5.00	60	0.18	G138	KV1
XLCCN 3205 M 0616	25	32	150	6.00	60	0.17	G139	KV1

G136	LCM. 0316..
G137	LCM. 0416..
G138	LCM. 0516..
G139	LCM. 0616..

KV1	KV 5x100

**DU, D****Blocco porta lama per lame di troncatura**

Portautensile per adattare lame di troncatura GL o XLC. Disponibile nelle dimensioni 20x20 fino a 40x40 mm. Corpi trattati per una maggiore durata.

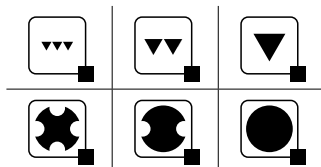
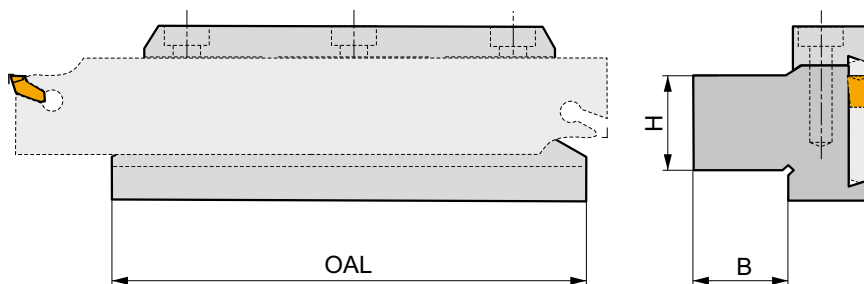
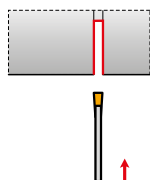

Codice prodotto	H (mm)	B (mm)	OAL (mm)	kg		
26-DU 2020	20	20	90	0.70	GI007	ND2
26-D 2020	20	20	100	0.82	GI007	ND2
32-DU 2523	25	23	110	1.02	GI008	ND2
32-DU 2532	25	32	110	1.10	GI008	ND2
32-DU 3229	32	29	110	1.25	GI008	ND2
32-D 2530	25	30	115	1.30	GI008	ND2
45-DU 3229	32	29	110	1.50	GI009	ND7
45-DU 4036	40	36	110	2.05	GI009	ND7
47-D 4040	40	40	150	3.88	GI091	ND3

GI007	XLC.N 26..	GL.-S26.B
GI008	XLC.N 32..	GL.-S32.B
GI009	XLC.N 45..	-
GI091	XLC.N 47..	-

ND2	HS 0625	6.0	M 6	25	HXK 5
ND3	HS 1030	8.0	M 10	30	HXK 8
ND7	HS 0630	6.0	M 6	30	HXK 5



XLCCN 25 BS



PRAMET

G



Lama per scanalature radiali per utensile modulare MS-EN e inserti LCM...

Lama modulare per scanalatura con inserti mono-tagliente o bi-taglienti LCM...0316, 0416, 0516 e 0616. Adatto per applicazioni di scanalatura o troncatura (profondità massima di taglio 25 mm). Sono adatti per utensili modulari MS-EN. Lama trattate per una maggiore durata.

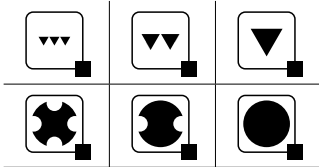
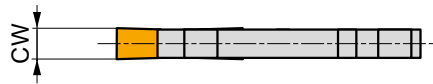
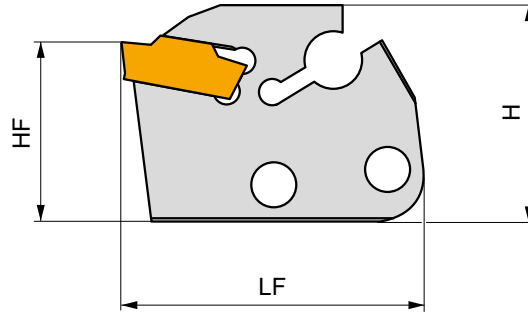
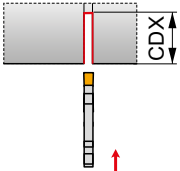

Codice prodotto	Ξ	H	LF	CW	CDX	kg		
	(mm)	(mm)	(mm)	(mm)	(mm)			
N XLCCN 250215-0316	24	29	40	3.00	15	0.01	G136	-
XLCCN 250225-0316	24	29	50	3.00	25	0.02	G136	-
XLCCN 250315-0416	24	29	40	4.00	15	0.04	G137	-
XLCCN 250325-0416	24	29	50	4.00	25	0.04	G137	-
XLCCN 250425-0516	24	29	50	5.00	25	0.03	G138	-
XLCCN 250525-0616	24	29	50	6.00	25	0.04	G139	-

G136	LCM. 0316..
G137	LCM. 0416..
G138	LCM. 0516..
G139	LCM. 0616..



MS-EN



Utensile Modulare per lame XLCCN, XLCF(NRL) o XLXFL

Portautensile per lame di Scanalatura assiale XLC25 BS, XLCF(NRL) BS, XLXFL BS. Disponibile nelle dimensioni 12x12 fino a 32x25 mm. Corpi trattati per una maggiore durata.

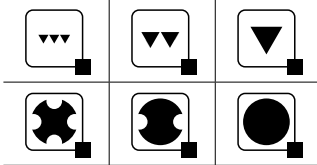
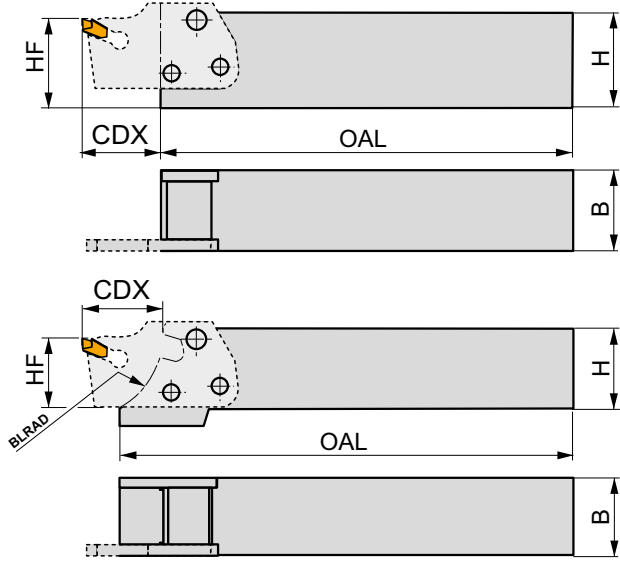
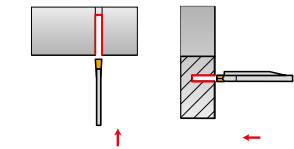

Codice prodotto	HF (mm)	H (mm)	B (mm)	OAL (mm)	CDX (mm)	BLRAD (mm)	kg		
MS-EN-1212 F	12	12	12	75	15	-	0.13	GI006	ND4
MS-EN-1616 H	16	16	16	90	15	-	0.21	GI006	ND4
MS-EN-2020 K	20	20	20	115	15	-	0.23	GI003	ND5
MS-EN-2020 KS	20	20	20	129	15	25	0.42	GI060	ND5
MS-EN-2525 M	25	25	25	140	15	-	0.65	GI003	ND5
MS-EN-2525 MS	25	25	25	153	15	25	0.74	GI060	ND5
MS-EN-3225 P	32	32	25	160	15	-	0.95	GI003	ND5
MS-EN-3225 PS	32	32	25	174	15	25	1.00	GI060	ND5

GI003	XLC.. 25..15...	XLXFL 25...	XLC.. 25..25...
GI006	XLCF. 16..15...	XLCF. 16..20...	-
GI060	XLC.. 25..15...	XLC.. 25..25...	-

ND4	US 4011-T15P	3.5	M 4	10.6	-	-	-	-	FLAG T15P
ND5	US 45013-T20P	5.0	M 5	13	US 46017-T20P	5.0	M6	17	FLAG T15P

ND4 = 3 x US 4011-T15P; ND5 = 2 x US 45013-T20P



GFIL-L AXIAL

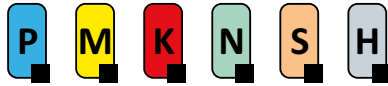

PRAMET

G



Utensile esterno per scanalatura frontale, staffa di bloccaggio a V, per inserti LCM. 03

Utensile esterno sinistro per scanalatura frontale con inserti LCM 0313 o 0316, mono o bi-taglienti. Adatto per applicazioni di scanalatura e profilatura frontale diametri da Ø17 a Ø170 mm con profondità massima di taglio 9 mm. Disponibile con misura stelo 25x25 mm. Corpo trattato per una maggiore durata dell'utensile.

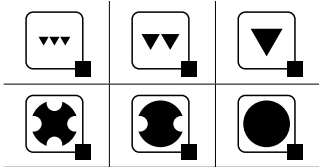
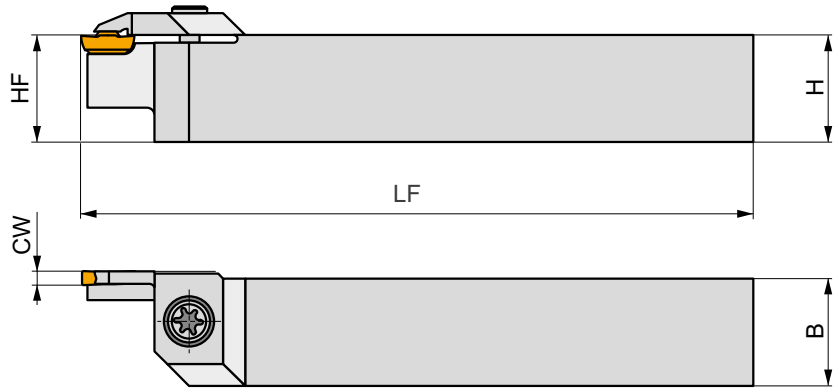
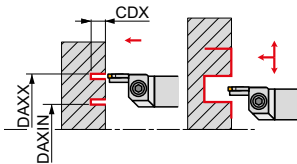

Codice prodotto	HF	H	B	LF	CW	CDX	DAXIN	DAXX	kg		
	(mm)	(mm)	(mm)	(mm)	(mm)	(mm)	(mm)				
GFIL 2525 M 0313L 030017	25	25	25	150	3.00	9	17	30	0.64	GI143	GL02
GFIL 2525 M 0313L 039024	25	25	25	150	3.00	9	24	39	0.66	GI143	GL07
GFIL 2525 M 0313L 050033	25	25	25	150	3.00	9	33	50	0.67	GI143	GL07
GFIL 2525 M 0313L 060043	25	25	25	150	3.00	9	43	60	0.67	GI143	GL07
GFIL 2525 M 0313L 076053	25	25	25	150	3.00	9	53	76	0.67	GI143	GL07
GFIL 2525 M 0316L 100070	25	25	25	150	3.00	9	70	100	0.69	GI136	GL07
GFIL 2525 M 0316L 130090	25	25	25	150	3.00	9	90	130	0.70	GI136	GL07
GFIL 2525 M 0316L 170110	25	25	25	150	3.00	9	110	170	0.71	GI136	GL07

GI136	LCM. 0316..
GI143	LCM. 0313..

GL02	US 5015-T20P	5.0	M 5	15	FLAG T20P
GL07	US 5018-T20P	5.0	M 5	18.2	FLAG T20P



GFIL-R AXIAL

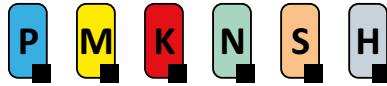

PRAMET

G



Utensile esterno per scanalatura frontale, staffa di bloccaggio a V, per inserti LCM. 03 / 04

Utensile esterno per scanalatura frontale, sinistro, con inserti LCM mono o bi-taglienti, dimensioni 0313, 0316, 0413 o 0416. Adatto per applicazioni di scanalatura e profilatura frontale, diametri da Ø17 a Ø230 mm, con profondità massima di taglio 12 mm. Disponibile con stelo 25x25. Corpo trattato per una maggiore durata dell'utensile.

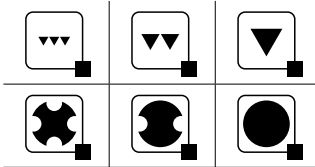
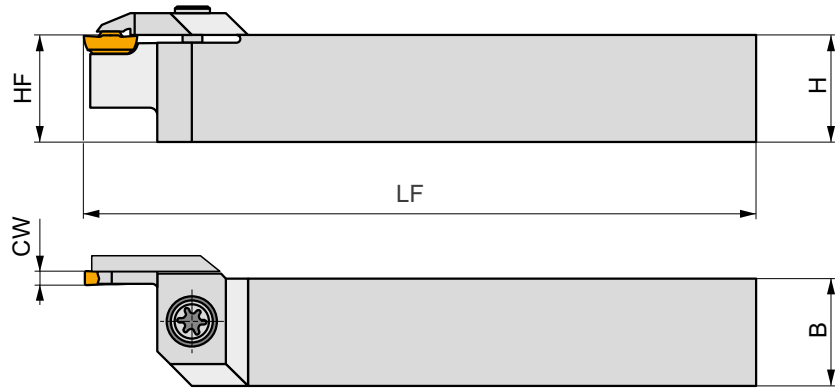
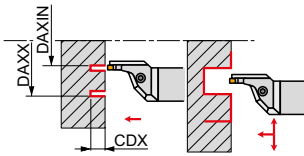

Codice prodotto	HF	H	B	LF	CW	CDX	DAXIN	DAXX	kg		
	(mm)	(mm)	(mm)	(mm)	(mm)	(mm)	(mm)				
L GFIL 2525 M 03R 030017-A	25	25	25	150	3.00	9	17	30	0.69	G1143	GL07
GFIL 2525 M 03R 039024-A	25	25	25	150	3.00	9	24	39	0.69	G1143	GL07
GFIL 2525 M 03R 050033-A	25	25	25	150	3.00	9	33	50	0.72	G1143	GL07
GFIL 2525 M 03R 060043-A	25	25	25	150	3.00	9	43	60	0.69	G1143	GL07
GFIL 2525 M 03R 076053-A	25	25	25	150	3.00	9	53	76	0.68	G1143	GL07
GFIL 2525 M 03R 100070-A	25	25	25	150	3.00	9	70	100	0.79	G1136	GL08
GFIL 2525 M 03R 130090-A	25	25	25	150	3.00	9	90	130	0.73	G1136	GL08
GFIL 2525 M 03R 170110-A	25	25	25	150	3.00	9	110	170	0.76	G1136	GL08
GFIL 2525 M 04R 030017-A	25	25	25	150	3.00	9	17	30	0.71	G1170	GL07
GFIL 2525 M 04R 034021-A	25	25	25	150	4.00	9	21	34	0.69	G1170	GL07
GFIL 2525 M 04R 040026-A	25	25	25	150	4.00	11	26	40	0.00	G1170	GL07
GFIL 2525 M 04R 050032-A	25	25	25	150	4.00	11	32	50	0.68	G1170	GL07
GFIL 2525 M 04R 060042-A	25	25	25	150	4.00	11	42	60	0.66	G1170	GL07
GFIL 2525 M 04R 075052-A	25	25	25	150	4.00	11	52	75	0.67	G1170	GL07
GFIL 2525 M 04R 100070-A	25	25	25	150	4.00	12	70	100	0.75	G1137	GL08
GFIL 2525 M 04R 130090-A	25	25	25	150	4.00	12	90	130	0.75	G1137	GL08
GFIL 2525 M 04R 170110-A	25	25	25	150	4.00	12	110	170	0.75	G1137	GL08
GFIL 2525 M 04R 230140-A	25	25	25	150	4.00	12	140	230	0.78	G1137	GL08



G1136
G1137
G1143
G1170

LCM. 0316..
LCM. 0416..
LCM. 0313..
LCM. 0413..



GL07
GL08

US 5018-T20P
US 6020-T25P

5.0
6.0

M 5
M 6

18.2
20.2

FLAG T20P
-

-
SDRT25P



GFIR-L AXIAL

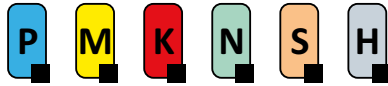

PRAMET

G



Utensile esterno per scanalatura frontale con staffa di bloccaggio a V per inserti LCM...03 o 04

Utensile esterno destro per scanalatura frontale con inserti mono o bi-taglienti LCM...0313, 0316, 0413 o 0416. Adatto per applicazioni di scanalatura frontale, profilatura o aperture di scanalature frontali da Ø17 a Ø230 mm, con profondità massima di taglio di 12 mm. Disponibile con stelo dimensione 25x25 mm. Corpo trattato per una maggiore durata.

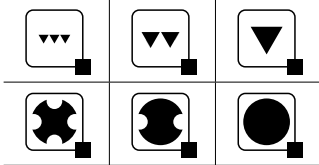
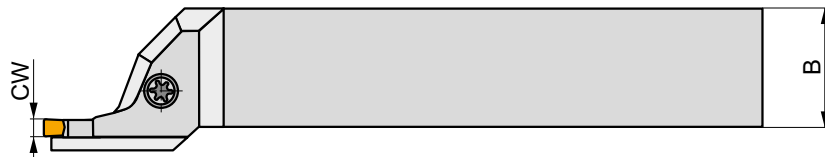
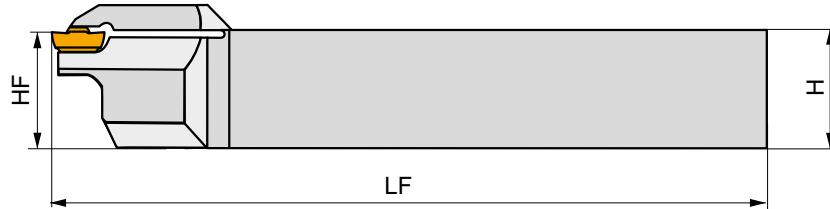
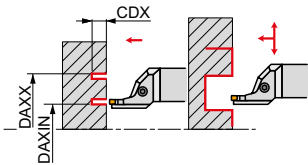

Codice prodotto	≡	H	B	LF	CW	CDX	DAXIN	DAXX	kg		
	(mm)	(mm)	(mm)	(mm)	(mm)	(mm)	(mm)	(mm)			
GFIR 2525 M 03L 030017-A	25	25	25	150	3.00	9	17	30	0.65	GI143	GL07
GFIR 2525 M 03L 039024-A	25	25	25	150	3.00	9	24	39	0.68	GI143	GL07
GFIR 2525 M 03L 050033-A	25	25	25	150	3.00	9	33	50	0.65	GI143	GL07
GFIR 2525 M 03L 060043-A	25	25	25	150	3.00	9	43	60	0.68	GI143	GL07
GFIR 2525 M 03L 076053-A	25	25	25	150	3.00	9	53	76	0.69	GI143	GL07
GFIR 2525 M 03L 100070-A	25	25	25	150	3.00	9	70	100	0.75	GI136	GL08
GFIR 2525 M 03L 130090-A	25	25	25	150	3.00	9	90	130	0.76	GI136	GL08
GFIR 2525 M 03L 170110-A	25	25	25	150	3.00	9	110	170	0.68	GI136	GL08
GFIR 2525 M 04L 030017-A	25	25	25	150	3.00	9	17	30	0.68	GI170	GL07
GFIR 2525 M 04L 034021-A	25	25	25	150	4.00	9	21	34	0.68	GI170	GL07
GFIR 2525 M 04L 040026-A	25	25	25	150	4.00	11	26	40	0.68	GI170	GL07
GFIR 2525 M 04L 050032-A	25	25	25	150	4.00	11	32	50	0.66	GI170	GL07
GFIR 2525 M 04L 060042-A	25	25	25	150	4.00	11	42	60	0.69	GI170	GL07
GFIR 2525 M 04L 075052-A	25	25	25	150	4.00	11	52	75	0.67	GI170	GL07
GFIR 2525 M 04L 100070-A	25	25	25	150	4.00	12	70	100	0.72	GI137	GL08
GFIR 2525 M 04L 130090-A	25	25	25	150	4.00	12	90	130	0.75	GI137	GL08
GFIR 2525 M 04L 170110-A	25	25	25	150	4.00	12	110	170	0.72	GI137	GL08
GFIR 2525 M 04L 230140-A	25	25	25	150	4.00	12	140	230	0.79	GI137	GL08

R



GI136
GI137
GI143
GI170

LCM. 0316..
LCM. 0416..
LCM. 0313..
LCM. 0413..



GL07
GL08

US 5018-T20P
US 6020-T25P

5.0
6.0

M 5
M 6

18.2
20.2

FLAG T20P
-

-
SDRT25P



GFIR-R AXIAL

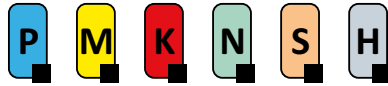

PRAMET

G



Utensile esterno per scanalatura frontale con staffa di bloccaggio a V per inserti LCM...03

Utensile esterno destro per scanalatura frontale con inserti mono o bi-taglienti LCM...0313 o 0316. Adatto per applicazioni di scanalatura frontale, profilatura o aperture di scanalature frontali da Ø17 a Ø170 mm, con profondità massima di taglio di 9 mm. Disponibile con stelo dimensione 25x25 mm. Corpo trattato per una maggiore durata.

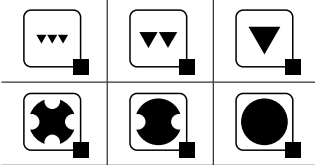
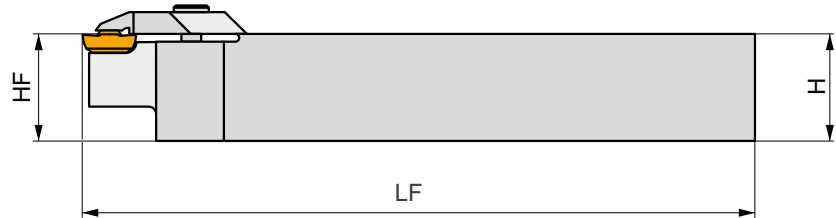
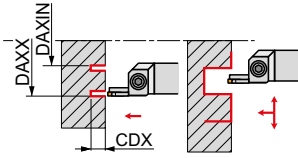

Codice prodotto	HF	H	B	LF	CW	CDX	DAXIN	DAXX	kg	Icona 1	Icona 2
	(mm)	(mm)	(mm)	(mm)	(mm)	(mm)	(mm)	(mm)			
R GFIR 2525 M 0313R 030017	25	25	25	150	3.00	9	17	30	0.65	GI143	GL02
GFIR 2525 M 0313R 039024	25	25	25	150	3.00	9	24	39	0.66	GI143	GL07
GFIR 2525 M 0313R 050033	25	25	25	150	3.00	9	33	50	0.68	GI143	GL07
GFIR 2525 M 0313R 060043	25	25	25	150	3.00	9	43	60	0.68	GI143	GL07
GFIR 2525 M 0313R 076053	25	25	25	150	3.00	9	53	76	0.68	GI143	GL07
GFIR 2525 M 0316R 100070	25	25	25	150	3.00	9	70	100	0.69	GI136	GL07
GFIR 2525 M 0316R 130090	25	25	25	150	3.00	9	90	130	0.70	GI136	GL07
GFIR 2525 M 0316R 170110	25	25	25	150	3.00	9	110	170	0.70	GI136	GL07



GI136
GI143

LCM. 0316..
LCM. 0313..



GL02
GL07

US 5015-T20P
US 5018-T20P

5.0
5.0

M 5
M 5

15
18.2

FLAG T20P
FLAG T20P



GFML-L AXIAL



PRAMET

G



Utensile esterno per scanalatura frontale, staffa di bloccaggio a V, per inserti LCM. 04

Utensile esterno sinistro per scanalatura frontale con inserti LCM mono o bi-taglienti, dimensioni 0413 o 0416. Adatto per applicazioni di scanalatura frontale profonda e profilatura su diametri da Ø17 a Ø230 mm, con profondità massima di taglio 20 mm. Disponibile con misura stelo 25x25 mm. Corpo trattato per una maggiore durata dell'utensile.

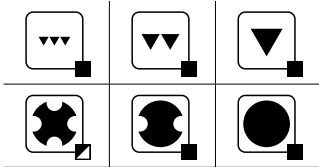
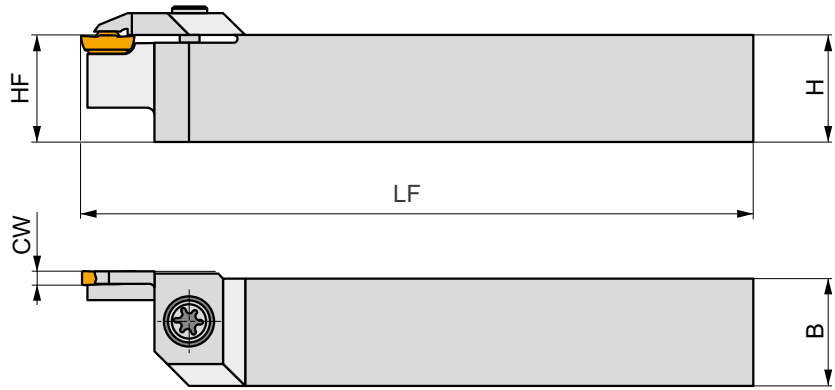
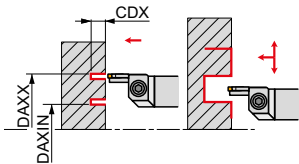

Codice prodotto	HF (mm)	H (mm)	B (mm)	LF (mm)	CW (mm)	CDX (mm)	DAXIN (mm)	DAXX (mm)	kg	GI	GL
GFML 2525 M 0413L 030017	25	25	25	150	4.00	20	17	30	0.62	GI170	GL02
GFML 2525 M 0413L 034021	25	25	25	150	4.00	20	21	34	0.63	GI170	GL07
GFML 2525 M 0413L 040026	25	25	25	150	4.00	20	26	40	0.65	GI170	GL07
GFML 2525 M 0413L 050032	25	25	25	150	4.00	20	32	50	0.64	GI170	GL07
GFML 2525 M 0413L 060042	25	25	25	150	4.00	20	42	60	0.65	GI170	GL07
GFML 2525 M 0413L 075052	25	25	25	150	4.00	20	52	75	0.66	GI170	GL07
GFML 2525 M 0416L 100070	25	25	25	150	4.00	20	70	100	0.66	GI137	GL07
GFML 2525 M 0416L 130090	25	25	25	150	4.00	20	90	130	0.67	GI137	GL07
GFML 2525 M 0416L 170110	25	25	25	150	4.00	20	110	170	0.67	GI137	GL07
GFML 2525 M 0416L 230140	25	25	25	150	4.00	20	140	230	0.67	GI137	GL07



GI137

LCM. 0416..

GI170

LCM. 0413..



GL02

US 5015-T20P

5.0

M 5

15

FLAG T20P

GL07

US 5018-T20P

5.0

M 5

18.2

FLAG T20P



GFML-R AXIAL

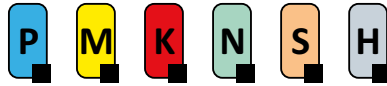

PRAMET

G



Utensile esterno per scanalatura frontale, staffa di bloccaggio a V, per inserti LCM. 04

Utensile esterno sinistro per scanalatura frontale con inserti LCM mono o bi-taglienti, dimensioni 0413 o 0416. Adatto per applicazioni di scanalatura frontale profonda e profilatura, diametri da Ø17 a Ø230 mm, con profondità massima di taglio 20 mm. Disponibile con misura stelo 25x25 mm. Corpo trattato per una maggiore durata dell'utensile.

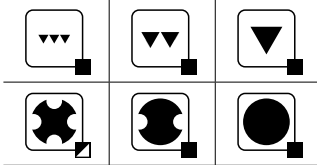
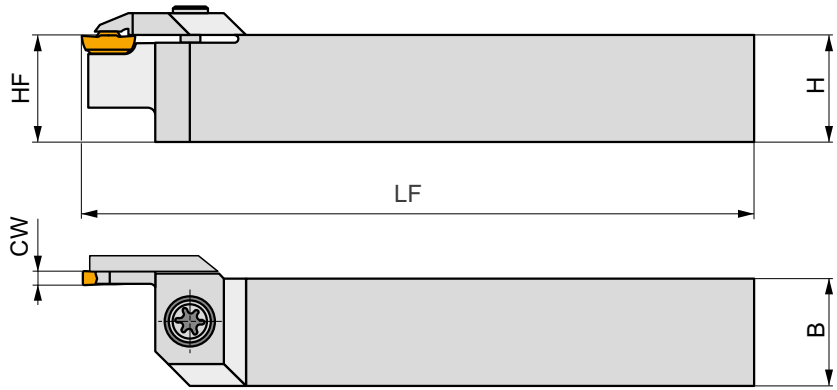
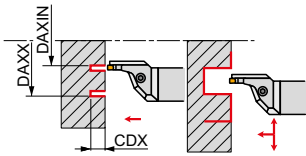

Codice prodotto	HF	H	B	LF	CW	CDX	DAXIN	DAXX	kg	G1	G2
	(mm)	(mm)	(mm)	(mm)	(mm)	(mm)	(mm)	(mm)			
GFML 2525 M 0413R 030017	25	25	25	150	4.00	20	17	30	0.68	G1170	GL07
GFML 2525 M 0413R 034021	25	25	25	150	4.00	20	21	34	0.69	G1170	GL07
GFML 2525 M 0413R 040026	25	25	25	150	4.00	20	26	40	0.69	G1170	GL07
GFML 2525 M 0413R 050032	25	25	25	150	4.00	20	32	50	0.68	G1170	GL07
GFML 2525 M 0413R 060042	25	25	25	150	4.00	20	42	60	0.69	G1170	GL07
GFML 2525 M 0413R 075052	25	25	25	150	4.00	20	52	75	0.69	G1170	GL07
GFML 2525 M 0416R 100070	25	25	25	150	4.00	20	70	100	0.80	G1137	GL08
GFML 2525 M 0416R 130090	25	25	25	150	4.00	20	90	130	0.78	G1137	GL08
GFML 2525 M 0416R 170110	25	25	25	150	4.00	20	110	170	0.78	G1137	GL08
GFML 2525 M 0416R 230140	25	25	25	150	4.00	20	140	230	0.78	G1137	GL08



G1137
G1170

LCM. 0416..
LCM. 0413..



GL07
GL08

US 5018-T20P
US 6020-T25P

5.0
6.0

M 5
M 6

18.2
20.2

FLAG T20P
-

-
SDRT25P



GFMR-L AXIAL

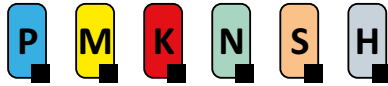

PRAMET

G



Utensile esterno per scanalatura frontale con staffa di bloccaggio a V per inserti LCM...04

Utensile esterno destro per scanalatura frontale con inserti LCM...0413 o 0416. Adatto per applicazioni di scanalatura frontale profonda, profilatura o aperture di scanalature frontali da Ø17 a Ø230 mm, con profondità massima di taglio di 20 mm. Disponibile con stelo dimensione 25x25 mm. Corpo trattato per una maggiore durata.

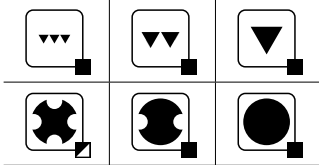
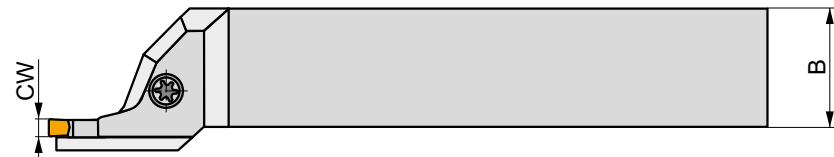
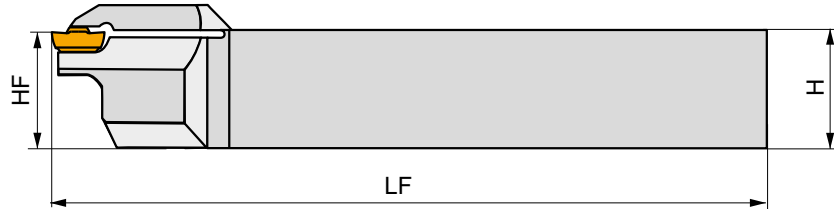
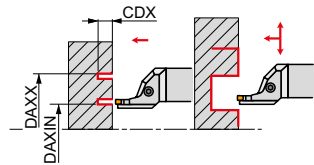

Codice prodotto	⌀	H	B	LF	CW	CDX	DAXIN	DAXX	kg		
	(mm)	(mm)	(mm)	(mm)	(mm)	(mm)	(mm)	(mm)			
GFMR 2525 M 0413L 030017	25	25	25	150	4.00	20	17	30	0.70	G1170	GL07
GFMR 2525 M 0413L 034021	25	25	25	150	4.00	20	21	34	0.66	G1170	GL07
GFMR 2525 M 0413L 040026	25	25	25	150	4.00	20	26	40	0.66	G1170	GL07
GFMR 2525 M 0413L 050032	25	25	25	150	4.00	20	32	50	0.68	G1170	GL07
GFMR 2525 M 0413L 060042	25	25	25	150	4.00	20	42	60	0.66	G1170	GL07
GFMR 2525 M 0413L 075052	25	25	25	150	4.00	20	52	75	0.69	G1170	GL07
GFMR 2525 M 0416L 100070	25	25	25	150	4.00	20	70	100	0.88	G1137	GL08
GFMR 2525 M 0416L 130090	25	25	25	150	4.00	20	90	130	0.78	G1137	GL08
GFMR 2525 M 0416L 170110	25	25	25	150	4.00	20	110	170	0.81	G1137	GL08
GFMR 2525 M 0416L 230140	25	25	25	150	4.00	20	140	230	0.78	G1137	GL08

G1137		LCM. 0416..	
G1170		LCM. 0413..	

GL07	US 5018-T20P	5.0	M 5	18.2	FLAG T20P	-
GL08	US 6020-T25P	6.0	M 6	20.2	-	SDR T25P



GFMR-R AXIAL

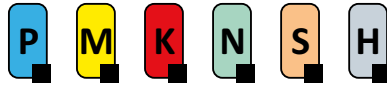

PRAMET

G



Utensile esterno di scanalatura frontale con staffa di bloccaggio a V per inserti LCM...04

Utensile esterno destro per scanalatura frontale con inserti LCM...0413 o 0416. Adatto per applicazioni di scanalatura frontale profonda, profilatura o aperture per scanalature frontali da Ø17 a Ø230 mm, con profondità massima di taglio di 20 mm. Disponibile con stelo dimensione 25x25 mm. Corpo trattato per una maggiore durata.

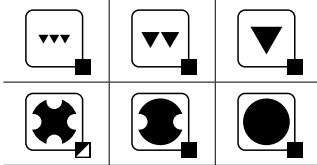
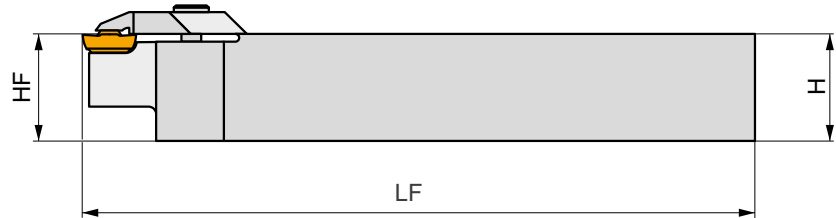
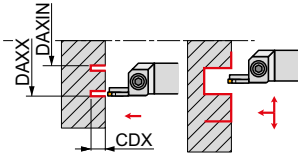

Codice prodotto	≡	H	B	LF	CW	CDX	DAXIN	DAXX	kg		
	(mm)	(mm)	(mm)	(mm)	(mm)	(mm)	(mm)	(mm)			
GFMR 2525 M 0413R 030017	25	25	25	150	4.00	20	17	30	0.62	G170	GL02
GFMR 2525 M 0413R 034021	25	25	25	150	4.00	20	21	34	0.63	G170	GL07
GFMR 2525 M 0413R 040026	25	25	25	150	4.00	20	26	40	0.64	G170	GL07
GFMR 2525 M 0413R 050032	25	25	25	150	4.00	20	32	50	0.63	G170	GL07
GFMR 2525 M 0413R 060042	25	25	25	150	4.00	20	42	60	0.64	G170	GL07
GFMR 2525 M 0413R 075052	25	25	25	150	4.00	20	52	75	0.67	G170	GL07
GFMR 2525 M 0416R 100070	25	25	25	150	4.00	20	70	100	0.67	G137	GL07
GFMR 2525 M 0416R 130090	25	25	25	150	4.00	20	90	130	0.66	G137	GL07
GFMR 2525 M 0416R 170110	25	25	25	150	4.00	20	110	170	0.67	G137	GL07
GFMR 2525 M 0416R 230140	25	25	25	150	4.00	20	140	230	0.68	G137	GL07



G137
G170

LCM. 0416..
LCM. 0413..



GL02
GL07

US 5015-T20P
US 5018-T20P

5.0
5.0

M 5
M 5

15
18.2

FLAG T20P
FLAG T20P



GGI(RL)-90 AXIAL

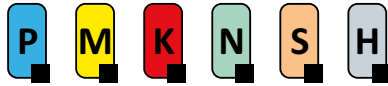

PRAMET

G



Utensile esterno a 90° per scanalatura frontale, staffa di bloccaggio a V, per inserti LCM.03

Utensile esterno a 90°, destro / sinistro, per scanalatura frontale con inserti LCM mono o bi-taglienti 0313 o 0316. Adatto per applicazioni di scanalatura frontale, profilatura o allargamento diametri da Ø17 a Ø170 mm, con profondità massima di taglio 11 mm. Disponibile con misura stelo 25x25 mm. Corpo trattato per una maggiore durata dell'utensile.

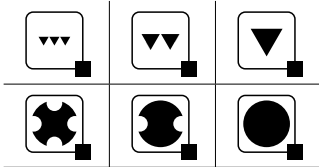
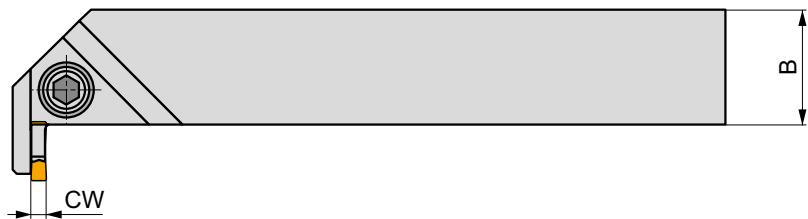
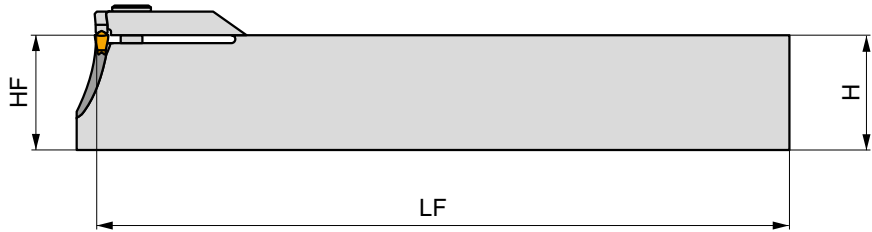
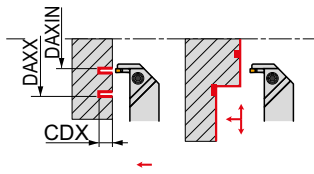

Codice prodotto	HF	H	B	LF	CW	CDX	DAXIN	DAXX	kg			
	(mm)	(mm)	(mm)	(mm)	(mm)	(mm)	(mm)	(mm)				
R	GGIR 2525 M 03R 030017	25	25	25	150	3.00	9.5	17	30	0.75	GI143	GL01
	GGIR 2525 M 03R 039024	25	25	25	150	3.00	9.5	24	39	0.78	GI143	GL01
	GGIR 2525 M 03R 050033	25	25	25	150	3.00	11	33	50	0.75	GI143	GL01
	GGIR 2525 M 03R 060043	25	25	25	150	3.00	11	43	60	0.78	GI143	GL01
	GGIR 2525 M 03R 076053	25	25	25	150	3.00	11	53	76	0.75	GI143	GL01
	GGIR 2525 M 03R 100070	25	25	25	150	3.00	9	70	100	0.78	GI136	GL04
	GGIR 2525 M 03R 130090	25	25	25	150	3.00	9	90	130	0.73	GI136	GL04
	GGIR 2525 M 03R 170110	25	25	25	150	3.00	9	110	170	0.76	GI136	GL04
L	GGIL 2525 M 03L 030017	25	25	25	150	3.00	9.5	17	30	0.75	GI143	GL01
	GGIL 2525 M 03L 039024	25	25	25	150	3.00	9.5	24	39	0.25	GI143	GL01
	GGIL 2525 M 03L 050033	25	25	25	150	3.00	11	33	50	0.75	GI143	GL01
	GGIL 2525 M 03L 060043	25	25	25	150	3.00	11	43	60	0.75	GI143	GL01
	GGIL 2525 M 03L 076053	25	25	25	150	3.00	11	53	76	0.75	GI143	GL01
	GGIL 2525 M 03L 100070	25	25	25	150	3.00	9	70	100	0.77	GI136	GL04
	GGIL 2525 M 03L 130090	25	25	25	150	3.00	9	90	130	0.77	GI136	GL04
	GGIL 2525 M 03L 170110	25	25	25	150	3.00	9	110	170	0.76	GI136	GL04

GI136	LCM. 0316..
GI143	LCM. 0313..

GL01	HS 0520C	5.0	M 5	20	HXK 4
GL04	HS 0620C	6.0	M 6	20	HXK 5

LCMF 20 - F1

	CW	CWTOLL	CWTOLU	INSL
	(mm)	(mm)	(mm)	(mm)
0220	2.00	-0.03	0.03	19.5

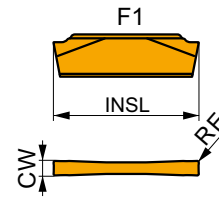

Idoneità e valori iniziali per velocità di taglio (Vc) e avanzamento (f). Fare riferimento alla nostra App Machining Calculator per ulteriori calcoli.

Codice prodotto	RE (mm)	P		M		K		N		S		H		PSIRR (°)	PSIRL (°)
		vc (m/min)	f (mm/rev)	vc (m/min)	f (mm/rev)	vc (m/min)	f (mm/rev)	vc (m/min)	f (mm/rev)	vc (m/min)	f (mm/rev)	vc (m/min)	f (mm/rev)		

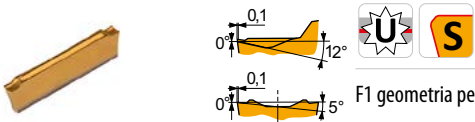

F1 geometria per operazioni di troncatura e scanalatura, adatto per lavorazioni leggere e finitura, da taglio continuo a leggermente interrotto.

LCMF 022002-F1	T8330	0.2	205	0.09	120	0.08	190	0.09	-	-	-	-	-	-	-
----------------	-------	-----	-----	------	-----	------	-----	------	---	---	---	---	---	---	---

LCMF 20 - M2

	CW	CWTOLL	CWTOLU	INSL
	(mm)	(mm)	(mm)	(mm)
0220	2.00	-0.03	0.03	19.5

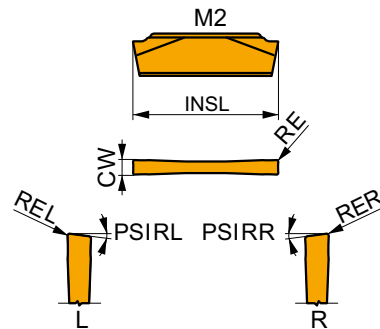

Idoneità e valori iniziali per velocità di taglio (Vc) e avanzamento (f). Fare riferimento alla nostra App Machining Calculator per ulteriori calcoli.

Codice prodotto	RE (mm)	P		M		K		N		S		H		PSIRR (°)	PSIRL (°)
		vc (m/min)	f (mm/rev)	vc (m/min)	f (mm/rev)	vc (m/min)	f (mm/rev)	vc (m/min)	f (mm/rev)	vc (m/min)	f (mm/rev)				

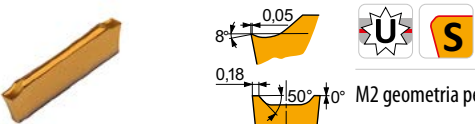

M2 geometria per operazioni di troncatura e scanalatura, per lavorazioni leggere e finitura, da taglio continuo a leggermente interrotto.

LCMF 022002-M2	T8330	0.2	180	0.12	105	0.11	170	0.12	-	-	-	-	-	-	-
----------------	-------	-----	-----	------	-----	------	-----	------	---	---	---	---	---	---	---

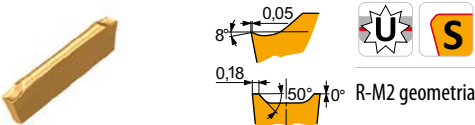

R-M2 geometria destra, per operazioni di troncatura, da taglio continuo a leggermente interrotto.

LCMF 022002R6-M2	T8330	0.2	130	0.12	75	0.11	120	0.12	-	-	-	-	6	-
------------------	-------	-----	-----	------	----	------	-----	------	---	---	---	---	---	---

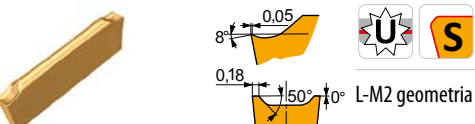

L-M2 geometria sinistra, per operazioni di troncatura, da taglio continuo a leggermente interrotto.

LCMF 022002L6-M2	T8330	0.2	130	0.12	75	0.11	120	0.12	-	-	-	-	-	6
------------------	-------	-----	-----	------	----	------	-----	------	---	---	---	---	---	---

LCMF 20 - MP

	CW	CWTOLL	CWTOLU	INSL
	(mm)	(mm)	(mm)	(mm)
0220	2.00	-0.03	0.03	19.5

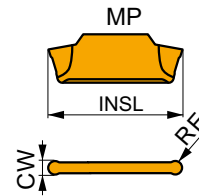

Idoneità e valori iniziali per velocità di taglio (Vc), avanzamento (f) e profondità di taglio (ap). Fare riferimento alla nostra App Machining Calculator per ulteriori calcoli.

Codice prodotto	RE (mm)	P			M			K			N			S			H		
		vc (m/min)	f (mm/rev)	ap (mm)	vc (m/min)	f (mm/rev)	ap (mm)	vc (m/min)	f (mm/rev)	ap (mm)	vc (m/min)	f (mm/rev)	ap (mm)	vc (m/min)	f (mm/rev)	ap (mm)	vc (m/min)	f (mm/rev)	ap (mm)

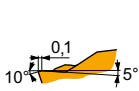

MP geometria per operazioni di tornitura longitudinale e copiatura, per lavorazioni leggere e finitura, da taglio continuo a interrotto.

LCMF 0220MO-MP	T8330	1.0	200	0.30	0.5	120	0.27	0.5	190	0.30	0.5	-	-	-	-	-	-	-
----------------	-------	-----	-----	------	-----	-----	------	-----	-----	------	-----	---	---	---	---	---	---	---

GFK(RL) EXT



PRAMET

G



Utensile esterno per scanalatura e taglio, staffa di bloccaggio a V, per inserti LCMF 0220

Utensile esterno destro / sinistro per scanalatura con inserti LCMF 0220. Adatto per applicazioni di troncatura, scanalatura e profilatura fino a una profondità di taglio massima di 16 mm. Disponibile con dimensioni stelo da 16x16 fino a 25x25 mm. Corpo trattato per una maggiore durata dell'utensile.

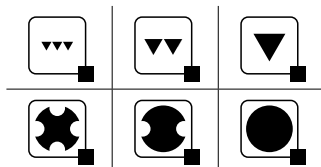
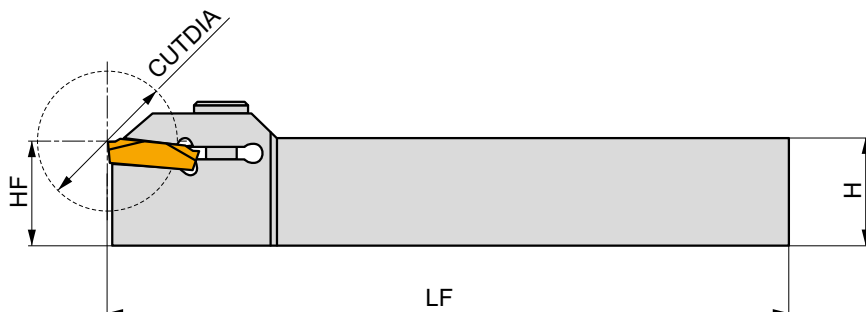
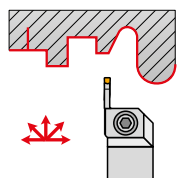

Codice prodotto	≡	H	B	LF	CW	CUTDIA	kg		
	(mm)	(mm)	(mm)	(mm)	(mm)	(mm)			
R	GFKR 1616 H 02	16	16	100	2.00	32	0.20	G1168	GL03
	GFKR 2020 K 02	20	20	125	2.00	32	0.38	G1168	GL04
	GFKR 2525 M 02	25	25	150	2.00	32	0.68	G1168	GL05
L	GFKL 1616 H 02	16	16	100	2.00	32	0.20	G1168	GL03
	GFKL 2020 K 02	20	20	125	2.00	32	0.38	G1168	GL04
	GFKL 2525 M 02	25	25	150	2.00	32	0.68	G1168	GL05



G1168



LCMF 0220..

GL03	HS 0616C	6.0	M 6	16	HXK 5
GL04	HS 0620C	6.0	M 6	20	HXK 5
GL05	HS 0625C	6.0	M 6	25	HXK 5

LFMX - F1

	CW	CWTOLL	CWTOLU	BW
	(mm)	(mm)	(mm)	(mm)
1.5	1.50	-0.03	0.03	1.30
1.6	1.60	-0.03	0.03	1.30
2.0	2.00	-0.03	0.03	1.60
3.1	3.10	-0.04	0.04	2.60
4.1	4.10	-0.04	0.04	3.60

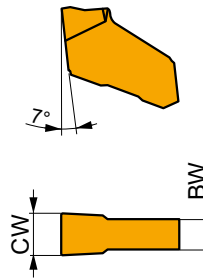

Idoneità e valori iniziali per velocità di taglio (Vc) e avanzamento (f). Fare riferimento alla nostra App Machining Calculator per ulteriori calcoli.

Codice prodotto	RE	P		M		K		N		S		H		PSIRR	PSIRL
		vc	f	vc	f	vc	f	vc	f	vc	f	vc	f		
	(mm)	(m/min)	(mm/rev)	(m/min)	(mm/rev)	(m/min)	(mm/rev)	(m/min)	(mm/rev)	(m/min)	(mm/rev)	(m/min)	(mm/rev)	(°)	(°)



EN-F1 geometria per operazioni di troncatura e scanalatura, taglio continuo.

LFMX 1.5-.16ENF1	T8330	0.2	130	0.08	75	0.07	120	0.08	-	-	-	-	-	-	-
LFMX 1.6-.16ENF1	T8330	0.2	130	0.08	75	0.07	120	0.08	-	-	-	-	-	-	-
LFMX 2.0-.16ENF1	T8330	0.2	130	0.08	75	0.07	120	0.08	-	-	-	-	-	-	-
LFMX 3.1-.20ENF1	T8330	0.2	130	0.10	75	0.09	120	0.10	-	-	-	-	-	-	-
LFMX 4.1-.20ENF1	T8330	0.2	130	0.10	75	0.09	120	0.10	-	-	-	-	-	-	-

LFMX - F2

	CW	CWTOLL	CWTOLU	BW
	(mm)	(mm)	(mm)	(mm)
1.6	1.60	-0.03	0.03	1.30
2.0	2.00	-0.03	0.03	1.60
3.1	3.10	-0.04	0.04	2.60
4.1	4.10	-0.04	0.04	3.60
5.1	5.10	-0.04	0.04	4.60
6.35	6.35	-0.04	0.04	5.80

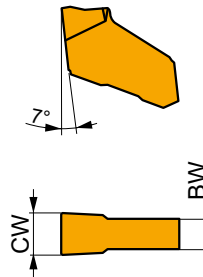

Idoneità e valori iniziali per velocità di taglio (Vc) e avanzamento (f). Fare riferimento alla nostra App Machining Calculator per ulteriori calcoli.

Codice prodotto	RE	P		M		K		N		S		H		PSIRR	PSIRL
		vc	f	vc	f	vc	f	vc	f	vc	f	vc	f		
	(mm)	(m/min)	(mm/rev)	(m/min)	(mm/rev)	(m/min)	(mm/rev)	(m/min)	(mm/rev)	(m/min)	(mm/rev)	(m/min)	(mm/rev)	(°)	(°)

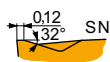

SN-F2 geometria adatta per operazioni di troncatura e scanalatura, taglio continuo.

LFMX 1.6-.16SNF2	T8330	0.2	130	0.10	75	0.09	120	0.10	-	-	-	-	-	-	-
LFMX 2.0-.16SNF2	6640	0.2	150	0.10	90	0.09	140	0.10	-	-	-	-	-	-	-
	T8330	0.2	130	0.10	75	0.09	120	0.10	-	-	-	-	-	-	-
LFMX 3.1-.20SNF2	6640	0.2	150	0.10	90	0.09	140	0.10	-	-	-	-	-	-	-
	T8330	0.2	130	0.10	75	0.09	120	0.10	-	-	-	-	-	-	-
LFMX 4.1-.20SNF2	T8330	0.2	130	0.12	75	0.11	120	0.12	-	-	-	-	-	-	-
LFMX 5.1-.20SNF2	T8330	0.2	130	0.12	75	0.11	120	0.12	-	-	-	-	-	-	-
LFMX 6.35-.20SNF2	T8330	0.2	130	0.15	75	0.14	120	0.15	-	-	-	-	-	-	-

Idoneità e valori iniziali per velocità di taglio (Vc) e avanzamento (f). Fare riferimento alla nostra App Machining Calculator per ulteriori calcoli.

Codice prodotto	RE (mm)	P		M		K		N		S		H		PSIRR (°)	PSIRL (°)
		vc (m/min)	f (mm/rev)	vc (m/min)	f (mm/rev)	vc (m/min)	f (mm/rev)	vc (m/min)	f (mm/rev)	vc (m/min)	f (mm/rev)	vc (m/min)	f (mm/rev)		

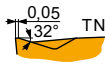

TN-F2 geometria per operazioni di troncatura e scanalatura, taglio continuo.

LFMX 3.1-.20TNF2	6640	0.2	150	0.10	90	0.09	140	0.10	-	-	-	-	-	-	-
	T8330	0.2	130	0.10	75	0.09	120	0.10	-	-	-	-	-	-	-
LFMX 4.1-.20TNF2	T8330	0.2	130	0.12	75	0.11	120	0.12	-	-	-	-	-	-	-

LFMX - M2



	CW (mm)	CWTOLL (mm)	CWTOLU (mm)	BW (mm)
2.0	2.00	-0.03	0.03	1.60
2.2	2.20	-0.03	0.03	1.60
3.1	3.10	-0.04	0.04	2.60
4.1	4.10	-0.04	0.04	3.60
5.1	5.10	-0.04	0.04	4.60
6.35	6.35	-0.04	0.04	5.80

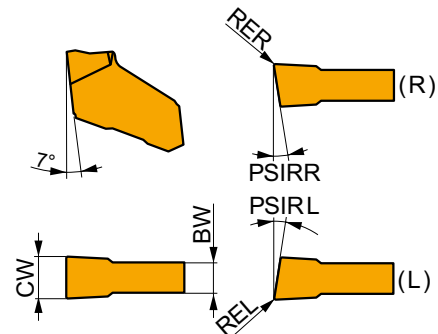

Idoneità e valori iniziali per velocità di taglio (Vc) e avanzamento (f). Fare riferimento alla nostra App Machining Calculator per ulteriori calcoli.

Codice prodotto	RE (mm)	P		M		K		N		S		H		PSIRR (°)	PSIRL (°)
		vc (m/min)	f (mm/rev)	vc (m/min)	f (mm/rev)	vc (m/min)	f (mm/rev)	vc (m/min)	f (mm/rev)	vc (m/min)	f (mm/rev)	vc (m/min)	f (mm/rev)		

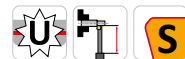
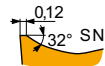

SN-M2 geometria adatta per operazioni di troncatura e scanalatura, da taglio continuo a leggermente interrotto.

LFMX 2.0-.16SNM2	6640	0.2	150	0.11	90	0.10	140	0.11	-	-	-	-	-	-	-
	T8330	0.2	130	0.11	75	0.10	120	0.11	-	-	-	-	-	-	-
LFMX 2.2-.16SNM2	6640	0.2	150	0.11	90	0.10	140	0.11	-	-	-	-	-	-	-
	T8330	0.2	130	0.11	75	0.10	120	0.11	-	-	-	-	-	-	-
LFMX 3.1-.20SNM2	6640	0.2	150	0.15	90	0.14	140	0.15	-	-	-	-	-	-	-
	T8330	0.2	130	0.15	75	0.14	120	0.15	-	-	-	-	-	-	-
LFMX 4.1-.20SNM2	6640	0.2	150	0.15	90	0.14	140	0.15	-	-	-	-	-	-	-
	T8330	0.2	130	0.15	75	0.14	120	0.15	-	-	-	-	-	-	-
LFMX 5.1-.20SNM2	6640	0.2	150	0.20	90	0.18	140	0.20	-	-	-	-	-	-	-
	T8330	0.2	130	0.20	75	0.18	120	0.20	-	-	-	-	-	-	-
LFMX 6.35-.20SNM2	6640	0.2	150	0.20	90	0.18	140	0.20	-	-	-	-	-	-	-
	T8330	0.2	130	0.20	75	0.18	120	0.20	-	-	-	-	-	-	-

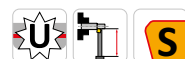
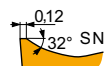
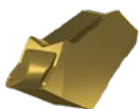

SR-M2 geometria destra, per operazioni di troncatura, da taglio continuo a leggermente interrotto.

LFMX 2.0-.16SR12M2	T8330	0.2	130	0.09	75	0.08	120	0.09	-	-	-	-	12	-
LFMX 2.0-.16SR6M2	T8330	0.2	130	0.09	75	0.08	120	0.09	-	-	-	-	6	-
LFMX 3.1-.20SR8M2	T8330	0.2	130	0.11	75	0.10	120	0.11	-	-	-	-	8	-
LFMX 4.1-.20SR8M2	T8330	0.2	130	0.15	75	0.14	120	0.15	-	-	-	-	8	-

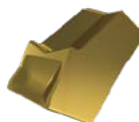

SL-M2 geometria sinistra, per operazioni di troncatura, da taglio continuo a leggermente interrotto.

LFMX 2.0-.16SL12M2	T8330	0.2	130	0.09	75	0.08	120	0.09	-	-	-	-	-	12
LFMX 2.0-.16SL6M2	T8330	0.2	130	0.09	75	0.08	120	0.09	-	-	-	-	-	6

Ideoneità e valori iniziali per velocità di taglio (Vc) e avanzamento (f). Fare riferimento alla nostra App Machining Calculator per ulteriori calcoli.

Codice prodotto	RE (mm)	P		M		K		N		S		H		PSIRR (°)	PSIRL (°)
		vc (m/min)	f (mm/rev)	vc (m/min)	f (mm/rev)	vc (m/min)	f (mm/rev)	vc (m/min)	f (mm/rev)	vc (m/min)	f (mm/rev)	vc (m/min)	f (mm/rev)		

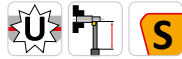
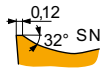
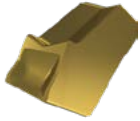

SL-M2 geometria sinistra, per operazioni di troncatura, da taglio continuo a leggermente interrotto.

LFMX 3.1-.20SL8M2	T8330	0.2	130	0.11	75	0.10	120	0.11	-	-	-	-	-	-	8
LFMX 4.1-.20SL8M2	T8330	0.2	130	0.15	75	0.14	120	0.15	-	-	-	-	-	-	8

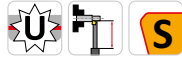
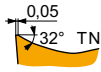

TN-M2 geometria per operazioni di troncatura e scanalatura, da taglio continuo a leggermente interrotto.

LFMX 3.1-.20TNM2	6640	0.2	150	0.15	90	0.14	140	0.15	-	-	-	-	-	-	-
	T8330	0.2	130	0.15	75	0.14	120	0.15	-	-	-	-	-	-	-
LFMX 4.1-.20TNM2	6640	0.2	150	0.15	90	0.14	140	0.15	-	-	-	-	-	-	-
	T8330	0.2	130	0.15	75	0.14	120	0.15	-	-	-	-	-	-	-

XLCFN B



PRAMET



Lama da troncatura a doppio lato per inserti LFMX

Lama per applicazioni di troncatura fino a una profondità massima di 80 mm o barra Ø160 mm. Adatta per inserti LFMX mono-taglienti. Disponibile nelle altezze 26, 32 o 45 mm. Può essere alloggiata nei supporti base DU Pramet. Lama trattata per una maggiore durata.

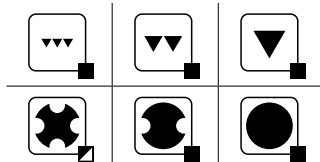
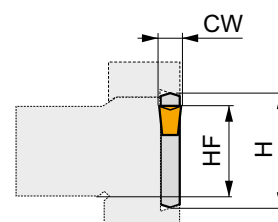
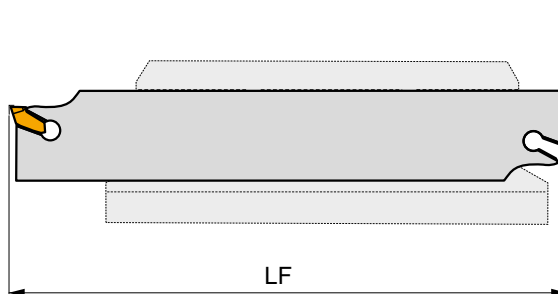
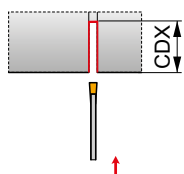

Codice prodotto	⌀	H	LF	CW	CDX	kg			
	(mm)	(mm)	(mm)	(mm)	(mm)				
N	XLCFN 2601 J 1.60	21.4	26	110	1.50	15	0.03	GI132	KV
	XLCFN 2601 J 2.00	21.4	26	110	2.00	25	0.04	GI061	KV
	XLCFN 2602 J 3.00	21.4	26	110	3.10	37.5	0.05	GI001	KV
	XLCFN 2603 J 4.00	21.4	26	110	4.10	40	0.06	GI002	KV
	XLCFN 3201 M 1.60	25	32	150	1.50	15	0.06	GI132	KV
	XLCFN 3201 M 2.00	25	32	150	2.00	25	0.11	GI061	KV
	XLCFN 3202 M 3.00	25	32	150	3.10	50	0.08	GI001	KV
	XLCFN 3203 M 4.00	25	32	150	4.10	50	0.11	GI002	KV
	XLCFN 3204 M 5.00	25	32	150	5.10	60	0.14	GI004	KV
	XLCFN 3205 M 6.35	25	32	150	6.35	60	0.17	GI005	KV
	XLCFN 4502 S 3.00	32	45	250	3.10	80	0.12	GI001	KV
	XLCFN 4503 S 4.00	32	45	250	4.10	80	0.19	GI002	KV
	XLCFN 4504 S 5.00	32	45	250	5.10	80	0.28	GI004	KV
	XLCFN 4505 S 6.35	32	45	250	6.35	80	0.40	GI005	KV

GI001	LFMX 3.1-.
GI002	LFMX 4.1-.
GI004	LFMX 5.1-.
GI005	LFMX 6.35-.
GI061	LFMX 2.0-.
GI132	LFMX 1.5-.

KV	KV 5x70



Blocco porta lama per lame di troncatura

Portautensile per adattare lame di troncatura GL o XLC. Disponibile nelle dimensioni 20x20 fino a 40x40 mm. Corpi trattati per una maggiore durata.

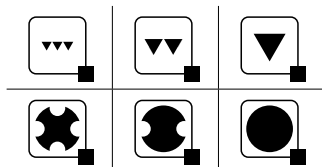
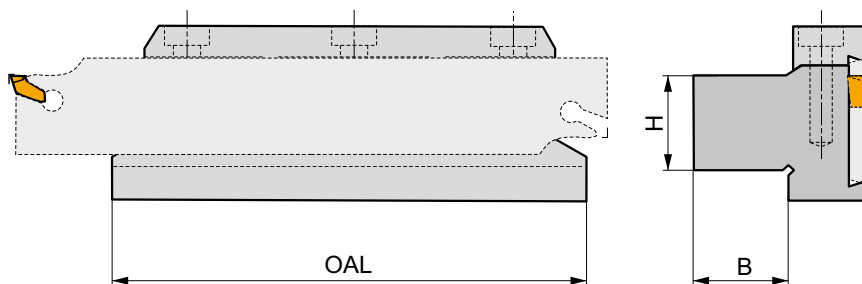
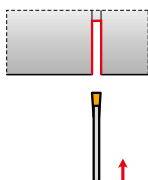

Codice prodotto	H (mm)	B (mm)	OAL (mm)	kg		
26-DU 2020	20	20	90	0.70	GI007	ND2
26-D 2020	20	20	100	0.82	GI007	ND2
32-DU 2523	25	23	110	1.02	GI008	ND2
32-DU 2532	25	32	110	1.10	GI008	ND2
32-DU 3229	32	29	110	1.25	GI008	ND2
32-D 2530	25	30	115	1.30	GI008	ND2
45-DU 3229	32	29	110	1.50	GI009	ND7
45-DU 4036	40	36	110	2.05	GI009	ND7
47-D 4040	40	40	150	3.88	GI091	ND3

GI007	XLC.N 26..	GL.-S26.B
GI008	XLC.N 32..	GL.-S32.B
GI009	XLC.N 45..	-
GI091	XLC.N 47..	-

ND2	HS 0625	6.0	M 6	25	HXX 5
ND3	HS 1030	8.0	M 10	30	HXX 8
ND7	HS 0630	6.0	M 6	30	HXX 5

XLCF(NRL) BS

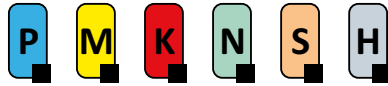

PRAMET



Lama per scanalature radiali per utensile modulare MS-EN e inserti LFMX

Lama modulare per scanalatura con inserti mono-taglienti LFMX. Adatta per applicazioni di scanalatura o troncatura (profondità massima di taglio 25 mm). Lame trattate per una maggiore durata.

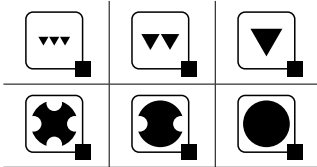
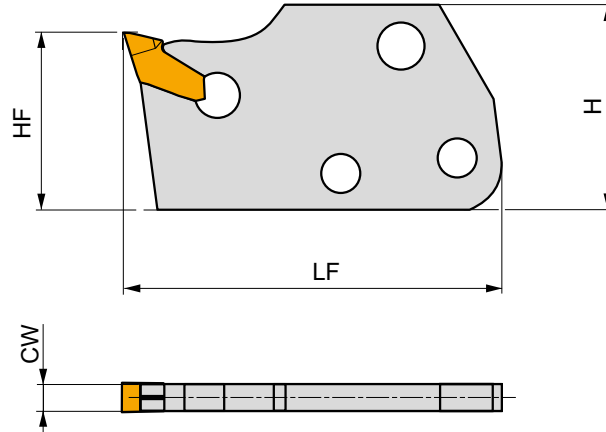
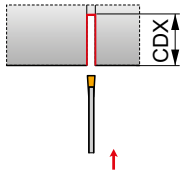

Codice prodotto	H	H	LF	CW	CDX	kg			
	(mm)	(mm)	(mm)	(mm)	(mm)				
R	XLCFR 160115-1.60	12	25	35	1.50	15	0.01	GI132	KV
	XLCFR 160115-2.00	12	25	35	2.00	15	0.01	GI061	KV
	XLCFR 250115-1.60	24	29	40	1.50	15	0.01	GI132	KV
	XLCFR 250115-2.00	24	29	40	2.00	15	0.05	GI061	KV
L	XLCFL 160115-1.60	12	25	35	1.50	15	0.01	GI132	KV
	XLCFL 160115-2.00	12	25	35	2.00	15	0.04	GI061	KV
	XLCFL 250115-1.60	24	29	40	1.50	15	0.01	GI132	KV
	XLCFL 250115-2.00	24	29	40	2.00	15	0.05	GI061	KV
N	XLCFN 160215-3.00	12	25	35	3.10	15	0.01	GI001	KV
	XLCFN 160220-3.00	12	25	40	3.10	20	0.02	GI001	KV
	XLCFN 250215-3.00	24	29	40	3.10	15	0.02	GI001	KV
	XLCFN 250225-3.00	24	29	50	3.10	25	0.02	GI001	KV
	XLCFN 250315-4.00	24	29	40	4.10	15	0.02	GI002	KV
	XLCFN 250325-4.00	24	29	50	4.10	25	0.03	GI002	KV
	XLCFN 250425-5.00	24	29	50	5.10	25	0.04	GI004	KV
	XLCFN 250525-6.35	24	29	50	6.35	25	0.04	GI005	KV

GI001	LFMX 3.1.-.	-
GI002	LFMX 4.1.-.	-
GI004	LFMX 5.1.-.	-
GI005	LFMX 6.35.-.	-
GI061	LFMX 2.0.-.	LFMX 2.2.-.
GI132	LFMX 1.5.-.	LFMX 1.6.-.

KV	KV 5x70

XLXFL BS AXIAL

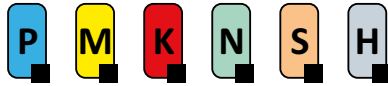

PRAMET



Lama per scanalature assiali per utensile modulare MS-EN e inserti LFMX

Lama modulare di scanalatura con inserti mono-taglienti LFMX 3.1. Adatta per applicazioni di scanalature assiali (massima profondità di taglio 20 mm). Sono adatte per utensili modulari MS-EN. Lame trattate per una maggiore durata.

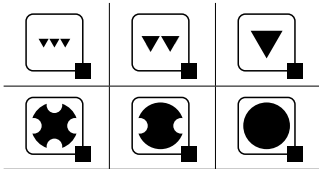
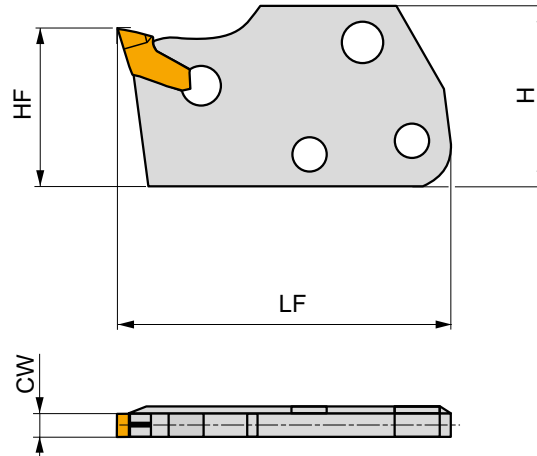
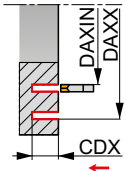

Codice prodotto	H	HF	LF	CW	CDX	DAXIN	DAXX	kg		
	(mm)	(mm)	(mm)	(mm)	(mm)	(mm)	(mm)			
XLXFL 250220-3.00-60	29	24	46	3.10	20	60	85	0.07	G1001	KV
XLXFL 250220-3.00-80	29	24	46	3.10	20	80	105	0.05	G1001	KV
XLXFL 250220-3.00-100	29	24	46	3.10	20	100	155	0.03	G1001	KV
XLXFL 250220-3.00-150	29	24	46	3.10	20	150	280	0.03	G1001	KV



G1001



LFMX 3.1-



KV



KV 5x70



Utensile Modulare per lame XLCCN, XLCF(NRL) o XLXFL

Portautensile per lame di Scanalatura assiale XLC25 BS, XLCF(NRL) BS, XLXFL BS. Disponibile nelle dimensioni 12x12 fino a 32x25 mm. Corpi trattati per una maggiore durata.

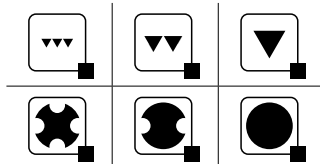
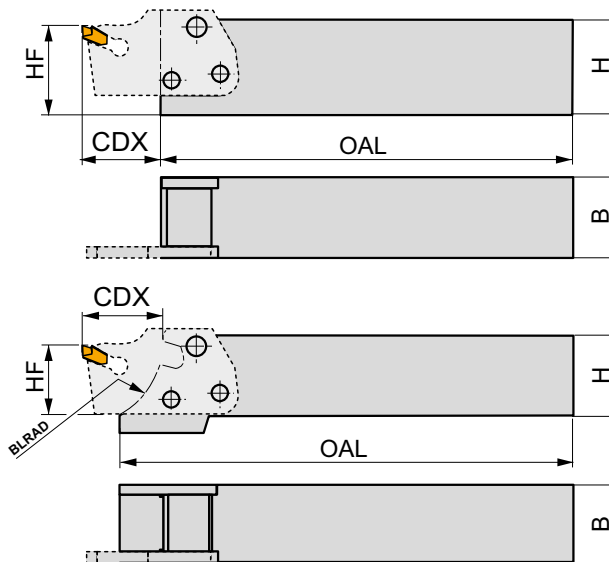
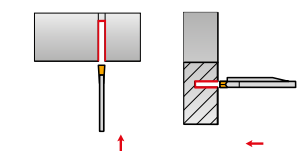

Codice prodotto	HF (mm)	H (mm)	B (mm)	OAL (mm)	CDX (mm)	BLRAD (mm)	kg		
MS-EN-1212 F	12	12	12	75	15	-	0.13	GI006	ND4
MS-EN-1616 H	16	16	16	90	15	-	0.21	GI006	ND4
MS-EN-2020 K	20	20	20	115	15	-	0.23	GI003	ND5
MS-EN-2020 KS	20	20	20	129	15	25	0.42	GI060	ND5
MS-EN-2525 M	25	25	25	140	15	-	0.65	GI003	ND5
MS-EN-2525 MS	25	25	25	153	15	25	0.74	GI060	ND5
MS-EN-3225 P	32	32	25	160	15	-	0.95	GI003	ND5
MS-EN-3225 PS	32	32	25	174	15	25	1.00	GI060	ND5

GI003	XLC.. 25..15...	XLXFL 25...	XLC.. 25..25...
GI006	XLCF. 16..15...	XLCF. 16..20...	-
GI060	XLC.. 25..15...	XLC.. 25..25...	-

ND4	US 4011-T15P	3.5	M 4	10.6	-	-	-	-	FLAG T15P
ND5	US 45013-T20P	5.0	M 5	13	US 46017-T20P	5.0	M6	17	FLAG T15P

ND4 = 3 x US 4011-T15P; ND5 = 2 x US 45013-T20P

LFUX

	CW	BW	INSL
	(mm)	(mm)	(mm)
0308	3.00	2.51	11.5
0408	4.00	3.44	11.5
0508	5.00	4.30	11.5
0608	6.00	5.30	11.5

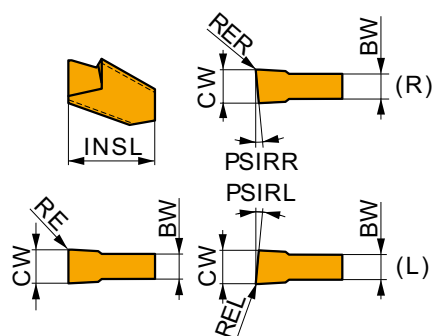

Idoneità e valori iniziali per velocità di taglio (Vc) e avanzamento (f). Fare riferimento alla nostra App Machining Calculator per ulteriori calcoli.

Codice prodotto	RE	P		M		K		N		S		H		PSIRR	PSIRL
		vc	f	vc	f	vc	f	vc	f	vc	f	vc	f		
	(mm)	(m/min)	(mm/rev)	(m/min)	(mm/rev)	(m/min)	(mm/rev)	(m/min)	(mm/rev)	(m/min)	(mm/rev)	(m/min)	(mm/rev)	(°)	(°)

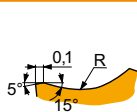

TN geometria per operazioni di troncatura e scanalatura, da taglio continuo a leggermente interrotto.

LFUX 030802TN	6640	0.2	150	0.10	–	–	140	0.10	–	–	–	–	–	–	–
	T8330	0.2	130	0.10	–	–	120	0.10	–	–	–	–	–	–	–
LFUX 040802TN	6640	0.2	150	0.12	–	–	140	0.12	–	–	–	–	–	–	–
	T8330	0.2	130	0.12	–	–	120	0.12	–	–	–	–	–	–	–
LFUX 050802TN	6640	0.2	150	0.15	–	–	140	0.15	–	–	–	–	–	–	–
	T8330	0.2	130	0.15	–	–	120	0.15	–	–	–	–	–	–	–
LFUX 060802TN	6640	0.2	150	0.20	–	–	140	0.20	–	–	–	–	–	–	–
	T8330	0.2	130	0.20	–	–	120	0.20	–	–	–	–	–	–	–

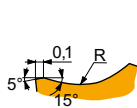

TR geometria destra per operazioni di troncatura, da taglio continuo a leggermente interrotto.

LFUX 030800TR	6640	0.2	150	0.10	–	–	140	0.10	–	–	–	–	5	–
	T8330	0.2	130	0.10	–	–	120	0.10	–	–	–	–	5	–
LFUX 040800TR	6640	0.2	150	0.12	–	–	140	0.12	–	–	–	–	5	–
	T8330	0.2	130	0.12	–	–	120	0.12	–	–	–	–	5	–

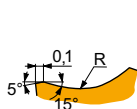

TL geometria sinistra, per operazioni di troncatura, da taglio continuo a leggermente interrotto.

LFUX 030800TL	6640	0.2	150	0.10	–	–	140	0.10	–	–	–	–	–	5
	T8330	0.2	130	0.10	–	–	120	0.10	–	–	–	–	–	5

XLCF(RL)



PRAMET

X

Utensile esterno per troncatura, per inserti LFUX

Utensile esterno destro / sinistro per scanalare con inserti LFUX 0308, 0408, 0508 o 0608 mono taglienti. Adatto per troncatura fino ad un massimo di Ø65 mm. Disponibile con dimensioni stelo da 16x12 fino a 32x25 mm. Corpo trattato per una maggiore durata dell'utensile.

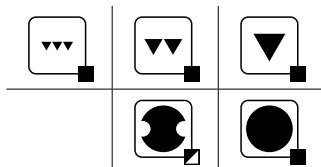
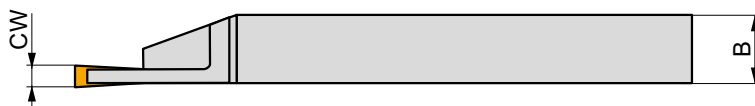
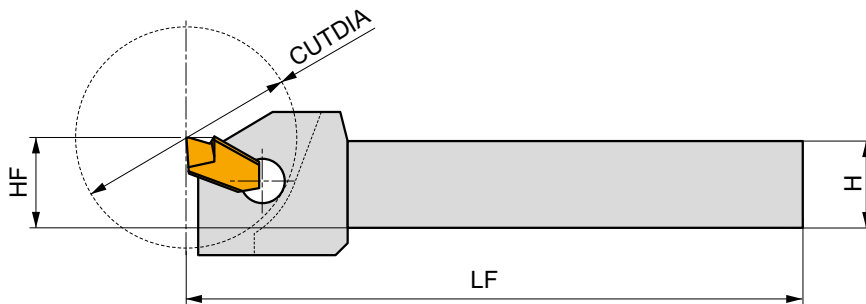
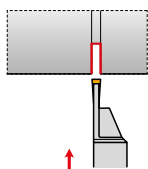

Codice prodotto	HF	H	B	LF	CW	CUTDIA	kg			
	(mm)	(mm)	(mm)	(mm)	(mm)	(mm)				
R	XLCFR 1612 H 03	16	16	12	100	3.00	40	0.14	GI018	KV
	XLCFR 2016 K 03	20	20	16	130	3.00	50	0.30	GI018	KV
	XLCFR 2520 K 03	25	25	20	130	3.00	50	0.44	GI018	KV
	XLCFR 2016 K 04	20	20	16	130	4.00	50	0.30	GI019	KV
	XLCFR 2520 K 04	25	25	20	130	4.00	50	0.43	GI019	KV
	XLCFR 2520 K 05	25	25	20	130	5.00	50	0.45	GI020	KV
	XLCFR 3225 P 05	32	32	25	170	5.00	65	0.90	GI020	KV
	XLCFR 3225 P 06	32	32	25	170	6.00	65	0.91	GI021	KV
L	XLCFL 1612 H 03	16	16	12	100	3.00	40	0.15	GI018	KV
	XLCFL 2016 K 03	20	20	16	130	3.00	50	0.30	GI018	KV
	XLCFL 2520 K 03	25	25	20	130	3.00	50	0.47	GI018	KV
	XLCFL 2016 K 04	20	20	16	130	4.00	50	0.30	GI019	KV
	XLCFL 2520 K 04	25	25	20	130	4.00	50	0.46	GI019	KV
	XLCFL 2520 K 05	25	25	20	130	5.00	50	0.50	GI020	KV
	XLCFL 3225 P 05	32	32	25	170	5.00	65	0.95	GI020	KV
	XLCFL 3225 P 06	32	32	25	170	6.00	65	0.70	GI021	KV



GI018
GI019
GI020
GI021

LFUX 0308..
LFUX 0408..
LFUX 0508..
LFUX 0608..



KV

KV 5x70

XLCFN B LFUX

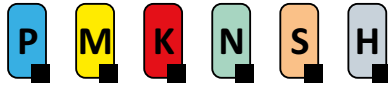

PRAMET



Lama da troncatura a doppio lato per inserti LFUX

Lama per applicazioni di troncatura fino a una profondità massima di 100 mm o barra Ø200 mm. Adatta per inserti LFUX mono-taglienti. Disponibile nelle altezze 26, 32 o 47 mm. Può essere alloggiata nei supporti DU, D Pramet. Lama trattata per una maggiore durata dell'utensile.

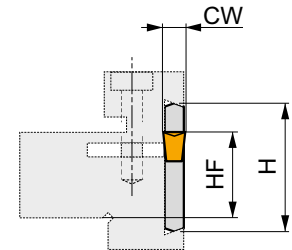
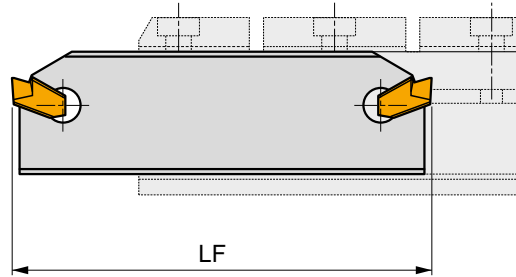
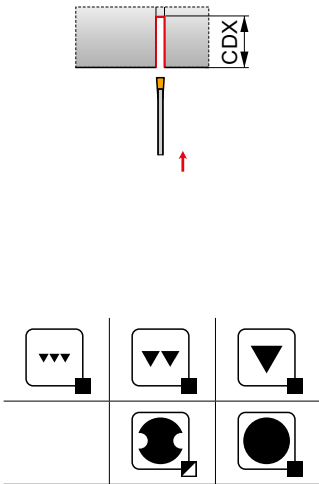

Codice prodotto	Ξ (mm)	H (mm)	LF (mm)	CW (mm)	CDX (mm)	kg	GI	KV
XLCFN 2603 J 03	21.4	26	110	3.10	37.5	0.06	GI018	KV
XLCFN 3202 M 03	25	32	150	3.10	50	0.09	GI018	KV
XLCFN 3203 M 04	25	32	150	4.10	50	0.11	GI019	KV
XLCFN 3204 M 05	25	32	150	5.10	60	0.14	GI020	KV
XLCFN 4704 S 05	38	47	270	5.10	100	0.47	GI020	KV
XLCFN 4705 S 06	38	47	270	6.10	100	0.50	GI021	KV

GI	LFUX
GI018	LFUX 0308..
GI019	LFUX 0408..
GI020	LFUX 0508..
GI021	LFUX 0608..

KV	Supporto
KV	KV 5x70



Blocco porta lama per lame di troncatura

Portautensile per adattare lame di troncatura GL o XLC. Disponibile nelle dimensioni 20x20 fino a 40x40 mm. Corpi trattati per una maggiore durata.

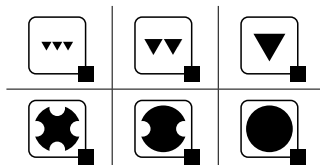
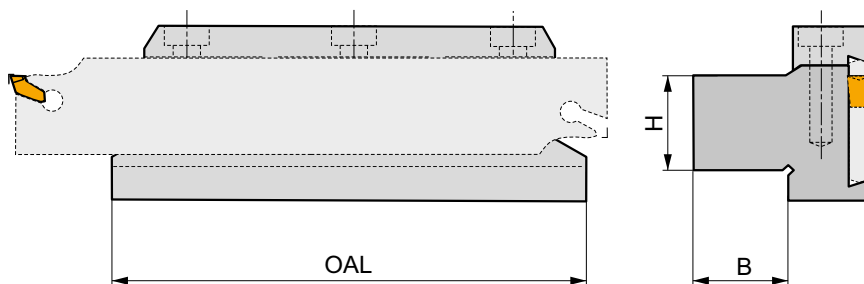
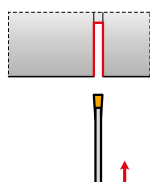

Codice prodotto	H (mm)	B (mm)	OAL (mm)	kg		
26-DU 2020	20	20	90	0.70	GI007	ND2
26-D 2020	20	20	100	0.82	GI007	ND2
32-DU 2523	25	23	110	1.02	GI008	ND2
32-DU 2532	25	32	110	1.10	GI008	ND2
32-DU 3229	32	29	110	1.25	GI008	ND2
32-D 2530	25	30	115	1.30	GI008	ND2
45-DU 3229	32	29	110	1.50	GI009	ND7
45-DU 4036	40	36	110	2.05	GI009	ND7
47-D 4040	40	40	150	3.88	GI091	ND3

GI007	XLC.N 26..	GL.-S26.B
GI008	XLC.N 32..	GL.-S32.B
GI009	XLC.N 45..	-
GI091	XLC.N 47..	-

ND2	HS 0625	6.0	M 6	25	HXK 5
ND3	HS 1030	8.0	M 10	30	HXK 8
ND7	HS 0630	6.0	M 6	30	HXK 5

NEW

X 61

PRAMET

	W1	CWTOLL	CWTOLU	S
	(mm)	(mm)	(mm)	(mm)
0602	6.350	-0.03	0.03	2.33

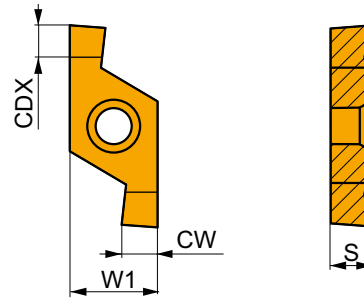

Idoneità e valori iniziali per velocità di taglio (Vc) e avanzamento (f). Fare riferimento alla nostra App Machining Calculator per ulteriori calcoli.

Codice prodotto	RE	P		M		K		N		S		H		CW	CDX
		vc	f	vc	f	vc	f	vc	f	vc	f	vc	f		
	(mm)	(m/min)	(mm/rev)	(m/min)	(mm/rev)	(m/min)	(mm/rev)	(m/min)	(mm/rev)	(m/min)	(mm/rev)	(m/min)	(mm/rev)	(mm)	(mm)

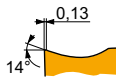

X 61-R esterno e interno, geometria versione destra, per scanalatura sedi O-ring e anelli Seeger, taglio continuo.

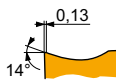

X61 0602-080 R	6640	-	195	0.06	115	0.05	185	0.06	-	-	-	-	-	0.85	0.8
	G8330	-	145	0.06	85	0.05	135	0.06	-	-	-	-	-	0.85	0.8
X61 0602-090 R	6640	-	195	0.06	115	0.05	185	0.06	-	-	-	-	-	0.95	0.8
	G8330	-	145	0.06	85	0.05	135	0.06	-	-	-	-	-	0.95	0.8
X61 0602-100 R	6640	-	195	0.06	115	0.05	185	0.06	-	-	-	-	-	1.05	0.8
	G8330	-	145	0.06	85	0.05	135	0.06	-	-	-	-	-	1.05	0.8
X61 0602-110 R	6640	-	185	0.06	110	0.05	175	0.06	-	-	-	-	-	1.15	1.2
	G8330	-	140	0.06	80	0.05	130	0.06	-	-	-	-	-	1.15	1.2
X61 0602-130 R	6640	-	185	0.06	110	0.05	175	0.06	-	-	-	-	-	1.35	1.4
	G8330	-	140	0.06	80	0.05	130	0.06	-	-	-	-	-	1.35	1.4
X61 0602-150 R	6640	-	180	0.06	105	0.05	170	0.06	-	-	-	-	-	1.55	1.6
	G8330	-	135	0.06	80	0.05	125	0.06	-	-	-	-	-	1.55	1.6
X61 0602-160 R	6640	-	180	0.06	105	0.05	170	0.06	-	-	-	-	-	1.65	1.7
	G8330	-	135	0.06	80	0.05	125	0.06	-	-	-	-	-	1.65	1.7
X61 0602-185 R	6640	-	150	0.09	90	0.08	140	0.09	-	-	-	-	-	1.90	2
	G8330	-	120	0.09	70	0.08	110	0.09	-	-	-	-	-	1.90	2
X61 0602-200 R	G8330	-	115	0.09	65	0.08	105	0.09	-	-	-	-	-	2.05	2.2
X61 0602-215 R	6640	-	145	0.09	85	0.08	135	0.09	-	-	-	-	-	2.20	2.4
	G8330	-	115	0.09	65	0.08	105	0.09	-	-	-	-	-	2.20	2.4
X61 0602-250 R	G8330	-	115	0.09	65	0.08	105	0.09	-	-	-	-	-	2.55	2.6
X61 0602-265 R	6640	-	125	0.12	75	0.11	115	0.12	-	-	-	-	-	2.70	2.7
	G8330	-	105	0.12	60	0.11	95	0.12	-	-	-	-	-	2.70	2.7
X61 0602-300 R	6640	-	125	0.12	75	0.11	115	0.12	-	-	-	-	-	3.05	3
	G8330	-	105	0.12	60	0.11	95	0.12	-	-	-	-	-	3.05	3
X61 0602-315 R	6640	-	125	0.12	75	0.11	115	0.12	-	-	-	-	-	3.20	3
	G8330	-	105	0.12	60	0.11	95	0.12	-	-	-	-	-	3.20	3



X 61-L esterno e interno, geometria versione sinistra, per scanalatura sedi O-ring e anelli Seeger, taglio continuo.

X61 0602-080 L	6640	-	195	0.06	115	0.05	185	0.06	-	-	-	-	-	0.85	0.8
	G8330	-	145	0.06	85	0.05	135	0.06	-	-	-	-	-	0.85	0.8
X61 0602-090 L	6640	-	195	0.06	115	0.05	185	0.06	-	-	-	-	-	0.95	0.8
	G8330	-	145	0.06	85	0.05	135	0.06	-	-	-	-	-	0.95	0.8
X61 0602-100 L	6640	-	195	0.06	115	0.05	185	0.06	-	-	-	-	-	1.05	0.8
	G8330	-	145	0.06	85	0.05	135	0.06	-	-	-	-	-	1.05	0.8
X61 0602-110 L	6640	-	185	0.06	110	0.05	175	0.06	-	-	-	-	-	1.15	1.2
	G8330	-	140	0.06	80	0.05	130	0.06	-	-	-	-	-	1.15	1.2
X61 0602-130 L	6640	-	185	0.06	110	0.05	175	0.06	-	-	-	-	-	1.35	1.4
	G8330	-	140	0.06	80	0.05	130	0.06	-	-	-	-	-	1.35	1.4

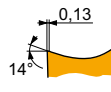
Idoneità e valori iniziali per velocità di taglio (Vc) e avanzamento (f). Fare riferimento alla nostra App Machining Calculator per ulteriori calcoli.

Codice prodotto	RE (mm)	P		M		K		N		S		H		CW (mm)	CDX (mm)
		vc (m/min)	f (mm/rev)	vc (m/min)	f (mm/rev)	vc (m/min)	f (mm/rev)	vc (m/min)	f (mm/rev)	vc (m/min)	f (mm/rev)	vc (m/min)	f (mm/rev)		
															
		X 61-L esterno e interno, geometria versione sinistra, per scanalatura sedi O-ring e anelli Seeger, taglio continuo.													
X61 0602-150 L	6640	-	180	0.06	105	0.05	170	0.06	-	-	-	-	-	1.55	1.6
	G8330	-	135	0.06	80	0.05	125	0.06	-	-	-	-	-	1.55	1.6
X61 0602-160 L	6640	-	180	0.06	105	0.05	170	0.06	-	-	-	-	-	1.65	1.7
	G8330	-	135	0.06	80	0.05	125	0.06	-	-	-	-	-	1.65	1.7
X61 0602-185 L	6640	-	150	0.09	90	0.08	140	0.09	-	-	-	-	-	1.90	2
	G8330	-	120	0.09	70	0.08	110	0.09	-	-	-	-	-	1.90	2
X61 0602-200 L	G8330	-	115	0.09	65	0.08	105	0.09	-	-	-	-	-	2.05	2.2
X61 0602-215 L	6640	-	145	0.09	85	0.08	135	0.09	-	-	-	-	-	2.20	2.4
	G8330	-	115	0.09	65	0.08	105	0.09	-	-	-	-	-	2.20	2.4
X61 0602-250 L	G8330	-	115	0.09	65	0.08	105	0.09	-	-	-	-	-	2.55	2.6
X61 0602-265 L	6640	-	125	0.12	75	0.11	115	0.12	-	-	-	-	-	2.70	2.7
	G8330	-	105	0.12	60	0.11	95	0.12	-	-	-	-	-	2.70	2.7
X61 0602-300 L	6640	-	125	0.12	75	0.11	115	0.12	-	-	-	-	-	3.05	3
	G8330	-	105	0.12	60	0.11	95	0.12	-	-	-	-	-	3.05	3
X61 0602-315 L	6640	-	125	0.12	75	0.11	115	0.12	-	-	-	-	-	3.20	3
	G8330	-	105	0.12	60	0.11	95	0.12	-	-	-	-	-	3.20	3

NEW





X 61 R

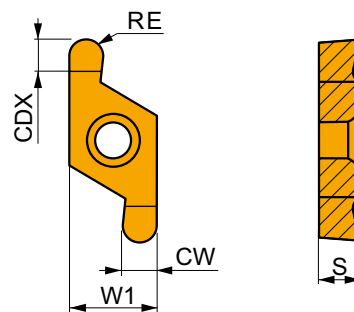

	W1 (mm)	CWTOLL (mm)	CWTOLU (mm)	S (mm)
0602	6.350	-0.03	0.03	2.33

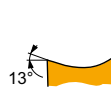

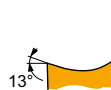
Idoneità e valori iniziali per velocità di taglio (Vc) e avanzamento (f). Fare riferimento alla nostra App Machining Calculator per ulteriori calcoli.

Codice prodotto	RE (mm)	P		M		K		N		S		H		CW (mm)	CDX (mm)
		vc (m/min)	f (mm/rev)	vc (m/min)	f (mm/rev)	vc (m/min)	f (mm/rev)	vc (m/min)	f (mm/rev)	vc (m/min)	f (mm/rev)	vc (m/min)	f (mm/rev)		
															
		X 61 R-R esterno e interno, geometria versione destra, per scanalatura sedi O-ring e anelli Seeger, taglio continuo.													
X61 0602-R100 R	6640	1.0	170	0.06	100	0.05	160	0.06	-	-	-	-	-	2.09	3
	G8330	1.0	130	0.06	75	0.05	120	0.06	-	-	-	-	-	2.09	3
X61 0602-R150 R	6640	1.5	170	0.06	100	0.05	160	0.06	-	-	-	-	-	3.09	3
	G8330	1.5	130	0.06	75	0.05	120	0.06	-	-	-	-	-	3.09	3
															
		X 61 R-L esterno e interno, geometria versione sinistra, per scanalatura sedi O-ring e anelli Seeger, taglio continuo.													
X61 0602-R100 L	6640	1.0	170	0.06	100	0.05	160	0.06	-	-	-	-	-	2.09	3
	G8330	1.0	130	0.06	75	0.05	120	0.06	-	-	-	-	-	2.09	3
X61 0602-R150 L	6640	1.5	170	0.06	100	0.05	160	0.06	-	-	-	-	-	3.09	3
	G8330	1.5	130	0.06	75	0.05	120	0.06	-	-	-	-	-	3.09	3

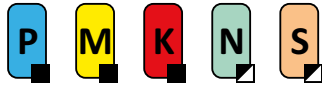
NEW**P61(RL) EXT**

PRAMET

S

**Utensile esterno per scanalatura con inserti X61 per Seeger e O-Ring**

Utensile esterno destro / sinistro per scanalatura con inserti bi-taglienti X61 per anelli Seeger e O-ring. Fornisce un'azione di taglio regolare e dimensioni con tolleranze strette. Disponibile con dimensioni stelo da 16x16 fino a 25x25 mm. Corpo trattato per una maggiore durata dell'utensile.

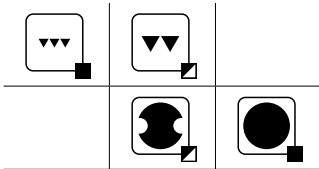
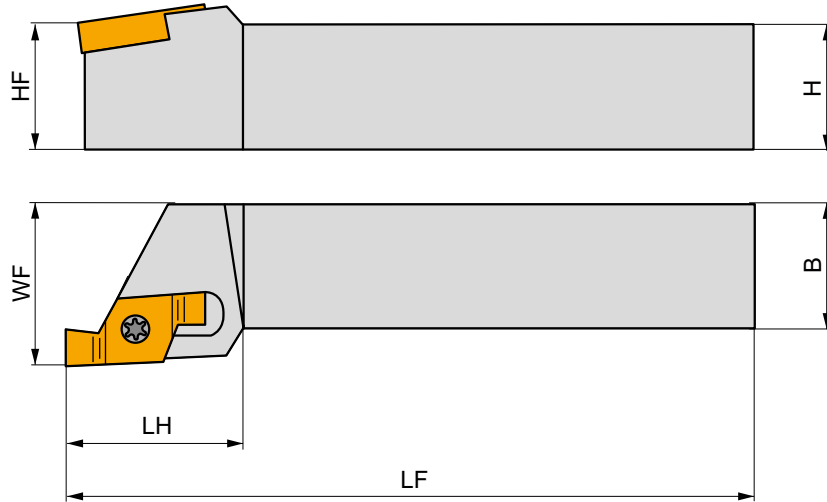
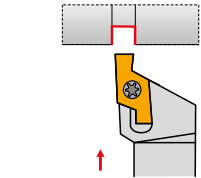

Codice prodotto	HF (mm)	H (mm)	B (mm)	WF (mm)	LF (mm)	H (mm)	kg		
R P61.SFR-1616H-06	16	16	16	20	100	21	0.23	G332	SV11
P61.SFR-2020K-06	20	20	20	25	125	25	0.40	G332	SV11
P61.SFR-2525M-06	25	25	25	32	150	32	0.73	G332	SV11
L P61.SFL-1616H-06	16	16	16	20	100	21	0.23	G332	SV11
P61.SFL-2020K-06	20	20	20	25	125	25	0.42	G332	SV11
P61.SFL-2525M-06	25	25	25	32	150	32	0.73	G332	SV11



G332



X61 0602..



SV11



US 2003-T07P



0.8



M 2.5



6.5



FLAGT07P

NEW**P61(RL) INT**

PRAMET

S**Utensile interno per Seeger con inserto X61**

Bareno destro/sinistro per scanalatura interna per inserti bi-taglienti X61. Diametro minimo di scanalatura interna Ø16 mm. Adatto per scanalature interne di anelli Seeger o O-ring. Disponibile con dimensioni dello stelo da Ø12 a Ø32 mm. Corpo trattato per una maggiore durata.

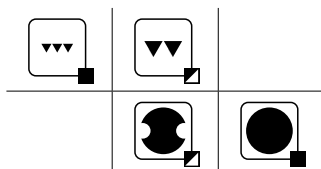
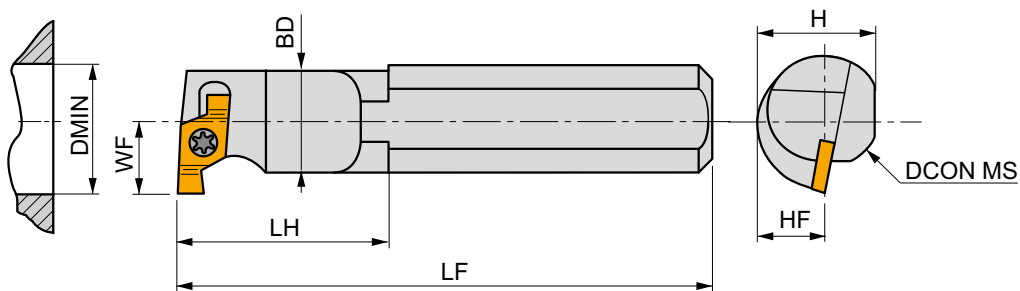
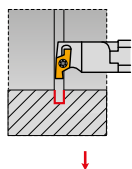

Codice prodotto	DCON MS	DMIN	BD	WF	H	LF	LH	KAPR					
	(mm)	(mm)	(mm)	(mm)	(mm)	(mm)	(mm)	(°)					
R	P61.SGR-0012M-06	12	16	11.5	9	11	150	22	0	-	0.17	G1332	SV11
	P61.SGR-A-0016M-06	16	20	15	11	15	150	29	0	✓	0.21	G1332	SV11
	P61.SGR-A-0020P-06	20	25	19	13	18	170	29	0	✓	0.38	G1332	SV11
	P61.SGR-A-0025R-06	25	32	24	17	23	200	31	0	✓	0.70	G1332	SV11
	P61.SGR-A-0032T-06	32	40	31	22	30	300	49	0	✓	1.72	G1332	SV11
L	P61.SGL-0012M-06	12	16	11.5	9	11	150	22	0	-	0.17	G1332	SV11
	P61.SGL-A-0016M-06	16	20	15	11	15	150	29	0	✓	0.24	G1332	SV11
	P61.SGL-A-0020P-06	20	25	19	13	18	170	29	0	✓	0.40	G1332	SV11
	P61.SGL-A-0025R-06	25	32	24	17	23	200	31	0	✓	0.72	G1332	SV11
	P61.SGL-A-0032T-06	32	40	31	22	30	300	49	0	✓	1.72	G1332	SV11



G1332



X61 0602..



SV11



US 2003-T07P



0.8



M 2.5



6.5



FLAG T07P

Montaggio dell'inserto sinistro sulla barra di alesatura destra.

NEW

X 61-1

PRAMET

	W1	CWTOLL	CWTOLU	S
	(mm)	(mm)	(mm)	(mm)
0602	6.350	-0.03	0.03	2.33

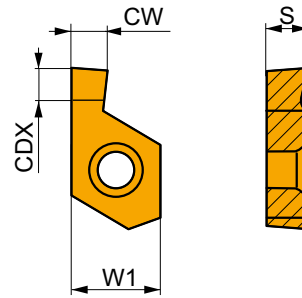

Idoneità e valori iniziali per velocità di taglio (Vc) e avanzamento (f). Fare riferimento alla nostra App Machining Calculator per ulteriori calcoli.

Codice prodotto	RE (mm)	P		M		K		N		S		H		CW (mm)	CDX (mm)
		vc (m/min)	f (mm/rev)	vc (m/min)	f (mm/rev)	vc (m/min)	f (mm/rev)	vc (m/min)	f (mm/rev)	vc (m/min)	f (mm/rev)	vc (m/min)	f (mm/rev)		

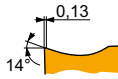

X 61-1-R interno, geometria versione destra, mono tagliente per scanalatura sedi O-ring e anelli Seeger, taglio continuo.

X61 0602-080 R1	6640	-	195	0.06	115	0.05	185	0.06	-	-	-	-	0.85	0.8
X61 0602-090 R1	6640	-	195	0.06	115	0.05	185	0.06	-	-	-	-	0.95	0.8
X61 0602-110 R1	6640	-	185	0.06	110	0.05	175	0.06	-	-	-	-	1.15	1.2
X61 0602-130 R1	6640	-	185	0.06	110	0.05	175	0.06	-	-	-	-	1.35	1.4
X61 0602-160 R1	6640	-	180	0.06	105	0.05	170	0.06	-	-	-	-	1.65	1.7
X61 0602-185 R1	6640	-	150	0.09	90	0.08	140	0.09	-	-	-	-	1.90	2
X61 0602-215 R1	6640	-	145	0.09	85	0.08	135	0.09	-	-	-	-	2.20	2.2

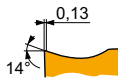

X 61-1-L interno, geometria versione sinistra, mono tagliente per scanalatura sedi O-ring e anelli Seeger, taglio continuo.

X61 0602-080 L1	6640	-	195	0.06	115	0.05	185	0.06	-	-	-	-	0.85	0.8
X61 0602-090 L1	6640	-	195	0.06	115	0.05	185	0.06	-	-	-	-	0.95	0.8
X61 0602-110 L1	6640	-	185	0.06	110	0.05	175	0.06	-	-	-	-	1.15	1.2
X61 0602-130 L1	6640	-	185	0.06	110	0.05	175	0.06	-	-	-	-	1.35	1.4
X61 0602-160 L1	6640	-	180	0.06	105	0.05	170	0.06	-	-	-	-	1.65	1.7
X61 0602-185 L1	6640	-	150	0.09	90	0.08	140	0.09	-	-	-	-	1.90	2
X61 0602-215 L1	6640	-	145	0.09	85	0.08	135	0.09	-	-	-	-	2.20	2.2

NEW

X 61 R-1

PRAMET

	W1 (mm)	CWTOLL (mm)	CWTOLU (mm)	S (mm)
0602	6.350	-0.03	0.03	2.33

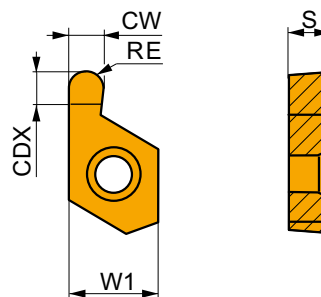

Idoneità e valori iniziali per velocità di taglio (Vc) e avanzamento (f). Fare riferimento alla nostra App Machining Calculator per ulteriori calcoli.

Codice prodotto	RE (mm)	P		M		K		N		S		H		CW (mm)	CDX (mm)
		vc (m/min)	f (mm/rev)	vc (m/min)	f (mm/rev)	vc (m/min)	f (mm/rev)	vc (m/min)	f (mm/rev)	vc (m/min)	f (mm/rev)	vc (m/min)	f (mm/rev)		



X 61 R-1-R interno, geometria versione destra, mono tagliente per scanalatura sedi O-ring e anelli Seeger, taglio continuo.

X61 0602-R050 R1	6640	0.5	■ 185	■ 0.06	■ 110	■ 0.05	■ 175	■ 0.06	■ -	■ -	■ -	■ -	■ -	1.09	1.3
X61 0602-R100 R1	6640	1.0	■ 170	■ 0.06	■ 100	■ 0.05	■ 160	■ 0.06	■ -	■ -	■ -	■ -	■ -	2.09	2.8



X 61 R-1-L interno, geometria versione sinistra, mono tagliente per scanalatura sedi O-ring e anelli Seeger, taglio continuo.

X61 0602-R050 L1	6640	0.5	■ 185	■ 0.06	■ 110	■ 0.05	■ 175	■ 0.06	■ -	■ -	■ -	■ -	■ -	1.09	1.3
X61 0602-R100 L1	6640	1.0	■ 170	■ 0.06	■ 100	■ 0.05	■ 160	■ 0.06	■ -	■ -	■ -	■ -	■ -	2.09	2.8

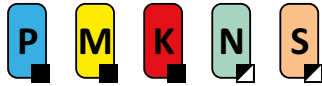
NEW**P61S(RL)-1 INT**

PRAMET

S**Utensile interno per Seeger con inserto X61-1**

Bareno destro/sinistro per scanalatura interna per inserti mono-tagliente X61-1. Diametro minimo di scanalatura interna Ø12.5 mm. Adatto per scanalature interne di anelli Seeger o O-ring. Disponibile con dimensioni dello stelo da Ø10 e Ø12 mm. Corpo trattato per una maggiore durata.

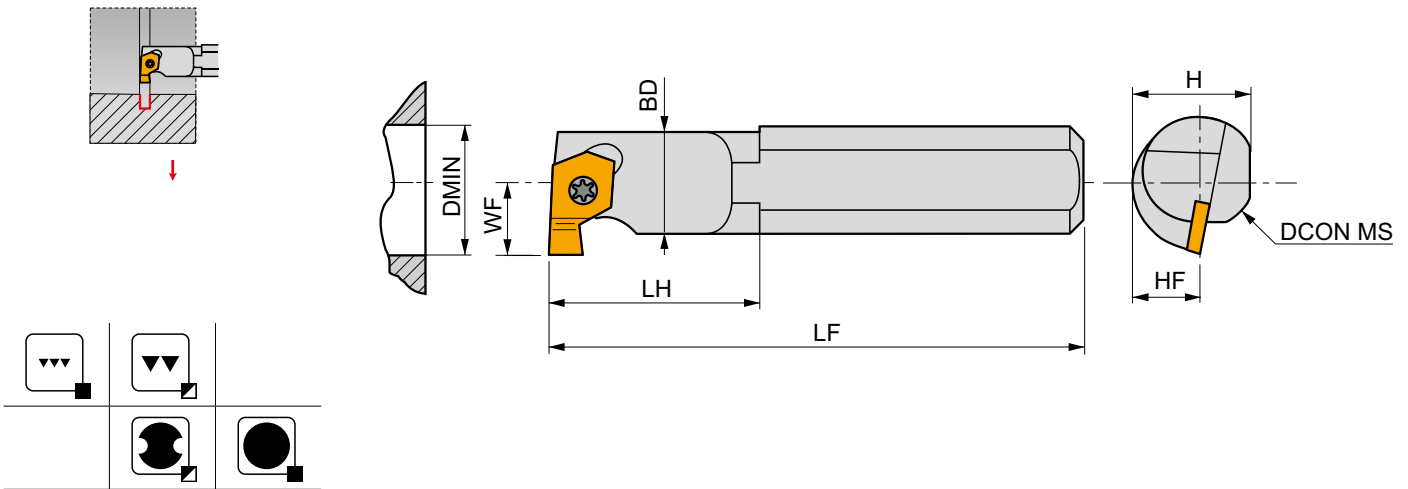

Codice prodotto	DCON MS	DMIN	BD	WF	H	LF	LH	KAPR	kg	G333	SV11
	(mm)	(mm)	(mm)	(mm)	(mm)	(mm)	(mm)	(°)			
R P61.SGR-0010M-06/1	10	12.5	10	7.5	9	150	19	0	0.24	G333	SV11
P61.SGR-0012M-06/1	12	12.5	10	7.5	11	150	19	0	0.17	G333	SV11
L P61.SGL-0010M-06/1	10	12.5	10	7.5	9	150	19	0	0.13	G333	SV11
P61.SGL-0012M-06/1	12	12.5	10	7.5	11	150	19	0	0.17	G333	SV11

G333	X61 0602..-1
------	--------------

SV11	US 2003-T07P	0.8	M 2.5	6.5	FLAG T07P
------	--------------	-----	-------	-----	-----------

Montaggio dell'inserto sinistro sulla barra di alesatura destra.

TN R EXT

	IC	D1	S	CWTOLL	CWTOLU
	(mm)	(mm)	(mm)	(mm)	(mm)
16	9.525	3.90	3.58	0.00	0.05
22	12.700	4.90	4.70	0.00	0.05

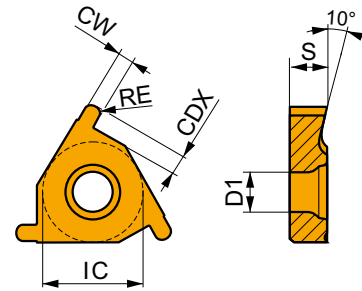

Idoneità e valori iniziali per velocità di taglio (Vc) e avanzamento (f). Fare riferimento alla nostra App Machining Calculator per ulteriori calcoli.

Codice prodotto	RE (mm)	P		M		K		N		S		H		CW (mm)	CDX (mm)
		vc (m/min)	f (mm/rev)	vc (m/min)	f (mm/rev)	vc (m/min)	f (mm/rev)	vc (m/min)	f (mm/rev)	vc (m/min)	f (mm/rev)	vc (m/min)	f (mm/rev)		

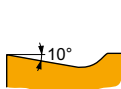

TN ER-R esterno destro, per operazioni di scanalatura sedi O-ring e anelli Seeger, taglio continuo.

TN 16ER-R050	T8330	0.5	130	0.06	75	0.05	120	0.06	–	–	–	–	–	–	1.00	1.3
TN 16ER-R100	T8330	1.0	130	0.06	75	0.05	120	0.06	–	–	–	–	–	–	2.00	1.85
TN 22ER-R150	T8330	1.5	130	0.06	75	0.05	120	0.06	–	–	–	–	–	–	3.00	2.2

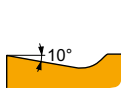

TN EL-R esterno sinistro, per operazioni di scanalatura sedi O-ring e anelli Seeger, taglio continuo.

TN 16EL-R050	T8330	0.5	130	0.06	75	0.05	120	0.06	–	–	–	–	–	–	1.00	1.3
TN 16EL-R100	T8330	1.0	130	0.06	75	0.05	120	0.06	–	–	–	–	–	–	2.00	1.85
TN 22EL-R150	T8330	1.5	130	0.06	75	0.05	120	0.06	–	–	–	–	–	–	3.00	2.2

TN R INT

	IC	D1	S	CWTOLL	CWTOLU
	(mm)	(mm)	(mm)	(mm)	(mm)
11	6.350	2.80	3.10	0.00	0.05
16	9.525	3.90	3.58	0.00	0.05
22	12.700	4.90	4.70	0.00	0.05

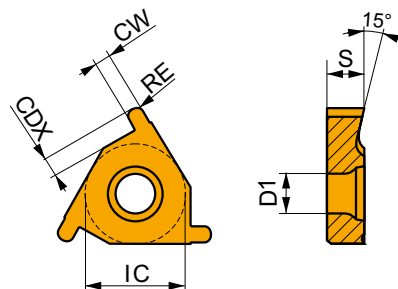

Idoneità e valori iniziali per velocità di taglio (Vc) e avanzamento (f). Fare riferimento alla nostra App Machining Calculator per ulteriori calcoli.

Codice prodotto	RE (mm)	P		M		K		N		S		H		CW (mm)	CDX (mm)
		vc (m/min)	f (mm/rev)	vc (m/min)	f (mm/rev)	vc (m/min)	f (mm/rev)	vc (m/min)	f (mm/rev)	vc (m/min)	f (mm/rev)	vc (m/min)	f (mm/rev)		

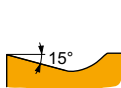

TN NR-R interno destro, per operazioni di scanalatura sedi O-ring e anelli Seeger, taglio continuo.

TN 11NR-R050	T8330	0.5	130	0.06	75	0.05	120	0.06	–	–	–	–	–	–	1.00	1.3
TN 16NR-R100	T8330	1.0	130	0.06	75	0.05	120	0.06	–	–	–	–	–	–	2.00	1.85
TN 22NR-R150	T8330	1.5	130	0.06	75	0.05	120	0.06	–	–	–	–	–	–	3.00	2.2

Idoneità e valori iniziali per velocità di taglio (Vc) e avanzamento (f). Fare riferimento alla nostra App Machining Calculator per ulteriori calcoli.

Codice prodotto	RE (mm)	P		M		K		N		S		H		CW (mm)	CDX (mm)
		vc (m/min)	f (mm/rev)	vc (m/min)	f (mm/rev)	vc (m/min)	f (mm/rev)	vc (m/min)	f (mm/rev)	vc (m/min)	f (mm/rev)	vc (m/min)	f (mm/rev)		

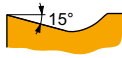

TN NL-R interno sinistro, per operazioni di scanalatura sedi O-ring e anelli Seeger, taglio continuo.

TN 11NL-R050	T8330	0.5	130	0.06	75	0.05	120	0.06	-	-	-	-	-	1.00	1.3
TN 16NL-R100	T8330	1.0	130	0.06	75	0.05	120	0.06	-	-	-	-	-	2.00	1.85
TN 22NL-R150	T8330	1.5	130	0.06	75	0.05	120	0.06	-	-	-	-	-	3.00	2.2

TN ZZ EXT

PRAMET

	IC (mm)	D1 (mm)	S (mm)
16	9.525	3.90	3.40
22	12.700	4.90	4.70

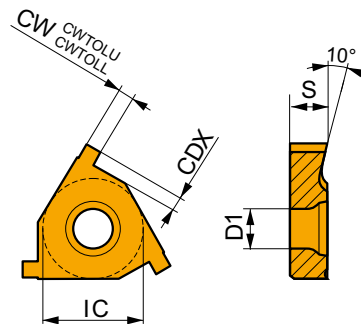

Idoneità e valori iniziali per velocità di taglio (Vc) e avanzamento (f). Fare riferimento alla nostra App Machining Calculator per ulteriori calcoli.

Codice prodotto	RE (mm)	P		M		K		N		S		H		CW (mm)	CWTOLL (mm)	CWTOLU (mm)	CDX (mm)
		vc (m/min)	f (mm/rev)	vc (m/min)	f (mm/rev)	vc (m/min)	f (mm/rev)	vc (m/min)	f (mm/rev)	vc (m/min)	f (mm/rev)	vc (m/min)	f (mm/rev)				

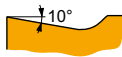

TN ER-ZZ esterno destro, per operazioni di scanalatura sedi O-ring e anelli Seeger, taglio continuo.

TN 16ER090ZZ	T8330	-	130	0.09	75	0.08	120	0.09	-	-	-	-	-	0.90	0.05	0.10	0.9
TN 16ER110ZZ	T8330	-	130	0.09	75	0.08	120	0.09	-	-	-	-	-	1.10	0.05	0.10	1.3
TN 16ER130ZZ	T8330	-	130	0.09	75	0.08	120	0.09	-	-	-	-	-	1.30	0.05	0.10	1.6
TN 16ER160ZZ	T8330	-	130	0.09	75	0.08	120	0.09	-	-	-	-	-	1.60	0.05	0.10	1.85
TN 16ER185ZZ	T8330	-	130	0.09	75	0.08	120	0.09	-	-	-	-	-	1.85	0.05	0.10	1.85
TN 16ER215ZZ	T8330	-	130	0.09	75	0.08	120	0.09	-	-	-	-	-	2.15	0.05	0.10	1.85
TN 16ER265ZZ	T8330	-	130	0.12	75	0.11	120	0.12	-	-	-	-	-	2.65	0.05	0.10	2.05
TN 22ER265ZZ	T8330	-	130	0.12	75	0.11	120	0.12	-	-	-	-	-	2.65	0.08	0.13	2.2
TN 22ER315ZZ	T8330	-	130	0.12	75	0.11	120	0.12	-	-	-	-	-	3.15	0.08	0.13	2.2
TN 22ER415ZZ	T8330	-	130	0.12	75	0.11	120	0.12	-	-	-	-	-	4.15	0.08	0.13	2.4

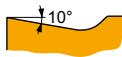

TN EL-ZZ esterno sinistro, per operazioni di scanalatura sedi O-ring e anelli Seeger, taglio continuo.

TN 16EL090ZZ	T8330	-	130	0.06	75	0.05	120	0.06	-	-	-	-	-	0.90	0.05	0.10	0.9
TN 16EL110ZZ	T8330	-	130	0.06	75	0.05	120	0.06	-	-	-	-	-	1.10	0.05	0.10	1.3
TN 16EL130ZZ	T8330	-	130	0.06	75	0.05	120	0.06	-	-	-	-	-	1.30	0.05	0.10	1.6
TN 16EL160ZZ	T8330	-	130	0.06	75	0.05	120	0.06	-	-	-	-	-	1.60	0.05	0.10	1.85
TN 16EL185ZZ	T8330	-	130	0.06	75	0.05	120	0.06	-	-	-	-	-	1.85	0.05	0.10	1.85
TN 16EL215ZZ	T8330	-	130	0.09	75	0.08	120	0.09	-	-	-	-	-	2.15	0.05	0.10	1.85
TN 16EL265ZZ	T8330	-	130	0.09	75	0.08	120	0.09	-	-	-	-	-	2.65	0.05	0.10	2.05
TN 22EL265ZZ	T8330	-	130	0.12	75	0.11	120	0.12	-	-	-	-	-	2.65	0.08	0.13	2.2
TN 22EL315ZZ	T8330	-	130	0.12	75	0.11	120	0.12	-	-	-	-	-	3.15	0.08	0.13	2.2
TN 22EL415ZZ	T8330	-	130	0.12	75	0.11	120	0.12	-	-	-	-	-	4.15	0.08	0.13	2.4

TN ZZ INT

	IC	D1	S
	(mm)	(mm)	(mm)
11	6.350	2.80	3.00
16	9.525	3.90	3.40
22	12.700	4.90	4.70

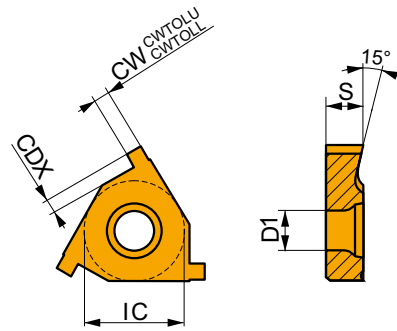

Idoneità e valori iniziali per velocità di taglio (Vc) e avanzamento (f). Fare riferimento alla nostra App Machining Calculator per ulteriori calcoli.

Codice prodotto	RE	P		M		K		N		S		H		CW	CWTOLL	CWTOLU	CDX
		vc	f	vc	f	vc	f	vc	f	vc	f	vc	f				
	(mm)	(m/min)	(mm/rev)	(m/min)	(mm/rev)	(m/min)	(mm/rev)	(m/min)	(mm/rev)	(m/min)	(mm/rev)	(m/min)	(mm/rev)	(mm)	(mm)	(mm)	(mm)

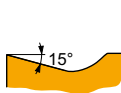

TN NR-ZZ interno destro, per operazioni di scanalatura sedi O-ring e anelli Seeger, taglio continuo.

TN 11NR090ZZ	T8330	-	█	130	0.06	█	75	0.05	█	120	0.06	-	-	-	-	0.90	0.05	0.10	0.9
TN 11NR110ZZ	T8330	-	█	130	0.06	█	75	0.05	█	120	0.06	-	-	-	-	1.10	0.05	0.10	1.3
TN 16NR090ZZ	T8330	-	█	130	0.06	█	75	0.05	█	120	0.06	-	-	-	-	0.90	0.05	0.10	0.9
TN 16NR110ZZ	T8330	-	█	130	0.06	█	75	0.05	█	120	0.06	-	-	-	-	1.10	0.05	0.10	1.3
TN 16NR130ZZ	T8330	-	█	130	0.06	█	75	0.05	█	120	0.06	-	-	-	-	1.30	0.05	0.10	1.6
TN 16NR160ZZ	T8330	-	█	130	0.06	█	75	0.05	█	120	0.06	-	-	-	-	1.60	0.05	0.10	1.85
TN 16NR185ZZ	T8330	-	█	130	0.06	█	75	0.05	█	120	0.06	-	-	-	-	1.85	0.05	0.10	1.85
TN 16NR215ZZ	T8330	-	█	130	0.09	█	75	0.08	█	120	0.09	-	-	-	-	2.15	0.05	0.10	1.85
TN 16NR265ZZ	T8330	-	█	130	0.12	█	75	0.11	█	120	0.12	-	-	-	-	2.65	0.05	0.10	2.05
TN 22NR265ZZ	T8330	-	█	130	0.12	█	75	0.11	█	120	0.12	-	-	-	-	2.65	0.08	0.13	2.2
TN 22NR315ZZ	T8330	-	█	130	0.12	█	75	0.11	█	120	0.12	-	-	-	-	3.15	0.08	0.13	2.2
TN 22NR415ZZ	T8330	-	█	130	0.12	█	75	0.11	█	120	0.12	-	-	-	-	4.15	0.08	0.13	2.4

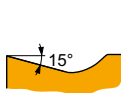

TN NL-ZZ interno sinistro, per operazioni di scanalatura sedi O-ring e anelli Seeger, taglio continuo.

TN 11NL090ZZ	T8330	-	█	130	0.06	█	75	0.05	█	120	0.06	-	-	-	-	0.90	0.05	0.10	0.9
TN 11NL110ZZ	T8330	-	█	130	0.06	█	75	0.05	█	120	0.06	-	-	-	-	1.10	0.05	0.10	1.3
TN 16NL090ZZ	T8330	-	█	130	0.06	█	75	0.05	█	120	0.06	-	-	-	-	0.90	0.05	0.10	0.9
TN 16NL110ZZ	T8330	-	█	130	0.06	█	75	0.05	█	120	0.06	-	-	-	-	1.10	0.05	0.10	1.3
TN 16NL130ZZ	T8330	-	█	130	0.06	█	75	0.05	█	120	0.06	-	-	-	-	1.30	0.05	0.10	1.6
TN 16NL160ZZ	T8330	-	█	130	0.06	█	75	0.05	█	120	0.06	-	-	-	-	1.60	0.05	0.10	1.85
TN 16NL185ZZ	T8330	-	█	130	0.06	█	75	0.05	█	120	0.06	-	-	-	-	1.85	0.05	0.10	1.85
TN 16NL215ZZ	T8330	-	█	130	0.09	█	75	0.08	█	120	0.09	-	-	-	-	2.15	0.05	0.10	1.85
TN 16NL265ZZ	T8330	-	█	130	0.09	█	75	0.08	█	120	0.09	-	-	-	-	2.65	0.05	0.10	2.05
TN 22NL265ZZ	T8330	-	█	130	0.12	█	75	0.11	█	120	0.12	-	-	-	-	2.65	0.08	0.13	2.2
TN 22NL315ZZ	T8330	-	█	130	0.12	█	75	0.11	█	120	0.12	-	-	-	-	3.15	0.08	0.13	2.2
TN 22NL415ZZ	T8330	-	█	130	0.12	█	75	0.11	█	120	0.12	-	-	-	-	4.15	0.08	0.13	2.4

SE(RL)



PRAMET

S

Utensile per filettatura esterna con bloccaggio a vite per inserti TN 16 o 22

Utensile destro/sinistro per filettature esterne con bloccaggio a vite per inserti di filettatura TN16 o TN22 ER/EL. Adatto per filettature con profilo metrico o in pollici. Adatto anche per scanalature poco profonde (anelli Seeger). Corpi trattati per una maggiore durata.

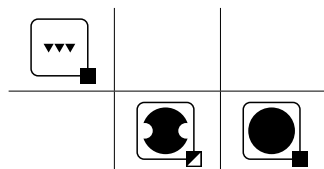
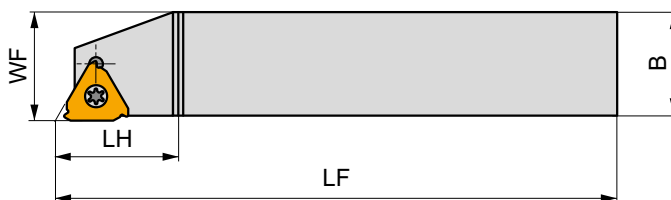
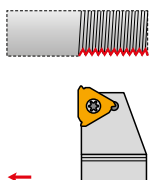

Codice prodotto	H	H _F	B	WF	LF	H	LAMS		
	(mm)	(mm)	(mm)	(mm)	(mm)	(mm)	(°)		
R SER 2020 K 16	20	20	20	20	125	22.5	–	GI068	Z12
SER 2525 M 16	25	25	25	25	150	24	–	GI068	Z12
SER 3225 P 16	32	32	25	25	170	24.5	–	GI068	Z12
SER 2525 M 22-A	25	25	25	25	150	25.5	–	GI071	Z13
SER 3225 P 22-A	32	32	25	25	170	25.5	–	GI071	Z13
L SEL 2020 K 16	20	20	20	20	125	22.5	–	GI068	Z12
SEL 2525 M 16	25	25	25	25	150	24	–	GI068	Z12
SEL 3225 P 16	32	32	25	25	170	24.5	–	GI068	Z12
SEL 2525 M 22-A	25	25	25	25	150	25.5	–	GI071	Z13
SEL 3225 P 22-A	32	32	25	25	170	25.5	–	GI071	Z13

GI068	TN 16ER..	TN 16EL..
GI071	TN 22ER..	TN 22EL..

Z12	US 3512A-T15P	3.0	M 3.5	12.7	–	HS 0304	FLAG T15P	HXK 2.5	481
Z13	US 4514A-T20	5.0	M 4.5	14	SP 0405	–	FLAG T20	–	481

SI(RL)



PRAMET

S







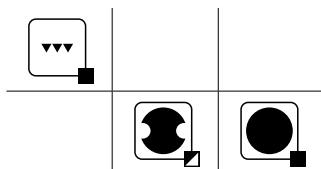
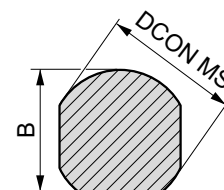
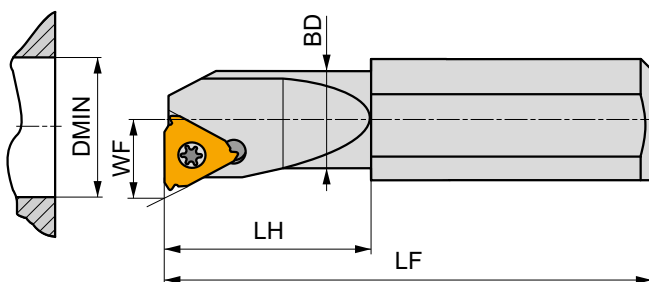
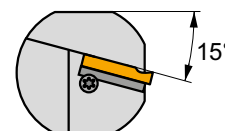
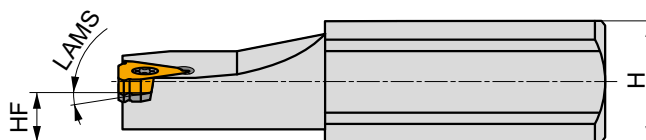
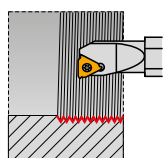









Utensile per filettatura interna con bloccaggio a vite per inserti TN 11, TN 16 e TN 22

Utensile destro/sinistro per filettature interne con bloccaggio a vite per inserti di filettatura TN 11, 16 o 22 ER/EL. Adatto per filettature con profilo metrico o in pollici. Diametro interno minimo Ø13 mm. Adatto anche per scanalature poco profonde (anelli Seeger). Disponibile con dimensioni dello stelo da Ø16 a Ø40 mm. Corpi trattati per una maggiore durata.



Codice prodotto	B	D CON MS	D MIN	BD	WF	H	HF	LF	LH	LAMS	Icona	Icona	Icona
	(mm)	(mm)	(mm)	(mm)	(mm)	(mm)	(mm)	(mm)	(mm)	(°)			
R SIR 0010 K 11-0	14.5	16	13	10	7.45	14	7	125	25	0	–	GI085	Z11
SIR 0010 K 11-1	14.5	16	13	10	7.45	14	7	125	25	1	–	GI085	Z11
SIR 0013 M 11-0	14.5	16	16	13	9	14	7	150	32	0	–	GI085	Z11
SIR 0013 M 11-1	14.5	16	16	13	9	14	7	150	32	1	–	GI085	Z11
SIR 1416 N 16-0	14	16	22	17	11.4	14.5	7.5	160	–	0	–	GI022	Z9
SIR 1416 N 16-1	14	16	22	17	11.4	14.5	7.5	160	–	1	–	GI022	Z9
SIR 1416 N 16-2	14	16	16.5	15.5	10.6	14.5	7.5	160	40	2	✓	GI022	Z10
SIR 1820 P 16	18.5	20	27	21	13.85	18	9	170	–	–	–	GI022	Z12
SIR 2325 Q 16	23.5	25	29	26	16.55	23	11.5	180	–	–	–	GI022	Z12
SIR 2532 S 16	30	32	36	32	19.75	25	12.5	250	–	–	–	GI022	Z12
SIR 2532 S 22-2	30	32	25	25	16.65	25	12.5	250	80	2	✓	GI076	Z14
SIR 2532 S 22-A	30	32	36	32	21.65	25	12.5	250	–	–	–	GI076	Z13
SIR 3240 T 22-A	38	40	48	40	25.85	32	16	300	–	–	–	GI076	Z13
L SIL 0010 K 11-0	14.5	16	13	10	7.45	14	7	125	25	0	–	GI085	Z11
SIL 0010 K 11-1	14.5	16	13	10	7.55	14	7	125	25	1	–	GI085	Z11
SIL 0013 M 11-0	14.5	16	16	13	9	14	7	150	32	0	–	GI085	Z11
SIL 0013 M 11-1	14.5	16	16	13	9	14	7	150	32	1	–	GI085	Z11
SIL 1416 N 16-0	14	16	22	17	11.4	14.5	7.5	160	–	0	–	GI022	Z9
SIL 1416 N 16-1	14	16	22	17	11.4	14.5	7.5	160	–	1	–	GI022	Z9
SIL 1416 N 16-2	14	16	16.5	15.5	10.6	14.5	7.5	160	40	2	✓	GI022	Z10
SIL 1820 P 16	18.5	20	27	21	13.85	18	9	170	–	–	–	GI022	Z12
SIL 2325 Q 16	23.5	25	29	26	16.55	23	11.5	180	–	–	–	GI022	Z12
SIL 2532 S 16	30	32	36	32	19.75	25	12.5	250	–	–	–	GI022	Z12
SIL 2532 S 22-2	30	32	25	25	16.65	25	12.5	250	80	2	✓	GI076	Z14
SIL 2532 S 22-A	30	32	36	32	21.65	25	12.5	250	–	–	–	GI076	Z13
SIL 3240 T 22-A	38	40	48	40	25.85	32	16	300	–	–	–	GI076	Z13

		
GI022	TN 16NR..	TN 16NL..
GI076	TN 22NR..	TN 22NL..
GI085	TN 11NR..	TN 11NL..

		 Nm							
Z10	US 3510A-T15P	3.0	M 3.5	10.6	-	-	FLAG T15P	-	-
Z11	US 2506-T07P	0.9	M 2.5	6.3	-	-	FLAG T07P	-	-
Z12	US 3512A-T15P	3.0	M 3.5	12.7	-	HS 0304	FLAG T15P	HXK 2.5	 481
Z13	US 4514A-T20	5.0	M 4.5	14	SP 0405	-	FLAG T20	-	 481
Z14	US 4514A-T20	5.0	M 4.5	14	-	-	FLAG T20	-	-
Z9	US 3510A-T15P	3.0	M 3.5	10.6	-	-	FLAG T15P	-	P-16

Selezione sottoplacchetta









Angolo dell'elica λ	Positivo					Negativo		Per inserti di scanalatura TN16.. ... ZZ, TN22.. ... ZZ
	4.5°	3.5°	2.5°	1.5°	0.5°	-0.5°	-1.5°	
Utensile per filettatura	Sottoplacchetta							
SER16; SIL16	PE16+4.5	PE16+3.5	PE16+2.5	PE16+1.5	PE16+0.5	PE16-0.5	PE16-1.5	PE16ZZ
SEL16; SIR16	PI16+4.5	PI16+3.5	PI16+2.5	PI16+1.5	PI16+0.5	PI16-0.5	PI16-1.5	PI16ZZ
SER22; SIL22	PE22+4.5	PE22+3.5	PE22+2.5	PE22+1.5	PE22+0.5	PE22-0.5	PE22-1.5	PE22ZZ
SEL22; SIR22	PI22+4.5	PI22+3.5	PI22+2.5	PI22+1.5	PI22+0.5	PI22-0.5	PI22-1.5	PI22ZZ
SER-S22; SIL-S22	PE22S+4.5	PE22S+3.5	PE22S+2.5	PE22S+1.5	PE22S+0.5	PE22S-0.5	PE22S-1.5	-
SEL-S22; SIR-S22	PI22S+4.5	PI22S+3.5	PI22S+2.5	PI22S+1.5	PI22S+0.5	PI22S-0.5	PI22S-1.5	-

Nota: di solito gli utensili per filettare hanno un angolo d'inclinazione predisposto $\lambda = 1.5^\circ$. L'angolo d'inclinazione può essere modificato mediante sottoplacchetta intercambiabile. Vedi tabella e diagramma. Sottoplacchetta per utensile SER-S sono marcati con „S“

FILETTATURA



TORNITURA – CONTENUTO GENERALE

 6		WMG & ISO 13399
 10	TORNITURA ISO	ISTRUZIONI
 18		NAVIGATORE
 57		INSERTI POSITIVI
 219		INSERTI NEGATIVI
 386		TRONCATURA E SCANALATURA
 482		FILETTATURA
 528		STOZZATURA
 536		INFORMAZIONI TECNICHE GENERALI

1 TN M INT

	IC (mm)	L (mm)	S (mm)
11	6.350	11.00	3.00
16	9.525	16.50	3.47
22	12.700	22.00	4.71

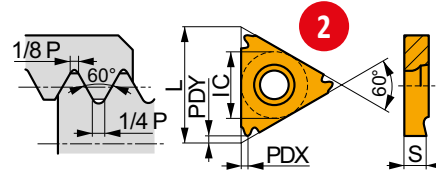

Idoneità e valori iniziali per velocità di taglio (Vc). Fare riferimento alla nostra App Machining Calculator per ulteriori calcoli.

Product	RE (mm)	P	M	K	N	S	H	TP (mm)	TPI	PDX (mm)	PDY (mm)
		vc (m/min)	vc (m/min)	vc (m/min)	vc (m/min)	vc (m/min)	vc (m/min)				

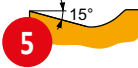

10 TN M NR interno destro, per operazioni di filettatura Metrica, taglio continuo.

TN 11NR050M	T8010	–	■	175	▣	105	■	165	■	–	▣	40	–	0.50	–	0.8	0.8
	T8030	–	■	160	■	95	■	150	▣	–	▣	40	–	0.50	–	0.8	0.8
TN 11NR075M	T8010	–	■	175	▣	105	■	165	■	–	▣	40	–	0.75	–	0.8	0.8
	T8030	–	■	160	■	95	■	150	▣	480	▣	40	–	0.75	–	0.8	0.8
TN 11NR100M	T8010	–	■	175	▣	105	■	165	■	–	▣	40	–	1.00	–	0.8	0.8
	T8030	–	■	160	■	95	■	150	▣	480	▣	40	–	1.00	–	0.8	0.8
TN 11NR125M	T8010	–	■	175	▣	105	■	165	■	–	▣	40	–	1.25	–	0.8	0.8
	T8030	–	■	160	■	95	■	150	▣	480	▣	40	–	1.25	–	0.8	0.8
TN 11NR150M	T8010	–	■	175	▣	105	■	165	■	–	▣	40	–	1.50	–	0.8	0.8
	T8030	–	■	160	■	95	■	150	▣	480	▣	40	–	1.50	–	0.8	0.8
TN 11NR200M	T8010	–	■	175	▣	105	■	165	■	–	▣	40	–	2.00	–	0.9	0.8
	T8030	–	■	160	■	95	■	150	▣	480	▣	40	–	2.00	–	0.9	0.8
TN 16NR050M	T8010	–	■	175	▣	105	■	165	■	–	▣	40	–	0.50	–	0.8	0.8
	T8030	–	■	160	■	95	■	150	▣	480	▣	40	–	0.50	–	0.8	0.8
TN 16NR075M	T8010	–	■	175	▣	105	■	165	■	–	▣	40	–	0.75	–	0.8	0.8
	T8030	–	■	160	■	95	■	150	▣	480	▣	40	–	0.75	–	0.8	0.8
TN 16NR100M	T8010	–	■	175	▣	105	■	165	■	–	▣	40	–	1.00	–	0.8	0.8
	T8030	–	■	160	■	95	■	150	▣	480	▣	40	–	1.00	–	0.8	0.8
TN 16NR125M	T8010	–	■	175	▣	105	■	165	■	–	▣	40	–	1.25	–	0.8	0.8

TN 16NR075M:T8010

Al momento dell'ordine utilizzare il codice di specifica dell'inserto completo!

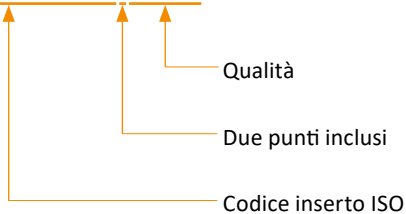

INSERTI DI FILETTATURA – PANORAMICA DELLA PAGINA

Pos.	Descrizione	Pos.	Descrizione
1	Designazione dell'inserto	7	Codice inserto ISO
2	Disegno schematico dell'inserto	8	Qualità
3	Tabella con dimensioni inserto (mm)	9	Raggi dell'inserto (mm)
4	Figura dell'inserto rappresentativo	10	Descrizione geometria
5	Profilo del rompitruciolo	11	Campo di applicazione dell'inserto
6	Icone - caratteristiche specifiche e tipo di tagliente		

UTENSILI PER FILETTATURA – PANORAMICA DELLA PAGINA

1 SI(RL)

P **M** **K** **N** **S** **H** **2**

PRAMET **3** **S**



5 **Utensile per filettatura interna con bloccaggio a vite per inserti TN 11, TN 16 e TN 22**

Utensile destro/sinistro per filettature interne con bloccaggio a vite per inserti di filettatura TN 11, 16 o 22 NR/NL. Adatto per filettature con profilo metrico o in pollici. Diametro interno minimo Ø13 mm. Adatto anche per scanalature poco profonde (anelli Seeger). Disponibile con dimensioni dello stelo da Ø16 a Ø40 mm. Corpi trattati per una maggiore durata.

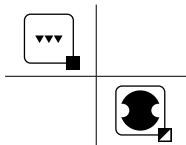
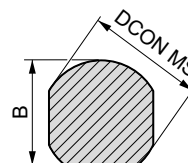
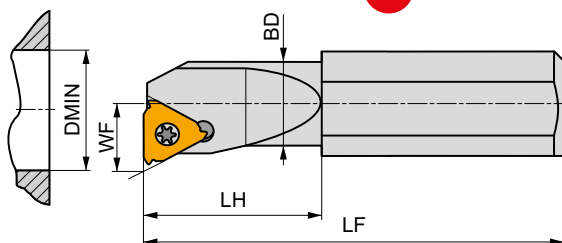
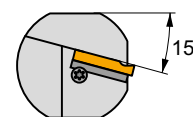
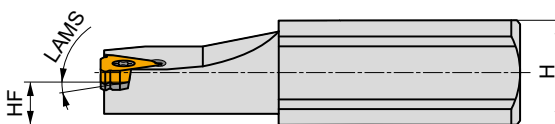
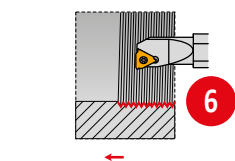

10

Product	B	DCON MS	DMIN	BD	WF	H	HF	LF	LH	LAMS			
	[mm]	[mm]	[mm]	[mm]	[mm]	[mm]	[mm]	[mm]	[mm]	[°]			
SIR 0010 K 11-0	14.5	16	13	10	7.45	14	7	125	25	0	–	GI085	Z11
SIR 0010 K 11-1	14.5	16	13	10	7.45	14	7	125	25	1	–	GI085	Z11
SIR 0013 M 11-0	14.5	16	16	13	9	14	7	150	32	0	–	GI085	Z11
11 SIR 0013 12	14.5	16	16	13	9	14	7	150	32	1	14	15	16
SIR 1416 N 16-0	14	16	22	17	11.4	14.5	7.5	160	–	0	–	GI022	Z9
SIR 1416 N 16-1	14	16	22	17	11.4	14.5	7.5	160	–	1	–	GI022	Z9
R SIR 1416 N 16-2	14	16	16.5	15.5	10.6	14.5	7.5	160	40	2	✓	GI022	Z10
SIR 1820 P 16	18.5	20	27	21	13.85	18	9	170	–	–	–	GI022	Z12
SIR 2325 Q 16	23.5	25	29	26	16.55	23	11.5	180	–	–	–	GI022	Z12
SIR 2532 S 16	30	32	36	32	19.75	25	12.5	250	–	–	–	GI022	Z12
SIR 2532 S 22-2	30	32	25	25	16.65	25	12.5	250	80	2	✓	GI076	Z14
SIR 2532 S 22-A	30	32	36	32	21.65	25	12.5	250	–	–	–	GI076	Z13
SIR 3240 T 22-A	38	40	48	40	25.85	32	16	300	–	–	–	GI076	Z13



17



GI022	TN 16NR..	TN 16NL..
GI076	TN 22NR..	TN 22NL..
GI085	TN 11NR..	TN 11NL..



18



Z10	US 3510A-T15P	3.0	M 3.5	10.6	–	–	FLAG T15P	–	–
Z11	US 2506-T07P	0.9	M 2.5	6.3	–	–	FLAG T07P	–	–
Z12	US 3512A-T15P	3.0	M 3.5	12.7	–	HS 0304	FLAG T15P	HXX 2.5	Page xx
Z13	US 4514A-T20	5.0	M 4.5	14	SP 0405	–	FLAG T20	–	Page xx
Z14	US 4514A-T20	5.0	M 4.5	14	–	–	FLAG T20	–	–
Z9	US 3510A-T15P	3.0	M 3.5	10.6	–	–	FLAG T15P	–	P-16

UTENSILI PER FILETTATURA – PANORAMICA DELLA PAGINA

Pos.	Descrizione
1	Designazione dell'utensile per filettatura
2	Raccomandazioni sul gruppo di materiali
3	Sistema di bloccaggio dell'inserto
4	Figura illustrativa ¹⁾
5	Descrizione dell'utensile
6	Profilo del pezzo da lavorare
7	Disegno schematico dell'utensile
8	Qualità ottenibile della superficie
9	Carattere delle condizioni di taglio/lavorazione

Pos.	Descrizione
10	Applicazioni del prodotto
11	Design dell'utensile
12	Codice ISO del supporto
13	Dimensioni [mm] e angoli ²⁾ [°] dell'utensile
14	Alimentazione interna del refrigerante
15	Gruppo di inserti compatibili ³⁾
16	Gruppo di parti di ricambio ^{3), 4)}
17	Inserti compatibili
18	Parti di ricambio

¹⁾ Gli utensili di tornitura sono di solito rappresentati nella versione destra (R)









²⁾ GAMO = Angolo di spoglia superiore ortogonale (vedere parte tecnica)
LAMS = Angolo di inclinazione del tagliente principale (vedere parte tecnica)

³⁾ Codice gruppo di inserti compatibili, parti di ricambio e accessori speciali sono impiegati solo per esigenze di catalogo e non sono codici validi per ordinazioni.

⁴⁾ Icone di parti di ricambio e di speciali accessori sono rappresentate schematicamente per una facile comprensione. Non sono quindi incluse nella lista di icone. Le viti sono, in alcuni casi, completate con informazioni del momento torcente in Nm, lunghezza e dimensioni del passo.

FILETTATURA – PANORAMICA DELLE ICONE





ICONE GENERALI

 Utilizzo primario	 Finitura – ottima qualità superficiale	 Adatto a condizioni di lavorazione stabili
 Utilizzo possibile	 Lavorazione media – buona qualità superficiale	 Adatto a condizioni di lavorazione instabili
	 Sgrossatura – rugosità superficiale illimitata	 Adatto a condizioni di lavorazione molto instabili

CARATTERISTICHE

 Filettatura – esterna	 Filettatura – interna
--	---

RIVESTIMENTO

 Prima scelta	 Ampia gamma di opzioni universali	 Tagliente affilato
 Per materiali tenaci (truciolo lungo)	 Tagliente arrotondato	

ALTRO

 Coppia di bloccaggio della vite [Nm]	 Alimentazione interna del refrigerante
---	--

M

Profilo completo

TN M EXT *NEW*

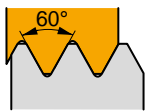

495

TN M INT *NEW*

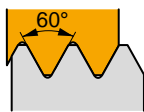

497

M

Profilo parziale

TN 60° PP EXT

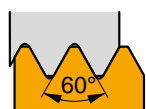

499

TN 60° PP INT

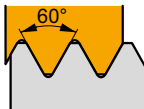

500

TN 60°-S PP EXT

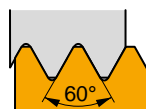

501

TN 60°-S PP INT

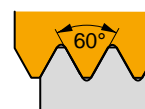

501

MJ

Profilo completo

TN MJ EXT *NEW*

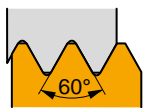

499

UN

Profilo completo

TN UN EXT

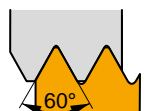

502

TN UN INT

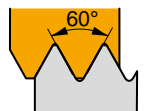

503

UNJ

Profilo completo

TN UNJ EXT *NEW*

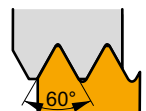

504

W

Profilo completo

TN W EXT

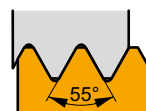

505

TN W INT

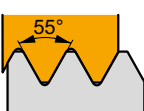

506

W

Profilo parziale

TN 55° PP EXT

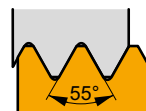

508

TN 55° PP INT

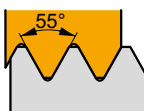

509

BSPT

Profilo completo

TN BSPT EXT

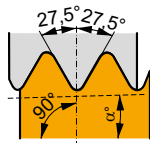

510

TN BSPT INT

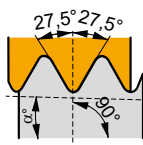

510

NPT

Profilo completo

TN NPT EXT

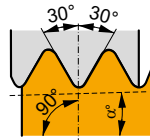

511

TN NPT INT

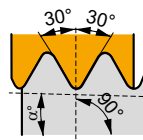

512

TR

Profilo completo

TN TR EXT

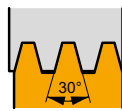

512

TN TR INT

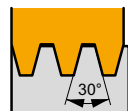

513

TN TR-S EXT

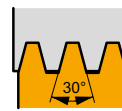

514

TN TR-S INT

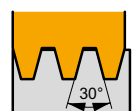

514

ACME

Profilo completo

TN ACME EXT

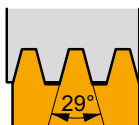

515

TN ACME INT

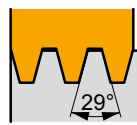

516

STACME

Profilo completo

TN STACME EXT **NEW**

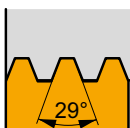

517

TN STACME INT **NEW**

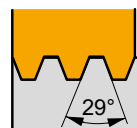

518

API RD

Profilo completo

TN API RD EXT

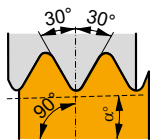

519

TN API RD INT

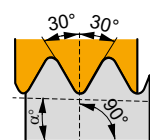

519

RD

Profilo completo

TN RD EXT

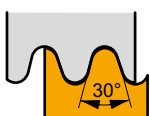

520

TN RD INT

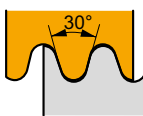

520

QUALITÀ DI FILETTATURA – NAVIGATORE

Identificazione della qualità	Area di applicazione	Applicazione	Avanzamento	Velocità di taglio	Resistenza a condizioni di lavoro avverse	Rivestimento	Colore	Substrato	Vantaggio refrigerante	Descrizione della qualità
T8010	P05 - P15	■				PVD	■	submicron H	+++	Questa qualità è adatta per la tornitura di filetti continua ad alta precisione di acciai, acciai inossidabili, ghise e superleghe. Offre un'eccellente resistenza all'usura assicurando l'affidabilità operativa
	M05 - M15	■								
	K10 - K20	■								
	S10 - S15	■								
T8030	P25 - P40	■				PVD	■	submicron H	+++	Indubbiamente la qualità più versatile, è adatta alla lavorazione di tutti i tipi di materiali lavorati ed è applicabile a quasi tutte le operazioni di tornitura. I suoi principali vantaggi sono l'elevata affidabilità operativa e le eccellenti proprietà di attrito; è quindi adatta ad applicazioni a velocità di taglio medio basse.
	M20 - M35	■								
	K20 - K40	■								
	N15 - N30	■								
	S15 - S25	■								
H15 - H25	■									
HF7	M10 - M20	■				X	■	submicron H	++	Qualità non rivestita, progettata principalmente per la lavorazione di metalli non ferrosi; ma può essere utilizzata anche per altri materiali lavorati (tranne l'acciaio). Questo materiale può essere impiegato per tornitura, fresatura e persino alesatura.
	K10 - K25	■								
	N10 - N25	■								

Substrato

submicron H Substrato a base di WC-Co, a grana fine (< 1 μm)

Rivestimento

PVD Metodo di rivestimento fisico a bassa temperatura

FILETTATURA ISO – ESTERNA

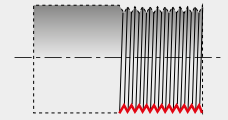

SE(RL)	
TN..	
16 22	
	$\frac{20 \times 20}{32 \times 25}$
522	459 – 521

SE(RL)-S	
TN..	
22	
	$\frac{25 \times 25}{32 \times 25}$
523	459 – 521

FILETTATURA ISO – INTERNA

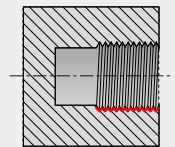

SI(RL)	
TN..	
11 16 22	
	$\frac{13}{48}$
524	459 – 521

SI(RL)-S	
TN..	
22	
	$\frac{39}{48}$
526	459 – 521

INSERTI A FISSAGGIO MECCANICO PER FILETTATURA ISO – DESIGNAZIONE CODICE

ISO	1	2	3	4	5	6	7	-	8
ANSI	T	N	16	E	R	175	M	-	P1
	1	2	3	4	5	6	7		8
	T	N	16	E	R	120	W	-	P1

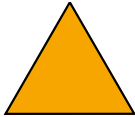
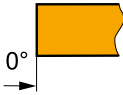
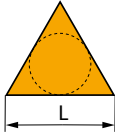
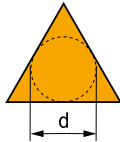
	1	2	3	4																								
	1	2	3	4																								
	Forma inserto	Angolo di spoglia inferiore	Lunghezza del tagliente (dimensione inserto)	Esterno - Interno																								
T			  <table border="1" style="margin: auto; border-collapse: collapse;"> <tr> <td></td> <td style="text-align: center;">L</td> <td></td> <td style="text-align: center;">d = IC</td> </tr> <tr> <td></td> <td style="text-align: center;">(mm)</td> <td style="text-align: center;">(")</td> <td style="text-align: center;">(mm)</td> <td style="text-align: center;">(")</td> </tr> <tr> <td style="text-align: center;">11</td> <td></td> <td style="text-align: center;">.433"</td> <td style="text-align: center;">6,350</td> <td style="text-align: center;">1/4"</td> </tr> <tr> <td style="text-align: center;">16</td> <td></td> <td style="text-align: center;">.650"</td> <td style="text-align: center;">9,525</td> <td style="text-align: center;">3/8"</td> </tr> <tr> <td style="text-align: center;">22</td> <td></td> <td style="text-align: center;">.866"</td> <td style="text-align: center;">12,7</td> <td style="text-align: center;">1/2"</td> </tr> </table>		L		d = IC		(mm)	(")	(mm)	(")	11		.433"	6,350	1/4"	16		.650"	9,525	3/8"	22		.866"	12,7	1/2"	E Esterno
	L		d = IC																									
	(mm)	(")	(mm)	(")																								
11		.433"	6,350	1/4"																								
16		.650"	9,525	3/8"																								
22		.866"	12,7	1/2"																								
				N Interno																								

	5	6	7	7		
	5	6	7	7		
	Direzione di taglio	Passo filetto	Profilo del filetto			
R	Destro	 Passo filetto × 100	M	Metrico 60°		
L	Sinistro	s × 100	MJ	SEA MA1370		
N	Neutro	<table border="1" style="margin: auto; border-collapse: collapse;"> <tr> <td style="text-align: center;">6</td> </tr> <tr> <td style="text-align: center;">N°. di filetti</td> </tr> </table> N° di filetti per pollice × 10	6	N°. di filetti	W	Whitworth 55° ISO 228-1982
6						
N°. di filetti						
			TR	TR 30° ISO 2901/3-1977		
			UN	Americano UN 60° ISO 5864-1978		
			UNJ	SEA AS8879		
			RD	Arrotondato 30°		
			ACME	ACME 29° ANSI B1.5-1988		
			BSPT	ISO 228/1 35 21 1959 ISO 7/1		
			STACME	ASME/ANSI B1.8-1988		
			NPT	ANSI B1.1-1983		
			API RD	API		

	8
	8
	Designazione rompitrucolo
P1	Pressato
AL	Per materiali non ferrosi

DESIGNAZIONE CODICE ISO – UTENSILI PER FILETTATURA

ISO	1 S	2 E	3 R	-	4 S	5 2525	6 M	7 16	-	8
ANSI	1 S	2 E	3 R	-	4 S	5 16	6 D	7 16	-	8

1		2		3		4	
Tipo di bloccaggio		Tipo di lavorazione		Direzione di taglio		Tipo di costruzione	
C		E	Esterna	R	Destra	Esterna	
	P						
M		I	Interna	L	Sinistra	Esterna	
	S						
						-	Standard
						S	Speciale

5		6		7			
Dimensioni utensile (mm)		Lunghezza totale utensile (mm)		Lunghezza del tagliente (dimensione inserto)			
Tornitura esterna	2525	25 × 25 mm			LF (mm)		
					K	125	
Tornitura interna	1416	Diametro anteriore – 14 mm Diametro stelo Ø – 16 mm			L	140	
						M	150
						N	160
						P	170
						Q	180
						R	200
						S	250
						T	300
						d = IC	
						T	
						(mm)	(")
						6.350	1/4"
						9.525	3/8"
						12.700	1/2"
						11	
						16	
						22	

5		6		8				
Dimensioni utensile (")		Lunghezza totale utensile (")		Angolo di inclinazione dell'elica λ				
	10	5/8"	5/8"		0	Angolo di inclinazione dell'elica λ = 0°		
	12	3/4"	3/4"					
	16	1"	1"					
	85	1"	1 1/4"					
	86	1"	1 1/2"					
	20	1 1/4"	1 1/4"					
	DCON (")			1	Angolo di inclinazione dell'elica λ = 1°			
	08	.500"						
	10	.625"						
	12	.750"						
	16	1.000"						
	20	1.250"						
	24	1.500"						
							2	Angolo di inclinazione dell'elica λ = 2°
	C	5.000"						
	D	6.000"						
E	7.000"							
			F					
K	5.000"							
M	6.000"							
P	6.250"							
			Q					
R	8.000"							
S	10.000"							
T	12.000"							
			U					
14.000"								

NEW

TN M EXT



	IC (mm)	L (mm)	S (mm)
16	9.525	16.50	3.47
22	12.700	22.00	4.71

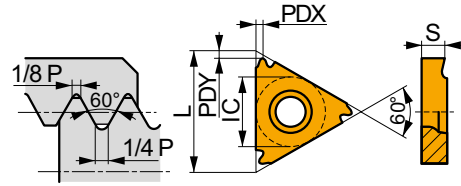

Idoneità e valori iniziali per velocità di taglio (Vc). Fare riferimento alla nostra App Machining Calculator per ulteriori calcoli.

Codice prodotto	RE (mm)	P	M	K	N	S	H	TP (mm)	TPI	PDX (mm)	PDY (mm)
		vc (m/min)	vc (m/min)	vc (m/min)	vc (m/min)	vc (m/min)	vc (m/min)				

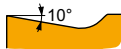

TN M ER esterno destro, per operazioni di filettatura Metrica, taglio continuo.

TN 16ER050M	T8010	-	█	175	█	105	█	165	-	█	40	-	0.50	-	0.8	0.8	
	T8030	-	█	160	█	95	█	150	█	480	█	40	-	0.50	-	0.8	0.8
TN 16ER075M	T8010	-	█	175	█	105	█	165	-	█	40	-	0.75	-	0.8	0.8	
	T8030	-	█	160	█	95	█	150	█	480	█	40	-	0.75	-	0.8	0.8
TN 16ER080M	T8010	-	█	175	█	105	█	165	-	█	40	-	0.80	-	0.6	0.8	
	T8030	-	█	160	█	95	█	150	█	480	█	40	-	0.80	-	0.6	0.8
TN 16ER100M	T8010	-	█	175	█	105	█	165	-	█	40	-	1.00	-	0.8	0.8	
	T8030	-	█	160	█	95	█	150	█	480	█	40	-	1.00	-	0.8	0.8
TN 16ER125M	T8010	-	█	175	█	105	█	165	-	█	40	-	1.25	-	0.8	0.8	
	T8030	-	█	160	█	95	█	150	█	480	█	40	-	1.25	-	0.8	0.8
TN 16ER150M	T8010	-	█	175	█	105	█	165	-	█	40	-	1.50	-	0.8	0.8	
	T8030	-	█	160	█	95	█	150	█	480	█	40	-	1.50	-	0.8	0.8
TN 16ER175M	T8010	-	█	175	█	105	█	165	-	█	40	-	1.75	-	1.5	1.2	
	T8030	-	█	160	█	95	█	150	█	480	█	40	-	1.75	-	1.5	1.2
TN 16ER200M	T8010	-	█	175	█	105	█	165	-	█	40	-	2.00	-	1.5	1.2	
	T8030	-	█	160	█	95	█	150	█	480	█	40	-	2.00	-	1.5	1.2
TN 16ER250M	T8010	-	█	175	█	105	█	165	-	█	40	-	2.50	-	1.5	1.2	
	T8030	-	█	160	█	95	█	150	█	480	█	40	-	2.50	-	1.5	1.2
TN 16ER300M	T8010	-	█	175	█	105	█	165	-	█	40	-	3.00	-	1.5	1.2	
	T8030	-	█	160	█	95	█	150	█	480	█	40	-	3.00	-	1.5	1.2
TN 16ER350M	T8030 ¹⁾	-	█	160	█	95	█	150	█	480	█	40	-	3.50	-	1.7	1.2
TN 22ER350M	T8010	-	█	175	█	105	█	165	-	█	40	-	3.50	-	2.5	1.8	
	T8030	-	█	160	█	95	█	150	█	480	█	40	-	3.50	-	2.5	1.8
TN 22ER400M	T8010	-	█	175	█	105	█	165	-	█	40	-	4.00	-	2.5	1.8	
	T8030	-	█	160	█	95	█	150	█	480	█	40	-	4.00	-	2.5	1.8
TN 22ER450M	T8010	-	█	175	█	105	█	165	-	█	40	-	4.50	-	2.5	1.8	
	T8030	-	█	160	█	95	█	150	█	480	█	40	-	4.50	-	2.5	1.8
TN 22ER500M	T8010	-	█	175	█	105	█	165	-	█	40	-	5.00	-	2.5	1.8	
	T8030	-	█	160	█	95	█	150	█	480	█	40	-	5.00	-	2.5	1.8



TN M EL esterno sinistro, per operazioni di filettatura Metrica, taglio continuo.

TN 16EL050M	T8030	-	█	160	█	95	█	150	█	480	█	40	-	0.50	-	0.8	0.8
TN 16EL075M	T8030	-	█	160	█	95	█	150	█	480	█	40	-	0.75	-	0.8	0.8
TN 16EL080M	T8030	-	█	160	█	95	█	150	█	480	█	40	-	0.80	-	0.6	0.8
TN 16EL100M	T8010	-	█	175	█	105	█	165	-	█	40	-	1.00	-	0.8	0.8	
	T8030	-	█	160	█	95	█	150	█	480	█	40	-	1.00	-	0.8	0.8
TN 16EL125M	T8010	-	█	175	█	105	█	165	-	█	40	-	1.25	-	0.8	0.8	
	T8030	-	█	160	█	95	█	150	█	480	█	40	-	1.25	-	0.8	0.8

Idoneità e valori iniziali per velocità di taglio (Vc). Fare riferimento alla nostra App Machining Calculator per ulteriori calcoli.

Codice prodotto	RE (mm)	P	M	K	N	S	H	TP	TPI	PDX	PDY

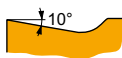
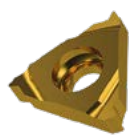

TN M EL esterno sinistro, per operazioni di filettatura Metrica, taglio continuo.

TN 16EL150M	T8010	–	■	175	▣	105	■	165	▣	–	▣	40	–	–	1.50	–	0.8	0.8
	T8030	–	■	160	■	95	■	150	▣	480	▣	40	–	–	1.50	–	0.8	0.8
TN 16EL175M	T8010	–	■	175	▣	105	■	165	–	–	▣	40	–	–	1.75	–	1.5	1.2
	T8030	–	■	160	▣	95	■	150	▣	480	▣	40	–	–	1.75	–	1.5	1.2
TN 16EL200M	T8010	–	■	175	▣	105	■	165	–	–	▣	40	–	–	2.00	–	1.5	1.2
	T8030	–	■	160	■	95	■	150	▣	480	▣	40	–	–	2.00	–	1.5	1.2
TN 16EL250M	T8010	–	■	175	▣	105	■	165	–	–	▣	40	–	–	2.50	–	1.5	1.2
	T8030	–	■	160	■	95	■	150	▣	480	▣	40	–	–	2.50	–	1.5	1.2
TN 16EL300M	T8010	–	■	175	▣	105	■	165	–	–	▣	40	–	–	3.00	–	1.5	1.2
	T8030	–	■	160	■	95	■	150	▣	480	▣	40	–	–	3.00	–	1.5	1.2
TN 16EL350M	T8030 ¹⁾	–	■	160	■	95	■	150	▣	480	▣	40	–	–	3.50	–	1.7	1.2
TN 22EL350M	T8030	–	■	160	■	95	■	150	▣	480	▣	40	–	–	3.50	–	2.5	1.8
TN 22EL400M	T8030	–	■	160	■	95	■	150	▣	480	▣	40	–	–	4.00	–	2.5	1.8
TN 22EL450M	T8030	–	■	160	■	95	■	150	▣	480	▣	40	–	–	4.50	–	2.5	1.8
TN 22EL500M	T8030	–	■	160	■	95	■	150	▣	480	▣	40	–	–	5.00	–	2.5	1.8

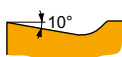

TN M-P1 ER esterno destro, geometria stampata di precisione, per operazioni di filettatura ISO Metrica, taglio continuo.

TN 16ER100M-P1	T8030	–	■	160	■	95	■	150	▣	480	▣	40	–	–	1.00	–	0.8	0.8
TN 16ER125M-P1	T8030	–	■	160	■	95	■	150	▣	480	▣	40	–	–	1.25	–	0.8	0.8
TN 16ER150M-P1	T8030	–	■	160	■	95	■	150	▣	480	▣	40	–	–	1.50	–	0.8	0.8
TN 16ER175M-P1	T8030	–	■	160	■	95	■	150	▣	480	▣	40	–	–	1.75	–	1.5	1.2
TN 16ER200M-P1	T8030	–	■	160	■	95	■	150	▣	480	▣	40	–	–	2.00	–	1.5	1.2
TN 16ER250M-P1	T8030	–	■	160	■	95	■	150	▣	480	▣	40	–	–	2.50	–	1.5	1.2
TN 16ER300M-P1	T8030	–	■	160	■	95	■	150	▣	480	▣	40	–	–	3.00	–	1.5	1.2

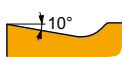
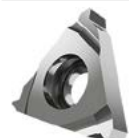

TN M-AL ER esterno destro, per operazioni di filettatura ISO Metrica, taglio continuo.

TN 16ER050M-AL	HF7	–	■	–	▣	95	■	–	■	480	–	–	–	–	0.50	–	0.8	0.8
TN 16ER075M-AL	HF7	–	■	–	▣	95	■	–	■	480	–	–	–	–	0.75	–	0.8	0.8
TN 16ER080M-AL	HF7	–	■	–	▣	95	■	–	■	480	–	–	–	–	0.80	–	0.6	0.8
TN 16ER100M-AL	HF7	–	■	–	▣	95	■	–	■	480	–	–	–	–	1.00	–	0.8	0.8
TN 16ER125M-AL	HF7	–	■	–	▣	95	■	–	■	480	–	–	–	–	1.25	–	0.8	0.8
TN 16ER150M-AL	HF7	–	■	–	▣	95	■	–	■	480	–	–	–	–	1.50	–	0.8	0.8
TN 16ER175M-AL	HF7	–	■	–	▣	95	■	–	■	480	–	–	–	–	1.75	–	1.5	1.2
TN 16ER200M-AL	HF7	–	■	–	▣	95	■	–	■	480	–	–	–	–	2.00	–	1.5	1.2
TN 16ER250M-AL	HF7	–	■	–	▣	95	■	–	■	480	–	–	–	–	2.50	–	1.5	1.2
TN 16ER300M-AL	HF7	–	■	–	▣	95	■	–	■	480	–	–	–	–	3.00	–	1.5	1.2

¹⁾ I portautensili devono essere modificati.

NEW

TN M INT

PRAMET

	IC (mm)	L (mm)	S (mm)
11	6.350	11.00	3.00
16	9.525	16.50	3.47
22	12.700	22.00	4.71

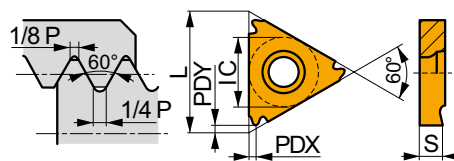

Idoneità e valori iniziali per velocità di taglio (Vc). Fare riferimento alla nostra App Machining Calculator per ulteriori calcoli.

Codice prodotto	RE (mm)	P	M	K	N	S	H	TP (mm)	TPI	PDX (mm)	PDY (mm)
		vc (m/min)	vc (m/min)	vc (m/min)	vc (m/min)	vc (m/min)	vc (m/min)				

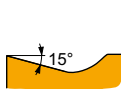

TN M NR interno destro, per operazioni di filettatura Metrica, taglio continuo.

TN 11NR050M	T8010	-	█	175	█	105	█	165	-	█	40	-	0.50	-	0.8	0.8	
	T8030	-	█	160	█	95	█	150	█	480	█	40	-	0.50	-	0.8	0.8
TN 11NR075M	T8010	-	█	175	█	105	█	165	-	█	40	-	0.75	-	0.8	0.8	
	T8030	-	█	160	█	95	█	150	█	480	█	40	-	0.75	-	0.8	0.8
TN 11NR100M	T8010	-	█	175	█	105	█	165	-	█	40	-	1.00	-	0.8	0.8	
	T8030	-	█	160	█	95	█	150	█	480	█	40	-	1.00	-	0.8	0.8
TN 11NR125M	T8010	-	█	175	█	105	█	165	-	█	40	-	1.25	-	0.8	0.8	
	T8030	-	█	160	█	95	█	150	█	480	█	40	-	1.25	-	0.8	0.8
TN 11NR150M	T8010	-	█	175	█	105	█	165	-	█	40	-	1.50	-	0.8	0.8	
	T8030	-	█	160	█	95	█	150	█	480	█	40	-	1.50	-	0.8	0.8
TN 11NR200M	T8010	-	█	175	█	105	█	165	-	█	40	-	2.00	-	0.9	0.8	
	T8030	-	█	160	█	95	█	150	█	480	█	40	-	2.00	-	0.9	0.8
TN 16NR050M	T8010	-	█	175	█	105	█	165	-	█	40	-	0.50	-	0.8	0.8	
	T8030	-	█	160	█	95	█	150	█	480	█	40	-	0.50	-	0.8	0.8
TN 16NR075M	T8010	-	█	175	█	105	█	165	-	█	40	-	0.75	-	0.8	0.8	
	T8030	-	█	160	█	95	█	150	█	480	█	40	-	0.75	-	0.8	0.8
TN 16NR100M	T8010	-	█	175	█	105	█	165	-	█	40	-	1.00	-	0.8	0.8	
	T8030	-	█	160	█	95	█	150	█	480	█	40	-	1.00	-	0.8	0.8
TN 16NR125M	T8010	-	█	175	█	105	█	165	-	█	40	-	1.25	-	0.8	0.8	
	T8030	-	█	160	█	95	█	150	█	480	█	40	-	1.25	-	0.8	0.8
TN 16NR150M	T8010	-	█	175	█	105	█	165	-	█	40	-	1.50	-	0.8	0.8	
	T8030	-	█	160	█	95	█	150	█	480	█	40	-	1.50	-	0.8	0.8
TN 16NR175M	T8010	-	█	175	█	105	█	165	-	█	40	-	1.75	-	1.5	1.2	
	T8030	-	█	160	█	95	█	150	█	480	█	40	-	1.75	-	1.5	1.2
TN 16NR200M	T8010	-	█	175	█	105	█	165	-	█	40	-	2.00	-	1.5	1.2	
	T8030	-	█	160	█	95	█	150	█	480	█	40	-	2.00	-	1.5	1.2
TN 16NR250M	T8010	-	█	175	█	105	█	165	-	█	40	-	2.50	-	1.5	1.2	
	T8030	-	█	160	█	95	█	150	█	480	█	40	-	2.50	-	1.5	1.2
TN 16NR300M	T8010	-	█	175	█	105	█	165	-	█	40	-	3.00	-	1.5	1.2	
	T8030	-	█	160	█	95	█	150	█	480	█	40	-	3.00	-	1.5	1.2
TN 16NR350M	T8030 ¹⁾	-	█	160	█	95	█	150	█	480	█	40	-	3.50	-	1.6	1.2
TN 22NR350M	T8010	-	█	175	█	105	█	165	-	█	40	-	3.50	-	2.5	1.8	
	T8030	-	█	160	█	95	█	150	█	480	█	40	-	3.50	-	2.5	1.8
TN 22NR400M	T8010	-	█	175	█	105	█	165	-	█	40	-	4.00	-	2.5	1.8	
	T8030	-	█	160	█	95	█	150	█	480	█	40	-	4.00	-	2.5	1.8
TN 22NR450M	T8010	-	█	175	█	105	█	165	-	█	40	-	4.50	-	2.5	1.8	
	T8030	-	█	160	█	95	█	150	█	480	█	40	-	4.50	-	2.5	1.8
TN 22NR500M	T8010	-	█	175	█	105	█	165	-	█	40	-	5.00	-	2.5	1.8	
	T8030	-	█	160	█	95	█	150	█	480	█	40	-	5.00	-	2.5	1.8

Idoneità e valori iniziali per velocità di taglio (Vc). Fare riferimento alla nostra App Machining Calculator per ulteriori calcoli.

Codice prodotto	RE (mm)	P	M	K	N	S	H	TP	TPI	PDX	PDY



TN M NL interno sinistro, per operazioni di filettatura Metrica, taglio continuo.

TN 11NL050M	T8030	–	■	160	■	95	■	150	▣	480	▣	40	–	0.50	–	0.8	0.8
TN 11NL075M	T8030	–	■	160	■	95	■	150	▣	480	▣	40	–	0.75	–	0.8	0.8
TN 11NL100M	T8030	–	■	160	■	95	■	150	▣	480	▣	40	–	1.00	–	0.8	0.8
TN 11NL125M	T8030	–	■	160	■	95	■	150	▣	480	▣	40	–	1.25	–	0.8	0.8
TN 11NL150M	T8010	–	■	175	▣	105	■	165	–	–	▣	40	–	1.50	–	0.8	0.8
	T8030	–	■	160	■	95	■	150	▣	480	▣	40	–	1.50	–	0.8	0.8
TN 11NL200M	T8010	–	■	175	▣	105	■	165	–	–	▣	40	–	2.00	–	0.9	0.8
	T8030	–	■	160	■	95	■	150	▣	480	▣	40	–	2.00	–	0.9	0.8
TN 16NL050M	T8030	–	■	160	■	95	■	150	▣	480	▣	40	–	0.50	–	0.8	0.8
TN 16NL075M	T8030	–	■	160	■	95	■	150	▣	480	▣	40	–	0.75	–	0.8	0.8
TN 16NL100M	T8010	–	■	175	▣	105	■	165	–	–	▣	40	–	1.00	–	0.8	0.8
	T8030	–	■	160	■	95	■	150	▣	480	▣	40	–	1.00	–	0.8	0.8
TN 16NL125M	T8010	–	■	175	▣	105	■	165	–	–	▣	40	–	1.25	–	0.8	0.8
	T8030	–	■	160	■	95	■	150	▣	480	▣	40	–	1.25	–	0.8	0.8
TN 16NL150M	T8010	–	■	175	▣	105	■	165	–	–	▣	40	–	1.50	–	0.8	0.8
	T8030	–	■	160	■	95	■	150	▣	480	▣	40	–	1.50	–	0.8	0.8
TN 16NL175M	T8010	–	■	175	▣	105	■	165	–	–	▣	40	–	1.75	–	1.5	1.2
	T8030	–	■	160	■	95	■	150	▣	480	▣	40	–	1.75	–	1.5	1.2
TN 16NL200M	T8010	–	■	175	▣	105	■	165	–	–	▣	40	–	2.00	–	1.5	1.2
	T8030	–	■	160	■	95	■	150	▣	480	▣	40	–	2.00	–	1.5	1.2
TN 16NL250M	T8010	–	■	175	▣	105	■	165	–	–	▣	40	–	2.50	–	1.5	1.2
	T8030	–	■	160	■	95	■	150	▣	480	▣	40	–	2.50	–	1.5	1.2
TN 16NL300M	T8010	–	■	175	▣	105	■	165	–	–	▣	40	–	3.00	–	1.5	1.2
	T8030	–	■	160	■	95	■	150	▣	480	▣	40	–	3.00	–	1.5	1.2
TN 16NL350M	T8030 ¹⁾	–	■	160	■	95	■	150	▣	480	▣	40	–	3.50	–	1.6	1.2
TN 22NL350M	T8030	–	■	160	■	95	■	150	▣	480	▣	40	–	3.50	–	2.5	1.8
TN 22NL400M	T8030	–	■	160	■	95	■	150	▣	480	▣	40	–	4.00	–	2.5	1.8
TN 22NL500M	T8030	–	■	160	■	95	■	150	▣	480	▣	40	–	5.00	–	2.5	1.8



TN M-P1 NR interno destro, geometria stampata di precisione, per operazioni di filettatura ISO Metrica, taglio continuo.

TN 11NR100M-P1	T8030	–	■	160	■	95	■	150	▣	480	▣	40	–	1.00	–	0.8	0.8
TN 11NR150M-P1	T8030	–	■	160	■	95	■	150	▣	480	▣	40	–	1.50	–	0.8	0.8
TN 16NR100M-P1	T8030	–	■	160	■	95	■	150	▣	480	▣	40	–	1.00	–	0.8	0.8
TN 16NR150M-P1	T8030	–	■	160	■	95	■	150	▣	480	▣	40	–	1.50	–	0.8	0.8
TN 16NR200M-P1	T8030	–	■	160	■	95	■	150	▣	480	▣	40	–	2.00	–	1.5	1.2
TN 16NR250M-P1	T8030	–	■	160	■	95	■	150	▣	480	▣	40	–	2.50	–	1.5	1.2
TN 16NR300M-P1	T8030	–	■	160	■	95	■	150	▣	480	▣	40	–	3.00	–	1.5	1.2

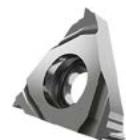

TN M-AL NR interno destro, per operazioni di filettatura ISO Metrica, taglio continuo.

TN 16NR050M-AL	HF7	–	■	–	▣	95	■	–	■	480	–	–	–	0.50	–	0.8	0.8
TN 16NR075M-AL	HF7	–	■	–	▣	95	■	–	■	480	–	–	–	0.75	–	0.8	0.8
TN 16NR100M-AL	HF7	–	■	–	▣	95	■	–	■	480	–	–	–	1.00	–	0.8	0.8
TN 16NR125M-AL	HF7	–	■	–	▣	95	■	–	■	480	–	–	–	1.25	–	0.8	0.8
TN 16NR150M-AL	HF7	–	■	–	▣	95	■	–	■	480	–	–	–	1.50	–	0.8	0.8
TN 16NR175M-AL	HF7	–	■	–	▣	95	■	–	■	480	–	–	–	1.75	–	1.5	1.2
TN 16NR200M-AL	HF7	–	■	–	▣	95	■	–	■	480	–	–	–	2.00	–	1.5	1.2
TN 16NR250M-AL	HF7	–	■	–	▣	95	■	–	■	480	–	–	–	2.50	–	1.5	1.2
TN 16NR300M-AL	HF7	–	■	–	▣	95	■	–	■	480	–	–	–	3.00	–	1.5	1.2

¹⁾ I portautensili devono essere modificati.

NEW**TN MJ EXT**

PRAMET

	IC (mm)	L (mm)	S (mm)
16	9.525	16.50	3.47

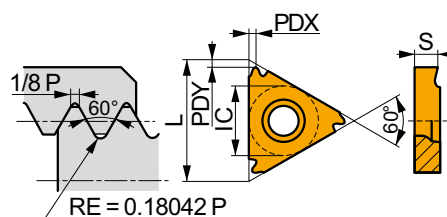

Idoneità e valori iniziali per velocità di taglio (Vc). Fare riferimento alla nostra App Machining Calculator per ulteriori calcoli.

Codice prodotto	RE (mm)	P	M	K	N	S	H	TP (mm)	TPI	PDX (mm)	PDY (mm)
		vc (m/min)	vc (m/min)	vc (m/min)	vc (m/min)	vc (m/min)	vc (m/min)				

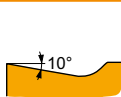

TN MJ ER esterno destro, per operazioni di filettatura Metrica "forma J", taglio continuo.

TN 16ER100MJ	T8030	-	■	160	■	95	■	150	■	480	■	40	-	1.00	-	0.8	0.8
TN 16ER150MJ	T8030	-	■	160	■	95	■	150	■	480	■	40	-	1.50	-	0.8	0.8

TN 60° PP EXT

PRAMET

	IC (mm)	L (mm)	S (mm)
16	9.525	16.50	3.47
22	12.700	22.00	4.71

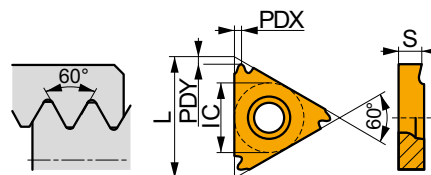

Idoneità e valori iniziali per velocità di taglio (Vc). Fare riferimento alla nostra App Machining Calculator per ulteriori calcoli.

Codice prodotto	RE (mm)	P	M	K	N	S	H	TPN (mm)	TPX (mm)	TPIN	TPIX	PDX (mm)	PDY (mm)
		vc (m/min)	vc (m/min)	vc (m/min)	vc (m/min)	vc (m/min)	vc (m/min)						

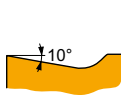

TN M60 PP ER esterno destro, per operazioni di filettatura Metrica e Unificata, taglio continuo.

TN 16ERA60	T8010	-	■	175	■	105	■	165	-	■	40	-	0.50	1.50	16	48	0.8	0.6
	T8030	-	■	160	■	95	■	150	■	480	■	40	-	0.50	1.50	16	48	0.8
TN 16ERAG60	T8010	-	■	175	■	105	■	165	-	■	40	-	0.50	3.00	8	48	1.5	1.1
	T8030	-	■	160	■	95	■	150	■	480	■	40	-	0.50	3.00	8	48	1.5
TN 16ERG60	T8010	-	■	175	■	105	■	165	-	■	40	-	1.75	3.00	8	14	1.5	1.1
	T8030	-	■	160	■	95	■	150	■	480	■	40	-	1.75	3.00	8	14	1.5
TN 22ERN60	T8010	-	■	175	■	105	■	165	-	■	40	-	3.50	5.00	5	7	2.5	1.8
	T8030	-	■	160	■	95	■	150	■	480	■	40	-	3.50	5.00	5	7	2.5

Idoneità e valori iniziali per velocità di taglio (Vc). Fare riferimento alla nostra App Machining Calculator per ulteriori calcoli.

Codice prodotto	RE (mm)	P	M	K	N	S	H	TPN	TPX	TPIN	TPIX	PDX	PDY

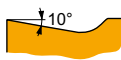

TN M60 PP EL esterno sinistro, per operazioni di filettatura Metrica e Unificata, taglio continuo.

TN 16ELA60	T8030	–	■	160	■	95	■	150	▣	480	▣	40	–	0.50	1.50	16	48	0.8	0.6
TN 16ELAG60	T8010	–	■	175	▣	105	■	165	–	–	▣	40	–	0.50	3.00	8	48	1.5	1.1
	T8030	–	■	160	■	95	■	150	▣	480	▣	40	–	0.50	3.00	8	48	1.5	1.1
TN 16ELG60	T8030	–	■	160	■	95	■	150	▣	480	▣	40	–	1.75	3.00	8	14	1.5	1.1
TN 22ELN60	T8030	–	■	160	■	95	■	150	▣	480	▣	40	–	3.50	5.00	5	7	2.5	1.8

TN 60° PP INT

PRAMET

	IC (mm)	L (mm)	S (mm)
11	6.350	11.00	3.00
16	9.525	16.50	3.47
22	12.700	22.00	4.71

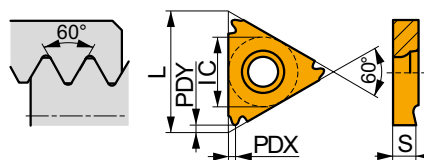

Idoneità e valori iniziali per velocità di taglio (Vc). Fare riferimento alla nostra App Machining Calculator per ulteriori calcoli.

Codice prodotto	RE (mm)	P	M	K	N	S	H	TPN	TPX	TPIN	TPIX	PDX	PDY

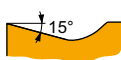

TN M60 PP NR interno destro, per operazioni di filettatura Metrica e Unificata, taglio continuo.

TN 11NRA60	T8010	–	■	175	▣	105	■	165	–	–	▣	40	–	0.50	1.50	16	48	0.8	0.7
	T8030	–	■	160	■	95	■	150	▣	480	▣	40	–	0.50	1.50	16	48	0.8	0.7
TN 16NRA60	T8010	–	■	175	▣	105	■	165	–	–	▣	40	–	0.50	1.50	16	48	0.8	0.7
	T8030	–	■	160	■	95	■	150	▣	480	▣	40	–	0.50	1.50	16	48	0.8	0.7
TN 16NRAG60	T8010	–	■	175	▣	105	■	165	–	–	▣	40	–	0.50	3.00	8	48	1.5	1.1
	T8030	–	■	160	■	95	■	150	▣	480	▣	40	–	0.50	3.00	8	48	1.5	1.1
TN 16NRG60	T8010	–	■	175	▣	105	■	165	–	–	▣	40	–	1.75	3.00	8	14	1.5	1.1
	T8030	–	■	160	■	95	■	150	▣	480	▣	40	–	1.75	3.00	8	14	1.5	1.1
TN 22NRN60	T8010	–	■	175	▣	105	■	165	–	–	▣	40	–	3.50	5.00	5	7	2.5	1.8
	T8030	–	■	160	■	95	■	150	▣	480	▣	40	–	3.50	5.00	5	7	2.5	1.8



TN M60 PP NL interno sinistro, per operazioni di filettatura Metrica e Unificata, taglio continuo.

TN 11NLA60	T8030	–	■	160	■	95	■	150	▣	480	▣	40	–	0.50	1.50	16	48	0.8	0.7
TN 16NLA60	T8030	–	■	160	■	95	■	150	▣	480	▣	40	–	0.50	1.50	16	48	0.8	0.7
TN 16NLAG60	T8010	–	■	175	▣	105	■	165	–	–	▣	40	–	0.50	3.00	8	48	1.5	1.1
	T8030	–	■	160	■	95	■	150	▣	480	▣	40	–	0.50	3.00	8	48	1.5	1.1
TN 16NLG60	T8030	–	■	160	■	95	■	150	▣	480	▣	40	–	1.75	3.00	8	14	1.5	1.1
TN 22NLN60	T8030	–	■	160	■	95	■	150	▣	480	▣	40	–	3.50	5.00	5	7	2.5	1.8

TN 60°-S PP EXT

PRAMET

	IC (mm)	L (mm)	S (mm)
22	12.700	22.00	4.60

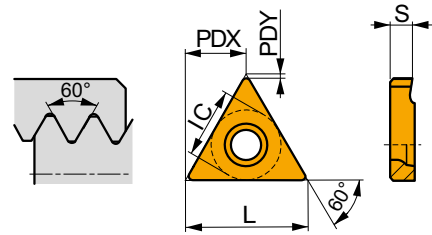

Idoneità e valori iniziali per velocità di taglio (Vc). Fare riferimento alla nostra App Machining Calculator per ulteriori calcoli.

Codice prodotto	RE (mm)	P	M	K	N	S	H	TPN (mm)	TPX (mm)	TPIN (mm)	TPIX (mm)	PDX (mm)	PDY (mm)
		vc (m/min)	vc (m/min)	vc (m/min)	vc (m/min)	vc (m/min)	vc (m/min)						

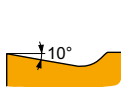

TN M60-S PP EN esterno con design neutro (destra e sinistra), per operazioni di filettatura Metrica e Unificata, taglio continuo.

TN 22EN350-500M	T8030	-	■	160	■	95	■	150	☑	480	☑	40	-	3.50	5.00	5	7	11.0	0.5
TN 22EN550-800M	T8030	-	■	160	■	95	■	150	☑	480	☑	40	-	5.50	8.00	3	4.5	11.0	0.8

TN 60°-S PP INT

PRAMET

	IC (mm)	L (mm)	S (mm)
22	12.700	22.00	4.60

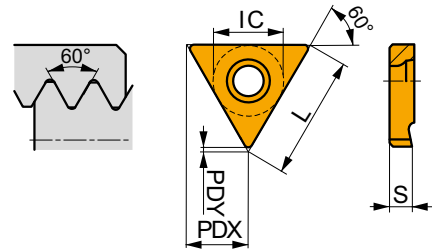

Idoneità e valori iniziali per velocità di taglio (Vc). Fare riferimento alla nostra App Machining Calculator per ulteriori calcoli.

Codice prodotto	RE (mm)	P	M	K	N	S	H	TPN (mm)	TPX (mm)	TPIN (mm)	TPIX (mm)	PDX (mm)	PDY (mm)
		vc (m/min)	vc (m/min)	vc (m/min)	vc (m/min)	vc (m/min)	vc (m/min)						

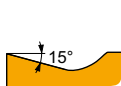
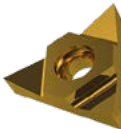

TN M60-S PP NN interno con design neutro (destra e sinistra), per operazioni di filettatura Metrica e Unificata, taglio continuo.

TN 22NN350-500M	T8030	-	■	160	■	95	■	150	☑	480	☑	40	-	3.50	5.00	5	7	11.0	0.2
TN 22NN550-800M	T8030	-	■	160	■	95	■	150	☑	480	☑	40	-	5.50	8.00	3	4.5	11.0	0.5

TN UN EXT

	IC (mm)	L (mm)	S (mm)
16	9.525	16.50	3.47
22	12.700	22.00	4.71

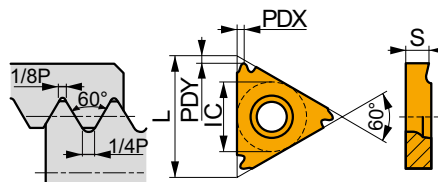

Idoneità e valori iniziali per velocità di taglio (Vc). Fare riferimento alla nostra App Machining Calculator per ulteriori calcoli.

Codice prodotto	RE (mm)	P	M	K	N	S	H	TP (mm)	TPI	PDX (mm)	PDY (mm)
		vc (m/min)	vc (m/min)	vc (m/min)	vc (m/min)	vc (m/min)	vc (m/min)				

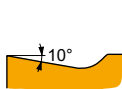

TN UN ER esterno destro, per operazioni di filettatura Unificata, taglio continuo.

TN 16ER320UN	T8030	–	■	160	■	95	■	150	■	480	■	40	–	–	32.0	0.8	0.8
TN 16ER280UN	T8030	–	■	160	■	95	■	150	■	480	■	40	–	–	28.0	0.8	0.8
TN 16ER240UN	T8030	–	■	160	■	95	■	150	■	480	■	40	–	–	24.0	0.8	0.8
TN 16ER200UN	T8010	–	■	175	■	105	■	165	■	–	■	40	–	–	20.0	0.8	0.8
	T8030	–	■	160	■	95	■	150	■	480	■	40	–	–	20.0	0.8	0.8
TN 16ER180UN	T8030	–	■	160	■	95	■	150	■	480	■	40	–	–	18.0	0.8	0.8
TN 16ER160UN	T8030	–	■	160	■	95	■	150	■	480	■	40	–	–	16.0	0.8	0.8
TN 16ER140UN	T8030	–	■	160	■	95	■	150	■	480	■	40	–	–	14.0	1.5	1.2
TN 16ER130UN	T8030	–	■	160	■	95	■	150	■	480	■	40	–	–	13.0	1.5	1.2
TN 16ER120UN	T8030	–	■	160	■	95	■	150	■	480	■	40	–	–	12.0	1.5	1.2
TN 16ER115UN	T8030	–	■	160	■	95	■	150	■	480	■	40	–	–	11.5	1.5	1.2
TN 16ER110UN	T8030	–	■	160	■	95	■	150	■	480	■	40	–	–	11.0	1.5	1.2
TN 16ER100UN	T8030	–	■	160	■	95	■	150	■	480	■	40	–	–	10.0	1.5	1.2
TN 16ER090UN	T8030	–	■	160	■	95	■	150	■	480	■	40	–	–	9.0	1.5	1.2
TN 16ER080UN	T8030	–	■	160	■	95	■	150	■	480	■	40	–	–	8.0	1.5	1.2
TN 22ER070UN	T8030	–	■	160	■	95	■	150	■	480	■	40	–	–	7.0	2.5	1.8
TN 22ER060UN	T8030	–	■	160	■	95	■	150	■	480	■	40	–	–	6.0	2.5	1.8
TN 22ER050UN	T8030	–	■	160	■	95	■	150	■	480	■	40	–	–	5.0	2.5	1.8

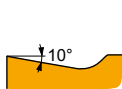

TN UN EL esterno sinistro, per operazioni di filettatura Unificata, taglio continuo.

TN 16EL320UN	T8030	–	■	160	■	95	■	150	■	480	■	40	–	–	32.0	0.8	0.8
TN 16EL280UN	T8030	–	■	160	■	95	■	150	■	480	■	40	–	–	28.0	0.8	0.8
TN 16EL240UN	T8030	–	■	160	■	95	■	150	■	480	■	40	–	–	24.0	0.8	0.8
TN 16EL200UN	T8030	–	■	160	■	95	■	150	■	480	■	40	–	–	20.0	0.8	0.8
TN 16EL180UN	T8030	–	■	160	■	95	■	150	■	480	■	40	–	–	18.0	0.8	0.8
TN 16EL160UN	T8030	–	■	160	■	95	■	150	■	480	■	40	–	–	16.0	0.8	0.8
TN 16EL140UN	T8030	–	■	160	■	95	■	150	■	480	■	40	–	–	14.0	1.5	1.2
TN 16EL120UN	T8030	–	■	160	■	95	■	150	■	480	■	40	–	–	12.0	1.5	1.2
TN 16EL110UN	T8030	–	■	160	■	95	■	150	■	480	■	40	–	–	11.0	1.5	1.2
TN 16EL100UN	T8030	–	■	160	■	95	■	150	■	480	■	40	–	–	10.0	1.5	1.2
TN 16EL090UN	T8030	–	■	160	■	95	■	150	■	480	■	40	–	–	9.0	1.5	1.2
TN 16EL080UN	T8030	–	■	160	■	95	■	150	■	480	■	40	–	–	8.0	1.5	1.2
TN 22EL070UN	T8030	–	■	160	■	95	■	150	■	480	■	40	–	–	7.0	2.5	1.8
TN 22EL060UN	T8030	–	■	160	■	95	■	150	■	480	■	40	–	–	6.0	2.5	1.8
TN 22EL050UN	T8030	–	■	160	■	95	■	150	■	480	■	40	–	–	5.0	2.5	1.8

Idoneità e valori iniziali per velocità di taglio (Vc). Fare riferimento alla nostra App Machining Calculator per ulteriori calcoli.

Codice prodotto	RE (mm)	P	M	K	N	S	H	TP	TPI	PDX	PDY

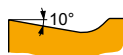

TN UN-P1 ER esterno destro, geometria stampata di precisione, per operazioni di filettatura Unificata, taglio continuo.

TN 16ER200UN-P1	T8030	-	■	160	■	95	■	150	▣	480	▣	40	-	-	20.0	0.8	0.8
TN 16ER180UN-P1	T8030	-	■	160	■	95	■	150	▣	480	▣	40	-	-	18.0	0.8	0.8
TN 16ER160UN-P1	T8030	-	■	160	■	95	■	150	▣	480	▣	40	-	-	16.0	0.8	0.8
TN 16ER140UN-P1	T8030	-	■	160	■	95	■	150	▣	480	▣	40	-	-	14.0	1.5	1.2
TN 16ER120UN-P1	T8030	-	■	160	■	95	■	150	▣	480	▣	40	-	-	12.0	1.5	1.2
TN 16ER080UN-P1	T8030	-	■	160	■	95	■	150	▣	480	▣	40	-	-	8.0	1.5	1.2

TN UN INT



	IC (mm)	L (mm)	S (mm)
16	9.525	16.50	3.47
22	12.700	22.00	4.71

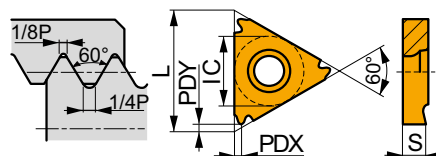

Idoneità e valori iniziali per velocità di taglio (Vc). Fare riferimento alla nostra App Machining Calculator per ulteriori calcoli.

Codice prodotto	RE (mm)	P	M	K	N	S	H	TP	TPI	PDX	PDY



TN UN NR interno destro, per operazioni di filettatura Unificata, taglio continuo.

TN 16NR320UN	T8030	-	■	160	■	95	■	150	▣	480	▣	40	-	-	32.0	0.8	0.8
TN 16NR280UN	T8030	-	■	160	■	95	■	150	▣	480	▣	40	-	-	28.0	0.8	0.8
TN 16NR240UN	T8030	-	■	160	■	95	■	150	▣	480	▣	40	-	-	24.0	0.8	0.8
TN 16NR200UN	T8010	-	■	175	▣	105	■	165	-	-	▣	40	-	-	20.0	0.8	0.8
	T8030	-	■	160	■	95	■	150	▣	480	▣	40	-	-	20.0	0.8	0.8
TN 16NR180UN	T8030	-	■	160	■	95	■	150	▣	480	▣	40	-	-	18.0	0.8	0.8
TN 16NR160UN	T8030	-	■	160	■	95	■	150	▣	480	▣	40	-	-	16.0	0.8	0.8
TN 16NR140UN	T8030	-	■	160	■	95	■	150	▣	480	▣	40	-	-	14.0	1.5	1.2
TN 16NR130UN	T8030	-	■	160	■	95	■	150	▣	480	▣	40	-	-	13.0	1.5	1.2
TN 16NR120UN	T8010	-	■	175	▣	105	■	165	-	-	▣	40	-	-	12.0	1.5	1.2
	T8030	-	■	160	■	95	■	150	▣	480	▣	40	-	-	12.0	1.5	1.2
TN 16NR115UN	T8030	-	■	160	■	95	■	150	▣	480	▣	40	-	-	11.5	1.5	1.2
TN 16NR110UN	T8030	-	■	160	■	95	■	150	▣	480	▣	40	-	-	11.0	1.5	1.2
TN 16NR100UN	T8030	-	■	160	■	95	■	150	▣	480	▣	40	-	-	10.0	1.5	1.2
TN 16NR080UN	T8010	-	■	175	▣	105	■	165	-	-	▣	40	-	-	8.0	1.5	1.2
	T8030	-	■	160	■	95	■	150	▣	480	▣	40	-	-	8.0	1.5	1.2
TN 22NR070UN	T8030	-	■	160	■	95	■	150	▣	480	▣	40	-	-	7.0	2.5	1.8
TN 22NR060UN	T8030	-	■	160	■	95	■	150	▣	480	▣	40	-	-	6.0	2.5	1.8
TN 22NR050UN	T8030	-	■	160	■	95	■	150	▣	480	▣	40	-	-	5.0	2.5	1.8

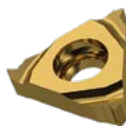

TN UN NL interno sinistro, per operazioni di filettatura Unificata, taglio continuo.

TN 16NL320UN	T8030	-	■	160	■	95	■	150	▣	480	▣	40	-	-	32.0	0.8	0.8
--------------	-------	---	---	-----	---	----	---	-----	---	-----	---	----	---	---	------	-----	-----

Idoneità e valori iniziali per velocità di taglio (Vc). Fare riferimento alla nostra App Machining Calculator per ulteriori calcoli.

Codice prodotto	RE (mm)	P	M	K	N	S	H	TP	TPI	PDX	PDY

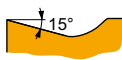
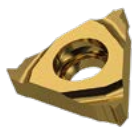

TN UN NL interno sinistro, per operazioni di filettatura Unificata, taglio continuo.

TN 16NL280UN	T8030	–	■	160	■	95	■	150	▣	480	▣	40	–	–	28.0	0.8	0.8
TN 16NL240UN	T8030	–	■	160	■	95	■	150	▣	480	▣	40	–	–	24.0	0.8	0.8
TN 16NL200UN	T8030	–	■	160	■	95	■	150	▣	480	▣	40	–	–	20.0	0.8	0.8
TN 16NL180UN	T8030	–	■	160	■	95	■	150	▣	480	▣	40	–	–	18.0	0.8	0.8
TN 16NL160UN	T8030	–	■	160	■	95	■	150	▣	480	▣	40	–	–	16.0	0.8	0.8
TN 16NL140UN	T8030	–	■	160	■	95	■	150	▣	480	▣	40	–	–	14.0	1.5	1.2
TN 16NL120UN	T8030	–	■	160	■	95	■	150	▣	480	▣	40	–	–	12.0	1.5	1.2
TN 16NL110UN	T8030	–	■	160	■	95	■	150	▣	480	▣	40	–	–	11.0	1.5	1.2
TN 16NL100UN	T8030	–	■	160	■	95	■	150	▣	480	▣	40	–	–	10.0	1.5	1.2
TN 16NL080UN	T8030	–	■	160	■	95	■	150	▣	480	▣	40	–	–	8.0	1.5	1.2
TN 22NL070UN	T8030	–	■	160	■	95	■	150	▣	480	▣	40	–	–	7.0	2.5	1.8
TN 22NL060UN	T8030	–	■	160	■	95	■	150	▣	480	▣	40	–	–	6.0	2.5	1.8

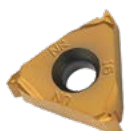

TN UN-P1 NR interno destro, geometria stampata di precisione, per operazioni di filettatura Unificata, taglio continuo.

TN 16NR200UN-P1	T8030	–	■	160	■	95	■	150	▣	480	▣	40	–	–	20.0	0.8	0.8
TN 16NR180UN-P1	T8030	–	■	160	■	95	■	150	▣	480	▣	40	–	–	18.0	0.8	0.8
TN 16NR160UN-P1	T8030	–	■	160	■	95	■	150	▣	480	▣	40	–	–	16.0	0.8	0.8
TN 16NR140UN-P1	T8030	–	■	160	■	95	■	150	▣	480	▣	40	–	–	14.0	1.5	1.2
TN 16NR120UN-P1	T8030	–	■	160	■	95	■	150	▣	480	▣	40	–	–	12.0	1.5	1.2
TN 16NR080UN-P1	T8030	–	■	160	■	95	■	150	▣	480	▣	40	–	–	8.0	1.5	1.2

NEW

TN UNJ EXT

PRAMET

	IC (mm)	L (mm)	S (mm)
16	9.525	16.50	3.47

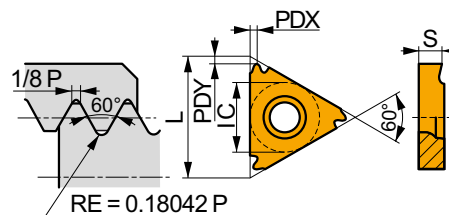

Idoneità e valori iniziali per velocità di taglio (Vc). Fare riferimento alla nostra App Machining Calculator per ulteriori calcoli.

Codice prodotto	RE (mm)	P	M	K	N	S	H	TP	TPI	PDX	PDY

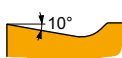

TN UNJ ER esterno destro, per operazioni di filettatura Unificata "forma J", taglio continuo.

TN 16ER320UNJ	T8030	–	■	160	■	95	■	150	▣	480	▣	40	–	–	32.0	0.8	0.8
TN 16ER280UNJ	T8030	–	■	160	■	95	■	150	▣	480	▣	40	–	–	28.0	0.8	0.8
TN 16ER240UNJ	T8030	–	■	160	■	95	■	150	▣	480	▣	40	–	–	24.0	0.8	0.8
TN 16ER200UNJ	T8030	–	■	160	■	95	■	150	▣	480	▣	40	–	–	20.0	0.8	0.8
TN 16ER180UNJ	T8030	–	■	160	■	95	■	150	▣	480	▣	40	–	–	18.0	0.8	0.8
TN 16ER160UNJ	T8030	–	■	160	■	95	■	150	▣	480	▣	40	–	–	16.0	1.5	1.2
TN 16ER120UNJ	T8030	–	■	160	■	95	■	150	▣	480	▣	40	–	–	12.0	1.5	1.2

Idoneità e valori iniziali per velocità di taglio (Vc). Fare riferimento alla nostra App Machining Calculator per ulteriori calcoli.

Codice prodotto	RE (mm)	P	M	K	N	S	H	TP	TPI	PDX	PDY

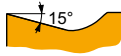

TN UNJ EL esterno sinistro, per operazioni di filettatura Unificata "forma J", taglio continuo.

TN 16EL320UNJ	T8030	-	■	160	■	95	■	150	▣	480	▣	40	-	-	32.0	0.8	0.8
TN 16EL280UNJ	T8030	-	■	160	■	95	■	150	▣	480	▣	40	-	-	28.0	0.8	0.8
TN 16EL240UNJ	T8030	-	■	160	■	95	■	150	▣	480	▣	40	-	-	24.0	0.8	0.8
TN 16EL200UNJ	T8030	-	■	160	■	95	■	150	▣	480	▣	40	-	-	20.0	0.8	0.8
TN 16EL180UNJ	T8030	-	■	160	■	95	■	150	▣	480	▣	40	-	-	18.0	0.8	0.8
TN 16EL160UNJ	T8030	-	■	160	■	95	■	150	▣	480	▣	40	-	-	16.0	1.5	1.2
TN 16EL120UNJ	T8030	-	■	160	■	95	■	150	▣	480	▣	40	-	-	12.0	1.5	1.2

TN W EXT



	IC (mm)	L (mm)	S (mm)
16	9.525	16.50	3.47
22	12.700	22.00	4.71

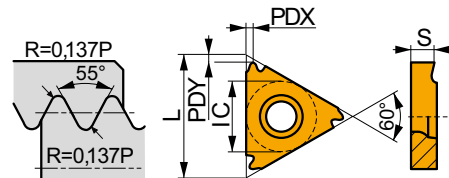

Idoneità e valori iniziali per velocità di taglio (Vc). Fare riferimento alla nostra App Machining Calculator per ulteriori calcoli.

Codice prodotto	RE (mm)	P	M	K	N	S	H	TP	TPI	PDX	PDY

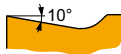

TN W ER esterno destro, per operazioni di filettatura Whitworth, taglio continuo.

TN 16ER280W	T8030	-	■	160	■	95	■	150	▣	480	▣	40	-	-	28.0	0.8	0.8
TN 16ER260W	T8030	-	■	160	■	95	■	150	▣	480	▣	40	-	-	26.0	0.8	0.8
TN 16ER240W	T8030	-	■	160	■	95	■	150	▣	480	▣	40	-	-	24.0	0.8	0.8
TN 16ER200W	T8030	-	■	160	■	95	■	150	▣	480	▣	40	-	-	20.0	0.8	0.8
TN 16ER190W	T8010	-	■	175	▣	105	■	165	▣	-	▣	40	-	-	19.0	0.8	0.8
	T8030	-	■	160	■	95	■	150	▣	480	▣	40	-	-	19.0	0.8	0.8
TN 16ER180W	T8030	-	■	160	■	95	■	150	▣	480	▣	40	-	-	18.0	0.8	0.8
TN 16ER160W	T8030	-	■	160	■	95	■	150	▣	480	▣	40	-	-	16.0	0.8	0.8
TN 16ER140W	T8010	-	■	175	▣	105	■	165	▣	-	▣	40	-	-	14.0	1.5	1.2
	T8030	-	■	160	■	95	■	150	▣	480	▣	40	-	-	14.0	1.5	1.2
TN 16ER120W	T8030	-	■	160	■	95	■	150	▣	480	▣	40	-	-	12.0	1.5	1.2
TN 16ER110W	T8010	-	■	175	▣	105	■	165	▣	-	▣	40	-	-	11.0	1.5	1.2
	T8030	-	■	160	■	95	■	150	▣	480	▣	40	-	-	11.0	1.5	1.2
TN 16ER100W	T8030	-	■	160	■	95	■	150	▣	480	▣	40	-	-	10.0	1.5	1.2
TN 16ER090W	T8030	-	■	160	■	95	■	150	▣	480	▣	40	-	-	9.0	1.5	1.2
TN 16ER080W	T8030	-	■	160	■	95	■	150	▣	480	▣	40	-	-	8.0	1.5	1.2
TN 22ER070W	T8030	-	■	160	■	95	■	150	▣	480	▣	40	-	-	7.0	2.5	1.8
TN 22ER060W	T8030	-	■	160	■	95	■	150	▣	480	▣	40	-	-	6.0	2.5	1.8
TN 22ER050W	T8030	-	■	160	■	95	■	150	▣	480	▣	40	-	-	5.0	2.5	1.7

Idoneità e valori iniziali per velocità di taglio (Vc). Fare riferimento alla nostra App Machining Calculator per ulteriori calcoli.

Codice prodotto	RE (mm)	P	M	K	N	S	H	TP	TPI	PDX	PDY

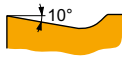
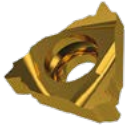

TN W EL esterno sinistro, per operazioni di filettatura Whitworth, taglio continuo.

TN 16EL280W	T8030	–	■	160	■	95	■	150	■	480	■	40	–	–	28.0	0.8	0.8
TN 16EL260W	T8030	–	■	160	■	95	■	150	■	480	■	40	–	–	26.0	0.8	0.8
TN 16EL240W	T8030	–	■	160	■	95	■	150	■	480	■	40	–	–	24.0	0.8	0.8
TN 16EL200W	T8030	–	■	160	■	95	■	150	■	480	■	40	–	–	20.0	0.8	0.8
TN 16EL190W	T8030	–	■	160	■	95	■	150	■	480	■	40	–	–	19.0	0.8	0.8
TN 16EL160W	T8030	–	■	160	■	95	■	150	■	480	■	40	–	–	16.0	0.8	0.8
TN 16EL140W	T8030	–	■	160	■	95	■	150	■	480	■	40	–	–	14.0	1.5	1.2
TN 16EL120W	T8030	–	■	160	■	95	■	150	■	480	■	40	–	–	12.0	1.5	1.2
TN 16EL110W	T8030	–	■	160	■	95	■	150	■	480	■	40	–	–	11.0	1.5	1.2
TN 16EL100W	T8030	–	■	160	■	95	■	150	■	480	■	40	–	–	10.0	1.5	1.2
TN 16EL090W	T8030	–	■	160	■	95	■	150	■	480	■	40	–	–	9.0	1.5	1.2
TN 16EL080W	T8030	–	■	160	■	95	■	150	■	480	■	40	–	–	8.0	1.5	1.2
TN 22EL070W	T8030	–	■	160	■	95	■	150	■	480	■	40	–	–	7.0	2.5	1.8
TN 22EL060W	T8030	–	■	160	■	95	■	150	■	480	■	40	–	–	6.0	2.5	1.8
TN 22EL050W	T8030	–	■	160	■	95	■	150	■	480	■	40	–	–	5.0	2.5	1.7

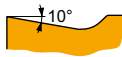

TN W-P1 ER esterno destro, geometria stampata di precisione, per operazioni di filettatura Whitworth, taglio continuo.

TN 16ER190W-P1	T8030	–	■	160	■	95	■	150	■	480	■	40	–	–	19.0	0.8	0.8
TN 16ER140W-P1	T8030	–	■	160	■	95	■	150	■	480	■	40	–	–	14.0	1.5	1.2
TN 16ER110W-P1	T8030	–	■	160	■	95	■	150	■	480	■	40	–	–	11.0	1.5	1.2

TN W INT

PRAMET

	IC (mm)	L (mm)	S (mm)
11	6.350	11.00	3.00
16	9.525	16.50	3.47
22	12.700	22.00	4.71

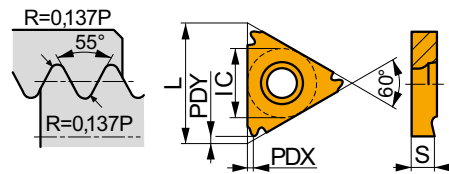

Idoneità e valori iniziali per velocità di taglio (Vc). Fare riferimento alla nostra App Machining Calculator per ulteriori calcoli.

Codice prodotto	RE (mm)	P	M	K	N	S	H	TP	TPI	PDX	PDY

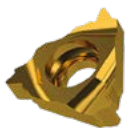

TN W NR interno destro, per operazioni di filettatura Whitworth, taglio continuo.

TN 11NR190W	T8010	–	■	175	■	105	■	165	–	–	■	40	–	–	19.0	0.8	0.8
	T8030	–	■	160	■	95	■	150	■	480	■	40	–	–	19.0	0.8	0.8
TN 11NR140W	T8010	–	■	175	■	105	■	165	–	–	■	40	–	–	14.0	0.9	0.7
	T8030	–	■	160	■	95	■	150	■	480	■	40	–	–	14.0	0.9	0.7
TN 16NR280W	T8030	–	■	160	■	95	■	150	■	480	■	40	–	–	28.0	0.8	0.8
TN 16NR260W	T8030	–	■	160	■	95	■	150	■	480	■	40	–	–	26.0	0.8	0.8
TN 16NR240W	T8030	–	■	160	■	95	■	150	■	480	■	40	–	–	24.0	0.8	0.8
TN 16NR200W	T8030	–	■	160	■	95	■	150	■	480	■	40	–	–	20.0	0.8	0.8

Idoneità e valori iniziali per velocità di taglio (Vc). Fare riferimento alla nostra App Machining Calculator per ulteriori calcoli.

Codice prodotto	RE (mm)	P	M	K	N	S	H	TP	TPI	PDX	PDY	vc	
												(m/min)	(m/min)

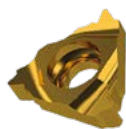

TN W NR interno destro, per operazioni di filettatura Whitworth, taglio continuo.

TN 16NR190W	T8010	–	■	175	☑	105	■	165	–	☑	40	–	–	19.0	0.8	0.8	
	T8030	–	■	160	■	95	■	150	☑	480	☑	40	–	–	19.0	0.8	0.8
TN 16NR160W	T8030	–	■	160	■	95	■	150	☑	480	☑	40	–	–	16.0	0.8	0.8
TN 16NR140W	T8010	–	■	175	☑	105	■	165	–	☑	40	–	–	14.0	1.5	1.2	
	T8030	–	■	160	■	95	■	150	☑	480	☑	40	–	–	14.0	1.5	1.2
TN 16NR120W	T8030	–	■	160	■	95	■	150	☑	480	☑	40	–	–	12.0	1.5	1.2
TN 16NR110W	T8010	–	■	175	☑	105	■	165	–	☑	40	–	–	11.0	1.5	1.2	
	T8030	–	■	160	■	95	■	150	☑	480	☑	40	–	–	11.0	1.5	1.2
TN 16NR100W	T8030	–	■	160	■	95	■	150	☑	480	☑	40	–	–	10.0	1.5	1.2
TN 16NR090W	T8030	–	■	160	■	95	■	150	☑	480	☑	40	–	–	9.0	1.5	1.2
TN 16NR080W	T8030	–	■	160	■	95	■	150	☑	480	☑	40	–	–	8.0	1.5	1.2
TN 22NR070W	T8030	–	■	160	■	95	■	150	☑	480	☑	40	–	–	7.0	2.5	1.8
TN 22NR060W	T8030	–	■	160	■	95	■	150	☑	480	☑	40	–	–	6.0	2.5	1.8
TN 22NR050W	T8030	–	■	160	■	95	■	150	☑	480	☑	40	–	–	5.0	2.5	1.7



TN W NL interno sinistro, per operazioni di filettatura Whitworth, taglio continuo.

TN 11NL190W	T8030	–	■	160	■	95	■	150	☑	480	☑	40	–	–	19.0	0.8	0.8
TN 11NL140W	T8030	–	■	160	■	95	■	150	☑	480	☑	40	–	–	14.0	0.9	0.7
TN 16NL280W	T8030	–	■	160	■	95	■	150	☑	480	☑	40	–	–	28.0	0.8	0.8
TN 16NL260W	T8030	–	■	160	■	95	■	150	☑	480	☑	40	–	–	26.0	0.8	0.8
TN 16NL240W	T8030	–	■	160	■	95	■	150	☑	480	☑	40	–	–	24.0	0.8	0.8
TN 16NL200W	T8030	–	■	160	■	95	■	150	☑	480	☑	40	–	–	20.0	0.8	0.8
TN 16NL190W	T8030	–	■	160	■	95	■	150	☑	480	☑	40	–	–	19.0	0.8	0.8
TN 16NL160W	T8030	–	■	160	■	95	■	150	☑	480	☑	40	–	–	16.0	0.8	0.8
TN 16NL140W	T8030	–	■	160	■	95	■	150	☑	480	☑	40	–	–	14.0	1.5	1.2
TN 16NL120W	T8030	–	■	160	■	95	■	150	☑	480	☑	40	–	–	12.0	1.5	1.2
TN 16NL110W	T8030	–	■	160	■	95	■	150	☑	480	☑	40	–	–	11.0	1.5	1.2
TN 16NL100W	T8030	–	■	160	■	95	■	150	☑	480	☑	40	–	–	10.0	1.5	1.2
TN 16NL090W	T8030	–	■	160	■	95	■	150	☑	480	☑	40	–	–	9.0	1.5	1.2
TN 16NL080W	T8030	–	■	160	■	95	■	150	☑	480	☑	40	–	–	8.0	1.5	1.2
TN 22NL070W	T8030	–	■	160	■	95	■	150	☑	480	☑	40	–	–	7.0	2.5	1.8
TN 22NL060W	T8030	–	■	160	■	95	■	150	☑	480	☑	40	–	–	6.0	2.5	1.8
TN 22NL050W	T8030	–	■	160	■	95	■	150	☑	480	☑	40	–	–	5.0	2.5	1.7



TN W-P1 NR interno destro, geometria stampata di precisione, per operazioni di filettatura Whitworth, taglio continuo.

TN 11NR190W-P1	T8030	–	■	160	■	95	■	150	☑	480	☑	40	–	–	19.0	0.8	0.8
TN 11NR140W-P1	T8030	–	■	160	■	95	■	150	☑	480	☑	40	–	–	14.0	0.9	0.7
TN 16NR140W-P1	T8030	–	■	160	■	95	■	150	☑	480	☑	40	–	–	14.0	1.5	1.2
TN 16NR110W-P1	T8030	–	■	160	■	95	■	150	☑	480	☑	40	–	–	11.0	1.5	1.2

TN 55° PP EXT

	IC (mm)	L (mm)	S (mm)
16	9.525	16.50	3.47
22	12.700	22.00	4.71

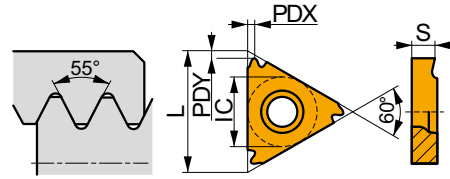

Idoneità e valori iniziali per velocità di taglio (Vc). Fare riferimento alla nostra App Machining Calculator per ulteriori calcoli.

Codice prodotto	RE (mm)	P	M	K	N	S	H	TPN (mm)	TPX (mm)	TPIN	TPIX	PDX (mm)	PDY (mm)
		vc (m/min)	vc (m/min)	vc (m/min)	vc (m/min)	vc (m/min)	vc (m/min)						

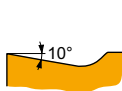

TN 55° PP ER esterno destro, per operazioni di filettatura Whitworth, taglio continuo.

TN 16ERA55	T8030	–	■ 160	■ 95	■ 150	▣ 480	▣ 40	–	0.50	1.50	16	48	0.8	0.6
TN 16ERAG55	T8010	–	■ 175	▣ 105	■ 165	–	▣ 40	–	0.50	3.00	8	48	1.5	1.1
	T8030	–	■ 160	■ 95	■ 150	▣ 480	▣ 40	–	0.50	3.00	8	48	1.5	1.1
TN 16ERG55	T8030	–	■ 160	■ 95	■ 150	▣ 480	▣ 40	–	1.75	3.00	8	14	1.5	1.1
TN 22ERN55	T8010	–	■ 175	▣ 105	■ 165	–	▣ 40	–	3.50	5.00	5	7	2.5	1.8
	T8030	–	■ 160	■ 95	■ 150	▣ 480	▣ 40	–	3.50	5.00	5	7	2.5	1.8

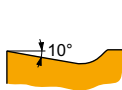

TN 55° PP EL esterno sinistro, per operazioni di filettatura Whitworth, taglio continuo.

TN 16ELA55	T8030	–	■ 160	■ 95	■ 150	▣ 480	▣ 40	–	0.50	1.50	16	48	0.8	0.6
TN 16ELAG55	T8030	–	■ 160	■ 95	■ 150	▣ 480	▣ 40	–	0.50	3.00	8	48	1.5	1.1
TN 16ELG55	T8030	–	■ 160	■ 95	■ 150	▣ 480	▣ 40	–	1.75	3.00	8	14	1.5	1.1
TN 22ELN55	T8030	–	■ 160	■ 95	■ 150	▣ 480	▣ 40	–	3.50	5.00	5	7	2.5	1.8

TN 55° PP INT

	IC (mm)	L (mm)	S (mm)
11	6.350	11.00	3.00
16	9.525	16.50	3.47
22	12.700	22.00	4.71

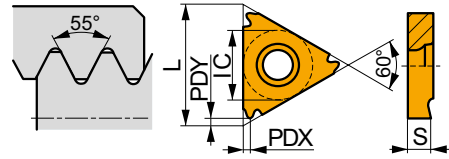

Idoneità e valori iniziali per velocità di taglio (Vc). Fare riferimento alla nostra App Machining Calculator per ulteriori calcoli.

Codice prodotto	RE (mm)	P	M	K	N	S	H	TPN (mm)	TPX (mm)	TPIN	TPIX	PDX (mm)	PDY (mm)
		vc (m/min)	vc (m/min)	vc (m/min)	vc (m/min)	vc (m/min)	vc (m/min)						

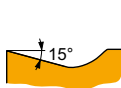
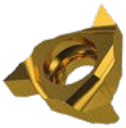

TN W55 PP NR interno destro, per operazioni di filettatura Whitworth, taglio continuo.

TN 11NRA55	T8030	–	■	160	■	95	■	150	☑	480	☑	40	–	0.50	1.50	16	48	0.8	0.6
TN 16NRA55	T8030	–	■	160	■	95	■	150	☑	480	☑	40	–	0.50	1.50	16	48	0.8	0.6
TN 16NRAG55	T8010	–	■	175	☑	105	■	165	–	–	☑	40	–	0.50	3.00	8	48	1.5	1.1
	T8030	–	■	160	■	95	■	150	☑	480	☑	40	–	0.50	3.00	8	48	1.5	1.1
TN 16NRG55	T8030	–	■	160	■	95	■	150	☑	480	☑	40	–	1.75	3.00	8	14	1.5	1.1
TN 22NRN55	T8030	–	■	160	■	95	■	150	☑	480	☑	40	–	3.50	5.00	5	7	2.5	1.8

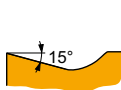

TN W55 PP NL interno sinistro, per operazioni di filettatura Whitworth, taglio continuo.

TN 11NLA55	T8030	–	■	160	■	95	■	150	☑	480	☑	40	–	0.50	1.50	16	48	0.8	0.6
TN 16NLA55	T8030	–	■	160	■	95	■	150	☑	480	☑	40	–	0.50	1.50	16	48	0.8	0.6
TN 16NLAG55	T8030	–	■	160	■	95	■	150	☑	480	☑	40	–	0.50	3.00	8	48	1.5	1.1
TN 16NLG55	T8030	–	■	160	■	95	■	150	☑	480	☑	40	–	1.75	3.00	8	14	1.5	1.1
TN 22NLN55	T8030	–	■	160	■	95	■	150	☑	480	☑	40	–	3.50	5.00	5	7	2.5	1.8

TN BSPT EXT

	IC (mm)	L (mm)	S (mm)
16	9.525	16.50	3.47

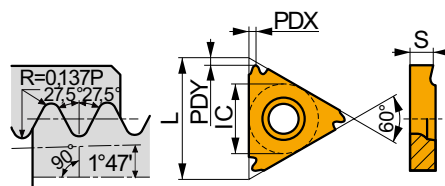

Idoneità e valori iniziali per velocità di taglio (Vc). Fare riferimento alla nostra App Machining Calculator per ulteriori calcoli.

Codice prodotto	RE (mm)	P	M	K	N	S	H	TP (mm)	TPI	PDX (mm)	PDY (mm)
		vc (m/min)	vc (m/min)	vc (m/min)	vc (m/min)	vc (m/min)	vc (m/min)				



TN BSPT ER esterno destro, per operazioni di filettatura BSPT, taglio continuo.

TN 16ER280BSPT	T8030	–	160	95	150	480	40	–	–	28.0	0.8	0.8
TN 16ER190BSPT	T8030	–	160	95	150	480	40	–	–	19.0	1.5	1.2
TN 16ER140BSPT	T8030	–	160	95	150	480	40	–	–	14.0	1.5	1.2
TN 16ER110BSPT	T8030	–	160	95	150	480	40	–	–	11.0	1.5	1.2

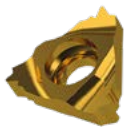

TN BSPT EL esterno sinistro, per operazioni di filettatura BSPT, taglio continuo.

TN 16EL280BSPT	T8030	–	160	95	150	480	40	–	–	28.0	0.8	0.8
TN 16EL190BSPT	T8030	–	160	95	150	480	40	–	–	19.0	1.5	1.2
TN 16EL140BSPT	T8030	–	160	95	150	480	40	–	–	14.0	1.5	1.2
TN 16EL110BSPT	T8030	–	160	95	150	480	40	–	–	11.0	1.5	1.2

TN BSPT INT

	IC (mm)	L (mm)	S (mm)
16	9.525	16.50	3.47

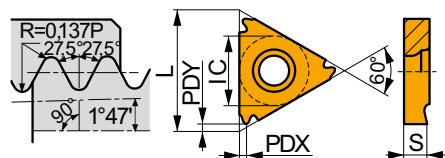

Idoneità e valori iniziali per velocità di taglio (Vc). Fare riferimento alla nostra App Machining Calculator per ulteriori calcoli.

Codice prodotto	RE (mm)	P	M	K	N	S	H	TP (mm)	TPI	PDX (mm)	PDY (mm)
		vc (m/min)	vc (m/min)	vc (m/min)	vc (m/min)	vc (m/min)	vc (m/min)				

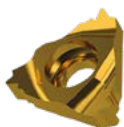

TN BSPT NR interno destro, per operazioni di filettatura BSPT, taglio continuo.

TN 16NR280BSPT	T8030	–	160	95	150	480	40	–	–	28.0	0.8	0.8
TN 16NR190BSPT	T8030	–	160	95	150	480	40	–	–	19.0	1.5	1.2

Idoneità e valori iniziali per velocità di taglio (Vc). Fare riferimento alla nostra App Machining Calculator per ulteriori calcoli.

Codice prodotto	RE (mm)	P	M	K	N	S	H	TP	TPI	PDX	PDY

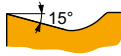
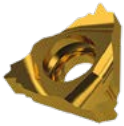

TN BSPT NR interno destro, per operazioni di filettatura BSPT, taglio continuo.

TN 16NR140BSPT	T8030	–	■	160	■	95	■	150	☑	480	☑	40	–	–	14.0	1.5	1.2
TN 16NR110BSPT	T8030	–	■	160	■	95	■	150	☑	480	☑	40	–	–	11.0	1.5	1.2

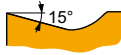

TN BSPT NL interno sinistro, per operazioni di filettatura BSPT, taglio continuo.

TN 16NL280BSPT	T8030	–	■	160	■	95	■	150	☑	480	☑	40	–	–	28.0	0.8	0.8
TN 16NL190BSPT	T8030	–	■	160	■	95	■	150	☑	480	☑	40	–	–	19.0	1.5	1.2
TN 16NL140BSPT	T8030	–	■	160	■	95	■	150	☑	480	☑	40	–	–	14.0	1.5	1.2
TN 16NL110BSPT	T8030	–	■	160	■	95	■	150	☑	480	☑	40	–	–	11.0	1.5	1.2

TN NPT EXT



	IC (mm)	L (mm)	S (mm)
16	9.525	16.50	3.47

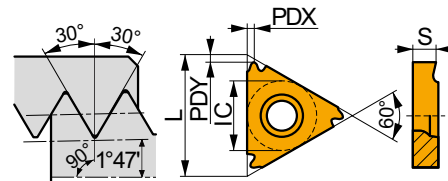

Idoneità e valori iniziali per velocità di taglio (Vc). Fare riferimento alla nostra App Machining Calculator per ulteriori calcoli.

Codice prodotto	RE (mm)	P	M	K	N	S	H	TP	TPI	PDX	PDY



TN NPT ER esterno destro, per operazioni di filettatura NPT, taglio continuo.

TN 16ER270NPT	T8030	–	■	160	■	95	■	150	☑	480	☑	40	–	–	27.0	0.8	0.7
TN 16ER180NPT	T8030	–	■	160	■	95	■	150	☑	480	☑	40	–	–	18.0	0.8	0.7
TN 16ER140NPT	T8010	–	■	175	☑	105	■	165	–	–	☑	40	–	–	14.0	1.5	1.1
	T8030	–	■	160	■	95	■	150	☑	480	☑	40	–	–	14.0	1.5	1.1
TN 16ER115NPT	T8010	–	■	175	☑	105	■	165	–	–	☑	40	–	–	11.5	1.5	1.1
	T8030	–	■	160	■	95	■	150	☑	480	☑	40	–	–	11.5	1.5	1.1
TN 16ER080NPT	T8030	–	■	160	■	95	■	150	☑	480	☑	40	–	–	8.0	1.6	1.1

TN NPT INT

PRAMET

	IC (mm)	L (mm)	S (mm)
11	6.350	11.00	3.00
16	9.525	16.50	3.47

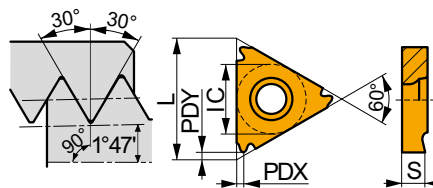

Idoneità e valori iniziali per velocità di taglio (Vc). Fare riferimento alla nostra App Machining Calculator per ulteriori calcoli.

Codice prodotto	RE (mm)	P	M	K	N	S	H	TP (mm)	TPI	PDX (mm)	PDY (mm)
		vc (m/min)	vc (m/min)	vc (m/min)	vc (m/min)	vc (m/min)	vc (m/min)				

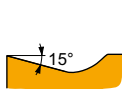
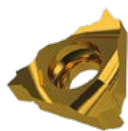

TN NPT NR interno destro, per operazioni di filettatura NPT, taglio continuo.

TN 11NR180NPT	T8030	–	■	160	■	95	■	150	■	480	■	40	–	–	18.0	0.8	0.7
TN 11NR140NPT	T8030	–	■	160	■	95	■	150	■	480	■	40	–	–	14.0	1.0	0.7
TN 16NR140NPT	T8010	–	■	175	■	105	■	165	■	–	■	40	–	–	14.0	1.5	1.1
	T8030	–	■	160	■	95	■	150	■	480	■	40	–	–	14.0	1.5	1.1
TN 16NR115NPT	T8010	–	■	175	■	105	■	165	■	–	■	40	–	–	11.5	1.5	1.1
	T8030	–	■	160	■	95	■	150	■	480	■	40	–	–	11.5	1.5	1.1
TN 16NR080NPT	T8030	–	■	160	■	95	■	150	■	480	■	40	–	–	8.0	1.6	1.1

TN TR EXT

PRAMET

	IC (mm)	L (mm)	S (mm)
16	9.525	16.50	3.47
22	12.700	22.00	4.71

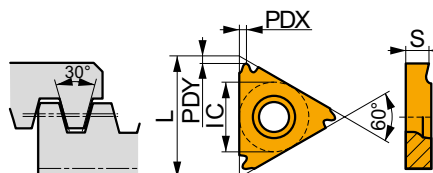

Idoneità e valori iniziali per velocità di taglio (Vc). Fare riferimento alla nostra App Machining Calculator per ulteriori calcoli.

Codice prodotto	RE (mm)	P	M	K	N	S	H	TP (mm)	TPI	PDX (mm)	PDY (mm)
		vc (m/min)	vc (m/min)	vc (m/min)	vc (m/min)	vc (m/min)	vc (m/min)				

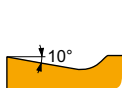

TN TR ER esterno destro, per operazioni di filettatura Trapezoidale, taglio continuo.

TN 16ER150TR	T8030	–	■	160	■	95	■	150	■	480	■	40	–	1.50	–	0.8	0.9
TN 16ER200TR	T8030	–	■	160	■	95	■	150	■	480	■	40	–	2.00	–	1.5	1.3
TN 16ER300TR	T8030	–	■	160	■	95	■	150	■	480	■	40	–	3.00	–	1.6	1.3
TN 22ER400TR	T8030	–	■	160	■	95	■	150	■	480	■	40	–	4.00	–	2.2	1.8
TN 22ER500TR	T8030	–	■	160	■	95	■	150	■	480	■	40	–	5.00	–	2.2	1.8

Idoneità e valori iniziali per velocità di taglio (Vc). Fare riferimento alla nostra App Machining Calculator per ulteriori calcoli.

Codice prodotto	RE (mm)	P	M	K	N	S	H	TP	TPI	PDX	PDY

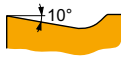

TN TR EL esterno sinistro, per operazioni di filettatura Trapezoidale, taglio continuo.

TN 16EL150TR	T8030	-	■	160	■	95	■	150	☑	480	☑	40	-	1.50	-	0.8	0.9
TN 16EL200TR	T8030	-	■	160	■	95	■	150	☑	480	☑	40	-	2.00	-	1.5	1.3
TN 16EL300TR	T8030	-	■	160	■	95	■	150	☑	480	☑	40	-	3.00	-	1.6	1.3
TN 22EL400TR	T8030	-	■	160	■	95	■	150	☑	480	☑	40	-	4.00	-	2.2	1.8
TN 22EL500TR	T8030	-	■	160	■	95	■	150	☑	480	☑	40	-	5.00	-	2.2	1.8

TN TR INT



	IC (mm)	L (mm)	S (mm)
16	9.525	16.50	3.47
22	12.700	22.00	4.71

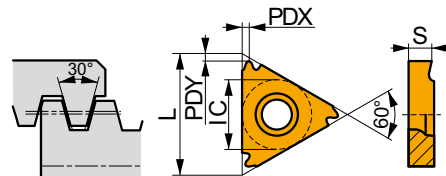

Idoneità e valori iniziali per velocità di taglio (Vc). Fare riferimento alla nostra App Machining Calculator per ulteriori calcoli.

Codice prodotto	RE (mm)	P	M	K	N	S	H	TP	TPI	PDX	PDY



TN TR NR interno destro, per operazioni di filettatura Trapezoidale, taglio continuo.

TN 16NR150TR	T8030	-	■	160	■	95	■	150	☑	480	☑	40	-	1.50	-	0.8	0.9
TN 16NR200TR	T8030	-	■	160	■	95	■	150	☑	480	☑	40	-	2.00	-	1.5	1.3
TN 16NR300TR	T8030	-	■	160	■	95	■	150	☑	480	☑	40	-	3.00	-	1.6	1.3
TN 22NR400TR	T8030	-	■	160	■	95	■	150	☑	480	☑	40	-	4.00	-	2.2	1.8
TN 22NR500TR	T8030	-	■	160	■	95	■	150	☑	480	☑	40	-	5.00	-	2.2	1.8

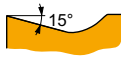

TN TR NL interno sinistro, per operazioni di filettatura Trapezoidale, taglio continuo.

TN 16NL150TR	T8030	-	■	160	■	95	■	150	☑	480	☑	40	-	1.50	-	0.8	0.9
TN 16NL200TR	T8030	-	■	160	■	95	■	150	☑	480	☑	40	-	2.00	-	1.5	1.3
TN 16NL300TR	T8030	-	■	160	■	95	■	150	☑	480	☑	40	-	3.00	-	1.6	1.3
TN 22NL400TR	T8030	-	■	160	■	95	■	150	☑	480	☑	40	-	4.00	-	2.2	1.8
TN 22NL500TR	T8030	-	■	160	■	95	■	150	☑	480	☑	40	-	5.00	-	2.2	1.8

TN TR-S EXT

PRAMET

	IC (mm)	L (mm)	S (mm)
22	12.700	22.00	4.60

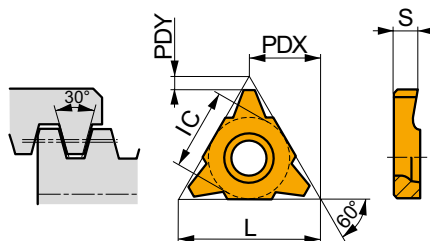

Idoneità e valori iniziali per velocità di taglio (Vc). Fare riferimento alla nostra App Machining Calculator per ulteriori calcoli.

Codice prodotto	RE (mm)	P	M	K	N	S	H	TP (mm)	TPI	PDX (mm)	PDY (mm)
		vc (m/min)	vc (m/min)	vc (m/min)	vc (m/min)	vc (m/min)	vc (m/min)				

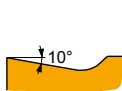

TN TR-S PP EN esterno con design neutro (destra e sinistra), per operazioni di filettatura Trapezoidale, taglio continuo.

TN 22EN600TR	T8030	-	160	95	150	480	40	6.00	-	11.0	1.9
TN 22EN700TR	T8030	-	160	95	150	480	40	7.00	-	11.0	2.3

TN TR-S INT

PRAMET

	IC (mm)	L (mm)	S (mm)
22	12.700	22.00	4.60

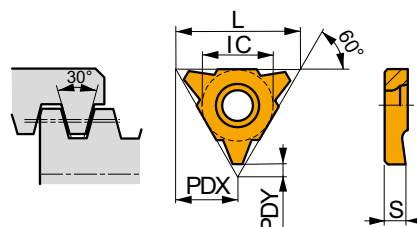

Idoneità e valori iniziali per velocità di taglio (Vc). Fare riferimento alla nostra App Machining Calculator per ulteriori calcoli.

Codice prodotto	RE (mm)	P	M	K	N	S	H	TP (mm)	TPI	PDX (mm)	PDY (mm)
		vc (m/min)	vc (m/min)	vc (m/min)	vc (m/min)	vc (m/min)	vc (m/min)				

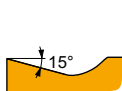

TN M60-S PP NN interno con design neutro (destra e sinistra), per operazioni di filettatura Metrica e Unificata, taglio continuo.

TN 22NN600TR	T8030	-	160	95	150	480	40	6.00	-	11.0	1.9
TN 22NN700TR	T8030	-	160	95	150	480	40	7.00	-	11.0	2.3

TN ACME EXT

	IC (mm)	L (mm)	S (mm)
16	9.525	16.50	3.47
22	12.700	22.00	4.71

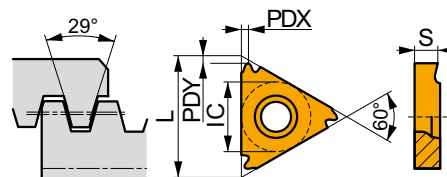

Idoneità e valori iniziali per velocità di taglio (Vc). Fare riferimento alla nostra App Machining Calculator per ulteriori calcoli.

Codice prodotto	RE (mm)	P vc (m/min)	M vc (m/min)	K vc (m/min)	N vc (m/min)	S vc (m/min)	H vc (m/min)	TP (mm)	TPI	PDX (mm)	PDY (mm)

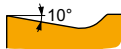

TN ACME ER esterno destro, per operazioni di filettatura ACME, taglio continuo.

TN 16ER120ACME	T8030	–	160	95	150	480	40	–	–	12.0	1.5	1.3
TN 16ER100ACME	T8030	–	160	95	150	480	40	–	–	10.0	1.5	1.3
TN 16ER080ACME	T8030	–	160	95	150	480	40	–	–	8.0	1.5	1.3
TN 22ER060ACME	T8030	–	160	95	150	480	40	–	–	6.0	2.5	2.0
TN 22ER050ACME	T8030	–	160	95	150	480	40	–	–	5.0	2.3	2.0



TN ACME EL esterno sinistro, per operazioni di filettatura ACME, taglio continuo.

TN 16EL120ACME	T8030	–	160	95	150	480	40	–	–	12.0	1.5	1.3
TN 16EL100ACME	T8030	–	160	95	150	480	40	–	–	10.0	1.5	1.3
TN 16EL080ACME	T8030	–	160	95	150	480	40	–	–	8.0	1.5	1.3
TN 22EL060ACME	T8030	–	160	95	150	480	40	–	–	6.0	2.5	2.0
TN 22EL050ACME	T8030	–	160	95	150	480	40	–	–	5.0	2.3	2.0

TN ACME INT

	IC (mm)	L (mm)	S (mm)
16	9.525	16.50	3.47
22	12.700	22.00	4.71

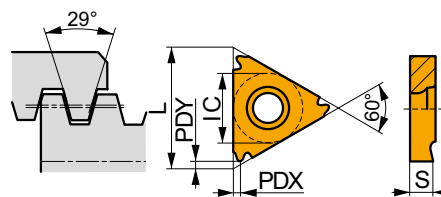

Idoneità e valori iniziali per velocità di taglio (Vc). Fare riferimento alla nostra App Machining Calculator per ulteriori calcoli.

Codice prodotto	RE (mm)	P	M	K	N	S	H	TP (mm)	TPI	PDX (mm)	PDY (mm)
		vc (m/min)	vc (m/min)	vc (m/min)	vc (m/min)	vc (m/min)	vc (m/min)				



TN ACME NR interno destro, per operazioni di filettatura ACME, taglio continuo.

TN 16NR120ACME	T8030	–	■ 160	■ 95	■ 150	▣ 480	▣ 40	–	–	12.0	1.5	1.3
TN 16NR100ACME	T8030	–	■ 160	■ 95	■ 150	▣ 480	▣ 40	–	–	10.0	1.5	1.3
TN 16NR080ACME	T8030¹⁾	–	■ 160	■ 95	■ 150	▣ 480	▣ 40	–	–	8.0	1.5	1.3
TN 22NR060ACME	T8030	–	■ 160	■ 95	■ 150	▣ 480	▣ 40	–	–	6.0	2.5	2.0
TN 22NR050ACME	T8030	–	■ 160	■ 95	■ 150	▣ 480	▣ 40	–	–	5.0	2.3	2.0



TN ACME NL interno sinistro, per operazioni di filettatura ACME, taglio continuo.

TN 16NL120ACME	T8030	–	■ 160	■ 95	■ 150	▣ 480	▣ 40	–	–	12.0	1.5	1.3
TN 16NL100ACME	T8030	–	■ 160	■ 95	■ 150	▣ 480	▣ 40	–	–	10.0	1.5	1.3
TN 16NL080ACME	T8030¹⁾	–	■ 160	■ 95	■ 150	▣ 480	▣ 40	–	–	8.0	1.5	1.3
TN 22NL060ACME	T8030	–	■ 160	■ 95	■ 150	▣ 480	▣ 40	–	–	6.0	2.5	2.0
TN 22NL050ACME	T8030	–	■ 160	■ 95	■ 150	▣ 480	▣ 40	–	–	5.0	2.3	2.0

¹⁾ I portautensili devono essere modificati.

NEW**TN STACME EXT****PRAMET**

	IC (mm)	L (mm)	S (mm)
16	9.525	16.50	3.47

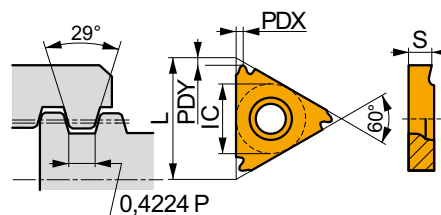

Idoneità e valori iniziali per velocità di taglio (Vc). Fare riferimento alla nostra App Machining Calculator per ulteriori calcoli.

Codice prodotto	RE (mm)	P vc (m/min)	M vc (m/min)	K vc (m/min)	N vc (m/min)	S vc (m/min)	H vc (m/min)	TP (mm)	TPI	PDX (mm)	PDY (mm)

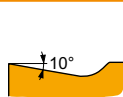
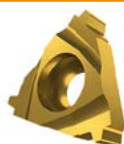

TN STACME ER esterno destro, adatto per filettatura Stub ACME, taglio continuo.

TN 16ER160STACME	T8030	–	■	160	■	95	■	150	☑	480	☑	40	–	–	16.0	0.8	0.8
TN 16ER120STACME	T8030	–	■	160	■	95	■	150	☑	480	☑	40	–	–	12.0	0.8	0.8
TN 16ER100STACME	T8030	–	■	160	■	95	■	150	☑	480	☑	40	–	–	10.0	1.5	1.3
TN 16ER080STACME	T8030	–	■	160	■	95	■	150	☑	480	☑	40	–	–	8.0	1.5	1.3
TN 16ER060STACME	T8030	–	■	160	■	95	■	150	☑	480	☑	40	–	–	6.0	1.4	1.3

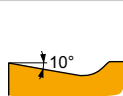

TN STACME EL esterno sinistro, adatto per filettatura Stub ACME, taglio continuo.

TN 16EL160STACME	T8030	–	■	160	■	95	■	150	☑	480	☑	40	–	–	16.0	0.8	0.8
TN 16EL120STACME	T8030	–	■	160	■	95	■	150	☑	480	☑	40	–	–	12.0	0.8	0.8
TN 16EL100STACME	T8030	–	■	160	■	95	■	150	☑	480	☑	40	–	–	10.0	1.5	1.3
TN 16EL080STACME	T8030	–	■	160	■	95	■	150	☑	480	☑	40	–	–	8.0	1.5	1.3
TN 16EL060STACME	T8030	–	■	160	■	95	■	150	☑	480	☑	40	–	–	6.0	1.4	1.3

NEW**TN STACME INT**

PRAMET

	IC (mm)	L (mm)	S (mm)
16	9.525	16.50	3.47

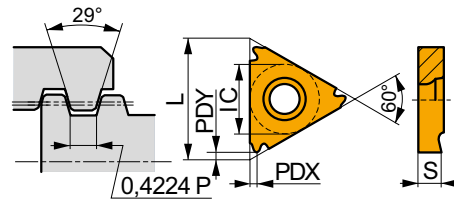

Idoneità e valori iniziali per velocità di taglio (Vc). Fare riferimento alla nostra App Machining Calculator per ulteriori calcoli.

Codice prodotto	RE (mm)	P	M	K	N	S	H	TP (mm)	TPI	PDX (mm)	PDY (mm)
		vc (m/min)	vc (m/min)	vc (m/min)	vc (m/min)	vc (m/min)	vc (m/min)				



TN STACME NR interno destro, adatto per filettatura Stub ACME, taglio continuo.

TN 16NR160STACME	T8030	–	■ 160	■ 95	■ 150	▣ 480	▣ 40	–	–	16.0	0.8	0.8
TN 16NR120STACME	T8030	–	■ 160	■ 95	■ 150	▣ 480	▣ 40	–	–	12.0	0.8	0.8
TN 16NR100STACME	T8030	–	■ 160	■ 95	■ 150	▣ 480	▣ 40	–	–	10.0	1.5	1.3
TN 16NR080STACME	T8030	–	■ 160	■ 95	■ 150	▣ 480	▣ 40	–	–	8.0	1.5	1.3
TN 16NR060STACME	T8030¹⁾	–	■ 160	■ 95	■ 150	▣ 480	▣ 40	–	–	6.0	1.3	1.3



TN STACME NL interno sinistro, adatto per filettatura Stub ACME, taglio continuo.

TN 16NL160STACME	T8030	–	■ 160	■ 95	■ 150	▣ 480	▣ 40	–	–	16.0	0.8	0.8
TN 16NL120STACME	T8030	–	■ 160	■ 95	■ 150	▣ 480	▣ 40	–	–	12.0	0.8	0.8
TN 16NL100STACME	T8030	–	■ 160	■ 95	■ 150	▣ 480	▣ 40	–	–	10.0	1.5	1.3
TN 16NL080STACME	T8030	–	■ 160	■ 95	■ 150	▣ 480	▣ 40	–	–	8.0	1.5	1.3
TN 16NL060STACME	T8030¹⁾	–	■ 160	■ 95	■ 150	▣ 480	▣ 40	–	–	6.0	1.3	1.3

¹⁾ I portautensili devono essere modificati.

TN API RD EXT

PRAMET

	IC (mm)	L (mm)	S (mm)
16	9.525	16.50	3.47

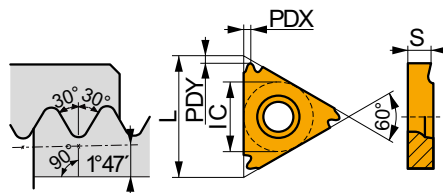

Idoneità e valori iniziali per velocità di taglio (Vc). Fare riferimento alla nostra App Machining Calculator per ulteriori calcoli.

Codice prodotto	RE (mm)	P	M	K	N	S	H	TP (mm)	TPI	PDX (mm)	PDY (mm)
		vc (m/min)	vc (m/min)	vc (m/min)	vc (m/min)	vc (m/min)	vc (m/min)				

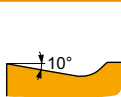

TN API ER esterno destro, per operazioni di filettatura API, taglio continuo.

TN 16ER100API-RD01	T8030	-	■	160	■	95	■	150	■	480	■	40	-	-	10.0	1.5	1.2
TN 16ER080API-RD01	T8030	-	■	160	■	95	■	150	■	480	■	40	-	-	8.0	1.5	1.2

TN API RD INT

PRAMET

	IC (mm)	L (mm)	S (mm)
16	9.525	16.50	3.47

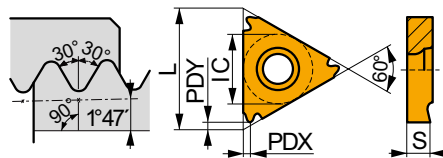

Idoneità e valori iniziali per velocità di taglio (Vc). Fare riferimento alla nostra App Machining Calculator per ulteriori calcoli.

Codice prodotto	RE (mm)	P	M	K	N	S	H	TP (mm)	TPI	PDX (mm)	PDY (mm)
		vc (m/min)	vc (m/min)	vc (m/min)	vc (m/min)	vc (m/min)	vc (m/min)				

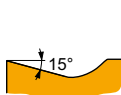

TN API NR interno destro, per operazioni di filettatura API, taglio continuo.

TN 16NR100API-RD01	T8030	-	■	160	■	95	■	150	■	480	■	40	-	-	10.0	1.5	1.2
TN 16NR080API-RD01	T8030	-	■	160	■	95	■	150	■	480	■	40	-	-	8.0	1.5	1.2

TN RD EXT

	IC (mm)	L (mm)	S (mm)
16	9.525	16.50	3.47
22	12.700	22.00	4.71

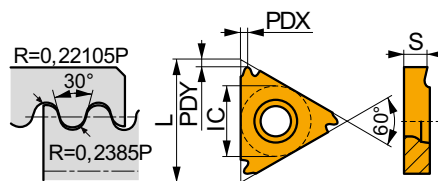

Idoneità e valori iniziali per velocità di taglio (Vc). Fare riferimento alla nostra App Machining Calculator per ulteriori calcoli.

Codice prodotto	RE (mm)	P	M	K	N	S	H	TP (mm)	TPI	PDX (mm)	PDY (mm)
		vc (m/min)	vc (m/min)	vc (m/min)	vc (m/min)	vc (m/min)	vc (m/min)				

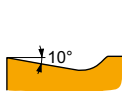

TN RD ER esterno destro, per operazioni di filettatura Metrica Tonda, taglio continuo.

TN 16ER100RD	T8030	–	■ 160	■ 95	■ 150	▣ 480	▣ 40	–	–	10.0	1.5	1.2
TN 16ER080RD	T8030	–	■ 160	■ 95	■ 150	▣ 480	▣ 40	–	–	8.0	1.5	1.2
TN 16ER060RD	T8030¹⁾	–	■ 160	■ 95	■ 150	▣ 480	▣ 40	–	–	6.0	1.5	1.2
TN 22ER060RD	T8030	–	■ 160	■ 95	■ 150	▣ 480	▣ 40	–	–	6.0	2.5	1.8

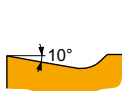

TN RD EL esterno sinistro, per operazioni di filettatura Metrica Tonda, taglio continuo.

TN 16EL100RD	T8030	–	■ 160	■ 95	■ 150	▣ 480	▣ 40	–	–	10.0	1.5	1.2
TN 16EL080RD	T8030	–	■ 160	■ 95	■ 150	▣ 480	▣ 40	–	–	8.0	1.5	1.2
TN 16EL060RD	T8030¹⁾	–	■ 160	■ 95	■ 150	▣ 480	▣ 40	–	–	6.0	1.5	1.2
TN 22EL060RD	T8030	–	■ 160	■ 95	■ 150	▣ 480	▣ 40	–	–	6.0	2.5	1.8

¹⁾ I portautensili devono essere modificati.

TN RD INT

	IC (mm)	L (mm)	S (mm)
16	9.525	16.50	3.47
22	12.700	22.00	4.71

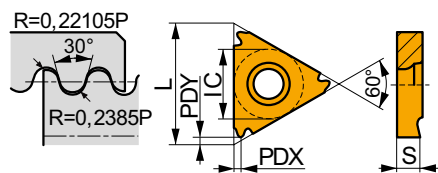

Idoneità e valori iniziali per velocità di taglio (Vc). Fare riferimento alla nostra App Machining Calculator per ulteriori calcoli.

Codice prodotto	RE (mm)	P	M	K	N	S	H	TP (mm)	TPI	PDX (mm)	PDY (mm)
		vc (m/min)	vc (m/min)	vc (m/min)	vc (m/min)	vc (m/min)	vc (m/min)				

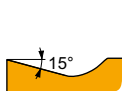

TN RD NR interno destro, per operazioni di filettatura Metrica Tonda, taglio continuo.

TN 16NR100RD	T8030	–	■ 160	■ 95	■ 150	▣ 480	▣ 40	–	–	10.0	1.5	1.2
TN 16NR080RD	T8030	–	■ 160	■ 95	■ 150	▣ 480	▣ 40	–	–	8.0	1.5	1.2

Idoneità e valori iniziali per velocità di taglio (Vc). Fare riferimento alla nostra App Machining Calculator per ulteriori calcoli.

Codice prodotto		RE (mm)	P	M	K	N	S	H	TP (mm)	TPI	PDX (mm)	PDY (mm)
			vc (m/min)	vc (m/min)	vc (m/min)	vc (m/min)	vc (m/min)	vc (m/min)				



TN RD NR interno destro, per operazioni di filettatura Metrica Tonda, taglio continuo.

TN 16NR060RD	T8030¹⁾	–	■ 160	■ 95	■ 150	▣ 480	▣ 40	–	–	6.0	1.5	1.2
TN 22NR060RD	T8030	–	■ 160	■ 95	■ 150	▣ 480	▣ 40	–	–	6.0	2.5	1.8



TN RD NL interno sinistro, per operazioni di filettatura Metrica Tonda, taglio continuo.

TN 16NL100RD	T8030	–	■ 160	■ 95	■ 150	▣ 480	▣ 40	–	–	10.0	1.5	1.2
TN 16NL080RD	T8030	–	■ 160	■ 95	■ 150	▣ 480	▣ 40	–	–	8.0	1.5	1.2
TN 16NL060RD	T8030¹⁾	–	■ 160	■ 95	■ 150	▣ 480	▣ 40	–	–	6.0	1.5	1.2
TN 22NL060RD	T8030	–	■ 160	■ 95	■ 150	▣ 480	▣ 40	–	–	6.0	2.5	1.8

¹⁾ I portautensili devono essere modificati.

SE(RL)



PRAMET

S

Utensile per filettatura esterna con bloccaggio a vite per inserti TN 16 o 22

Utensile destro/sinistro per filettature esterne con bloccaggio a vite per inserti di filettatura TN16 o TN22 ER/EL. Adatto per filettature con profilo metrico o in pollici. Adatto anche per scanalature poco profonde (anelli Seeger). Corpi trattati per una maggiore durata.

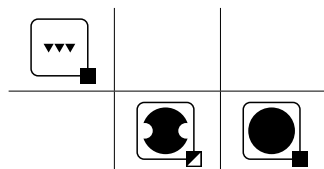
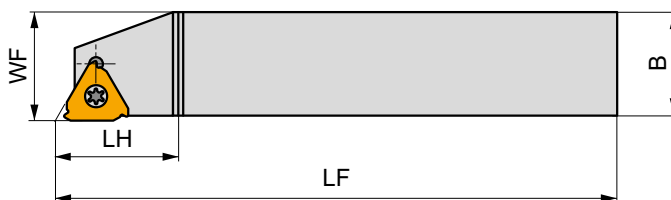
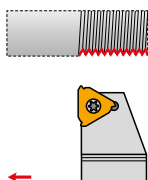

Codice prodotto	H	H _F	B	WF	LF	H	LAMS		
	(mm)	(mm)	(mm)	(mm)	(mm)	(mm)	(°)		
R SER 2020 K 16	20	20	20	20	125	22.5	–	GI068	Z12
SER 2525 M 16	25	25	25	25	150	24	–	GI068	Z12
SER 3225 P 16	32	32	25	25	170	24.5	–	GI068	Z12
SER 2525 M 22-A	25	25	25	25	150	25.5	–	GI071	Z13
SER 3225 P 22-A	32	32	25	25	170	25.5	–	GI071	Z13
L SEL 2020 K 16	20	20	20	20	125	22.5	–	GI068	Z12
SEL 2525 M 16	25	25	25	25	150	24	–	GI068	Z12
SEL 3225 P 16	32	32	25	25	170	24.5	–	GI068	Z12
SEL 2525 M 22-A	25	25	25	25	150	25.5	–	GI071	Z13
SEL 3225 P 22-A	32	32	25	25	170	25.5	–	GI071	Z13

GI068	TN 16ER..	TN 16EL..
GI071	TN 22ER..	TN 22EL..

Z12	US 3512A-T15P	3.0	M 3.5	12.7	–	HS 0304	FLAG T15P	HXK 2.5	604
Z13	US 4514A-T20	5.0	M 4.5	14	SP 0405	–	FLAG T20	–	604

SE(RL)-S



PRAMET

S



Utensile per filettatura esterna con bloccaggio a vite per inserti neutri TN22

Utensile destro/sinistro per filettature esterne con bloccaggio a vite per inserto di filettatura TN22 EN per passi di grandi dimensioni. Adatto per filettature con profilo metrico o in pollici. Corpi trattati per una maggiore durata.

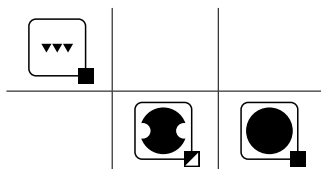
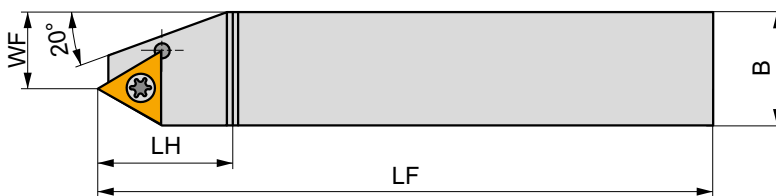
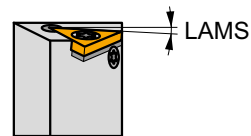
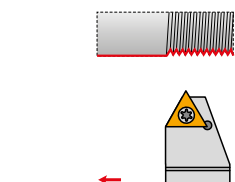

Codice prodotto		H	HF	B	WF	LF	LH	LAMS		
		(mm)	(mm)	(mm)	(mm)	(mm)	(mm)	(°)		
R	SER-S 2525 M 22-A	25	25	25	14	150	30	-	G1086	Z15
	SER-S 3225 P 22-A	32	32	25	14	170	30	-	G1086	Z15
L	SEL-S 2525 M 22-A	25	25	25	14	150	30	-	G1086	Z15
	SEL-S 3225 P 22-A	32	32	25	14	170	30	-	G1086	Z15



G1086



TN 22EN..



Z15



US 4514A-T20



5.0



M 4.5



14



SP 0405



FLAG T20



604

SI(RL)



PRAMET

S





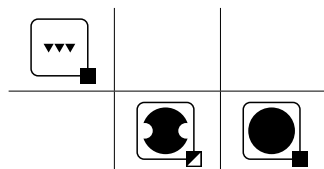
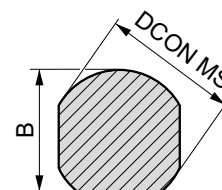
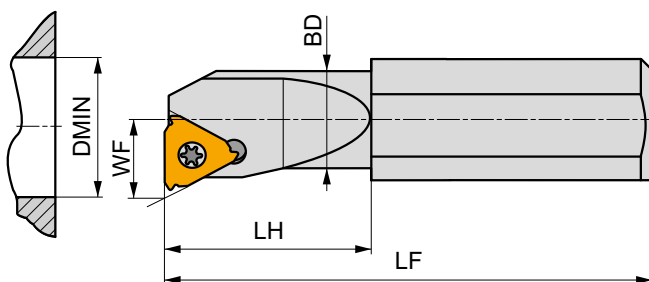
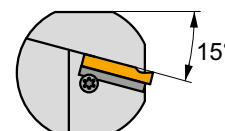
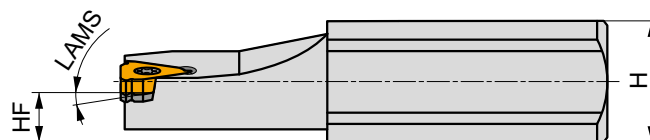
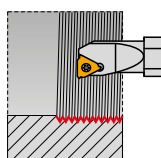







Utensile per filettatura interna con bloccaggio a vite per inserti TN 11, TN 16 e TN 22

Utensile destro/sinistro per filettature interne con bloccaggio a vite per inserti di filettatura TN 11, 16 o 22 NR/NL. Adatto per filettature con profilo metrico o in pollici. Diametro interno minimo Ø13 mm. Adatto anche per scanalature poco profonde (anelli Seeger). Disponibile con dimensioni dello stelo da Ø16 a Ø40 mm. Corpi trattati per una maggiore durata.



Codice prodotto	B	DCON MS	DMIN	BD	WF	H	HF	LF	LH	LAMS	Icona 1	Icona 2	Icona 3
	(mm)	(mm)	(mm)	(mm)	(mm)	(mm)	(mm)	(mm)	(mm)	(°)			
R SIR 0010 K 11-0	14.5	16	13	10	7.45	14	7	125	25	0	–	GI085	Z11
SIR 0010 K 11-1	14.5	16	13	10	7.45	14	7	125	25	1	–	GI085	Z11
SIR 0013 M 11-0	14.5	16	16	13	9	14	7	150	32	0	–	GI085	Z11
SIR 0013 M 11-1	14.5	16	16	13	9	14	7	150	32	1	–	GI085	Z11
SIR 1416 N 16-0	14	16	22	17	11.4	14.5	7.5	160	–	0	–	GI022	Z9
SIR 1416 N 16-1	14	16	22	17	11.4	14.5	7.5	160	–	1	–	GI022	Z9
SIR 1416 N 16-2	14	16	16.5	15.5	10.6	14.5	7.5	160	40	2	✓	GI022	Z10
SIR 1820 P 16	18.5	20	27	21	13.85	18	9	170	–	–	–	GI022	Z12
SIR 2325 Q 16	23.5	25	29	26	16.55	23	11.5	180	–	–	–	GI022	Z12
SIR 2532 S 16	30	32	36	32	19.75	25	12.5	250	–	–	–	GI022	Z12
SIR 2532 S 22-2	30	32	25	25	16.65	25	12.5	250	80	2	✓	GI076	Z14
SIR 2532 S 22-A	30	32	36	32	21.65	25	12.5	250	–	–	–	GI076	Z13
SIR 3240 T 22-A	38	40	48	40	25.85	32	16	300	–	–	–	GI076	Z13
L SIL 0010 K 11-0	14.5	16	13	10	7.45	14	7	125	25	0	–	GI085	Z11
SIL 0010 K 11-1	14.5	16	13	10	7.55	14	7	125	25	1	–	GI085	Z11
SIL 0013 M 11-0	14.5	16	16	13	9	14	7	150	32	0	–	GI085	Z11
SIL 0013 M 11-1	14.5	16	16	13	9	14	7	150	32	1	–	GI085	Z11
SIL 1416 N 16-0	14	16	22	17	11.4	14.5	7.5	160	–	0	–	GI022	Z9
SIL 1416 N 16-1	14	16	22	17	11.4	14.5	7.5	160	–	1	–	GI022	Z9
SIL 1416 N 16-2	14	16	16.5	15.5	10.6	14.5	7.5	160	40	2	✓	GI022	Z10
SIL 1820 P 16	18.5	20	27	21	13.85	18	9	170	–	–	–	GI022	Z12
SIL 2325 Q 16	23.5	25	29	26	16.55	23	11.5	180	–	–	–	GI022	Z12
SIL 2532 S 16	30	32	36	32	19.75	25	12.5	250	–	–	–	GI022	Z12
SIL 2532 S 22-2	30	32	25	25	16.65	25	12.5	250	80	2	✓	GI076	Z14
SIL 2532 S 22-A	30	32	36	32	21.65	25	12.5	250	–	–	–	GI076	Z13
SIL 3240 T 22-A	38	40	48	40	25.85	32	16	300	–	–	–	GI076	Z13

		
GI022	TN 16NR..	TN 16NL..
GI076	TN 22NR..	TN 22NL..
GI085	TN 11NR..	TN 11NL..

									
Z10	US 3510A-T15P	3.0	M 3.5	10.6	-	-	FLAG T15P	-	-
Z11	US 2506-T07P	0.9	M 2.5	6.3	-	-	FLAG T07P	-	-
Z12	US 3512A-T15P	3.0	M 3.5	12.7	-	HS 0304	FLAG T15P	HXK 2.5	 604
Z13	US 4514A-T20	5.0	M 4.5	14	SP 0405	-	FLAG T20	-	 604
Z14	US 4514A-T20	5.0	M 4.5	14	-	-	FLAG T20	-	-
Z9	US 3510A-T15P	3.0	M 3.5	10.6	-	-	FLAG T15P	-	P-16

SI(RL)-S

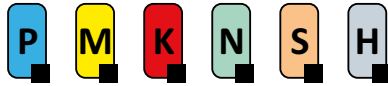

PRAMET

S



Utensile per filettatura interna con bloccaggio a vite per inserto neutro TN 22

Utensile destro/sinistro per filettature interne con bloccaggio a vite per inserto di filettatura TN 22 NN. Adatto per filettature con profilo metrico o in pollici. Diametro interno minimo Ø39 mm. Disponibile con dimensioni dello stelo da Ø32 a Ø40 mm. Corpi trattati per una maggiore durata.

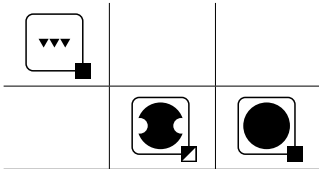
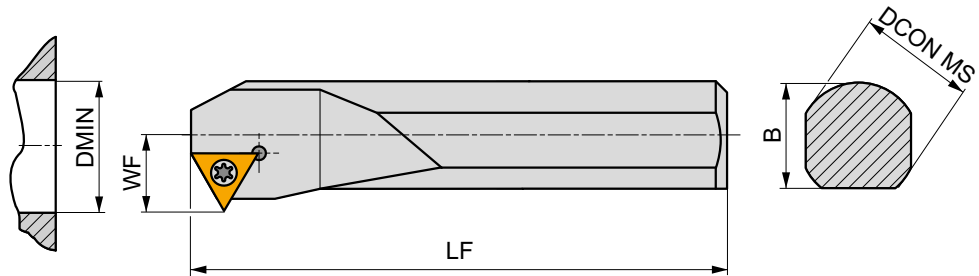
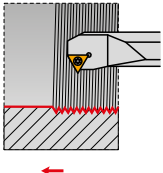

Codice prodotto	B (mm)	DCON MS (mm)	DMIN (mm)	WF (mm)	H (mm)	HF (mm)	LF (mm)	LAMS (°)		
R SIR-S 2532 S 22-A	30	32	39	22.3	25	12.5	250	-	G1107	Z15
SIR-S 3240 T 22-A	38	40	48	27	32	16	300	-	G1107	Z15
L SIL-S 2532 S 22-A	30	32	39	22.3	25	12.5	250	-	G1107	Z15
SIL-S 3240 T 22-A	38	40	48	27	32	16	300	-	G1107	Z15



G1107



TN 22NN..



Z15



US 4514A-T20



Nm

5.0



M 4.5



14



SP 0405



FLAG T20



604



TUTTI I MATERIALI

Lavorazione di acciaio, acciaio inossidabile, ghisa, superleghe o materiali non ferrosi, tutti sono coperti dalla nostra App per il calcolo dei parametri. Scaricatela dal vostro app store oggi stesso. **Semplicemente affidabili.**

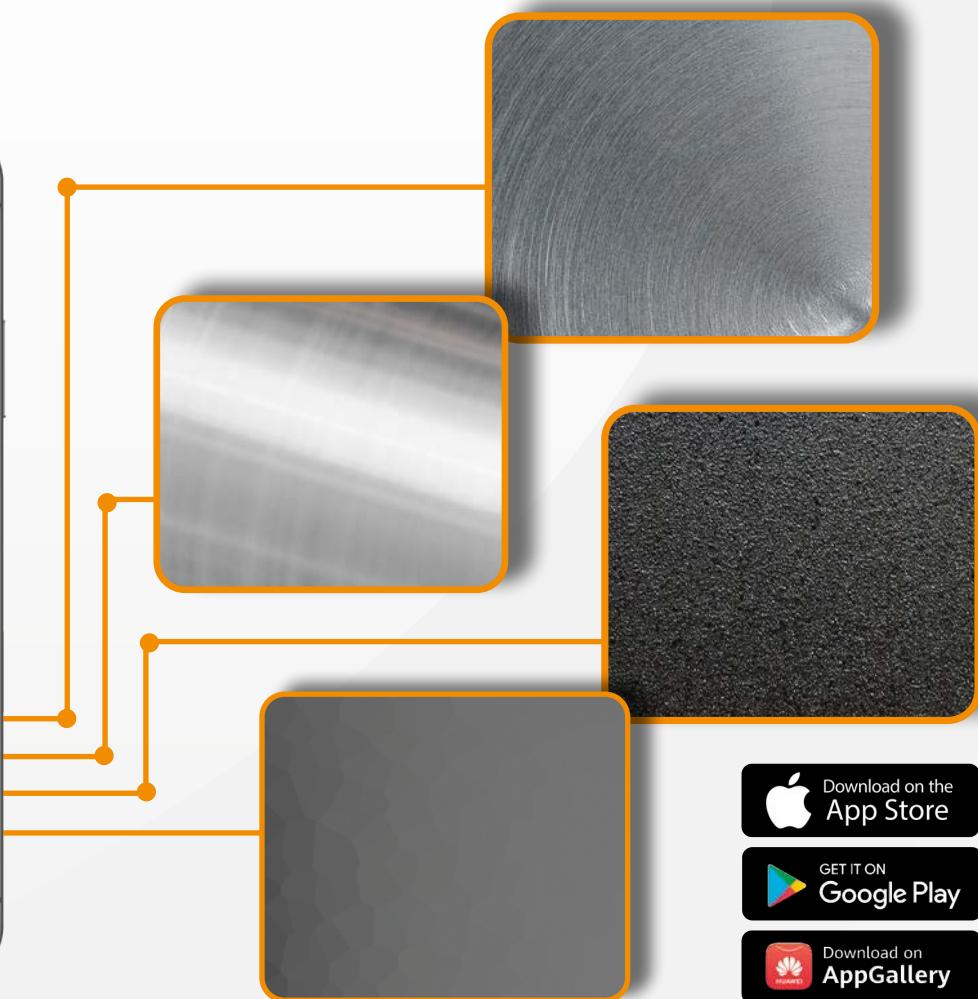
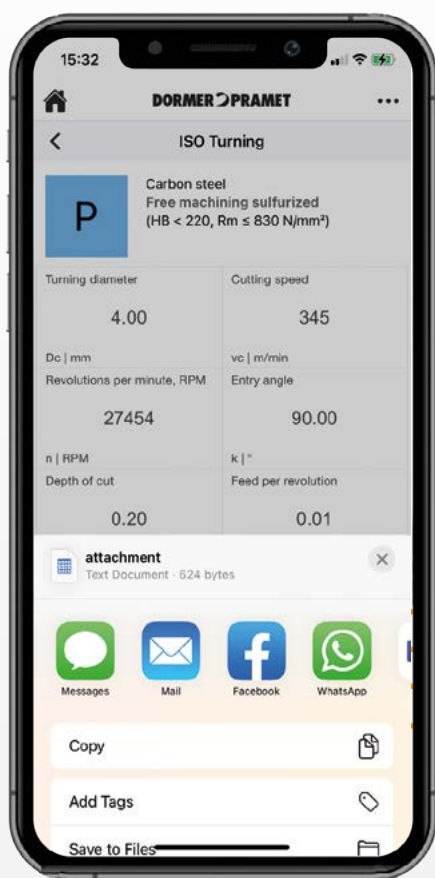

STOZZATURA











TORNITURA – CONTENUTO GENERALE



 6		WMG & ISO 13399
 10	TORNITURA ISO	ISTRUZIONI
 18		NAVIGATORE
 57		INSERTI POSITIVI
 219		INSERTI NEGATIVI
 386		TRONCATURA E SCANALATURA
 482		FILETTATURA
 528		STOZZATURA
 536		INFORMAZIONI TECNICHE GENERALI

STOZZATURA – PANORAMICA DELLE ICONE

ICONE GENERALI

	Utilizzo primario		Finitura – ottima qualità superficiale		Adatto a condizioni di lavorazione stabili
	Utilizzo possibile		Lavorazione media – buona qualità superficiale		Adatto a condizioni di lavorazione instabili
			Sgrossatura – rugosità superficiale illimitata		Adatto a condizioni di lavorazione molto instabili





CARATTERISTICHE

	Lavorazione interna		Ampia gamma di opzioni universali		Tagliente affilato
--	---------------------	---	-----------------------------------	---	--------------------







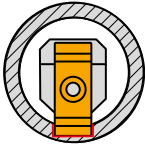

ALTRO

	Coppia di bloccaggio della vite [Nm]		Alimentazione interna del refrigerante
--	--------------------------------------	---	--

INSERTI PER STOZZATURA – NAVIGATORE

HZ	HZ-2
	
 531	 532

UTENSILI PER STOZZATURA – NAVIGATORE

PHZ		PHZ-2	
	HZ		HZ/2..
			
	03		14
	04		16
	05		18
	06		20
08			
10			
12			
 $\frac{\varnothing 9,5}{\varnothing 24,7}$	 $\frac{\varnothing 44}{\varnothing 58}$		
 533	 531	 534	 532

HZ

	IC	INSL	APMX	S	S1	CW
	(mm)	(mm)	(mm)	(mm)	(mm)	(mm)
0604-30	6.000	7.5	1.60	4.66	4.76	3.00
0604-40	6.000	8.0	2.50	4.66	4.76	4.00
0604-50	6.000	8.0	3.00	4.66	4.76	5.00
1006-60	10.000	13.5	4.20	6.25	6.35	6.00
1006-80	10.000	13.5	5.20	6.25	6.35	8.00
1309-100	13.000	18.5	6.20	9.40	9.53	10.00
1309-120	13.000	18.5	7.20	9.40	9.53	12.00

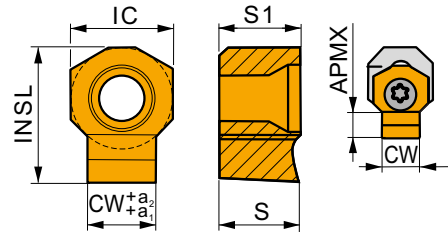

Idoneità e valori iniziali per velocità di taglio (Vc) e avanzamento (fz). Fare riferimento alla nostra App Machining Calculator per ulteriori calcoli.

Codice prodotto	RE	P		M		K		N		S		H		CW	CWTOLL	CWTOLU
		vc	fz	vc	fz	vc	fz	vc	fz	vc	fz	vc	fz			
	(mm)	(m/min)	(mm/tooth)	(m/min)	(mm/tooth)	(m/min)	(mm/tooth)	(m/min)	(mm/tooth)	(m/min)	(mm/tooth)	(m/min)	(mm/tooth)	(mm)	(mm)	(mm)

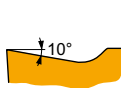

Geometria positiva per la stozzatura (mono tagliente).

HZ 1006-60 C11	333TN	-	50	0.10	30	0.09	45	0.10	-	-	-	-	6.00	0.07	0.14
HZ 1006-60 D10	333TN	-	50	0.10	30	0.09	45	0.10	-	-	-	-	6.00	0.03	0.08
HZ 1006-60 H7	333TN	-	50	0.10	30	0.09	45	0.10	-	-	-	-	6.00	0.00	0.01
HZ 1006-60 P9	333TN	-	50	0.10	30	0.09	45	0.10	-	-	-	-	6.00	-0.04	-0.01
HZ 1006-80 C11	333TN	-	50	0.10	30	0.09	45	0.10	-	-	-	-	8.00	0.08	0.17
HZ 1006-80 D10	333TN	-	50	0.10	30	0.09	45	0.10	-	-	-	-	8.00	0.04	0.10
HZ 1006-80 H7	333TN	-	50	0.10	30	0.09	45	0.10	-	-	-	-	8.00	0.00	0.02
HZ 1006-80 P9	333TN	-	50	0.10	30	0.09	45	0.10	-	-	-	-	8.00	-0.05	-0.02
HZ 1309-100 C11	333TN	-	50	0.10	30	0.09	45	0.10	-	-	-	-	10.00	0.08	0.17
HZ 1309-100 D10	333TN	-	50	0.10	30	0.09	45	0.10	-	-	-	-	10.00	0.04	0.10
HZ 1309-100 H7	333TN	-	50	0.10	30	0.09	45	0.10	-	-	-	-	10.00	0.00	0.02
HZ 1309-100 P9	333TN	-	50	0.10	30	0.09	45	0.10	-	-	-	-	10.00	-0.05	-0.02
HZ 1309-120 C11	333TN	-	50	0.10	30	0.09	45	0.10	-	-	-	-	12.00	0.10	0.21
HZ 1309-120 D10	333TN	-	50	0.10	30	0.09	45	0.10	-	-	-	-	12.00	0.05	0.12
HZ 1309-120 H7	333TN	-	50	0.10	30	0.09	45	0.10	-	-	-	-	12.00	0.00	0.02
HZ 1309-120 P9	333TN	-	50	0.10	30	0.09	45	0.10	-	-	-	-	12.00	-0.06	-0.02
HZ90 0604-30 C11	333TN	-	50	0.10	30	0.09	45	0.10	-	-	-	-	3.00	0.06	0.12
HZ90 0604-30 D10	333TN	-	50	0.10	30	0.09	45	0.10	-	-	-	-	3.00	0.02	0.06
HZ90 0604-30 H7	333TN	-	50	0.10	30	0.09	45	0.10	-	-	-	-	3.00	0.00	0.01
HZ90 0604-30 P9	333TN	-	50	0.10	30	0.09	45	0.10	-	-	-	-	3.00	-0.03	-0.01
HZ90 0604-40 C11	333TN	-	50	0.10	30	0.09	45	0.10	-	-	-	-	4.00	0.07	0.14
HZ90 0604-40 D10	333TN	-	50	0.10	30	0.09	45	0.10	-	-	-	-	4.00	0.03	0.08
HZ90 0604-40 H7	333TN	-	50	0.10	30	0.09	45	0.10	-	-	-	-	4.00	0.00	0.01
HZ90 0604-40 P9	333TN	-	50	0.10	30	0.09	45	0.10	-	-	-	-	4.00	-0.04	-0.01
HZ90 0604-50 C11	333TN	-	50	0.10	30	0.09	45	0.10	-	-	-	-	5.00	0.07	0.14
HZ90 0604-50 D10	333TN	-	50	0.10	30	0.09	45	0.10	-	-	-	-	5.00	0.03	0.08
HZ90 0604-50 H7	333TN	-	50	0.10	30	0.09	45	0.10	-	-	-	-	5.00	0.00	0.01
HZ90 0604-50 P9	333TN	-	50	0.10	30	0.09	45	0.10	-	-	-	-	5.00	-0.04	-0.01

HZ-2

	INSL (mm)	APMX (mm)	S (mm)	S1 (mm)	CW (mm)
14-14	36.0	8.00	13.90	14.00	14.00
16-16	36.0	9.00	13.90	14.00	16.00
18-18	45.0	12.00	15.90	16.00	18.00
20-20	45.0	13.00	15.90	16.00	20.00

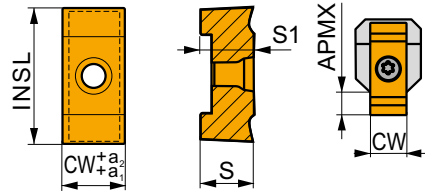

Idoneità e valori iniziali per velocità di taglio (Vc) e avanzamento (fz). Fare riferimento alla nostra App Machining Calculator per ulteriori calcoli.

Codice prodotto	RE (mm)	P		M		K		N		S		H		CW (mm)	CWTOLL (mm)	CWTOLU (mm)
		vc (m/min)	fz (mm/tooth)	vc (m/min)	fz (mm/tooth)	vc (m/min)	fz (mm/tooth)	vc (m/min)	fz (mm/tooth)	vc (m/min)	fz (mm/tooth)	vc (m/min)	fz (mm/tooth)			

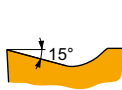

Geometria positiva per la stozzatura (bi-tagliente).

HZ/2 14-14 C11	333TN	-	50	0.10	30	0.09	45	0.10	-	-	-	-	-	14.00	0.10	0.21
HZ/2 14-14 H7	333TN	-	50	0.10	30	0.09	45	0.10	-	-	-	-	-	14.00	0.00	0.02
HZ/2 14-14 P9	333TN	-	50	0.10	30	0.09	45	0.10	-	-	-	-	-	14.00	-0.06	-0.02
HZ/2 16-16 C11	333TN	-	50	0.10	30	0.09	45	0.10	-	-	-	-	-	16.00	0.10	0.21
HZ/2 16-16 H7	333TN	-	50	0.10	30	0.09	45	0.10	-	-	-	-	-	16.00	0.00	0.02
HZ/2 16-16 P9	333TN	-	50	0.10	30	0.09	45	0.10	-	-	-	-	-	16.00	-0.06	-0.02
HZ/2 18-18 C11	333TN	-	50	0.10	30	0.09	45	0.10	-	-	-	-	-	18.00	0.10	0.21
HZ/2 18-18 H7	333TN	-	50	0.10	30	0.09	45	0.10	-	-	-	-	-	18.00	0.00	0.02
HZ/2 18-18 P9	333TN	-	50	0.10	30	0.10	45	0.10	-	-	-	-	-	18.00	-0.06	-0.02
HZ/2 20-20 C11	333TN	-	50	0.10	30	0.09	45	0.10	-	-	-	-	-	20.00	0.11	0.24
HZ/2 20-20 H7	333TN	-	50	0.10	30	0.09	45	0.10	-	-	-	-	-	20.00	0.00	0.02
HZ/2 20-20 P9	333TN	-	50	0.10	30	0.10	45	0.10	-	-	-	-	-	20.00	-0.07	-0.02

PHZ



PRAMET

S



Utensile Stozzatore interno per piccoli diametri con inserti HZ a tagliente singolo

Utensile per Stozzatura interna fino a 12 mm di larghezza di taglio. Diametro minimo di ingresso Ø9.5 mm. Corpo trattato per una maggiore durata.

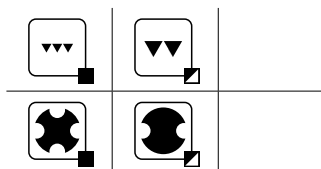
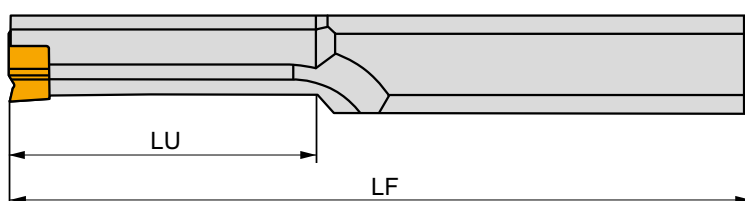
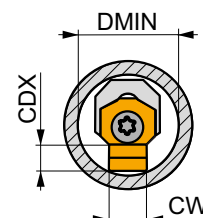
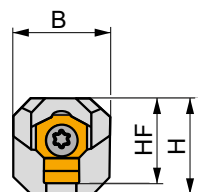
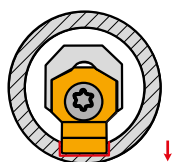

Codice prodotto	H	HF	B	OAL	LU	CW	DMIN	CDX	kg	G	S	
	(mm)	(mm)	(mm)	(mm)	(mm)	(mm)	(mm)					
N	PHZ 90 1104-06	11.3	9	8.5	160	35	3.00	9.5	1.6	0.17	GI239	SH21
	PHZ 90 1107-06	11.3	10	7	200	60	-	-	-	0.19	GI240	SH21
	PHZ 90 1111-06	11.3	12	-	200	60	-	-	-	0.19	GI240	SH21
	PHZ 1512-10	15.5	16.2	-	220	-	-	-	-	0.40	GI224	SH22
	PHZ 2014-13	20.6	21.5	-	250	-	-	-	-	0.65	GI225	SH23

GI224	HZ 1006-60	HZ 1006-80
GI225	HZ 1309-100	HZ 1309-120
GI239	HZ90 0604-30	-
GI240	HZ90 0604-40	HZ90 0604-50

		Nm			
SH21	DVF 3593	0.8	M 2.5	10	TX207PLUS
SH22	DVF 2260	3.6	M 4	15	TX215PLUS
SH23	5513 020-14	8.5	M 6	18	TX225PLUS

PHZ-2

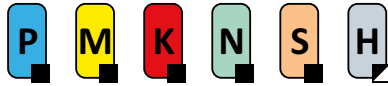

PRAMET

S



Utensile Stozzatore interno per grandi diametri con inserti HZ a doppio tagliente

Utensile per Stozzatura interna fino a 20 mm di larghezza di taglio. Diametro minimo di ingresso Ø44 mm. Corpo trattato per una maggiore durata.

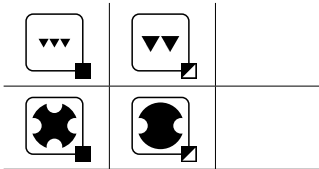
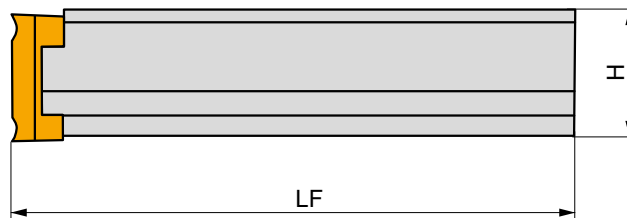
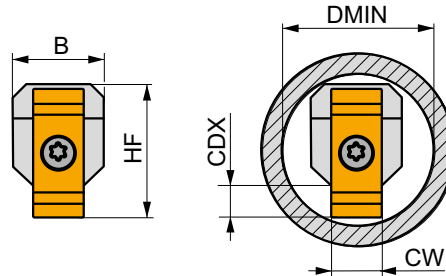
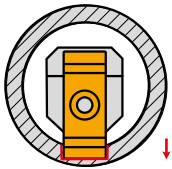

Codice prodotto	H	HF	B	OAL	CW	DMIN	CDX	kg	GI235	SH23
	(mm)	(mm)	(mm)	(mm)	(mm)	(mm)	(mm)			
N PHZ/2 3625-14	36	37.5	25	300	-	44	-	1.86	GI235	SH23
PHZ/2 4832-18	48	50	32	400	-	58	-	2.00	GI241	SH24

GI235	Inserto	Inserto
GI235	HZ/2 14-14	HZ/2 16-16
GI241	HZ/2 18-18	HZ/2 20-20

SH23	5513 020-14	Nm	M 6	18	TX225PLUS
SH24	5513 021-03	13.0	M 8	22	DMN 3124



L'AIUTO A PORTATA DI MANO

Il nostro team di supporto tecnico è sempre a disposizione per aiutarvi con qualsiasi domanda tecnica o quesito sulle nostre app tecniche. Utilizzate i dettagli di contatto per contattare il vostro ufficio commerciale Dormer Pramet locale. **Semplicemente affidabili.**

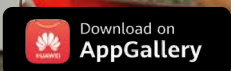
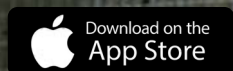
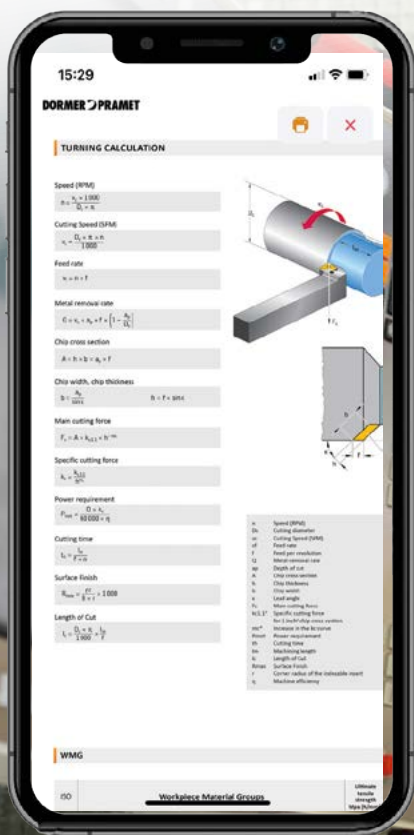

**INFORMAZIONI
TECNICHE GENERALI**



TORNITURA – CONTENUTO GENERALE

 6		WMG & ISO 13399
 10	TORNITURA ISO	ISTRUZIONI
 18		NAVIGATORE
 57		INSERTI POSITIVI
 219		INSERTI NEGATIVI
 386		TRONCATURA E SCANALATURA
 482		FILETTATURA
 528		STOZZATURA
 536		INFORMAZIONI TECNICHE GENERALI

GRUPPO DEI MATERIALI LAVORATI (WMG)

ISO Per selezionare qualità e geometria di taglio per una vasta gamma di materiali lavorati

Definizione generale
per es. acciaio, acciaio inox...

P **M** **K** **N** **S** **H**

Sottogruppo Per navigare e selezionare l'utensile più adatto per una più specifica gamma di materiali lavorati

Definizione in funzione della struttura/composizione
per es. acciaio al carbonio, acciaio legato...

P **M** **K** **N** **S** **H**

P1

P2

P3

P4

WMG Per selezionare e fornire condizioni di taglio con un margine di $\pm 10\%$

Definizione in funzione della durezza/massima resistenza a trazione
per es. 160 < 220HB, 620 < 900 n/mm² ...

P

P1 **P1.1** **P1.2** **P1.3**

P2 **P2.1** **P2.2** **P2.3**

P3 **P3.1** **P3.2** **P3.3**

P4 **P4.1** **P4.2** **P4.3**

CLASSIFICAZIONE DEI MATERIALI LAVORATI SECONDO DORMER PRAMET

La classificazione dei materiali da lavorare (WMG) permette una scelta semplice ed affidabile del corretto utensile da taglio e dei valori di partenza adatti in condizioni di lavoro particolari.

Dormer Pramet classifica i materiali da lavorare in sei gruppi di differenti colori:

- **Blu:** acciaio e acciaio fuso (gruppo P)
- **Giallo:** acciaio inox (gruppo M)
- **Rosso:** ghisa (gruppo K)
- **Verde:** metalli non ferrosi (gruppo N)
- **Marrone:** leghe ad alta temperatura (gruppo S)
- **Grigio:** materiali temprati (gruppo H)

Ognuno di questi gruppi è suddiviso in sottogruppi sulla base della loro struttura e/o composizione. Ad esempio, il gruppo P, dell'acciaio e acciaio fuso, è diviso in quattro sottogruppi, vale a dire;

- **P1 – Acciaio a buona lavorabilità**
- **P2 – Acciaio al carbonio non legato**
- **P3 – Acciaio legato**
- **P4 – Acciaio per utensili**

Un'ultima divisione viene fatta secondo le proprietà dei materiali, come la durezza e la massima resistenza a trazione. Questo per fornire ai nostri clienti una raccomandazione completa dell'utensile, compresi i valori iniziali per velocità di taglio ed avanzamento.

La tabella nella pagina successiva include una descrizione di ciascun gruppo di materiali lavorati, nonché alcuni esempi di denominazione comunemente usata.

Gruppo ISO	Sottogruppo	WMG (Gruppo dei materiali lavorati)	k_{α}	Esempi di materiali (AISI, EN, DIN, ČSN, GB, SS, STN, BS, UNE, AFNOR, ASTM, GOST, UNS, UNI, ...)
P Acciaio e acciaio fuso (acciai con contenuto di lega ≤ 10 % e durezza < 45HRC)	P1 Acciaio buona lavorabilità (acciai al carbonio con lavorabilità aumentata)	P1.1 Acciaio al carbonio solforizzato buona lavorabilità con durezza < 240 HB	1.33	AISI 1108, EN 1552, DIN 1.0723, SS 1922, ČSN 11120, BS 210A15, UNE F.210F, GB Y15, AFNOR 10F1, GOST A30, UNI CF10S20
		P1.2 Acciaio al carbonio solforizzato e fosforizzato buona lavorabilità con durezza < 180 HB	1.49	AISI 1211, EN 115Mn30, DIN 1.0715, SS 1912, ČSN 11109, BS 230M7, UNE F.2111, GB Y15, AFNOR S250, GOST A40G, UNI CF9SMn28
		P1.3 Acciaio al carbonio solforizzato/ fosforizzato al Pb buona lavorabilità con durezza < 180 HB	1.53	AISI 12L13, EN 115MnPb30, DIN 1.0718, SS 1914, ČSN 12110, BS 210M16, UNE F.2114, GB Y15Pb, AFNOR S250Pb, GOST AS35G2, UNI CF10SPb20
	P2 Acciaio non legato al carbonio (acciai composti principalmente da ferro e carbonio)	P2.1 Acciaio non legato a basso tenore di carbonio contenente < 0,25 % C con durezza < 180 HB	1.14	AISI 1015, EN C15, DIN 1.0401, SS 1350, ČSN 11301, BS 080A15, UNE F.111, GB 15, AFNOR C18RR, GOST S22ps, UNI Fe360
		P2.2 Acciaio non legato a medio tenore di carbonio contenente < 0,55 % C con durezza < 240 HB	1.00	AISI 1030, EN C30, DIN 1.0528, SS 1550, ČSN 12031, BS 080M32, UNE F.1130, GB 30, AFNOR AF50C30, GOST 30G, UNI Fe590
		P2.3 Acciaio non legato ad alto tenore di carbonio contenente < 0,55 % C con durezza < 300 HB	0.89	AISI 1060, EN C60, DIN 1.0601, SS 1655, ČSN 12061, BS 080A62, UNE F513, GB 60, AFNOR 1C60, GOST 60G, UNI C60
	P3 Acciaio legato (acciai al carbonio con contenuto legante ≤ 10 %)	P3.1 Acciaio legato con durezza < 180 HB	0.92	AISI 5015, EN 16Mo3, DIN 1.5415, SS 2912, ČSN 15020, BS 1501-240, UNE F.2601, GB 16Mo, AFNOR 15D3, GOST 15M, UNI 16Mo3KW
		P3.2 Acciaio legato con durezza 180 – 260 HB	0.74	AISI 4140, EN 42CrMo4, DIN 1.7225, SS 2244, ČSN 15142, BS 708M40, UNE F.8232, GB 42CrMo, AFNOR 42CD4, GOST 40CHFA, UNI 42CrMo4
		P3.3 Acciaio legato con durezza 260 – 360 HB	0.63	AISI 4140, EN 42CrMo4, DIN 1.7225, SS 2244, ČSN 15142, BS 708M40, UNE F.8232, GB 42CrMo, AFNOR 42CD4, GOST 40CHFA, UNI 42CrMo4
	P4 Acciaio per utensili (acciaio legato speciale per utensili, filiere e stampi)	P4.1 Acciaio per utensili con durezza < 26 HB	0.55	AISI D2, EN X155CrVMo12-1, DIN 1.2370, SS 2736, ČSN 19573, BS BD2, UNE F.520A, GB Cr12Mo1V1, AFNOR Z160CDV12, GOST Ch12MF, UNI X155CrVMo121KU
		P4.2 Acciaio per utensili con durezza 26 – 39 HRC	0.47	AISI D2, EN X155CrVMo12-1, DIN 1.2370, SS 2736, ČSN 19573, BS BD2, UNE F.520A, GB Cr12Mo1V1, AFNOR Z160CDV12, GOST Ch12MF, UNI X155CrVMo121KU
		P4.3 Acciaio per utensili con durezza 39 – 45 HRC	0.38	AISI D2, EN X155CrVMo12-1, DIN 1.2370, SS 2736, ČSN 19573, BS BD2, UNE F.520A, GB Cr12Mo1V1, AFNOR Z160CDV12, GOST Ch12MF, UNI X155CrVMo121KU

Gruppo ISO	Sottogruppo	WMG (Gruppo dei materiali lavorati)	k _{vg}	Esempi di materiali (AISI, EN, DIN, ČSN, GB, SS, STN, BS, UNE, AFNOR, ASTM, GOST, UNS, UNI, ...)
M Acciaio inossidabile (acciai resistenti alla corrosione con contenuto di cromo ≥ 11 %)	M1 Acciaio inossidabile ferritico (leghe normali al cromo non temprabili)	M1.1 Acciaio inossidabile ferritico con durezza < 160 HB	1.22	AISI 5429, EN X7Cr14, DIN 1.4001, SS 2326, BS 434517, UNE F.3401, AFNOR Z8C12, GOST 08Ch13, UNI X6CrTi12
		M1.2 Acciaio inossidabile ferritico con durezza 160 – 220 HB	1.03	AISI 446, EN X10CrAl24, DIN 1.4762, SS 2322, ČSN 17113, BS 430517, UNE F.3154, GB 10Cr17, AFNOR Z10CA524, GOST 12Ch17, UNI X16Cr26
		M2.1 Acciaio inossidabile martensitico con durezza < 200 HB	1.08	AISI 430F, EN X14CrMo517, DIN 1.4104, SS 2383, ČSN 17140, BS 410521, UNE F.3117, AFNOR Z10CF17, UNI X10Cr517
	M2 Acciaio inossidabile martensitico (leghe normali al cromo non temprabili)	M2.2 Acciaio inossidabile martensitico con durezza 200 – 280 HB	0.89	AISI 440C, EN X105CrMo17, DIN 1.4125, SS 2385, ČSN 17023, BS 425C11, UNE F.3402, GB 102Cr17Mo, AFNOR Z100CD17, GOST 95Ch18, UNI GX6CrNi 13 04
		M2.3 Acciaio inossidabile martensitico con durezza 280 – 380 HB	0.75	AISI 420, EN X45Cr13, DIN 1.4034, ČSN 17029, BS 425C11, UNE F.3405, AFNOR Z44C14, GOST 20X17H12, UNI X30Cr13
		M3.1 Acciaio inossidabile austenitico con durezza < 200 HB	1.00	AISI 304, EN X5CrNi18-12, DIN 1.4303, SS 2352, ČSN 17249, BS 305517, UNE F.3513, GB 10Cr18Ni12, AFNOR Z8CN18.12, UNI X7CrNi18 10
	M3 Acciaio inossidabile austenitico (leghe di cromo-nichel e cromo-nichel-manganese)	M3.2 Acciaio inossidabile austenitico con durezza 200 – 260 HB	0.86	AISI 309, EN X15CrNiSi20-12, DIN 1.4828, ČSN 17251, BS 309S24, UNE F.3312, GB 1G23Ni13, AFNOR Z15CNS20.12, GOST 20Ch20Ni452, UNI 16CrNi23 14
		M3.3 Acciaio inossidabile austenitico con durezza 260 – 300 HB	0.77	AISI 5848, EN X45CrNiW18-9, DIN 1.4873, BS 331540, UNE F.3211, AFNOR Z35CNW514-4, UNI X45CrNiW 18 9
		M4 Acciaio inossidabile super-austenitico, duplex o indurito per precipitazione (leghe austenitiche con > 20 % Ni, microstruttura austenitica-ferritica o indurite per precipitazione)	M4.1 Acciaio inossidabile, austenitico-ferritico o super-austenitico con durezza < 300 HB	0.75
	M4.2 Acciaio inossidabile austenitico indurito per precipitazione con durezza 300 – 380 HB		0.64	AISI 631 (17-7PH), EN X7CrNiAl17-7, DIN 1.4568, SS 2388, ČSN 17465, BS 301513, UNE F.3217, GB 07Cr17Ni7Al, AFNOR Z9CNAl17-07, GOST 09Ch17N7Jut, UNI X53CrMnNi21 9

GRUPPO DEI MATERIALI LAVORATI (WMG)

Gruppo ISO	Sottogruppo	WMG (Gruppo dei materiali lavorati)	k _{9c}	Esempi di materiali (AISI, EN, DIN, ČSN, GB, SS, STN, BS, UNE, AFNOR, ASTM, GOST, UNS, UNI, ...)
K Ghisa (fusioni di leghe di ferro e carbonio con contenuto di carbonio > 2 %)	K1 Ghisa grigia (GG) (fusioni di ferro-carbonio con microstruttura in grafite lamellare)	K1.1 Ghisa grigia, ferritica o ferritica-perlitica con durezza < 180 HB	1.35	ASTM A48 Grade 20 (F11401), EN-JL-100, DIN GG-10 (0.6010), SS 0110, STN 422410, BS Grade 150, UNE FG10, GB HAT 100, AFNOR F410D, GOST SC 10, UNI G10
		K1.2 Ghisa grigia, ferritica-perlitica o perlitica con durezza 180 – 240 HB	1.00	ASTM A48 Grade 30 (F12101), EN-JL-1030, DIN GG-20 (0.6020), SS 0120, STN 422420, BS Grade 220, UNE FG20, GB HT200, AFNOR F220D, GOST Ч420, UNI G20
		K1.3 Ghisa grigia perlitica con durezza 180 – 240 HB	0.75	ASTM A48 Grade 50 (F13501), EN-JL-1060, DIN GG-35 (0.6035), SS 0135, STN 422435, BS Grade 350, UNE FG35, GB HAT300, AFNOR F350D, GOST SC35, UNI G35
	K2 Ghisa malleabile (GTS/GTW) (fusioni di ferro-carbonio trattate termicamente con microstruttura priva di grafite)	K2.1 Ghisa malleabile ferritica con durezza < 160 HB	1.39	ASTM A602 Grade M3210 (F20000), EN-JM-1130, DIN GTS-35 (0.8135), SS 0815, BS B340/12, UNE Type A, AFNOR MN 35-10, GOST K435-10
		K2.2 Ghisa malleabile, ferritica o perlitica con durezza 160 – 200 HB	1.13	ASTM A602 Grade M4504 (F20001), EN-JM-1040, DIN GTS-50-05 (0.8045), BS P50-05, AFNOR MB 45-7
		K2.3 Ghisa malleabile perlitica con durezza 200 – 240 HB	0.90	ASTM A602 Grade M7002 (F20004), EN-JM-1140, DIN GTS-45 (0.8145), SS 0854, STN 422540, BS P 45-06, UNE Typ B, AFNOR MP 50-5, GOST K445-7, UNI GMM 45
	K3 Ghisa duttile (GGG) (fusioni di ferro-carbonio con microstruttura in grafite nodulare)	K3.1 Ghisa duttile (nodulare/sferoidale) ferritica con durezza < 180 HB	1.23	ASTM A536 Grade 60-40-18 (F32800), EN-JS-1030, DIN GGG-40 (0.7040), SS 0717, STN 422304, BS 420/12, UNE FGE 42-12, GB QT 400, AFNOR FGS 400-12, GOST B440
		K3.2 Ghisa duttile (nodulare/sferoidale), ferritica o perlitica con durezza 180 – 220 HB	0.94	ASTM A536 Grade 80-55-06 (F33800), EN-JS-1050, DIN GGG-50 (0.7050), SS 0727, STN 422305, BS 500/7, UNE FGE 50-7, GB QT 500-7, AFNOR FGS 500-7, GOST B450
		K3.3 Ghisa duttile (nodulare/sferoidale) perlitica con durezza 220 – 260 HB	0.76	ASTM A536 Grade 100-70-03 (F34800), EN-JS-1060, DIN GGG-60 (0.7060), SS 0732, STN 422306, BS 600/3, UNE FG70-2, GB QT 600-3, AFNOR FGS 600-3, GOST B460
	K4 Ghisa duttile austenitica o austemperata (Ni-Resist/ADI) (fusioni in lega di ferro-carbonio con microstruttura austenitica o ausferritica)	K4.1 Ghisa austenitica con durezza < 180 HB	1.14	ASTM A436 Type 1 (L-NiCuCr 15 6 2, F41000), EN-JL-3011, DIN GGL-NiMn 13 7 (0.6652), SS 0523, BS Grade F1, AFNOR FGL-Ni13Mn7, GOST S-NiMn 13 7
		K4.2 Ghisa austenitica con durezza 180 – 240 HB	0.86	ASTM A439 Type D-2B (S-NiCr 20 3, F43001), EN-JS-3021, DIN GGG-NiMn 23 4, SS 0776, BS Grade S2M, AFNOR FGS Ni23 Mn4, GOST ЧН19Х3U
		K4.3 Ghisa duttile austemperata con durezza 240 – 280 HB	0.63	ASTM A897 Grade 110-70-11
	K5 Ghisa a grafite compattata (GGI) (fusioni di ferro-carbonio con struttura a grafite vermicolare)	K4.4 Ghisa duttile austemperata con durezza 280 – 320 HB	0.54	ASTM A897 Grade 125-80-10, EN-JS-1100, DIN GGG-90 (5.3400)
		K4.5 Ghisa duttile austemperata con durezza 320 – 360 HB	0.45	ASTM A897 Grade 2 (150-110-07), EN-JS-1110, DIN GGG-100 (5.3403)
	K5 Ghisa a grafite compattata (GGI) (fusioni di ferro-carbonio con struttura a grafite vermicolare)	K5.1 Ghisa vermicolare a grafite compattata con durezza < 180 HB	1.29	ASTM A842 Grade 300, EN-GJV-300, DIN GGV 30, GOST ЧBT30,
K5.2 Ghisa vermicolare a grafite compattata con durezza 180 – 220 HB		0.97	ASTM A842 Grade 350, EN-GJV-350, DIN GGV 35 (5.2200), GOST ЧBT30,	
K5.3 Ghisa vermicolare a grafite compattata con durezza 220 – 260 HB		0.75	ASTM A842 Grade 450, EN-GJV-450, DIN GGV 45, GOST ЧBT45,	

GRUPPO DEI MATERIALI LAVORATI (WMG)

Gruppo ISO	Sottogruppo	WMG (Gruppo dei materiali lavorati)	k _{vg}	Esempi di materiali (AISI, EN, DIN, ČSN, GB, SS, STN, BS, UNE, AFNOR, ASTM, GOST, UNS, UNI, ...)
N Metalli non ferrosi (metalli, comprese leghe, senza una quantità apprezzabile di ferro)	N1 Alluminio semilavorato	N1.1 Alluminio puro e leghe a base di alluminio con durezza < 60 HB	1.33	UNS A91200, EN AL99.6, DIN 3.0205, SS 4010, STN 424009, BS 1C, UNE L-3001, GB L5, AFNOR A4, GOST ADC, UNI 3567
		N1.2 Leghe a base di alluminio con durezza 60 – 100 HB	1.00	UNS A93004, EN AlMn0.5Mg0.5, DIN 3.0505, SS 4054, STN 424432, BS N31, UNE L-3831, GB LF2, AFNOR A-M1, GOST AMu, UNI 3568
		N1.3 Leghe a base di alluminio con durezza 100 – 150 HB	0.67	UNS A95083, EN AlMg4.5Mn0.7, DIN 3.3547, SS 4140, STN 424415, BS N8, UNE L-3321, GB AlMg4.5Mn, AFNOR A-G4.5Mn, GOST Amg 4.5, UNI P-AlMg4.4
	N2 Alluminio pressofuso	N2.1 Leghe di alluminio pressofuso con durezza < 75 HB	0.67	UNS A02080, EN AlCu45, BS LM11, STN 424331, UNE AlSi1Cu, GOST AMg5K, UNI G-AlSi7Mg
		N2.2 Leghe di alluminio pressofuso con durezza 75 – 90 HB	0.60	UNS A02420, EN AlCu4Ni2Mg2, SS AlSi7MgFe, BS LM6, STN 424519, UNE Al-7SiMg, AFNOR A-S7G, GOST AK7, UNI G-AlSi7Mg
		N2.3 Leghe di alluminio pressofuso con durezza 90 – 140 HB	0.43	UNS A03360, EN G-ALCu4NiMg2, SS AlSi10Mg, STN 424336, BS LM 30, AFNOR A-S10G, UNI G-AlSi9Mg
	N3 Rame o leghe di rame	N3.1 Materiali in leghe di rame a taglio libero con eccellenti proprietà di lavorazione	0.70	UNS C14700, EN CuPb1P, DIN 2.1498, STN 423214, BS C111, AFNOR CuZn35Pb2, GOST L63-3, UNI CuS(P0.01)
		N3.2 Leghe di rame a truciolo corto con lavorabilità da buona a moderata	0.41	UNS C81540, EN CuNi25Cr, DIN 2.0857, STN 423220, BS NS113, UNE CuSn12, AFNOR CuZn40, GOST L60, UNI P-CuZn-40
		N3.3 Rame elettrolitico e leghe di rame a truciolo lungo con lavorabilità da moderata a scarsa	0.21	UNS C10100, EN CuAg0.1, DIN 2.1203, SS 5010, UNE CUSi3Mn1, AFNOR Cu-C2, GOST M1f, UNI Cu-0F
	N4 Polimeri (materiali sintetici o semisintetici)	N4.1 Polimeri termoplastici	0.70	ABS, Acryl, Duraplant, Elastomer, EP, Epoxid, FEP, Fluor, Gummi, Kautschuk, Latex, ME, MPF, PA, PAI, PC, PE, PEEK, PEI, PES, PET, PF, Phenolharze, PI, PMMA, Polyamide, Polyester, Polyolefine, Polysulfon, POM, PP, PPE, PPS, PS, PSU, PTFE, PU, PUR, PVDF, SAN, SI, Styrol, UF, Ureol
		N4.2 Polimeri termoindurenti	0.27	Aramid, Epoxy, Fluoropolymer, Meacrylate, Melamine, Phenolic, Polyester, Polyimide, Polymethacrylimide, Polyurethane
		N4.3 Polimeri rinforzati o compositi	0.29	CFK, GFK, GMT, Honeycomb, Kevlar, LFT, Organo, SMC
	N5 Grafite	N5.1	1.0	CGM-1, CM-00, GM-10, GM-11, GR030, GR030PI, GR060, GR060PI, GR125, MC-01, MC-01R0, MC-03, MC-03M, IG11, IG-15, IG-32, IG-43, IG-45, IG-70, ISEM-1, ISEM-2, ISEM-3, R8340, R8500X, Technograph 15, Technograph 30, ISO-63, EDM C-3, EDM1, EDM3, ISO-90, ISO-93, ISO-95, R8510, R8650,

GRUPPO DEI MATERIALI LAVORATI (WMG)







Gruppo ISO	Sottogruppo	WMG (Gruppo dei materiali lavorati)	k_{ve}	Esempi di materiali (AISI, EN, DIN, ČSN, GB, SS, STN, BS, UNE, AFNOR, ASTM, GOST, UNS, UNI, ...)
<p>S</p> <p>Leghe per alte temperature (superleghe con resistenza alle alte temperature e resistenza alla corrosione superiore rispetto all'acciaio inossidabile)</p>		<p>S1.1 Titanio o leghe di titanio pressofuso con durezza < 200 HB</p>	1.94	<p>UNS R50250 (Grade 1), EN Ti 99.6, DIN 3.7035, BS TA.2, UNE Ti-Po2, AFNOR T-40, GOST BT1-00, AISI R50250, 3.7025, T35, 2TA1, R50400, 3.7035, 2TAZ,</p>
	S1	<p>S1.2 Titanio o leghe di titanio con durezza 200 – 280 HB</p>	1.72	<p>UNS R56404 (Grade 29), EN Ti2Cu, DIN 3.7124, BS TA.21, UNE Ti-P11, AFNOR T-U2, AISI TA6V, Ti-6Al-4V, Ti 10.2.3, Ti5553</p>
		<p>S1.3 Leghe di titanio con durezza 280 – 360 HB</p>	1.44	<p>UNS R54250 (Grade 38), EN TiAl6V4, DIN 3.7165, ČSN TiAl6VELI, BS TA. 13, UNE Ti-P63, AFNOR T-A6V, GOST BT6, AISI TA6V, Ti-6Al-4V, Ti 10.2.3, Ti5553</p>
		<p>S2.1 Leghe a base di Fe resistenti al calore con durezza < 200 HB</p>	1.33	<p>UNS N08801 (Incoloy 801), EN X8 NiCrAlTi31-21, DIN 1.4959, BS NA 15, AFNOR Z8NC33-21, AISI A-286, Discaloy, Haynes 556, Inconel 909, Greek Ascology</p>
	S2	<p>S2.2 Leghe a base di Fe resistenti al calore con durezza 200 – 280 HB</p>	1.17	<p>UNS N19907, EN X6NiCrTiMoVB25-15-2, DIN 1.4980, SS 2570, BS HR52, AFNOR Z6NCTDV25.15B, GOST 36HXT10, AISI A-286, Discaloy, Haynes 556, Inconel 909, Greek Ascology</p>
		<p>S3.1 Leghe a base di Ni resistenti al calore con durezza < 200 HB</p>	1.00	<p>UNS A09706 (Inconel 706), EN NiCr25FeAl, DIN 2.4856, BS HR 6, ČSN Inconel 625, UNE F.3313, GB 1Cr16Ni35, AFNOR NC22FeDNB, GOST XH38BT, AISI Inconel 718, 706 Waspalloy, Udimet 720, Inconel 625</p>
	S3	<p>S3.2 Leghe a base di Ni resistenti al calore con durezza 280 – 360 HB</p>	0.83	<p>UNS N07001, EN NiCr20Co13Mo4Ti3Al, DIN 2.4654, BS HR 2, ČSN Waspalloy, AFNOR NCKD 20ATV, GOST XH80T5K0, AISI Inconel 718, 706 Waspalloy, Udimet 720, Inconel 625</p>
		<p>S4.1 Leghe a base di Co resistenti al calore con durezza < 240 HB</p>	0.78	<p>UNS R30016 (Stellite 6b), EN CoCr20W15Ni, DIN 2.4964, AFNOR KC 20 WN, GOST ЛК52, AISI Haynes 25, Stellite 21, 31</p>
	S4	<p>S4.2 Leghe a base di Co resistenti al calore con durezza 240 – 320 HB</p>	0.67	<p>UNS R30016 (Stellite 6b), EN CoCr20W15Ni, DIN 2.4964, AFNOR KC 20 WN, GOST ЛК52, AISI Haynes 25, Stellite 21, 31</p>

GRUPPO DEI MATERIALI LAVORATI (WMG)

Gruppo ISO	Sottogruppo	WMG (Gruppo dei materiali lavorati)	k_{vg}	Esempi di materiali (AISI, EN, DIN, ČSN, GB, SS, STN, BS, UNE, AFNOR, ASTM, GOST, UNS, UNI, ...)
H Materiali temprati (qualsiasi metallo prodotto con durezza > 45 HRC)	H1 Ghisa in conchiglia	H1.1 Ghisa in conchiglia con durezza < 440 HB	1.52	UNS F45001, EN-GJS-1050-6, DIN 5.3406, SS 0512, BS Grade 2A
	H2 Ghisa temprata	H2.1 Ghisa temprata con durezza < 55 HRC	0.90	UNS F45003, EN-GJS-1400-1, DIN 5.3405, SS 0457, BS Grade 3D
		H2.2 Ghisa temprata con durezza > 55 HRC	0.77	UNS F45003, EN-GX260NiCr4-2, DIN 0.9620, SS 0466, BS Grade S
	H3 Acciaio temprato < 55 HRC	H3.1 Acciaio temprato con durezza < 51 HRC	1.00	AISI 4135, EN 34CrMo4, DIN 1.7220, SS 2234, STN 415131, BS 198, UNE F.1250, GB 35CrMo, AFNOR 35CD4, GOST AC38XTM, UNI 35CrMo4KB
		H3.2 Acciaio temprato con durezza 51 – 55 HRC	0.82	AISI 4135, EN 34CrMo4, DIN 1.7220, SS 2234, STN 415131, BS 198, UNE F.1250, GB 35CrMo, AFNOR 35CD4, GOST AC38XTM, UNI 35CrMo4KB
	H4 Acciaio temprato > 55 HRC	H4.1 Acciaio temprato con durezza 55 – 59 HRC	0.64	UNS T31501, EN 100MnCrW4, DIN 1.2510, SS 2140, STN 419413, BS B01, UNE F.5220, GB 9CrWMn, AFNOR 90MnWCrV5, GOST 9XBТ, UNI 95MnWCr5KU
		H4.2 Acciaio temprato con durezza > 59 HRC	0.54	UNS T31501, EN 100MnCrW4, DIN 1.2510, SS 2140, STN 419413, BS B01, UNE F.5220, GB 9CrWMn, AFNOR 90MnWCrV5, GOST 9XBТ, UNI 95MnWCr5KU

FATTORI DI CORREZIONE

Fattori di correzione per tipo specifico di operazione C_{VCO}

 	 0.5			 1.5			 2.5			 5.0			 12.0		
	I	II	III	I	II	III	I	II	III	I	II	III	I	II	III
	0.05	0.08	0.10	0.10	0.15	0.20	0.20	0.30	0.40	0.40	0.60	0.80	0.80	1.00	1.30
Rompitruolo per finitura (FF, FF2...)	1.15	1.00	0.95	0.85	0.80	–	–	–	–	–	–	–	–	–	–
Rompitruolo per finitura (NF, SF.)	–	–	1.20	1.05	1.00	1.05	1.00	0.90	–	–	–	–	–	–	–
Rompitruolo per lavorazione media (FM, M, NM, NMR, SM...)	–	–	–	–	–	1.15	1.10	1.00	0.95	0.85	–	–	–	–	–
Rompitruolo per sgrossatura (RM, NRM, NR, R...)	–	–	–	–	–	–	–	–	1.25	1.10	1.00	0.95	0.65	–	–
Rompitruolo per sgrossatura pesante (HR, HR2, NR2, OR...) per una durata di 45 min	–	–	–	–	–	–	–	–	–	1.25	1.20	1.15	1.05	1.00	0.95

Fattori di correzione per durabilità richiesta C_{VCT}

	minuti	10	15	20	30	45	60
Operazioni di lavorazione generica (da finitura fine a sgrossatura)		1.13	1.00	0.93	0.84	0.76	0.71
Operazioni di lavorazione pesante (sgrossatura pesante)		–	–	–	1.10	1.00	0.93

Fattori di correzione aggiuntivi C_{VCA}

Ambiente di lavorazione	C_{VCA}
Condizione del materiale da lavorare (crosta dura dovuta a forgiatura o fusione)	0.70
Tornitura interna	0.75
Troncatura e scanalatura (radiale)	0.88
Scanalatura frontale	0.80
Taglio interrotto	0.80
Condizioni di lavorazione instabili	0.85
Condizioni di lavorazione comuni	1.00
Condizioni di lavorazione stabili	1.20

Velocità di taglio corretta risultante v_{cC}

$$v_{cC} = v_c \cdot k_{vG} \cdot C_{VCO} \cdot C_{VCT} \cdot C_{VCA}$$

k_{vG} – coefficiente del materiale usato

v_c – velocità iniziale dalla pagina del catalogo

PARTI dell'inserto

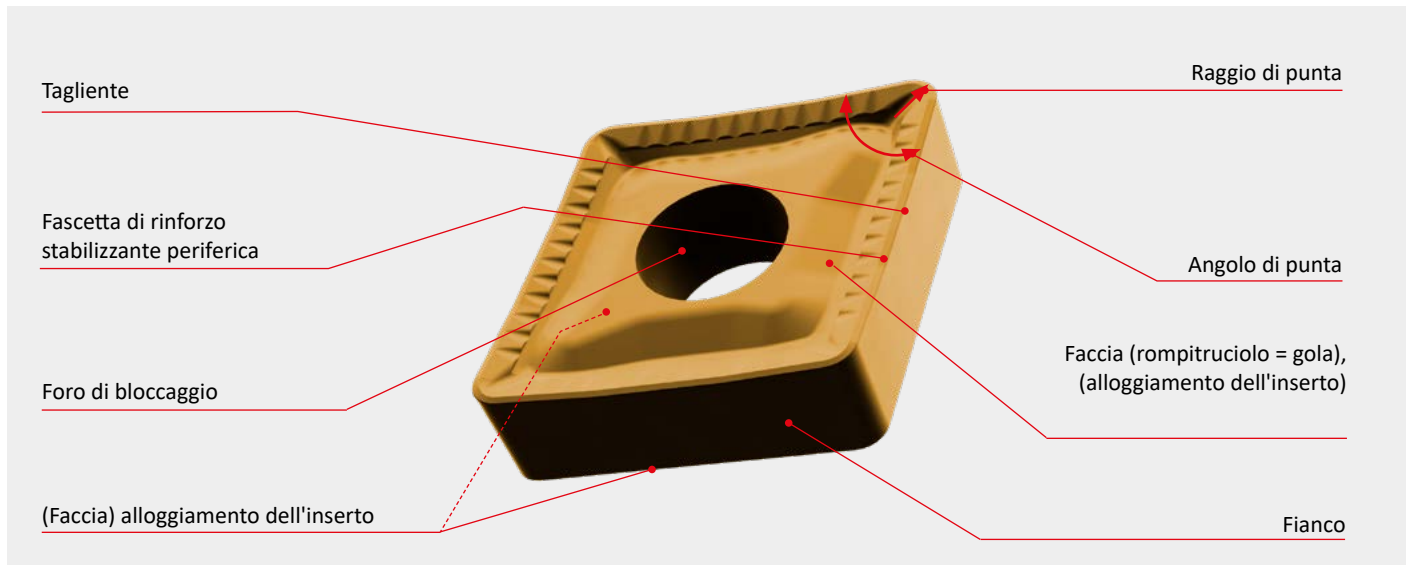

Raggio di punta – nella maggior parte dei casi determina la profondità di taglio minima raccomandata e, insieme all'avanzamento, determina anche la rugosità ottenuta.

Il **Tagliante** rappresenta l'intersezione tra le superfici della faccia e del fianco. La sua rugosità longitudinale è uno dei primi criteri di valutazione nella scelta di un inserto.

L'**angolo di punta dell'inserto** è molto importante per quanto riguarda la lunghezza utile del tagliante, la resistenza nel taglio interrotto, la diffusione del calore dal punto di taglio. ecc.

La **fascetta di rinforzo stabilizzante periferica** è un'area situata dopo il tagliante. La sua larghezza è molto spesso variabile e anche il suo angolo cambia regolarmente. Nella maggior parte dei casi, la larghezza della fascetta di rinforzo, insieme all'angolo di regolazione a cui lavora l'inserto, è un fattore limitante per specificare l'avanzamento minimo.

Il **rompitruciolo** – insieme alla fascetta di rinforzo determina il campo di applicazione (gole strette – finitura e materiali con truciolo corto, gole larghe – per lo più operazioni di sgrossatura e materiali tenaci).

Il **foro di bloccaggio** – se non è presente il foro, l'inserto sarà sicuramente progettato per il sistema di bloccaggio ISO C. Se il foro è cilindrico, l'inserto è progettato per i sistemi di bloccaggio ISO P, M, D + (in quasi tutti i casi l'angolo sul fianco è 0°. Se il foro è svasato e l'angolo sul fianco è positivo, l'inserto è monolaterale ed è progettato per il sistema di bloccaggio ISO S. Se il foro è conico ed è identico su entrambi i lati dell'inserto, è molto probabile che si tratti di un inserto tangenziale (bilaterale).

L'**alloggiamento dell'inserto** – se è formato dallo stesso rilievo della superficie della faccia l'inserto è bilaterale, se è piatto l'inserto è monolaterale. Deve essere valutato in relazione al carico previsto o al tipo di taglio. (la dimensione e la distanza del raggio e dei taglianti).

Parti del portainsero

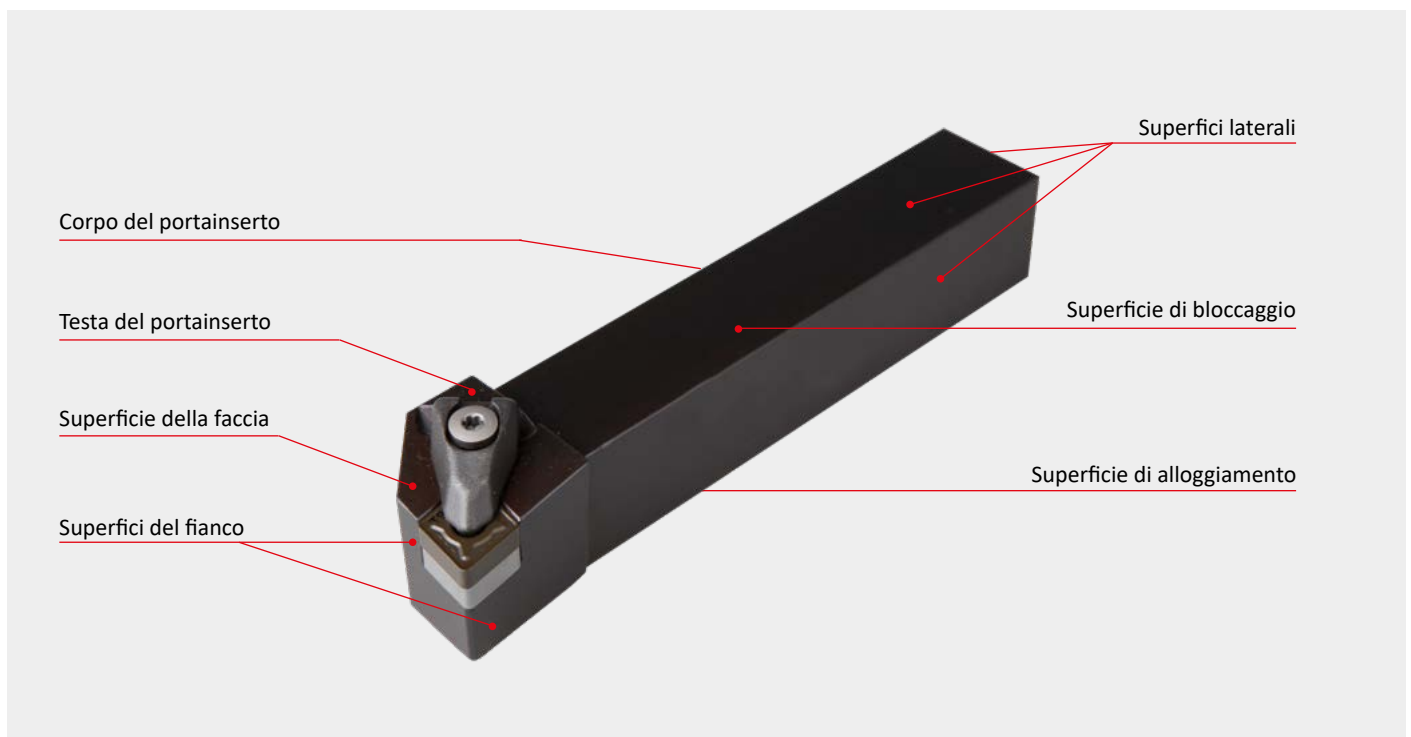

L'utensile per tornitura è costituito da due parti fondamentali:

1) il corpo composto da:

- superficie di alloggiamento
- superficie di bloccaggio
- superfici laterali (che possono essere dotate anche di viti di regolazione)

Nota: Per la tornitura esterna, il corpo del portainserito è solitamente una sezione trasversale quadra (quadrata o rettangolo). Per la tornitura interna, la sezione trasversale del corpo del supporto è circolare e, per sezioni trasversali maggiori, è provvista di superfici di regolazione. Ma il corpo del supporto può essere formato anche da un tipo speciale di stelo, come PSC o HSK

2) la testa con:

- faccia
- superfici del fianco

La testa del portainserito include anche un sistema di bloccaggio ed una sede in cui vengono inseriti gli inserti

Dal lato della faccia (per inserti radiali) o dal lato della superficie del fianco (per inserti tangenziali)

Nota: le teste sono di tipo:

- dritto – consente la tornitura in entrambe le direzioni
- laterale – permette di differenziare tra design destro e sinistro
- piegato – permette di differenziare tra design destro e sinistro (consente un miglior accesso nel tornire superfici più complesse)

Angoli di lavorazione e costruttivi degli utensili per tornitura

La posizione e l'orientamento del tagliente rispetto al pezzo da lavorare e la sua forma geometrica determinano le caratteristiche dell'angolo di taglio.

Gli angoli sul tagliente sono determinati da un sistema a due coordinate:

- a) design
- b) lavorazione

a) sistema di coordinate dell'utensile (stazionario), utilizzato per determinare la geometria del tagliente durante la progettazione, la produzione e il controllo. Tutti gli angoli definiti in questo sistema sono chiamati angoli di taglio dell'utensile. Tutti gli angoli definiti dagli standard ISO in base alla forma dell'inserto appartengono a questo gruppo.

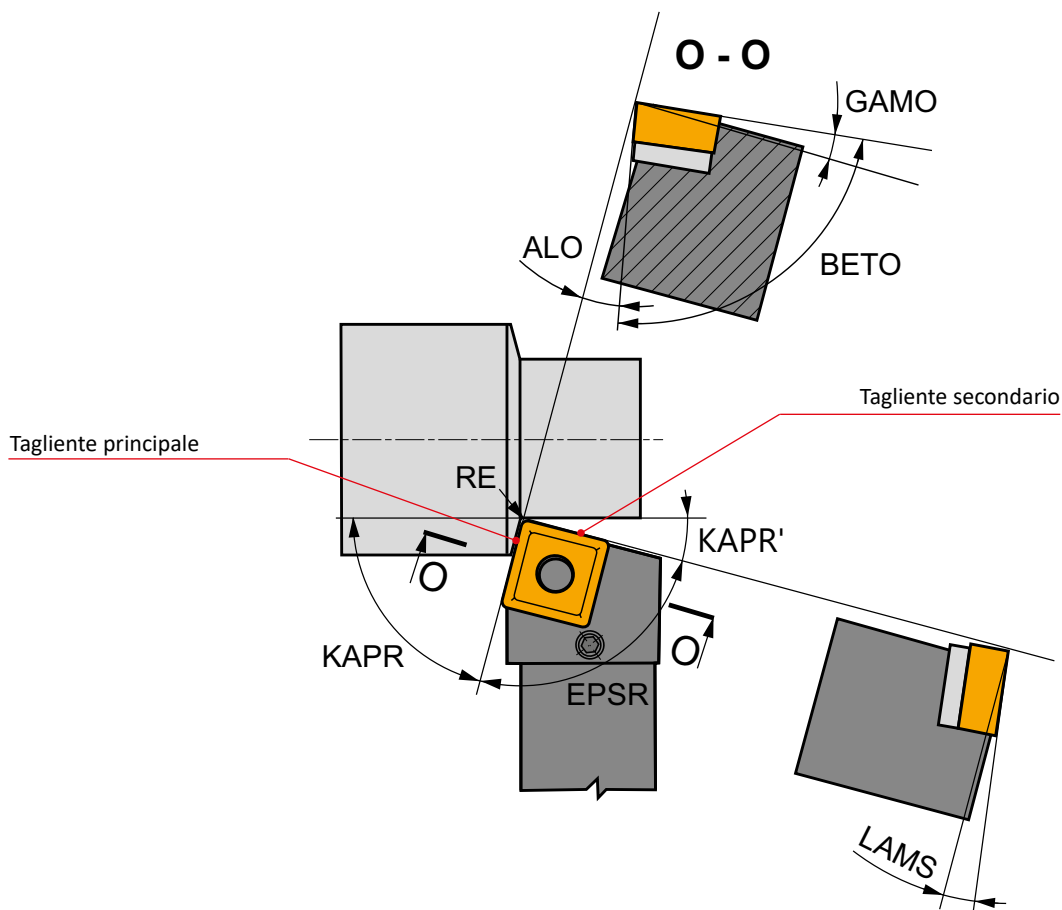

DEFINIZIONE DEI TERMINI DI BASE

b) sistema di coordinate di lavorazione, utilizzato per determinare la geometria del tagliente durante il processo di lavorazione. Questi angoli sono chiamati angoli di lavoro e dipendono dalla posizione dell'inserto bloccato nel portainserito. Ad esempio, l'inserto d SNUN ha un angolo di inclinazione utensile $AN = 0^\circ$ e un angolo di spoglia $GAMP = 0^\circ$, tuttavia l'inserto è bloccato nel portainserito per dare un angolo di spoglia inferiore ortogonale $ALO = 6^\circ$ e un angolo di spoglia superiore ortogonale $GAMO = -6^\circ$. Gli angoli di lavorazione influenzano gli angoli dell'utensile con rompitruccioli preformati. Tuttavia, i più importanti sono gli angoli di lavorazione per il processo di taglio.

Nell'immagine, gli angoli base dell'utensile sono indicati nel piano utensile base (interposto dalla superficie d'appoggio del portainserito) e nel piano utensile normale (interposto attraverso il tagliente – sezione O-O).

Ci occupiamo dei seguenti angoli:

L'angolo di spoglia superiore ortogonale $GAMO$ – influenza sostanzialmente il processo di taglio. La sua dimensione determina l'andamento e l'intensità della deformazione plastica durante la formazione del truciolo; determina anche il valore delle forze di taglio e lo stress termico sul tagliente. L'intervallo degli angoli di spoglia è ampio, da $GAMO = +25^\circ$ a -15° per utensili con inserti a fissaggio meccanico per fresatura e tornitura. Un angolo di spoglia positivo migliora le condizioni di formazione del truciolo, riduce le forze di taglio e riduce il livello di temperatura di taglio. Un angolo di spoglia negativo migliora la resistenza del tagliente, tuttavia aumenta la deformazione plastica durante la formazione del truciolo e quindi anche le forze di taglio e le temperature.

L'angolo di spoglia inferiore ortogonale ALO influenza il valore di attrito tra il fianco e la superficie lavorata. Aumentando l'angolo ALO si riduce questo attrito e quindi anche l'usura sul fianco.

L'angolo del cuneo $BETO$ è l'angolo dello spigolo dell'inserto dell'inserto da taglio. Aumentando l'angolo $BETO$ aumenta la robustezza del tagliente (resistenza agli urti), ma aumenta anche la resistenza al taglio.

Angolo di inclinazione del tagliente principale $LAMS$ – determina il punto di primo contatto tra il tagliente e il pezzo da lavorare, cosa importante per il taglio interrotto. Se il $LAMS$ è positivo, il punto di contatto è vicino alla punta dell'inserto da taglio. L'angolo negativo $LAMS$ allontana il punto di primo contatto dalla punta e quindi influisce sulla resistenza del tagliente alle sollecitazioni meccaniche. Inoltre, il $LAMS$ influisce sulla direzione di evacuazione del truciolo. Se il $LAMS$ è negativo, la direzione di evacuazione del truciolo è verso la superficie lavorata. Mentre se il $LAMS$ è positivo, la direzione di evacuazione del truciolo si allontana dalla superficie lavorata.

L'angolo del tagliente dell'utensile $KAPR$ influisce in modo predominante sui valori delle forze di taglio e sulla forma della sezione trasversale del truciolo. La riduzione dell'angolo $KAPR$ rende il truciolo più sottile a un dato avanzamento f e profondità di taglio a_p . Mentre se $KAPR = 90^\circ$ lo spessore del truciolo $h = f$ e la larghezza del truciolo $b = a_p$ aumentano. Per quanto riguarda l'angolo $KAPR$ decrescente, la larghezza funzionale del rinforzo del tagliente aumenta e l'angolo di spoglia dell'inserto diminuisce.

L'angolo registrabile del tagliente secondario $KAPR'$ insieme al raggio di punta RE definiscono la qualità finale della superficie.

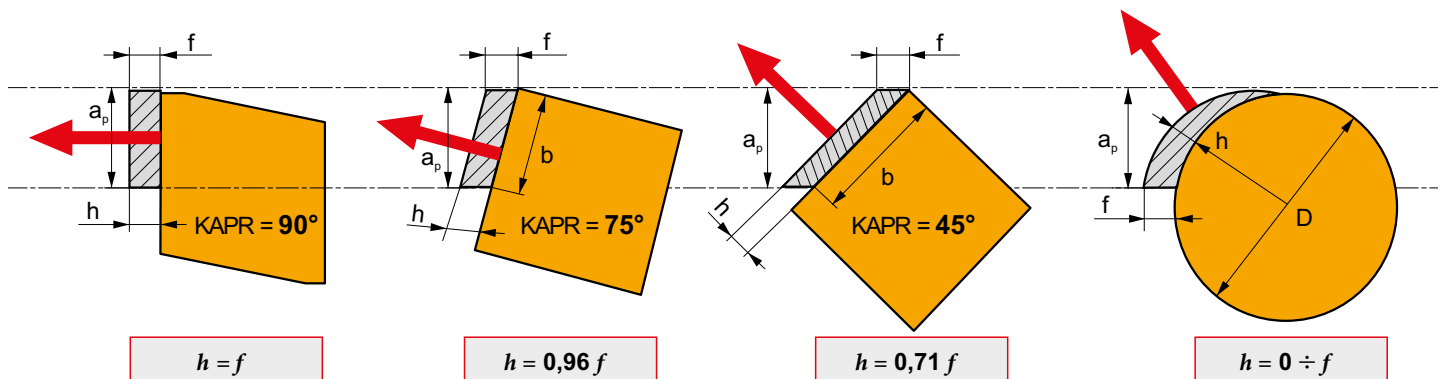

DEFINIZIONE DEI TERMINI DI BASE

Effetto della geometria dell'utensile di lavorazione

Parametro	Modifica	Abrasiono del fianco	Formazione di craterizzazione	Tendenza a deformazione plastica	Resistenza a condizioni di lavoro avverse	Superficie	Forze di taglio	Tendenza a vibrare	Temperatura fluido di taglio	Formazione del truciolo
Angolo tagliente principale	Minore o maggiore di 90°	Leggermente ridotta	Leggermente ridotta	Leggermente ridotta	Leggermente aumentata	Effetto non dimostrato	Leggermente aumentate	Aumentata	Minore	Il chip è più sottile e più largo (modifiche b/h)
Angolo del tagliente secondario	Diminuito	Leggermente ridotta	Effetto non dimostrato	Leggermente aumentata	Molto leggermente aumentata	Migliorata (condizionale)	Leggermente aumentate	Aumentata	Aumentata molto leggermente	Effetto insignificante
Angolo di punta	Aumentato	Effetto non dimostrato	Effetto non dimostrato	Ridotta	Migliorata	Effetto non dimostrato (-)	Effetto non dimostrato (-)	Leggermente aumentata	Aumentata molto leggermente	Effetto insignificante
Raggio di punta	Aumentato	Ridotta (a un certo livello)	Ridotta (a un certo livello)	Ridotta	Migliorata	Migliorata (condizionale)	Aumentate (a un certo livello)	Aumentata	Leggermente aumentata	Formazione più morbida (principalmente basata sul romptruciolo)
Angolo sul fianco	Più positivo	Ridotta	Effetto non dimostrato	Ridotta molto leggermente	Leggermente peggio	Migliorata (condizionale)	Leggermente ridotte	Leggermente ridotta	Leggermente inferiore	Effetto non dimostrato
Angolo faccia	Più positivo	Ridotta molto leggermente	Ridotta	Leggermente ridotta	Leggermente peggio	Effetto non dimostrato (+)	Leggermente ridotte	Ridotta	Minore	Il truciolo è meno compresso, ma viene forzato più vicino al tagliente
Angolo del tagliente	Positivo	Effetto non dimostrato	Leggermente ridotta	Leggermente ridotta	Leggermente peggio	Effetto non dimostrato (+)	Leggermente ridotte	Leggermente ridotta	Leggermente inferiore	Deviazione del truciolo dal pezzo da lavorare
Larghezza rinforzo del tagliente	Più larga	Leggermente aumentata	Leggermente aumentata	Leggermente aumentata	Leggermente aumentata	Effetto non dimostrato (+)	Aumentate	Aumentata	Maggiore	Il truciolo è più compresso, ma preme su una superficie più larga
Angolo del rinforzo del tagliente (lavorazione)	Positivo	Ridotta molto leggermente	Leggermente ridotta	Leggermente ridotta	Leggermente peggio	Effetto non dimostrato (+)	Ridotte	Ridotta	Leggermente inferiore	Il truciolo è meno compresso

DEFINIZIONE DEI TERMINI DI BASE

Cosa influenza le forze di taglio e in che modo?

Condizioni	Acciaio al carbonio (HB230)	Acciaio inossidabile (HB145)	Ghisa grigia (HB130)
Velocità di taglio e forza di taglio $f = 0.2$ mm/giro $a_p = 2$ mm KAPR 90° RE 0.4	<p style="text-align: center;">Velocità di taglio: V_c (m/min)</p>	<p style="text-align: center;">Velocità di taglio: V_c (m/min)</p>	<p style="text-align: center;">Velocità di taglio: V_c (m/min)</p>
Profondità di taglio e forza di taglio $V_c = 100$ m/min $a_p = 0.2$ mm/giro KAPR 90° RE 0.4	<p style="text-align: center;">Profondità di taglio: a_p (mm)</p>	<p style="text-align: center;">Profondità di taglio: a_p (mm)</p>	<p style="text-align: center;">Profondità di taglio: a_p (mm)</p>
Velocità di avanzamento e forza di taglio $V_c = 100$ m/min $a_p = 2$ mm KAPR 90° RE 0.4	<p style="text-align: center;">Avanzamento: F (mm/giro)</p>	<p style="text-align: center;">Avanzamento: F (mm/giro)</p>	<p style="text-align: center;">Avanzamento: F (mm/giro)</p>
Raggio di punta e forza di taglio $V_c = 100$ m/min $f = 0.2$ mm/giro $a_p = 1.2$ mm KAPR 90°	<p style="text-align: center;">Raggio di punta: RE (mm)</p>	<p style="text-align: center;">Raggio di punta: RE (mm)</p>	<p style="text-align: center;">Raggio di punta: RE (mm)</p>
Angolo del tagliente utensile $V_c = 100$ m/min $f = 0.2$ mm/giro $a_p = 2$ mm KAPR $45^\circ, 60^\circ, 75^\circ, 90^\circ$ (valori sull'asse x) RE 0.4	<p style="text-align: center;">KAPR</p>	<p style="text-align: center;">KAPR</p>	<p style="text-align: center;">KAPR</p>
Angolo di spoglia e forza di taglio $V_c = 100$ m/min $f = 0.2$ mm/giro $a_p = 2$ mm KAPR 90° RE 0.4	<p style="text-align: center;">GAMO</p>	<p style="text-align: center;">GAMO</p>	<p style="text-align: center;">GAMO</p>

Scelta del portainserito per quanto riguarda la tecnica di bloccaggio

L'offerta di UTENSILI PRAMET comprende portainseriti, portautensili regolabili, teste modulari e portautensili regolabili per tornitura esterna longitudinale, sfacciatura, copiatura di tornitura e naturalmente anche per tornitura interna. I portainseriti vengono classificati in sei gruppi, a seconda del sistema di bloccaggio degli inserti, schematicamente illustrati nel seguente passaggio.

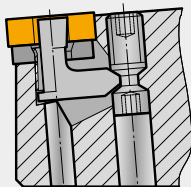

ISO P

Questo sistema serve per il bloccaggio di inserti negativi con foro cilindrico, sia con formatrucioli che senza. Il bloccaggio dell'inserto è ottenuto grazie ad una leva angolare che, dopo aver serrato la vite, preme l'inserto verso il basso nella sede. I portainseriti con questo sistema di bloccaggio garantiscono un fissaggio affidabile e preciso dell'inserto. Ottengono il massimo e anche il più frequente utilizzo nelle operazioni di tornitura esterna, ovvero sia di finitura che di sgrossatura. In alternativa, questo tipo di bloccaggio può essere utilizzato anche per portainseriti destinati alla tornitura interna di fori con diametri maggiori.

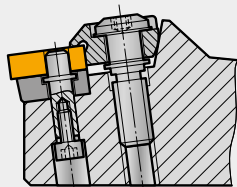

ISO M

Questo sistema viene utilizzato per il bloccaggio di inserti dello stesso tipo di quello del sistema ISO P. In questo caso un inserto viene posizionato su un robusto perno premuto da una staffa di bloccaggio che, al contempo, fissa anche la parte superiore dell'inserto. Questo sistema di bloccaggio è adatto principalmente per utensili con presunto carico dinamico maggiore. Questi portainseriti vengono utilizzati quasi esclusivamente per la tornitura esterna.

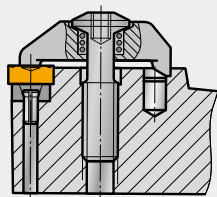

ISO C

Questo sistema serve per il bloccaggio di inserti sia negativi che positivi senza fori, ovvero sia con formatrucioli che senza. L'inserto viene fissato nella sede del portainserito da una staffa di bloccaggio a vite, sotto cui è incorporato un formatruciolo stampato lateralmente su alcuni tipi di inserto. I supporti con questo sistema di bloccaggio vengono utilizzati sia per la lavorazione di superficie esterna che per quella interna. Attualmente il sistema di bloccaggio C è meno utilizzato. Soprattutto negli utensili per tornitura interna viene proficuamente sostituito dal sistema S.

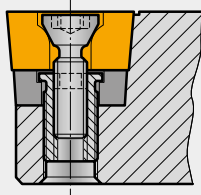

ISO S

Questo sistema di bloccaggio viene utilizzato principalmente per utensili di piccola sezione trasversale, progettati per tornitura sia esterna che interna. In questo caso una vite speciale, passando attraverso un foro svasato dell'inserto, realizza il bloccaggio. L'inserto viene fissato nella sede dell'utensile serrando questa vite. Questa soluzione è particolarmente conveniente perché non vi sono ostacoli al flusso dei trucioli.

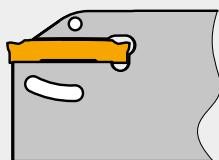

ISO X

Questa descrizione identifica gli utensili con il cosiddetto sistema di bloccaggio speciale (cioè diverso a seconda dei singoli produttori e fornitori di utensili). Nel nostro caso, sotto questa marcatura abbiamo identificato quei portainseriti che utilizzano la resistenza e l'elasticità dell'acciaio per bloccare l'inserto nella sede. Questo sistema di bloccaggio viene utilizzato per utensili destinati alla troncatura e all'esecuzione di scanalature a tuffo.

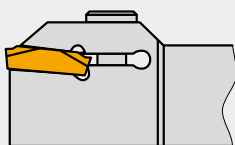

ISO G

Questo sistema di bloccaggio viene utilizzato sugli utensili per scanalatura e tornitura a copiare (sistema CTP). L'inserto viene spinto dall'alto nella sua sede da una staffa di bloccaggio. La superficie di contatto nella sede utensile, nella staffa di bloccaggio e anche nell'inserto è sagomata in modo tale da ostacolare lo spostamento dell'inserto a causa delle spinte in lavorazione.

SCelta DELL'UTENSILE

Con riferimento all'utensile a sezione rettangolare

Utensili da esterni (sezione quadra)

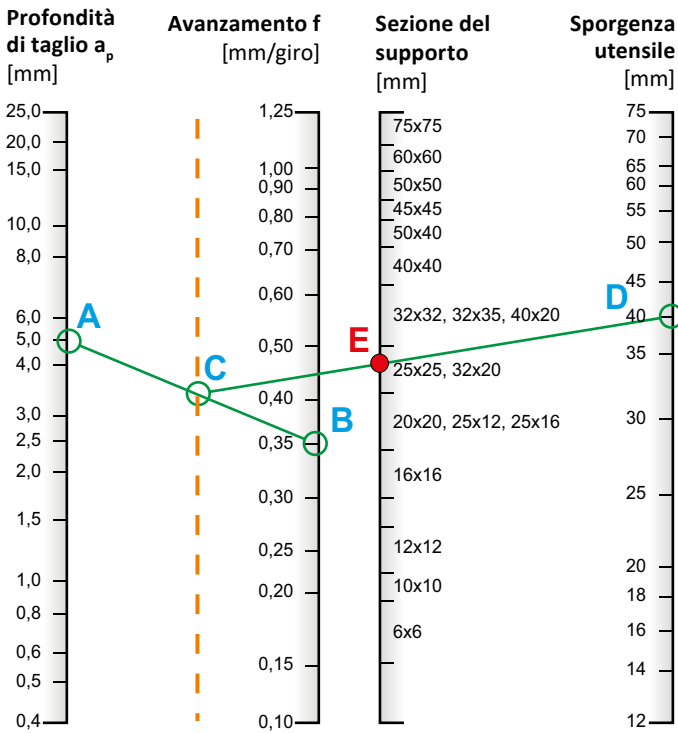

Sfortunatamente, non siamo in grado di offrire uno schema simile per la scelta del diametro dell'utensile da interno poiché la situazione nella tornitura interna viene complicata dal truciolo. A causa della maggiore sporgenza, è necessario scegliere un supporto con il diametro più grande possibile, ma se il diametro del supporto è vicino al diametro del foro da lavorare, possono verificarsi problemi nell'evacuazione del truciolo. Di solito si inserisce tra la parete del foro e il corpo del supporto danneggiando la superficie in formazione.

In genere, se si utilizzano utensili con un corpo in acciaio, la sporgenza non deve superare 4xD mentre, se si hanno utensili con un corpo in metallo duro o metallo ad alta densità, la sporgenza massima dovrebbe essere 6xD. Ricordarsi che per entrambi i tipi di utensile, la porzione riservata al bloccaggio dell'utensile dovrebbe essere almeno 3xD.

Utilizzare la **sezione trasversale massima possibile** per quanto riguarda le opzioni di bloccaggio e le limitazioni del processo.

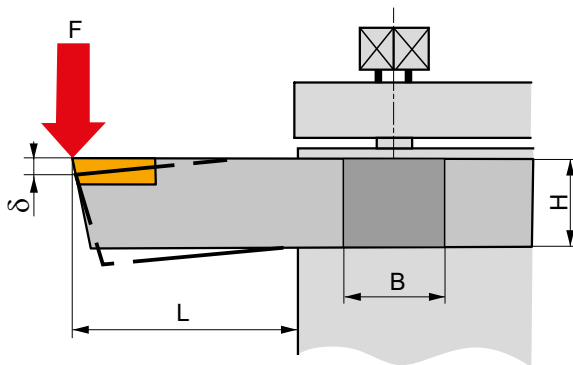

Sforzo in flessione

$$\sigma = \frac{6 \cdot F \cdot L}{B \cdot H^2} \text{ (MPa)}$$

Flessione portainserto

$$\delta = \frac{4 \cdot F \cdot L^3}{E \cdot B \cdot H^3} \text{ (mm)}$$

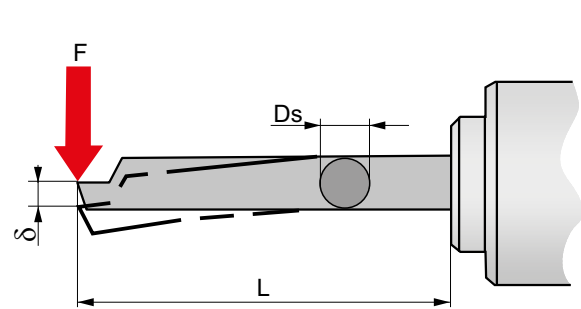

Sforzo in flessione

$$\sigma = \frac{32 \cdot F \cdot L}{\pi \cdot D_s^3} \text{ (MPa)}$$

Flessione portainserto



$$\delta = \frac{64 \cdot F \cdot L^3}{3 \cdot \pi \cdot E \cdot D_s^3} \text{ (mm)}$$

σ	Sforzo in flessione nel corpo [MPa]
F	Forza di taglio [N]
L	Sporgenza utensile [mm]
B	Larghezza corpo [mm]
H	Altezza corpo [mm]
D_s	Diametro corpo [mm]
E	Modulo di elasticità del materiale del corpo [MPa]

Materiale	MPa [N/mm ²]	[kgf/mm ²]
Acciaio	210.000	21.000
Metallo duro	560.000 – 620.00	56.000 – 62.00

Una riduzione del **50%** della sporgenza riduce la flessione dell'**88%**.
Un aumento di **1/3** della sezione trasversale riduce la flessione del **68%**.

Scelta della forma base e della grandezza dell'inserto

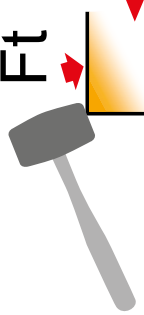
Priorità della scelta	Forma dell'inserto	Angolo di punta	Grandezza		Lunghezza massima del tagliente Lmax		Sgrossatura	Sgrossatura leggera	Finitura	Tornitura di profilo	Tornitura in piano	Applicazioni versatili	Tendenza a vibrare	Materiale duro	Taglio interrotto		
			ISO	ANSI	(mm)	(")											
<div style="display: flex; flex-direction: column; align-items: center;"> <div style="border: 1px solid red; padding: 5px; margin-bottom: 10px; width: 80%; text-align: center;"> Favorisce l'utilizzo in copiatura e la riduzione di vibrazioni. </div> <div style="display: flex; justify-content: center; gap: 20px;"> <div style="text-align: center;">  <p style="color: red; font-weight: bold; font-size: 2em;">+</p> </div> <div style="text-align: center;">  <p style="color: red; font-weight: bold; font-size: 2em;">I</p> </div> </div> <div style="display: flex; justify-content: center; gap: 20px; margin-bottom: 10px;"> <div style="text-align: center;"> <p style="color: red; font-weight: bold; font-size: 1.5em;">Pc [kW]</p> <p style="color: red; font-weight: bold; font-size: 1.5em;">↑</p> </div> <div style="text-align: center;"> <p style="color: red; font-weight: bold; font-size: 1.5em;">Pc [kW]</p> <p style="color: red; font-weight: bold; font-size: 1.5em;">↑</p> </div> </div> <div style="display: flex; justify-content: center; gap: 20px; margin-bottom: 10px;"> <div style="text-align: center;"> <p style="color: red; font-weight: bold; font-size: 2em;">1</p> <p style="color: red; font-weight: bold; font-size: 2em;">↓</p> </div> <div style="text-align: center;"> <p style="color: red; font-weight: bold; font-size: 2em;">2</p> <p style="color: red; font-weight: bold; font-size: 2em;">↓</p> </div> </div> <div style="display: flex; justify-content: center; align-items: center; gap: 20px;"> <div style="border: 1px solid red; padding: 5px; width: 80%; text-align: center;"> Aumenta la resistenza del tagliente, adatta per taglio interrotto. </div> <div style="text-align: center;">  <p style="color: red; font-weight: bold; font-size: 2em;">Ft</p> </div> </div> </div>	V	35°	11	2	0.25L	2.80	.110"										
			13			3.30	.130"		■	■	■	■					
			16	3		4.20	.165"										
	D	55°	07	2	0.25L	2.00	.078"										
			11	3		2.90	.114"		■	■	■	■	■	■			
			15	4		3.90	.153"										
	T	60°	11	2	0.33L	3.60	.141"										
			16	3		5.50	.216"	■	■	■	■	■	■	■			
			22	4		7.30	.287"	■	■	■	■	■	■	■			
			27	5		9.10	.358"	■	■	■	■	■	■	■			
	W	80°	06	3	0.50L	3.30	.129"	■	■	■	■	■	■	■	■	■	
			08	4		4.40	.173"										
	C	80°	06	2	0.66L	4.20	.165"										
			09	3		6.40	.251"										
			12	4		8.50	.334"	■	■	■	■	■	■	■			
			16	5		10.60	.417"										
			19	6		12.70	.500"										
	S	90°	09	3	0.66L	6.30	.248"										
			12	4		8.40	.330"										
			15	5		10.40	.409"	■	■		■		■	■			
			19	6		12.60	.496"										
			25	8		16.80	.661"										
	C	100°	12	4	0.66L	8.50	.334"										
			19	6		12.70	.500"	■			■		■	■			
25			8	16.50		.649"											
R		06		0.40D	2.40	.094"											
		08			3.20	.125"											
		10			4.00	.157"											
		12			4.80	.188"											
		15			6.00	.236"											
		16			6.40	.251"	■			■	■	■	■				
		19			7.60	.299"											
		20			8.00	.315"											
		25			10.00	.393"											
		32			12.80	.503"											

Sceita dello spessore ottimale dell'inserto

In base alla pratica, se ne consiglia l'utilizzo solo per tagli interrotti e al carico massimo degli inserti.

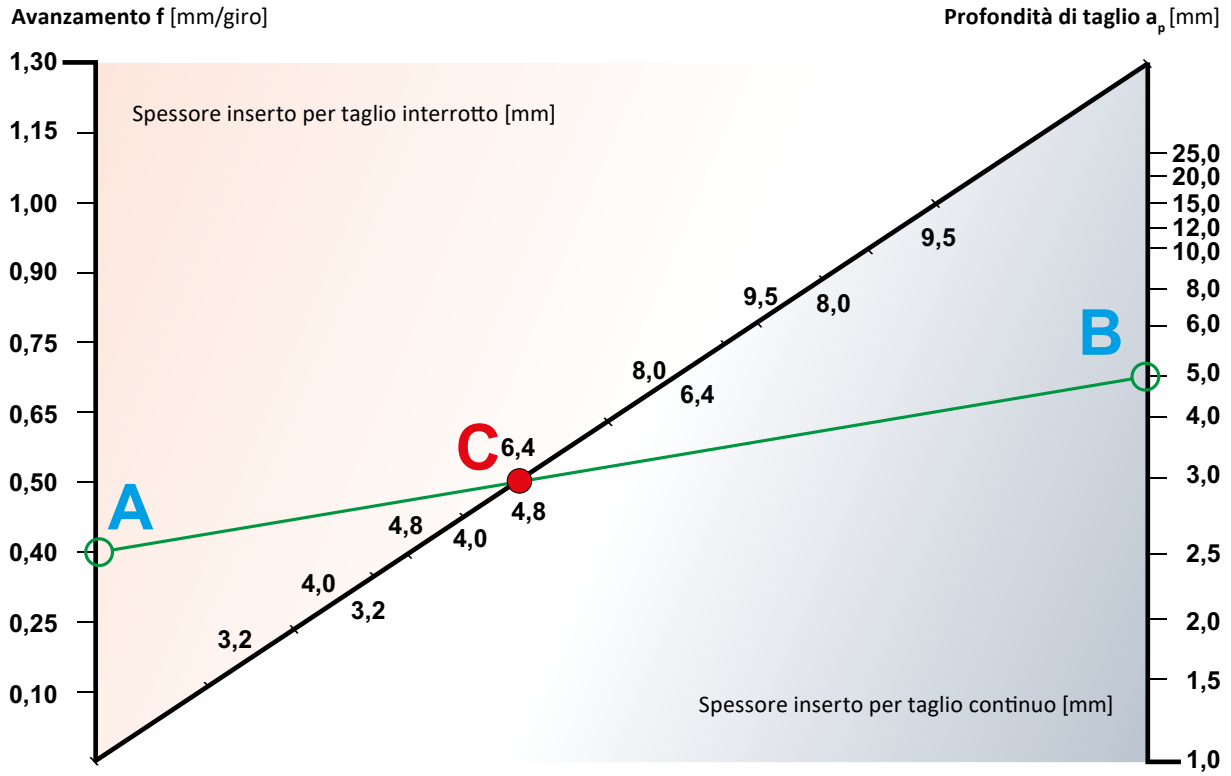

Sceita del raggio di punta ottimale dell'inserto

In base alla pratica, se ne consiglia l'utilizzo solo per tagli interrotti e al carico massimo di inserti.

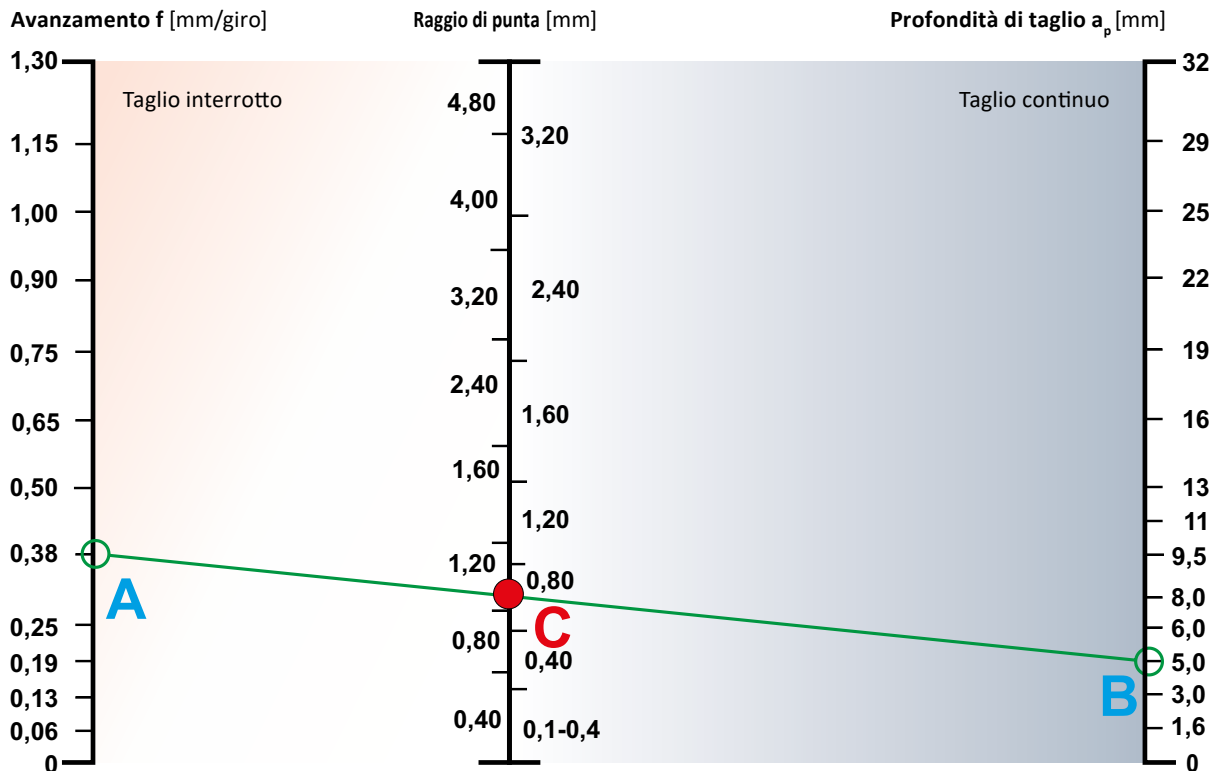

Il raggio dell'inserto, insieme all'avanzamento e all'angolo del tagliente secondario, è uno dei criteri principali per determinare la rugosità della superficie lavorata. Ovviamente, le proprietà e il tipo di materiale in lavorazione, comprese le condizioni di taglio, hanno un impatto significativo.

All'inizio di questa sezione, indichiamo i principali parametri di rugosità più spesso specificati nella pratica ingegneristica.

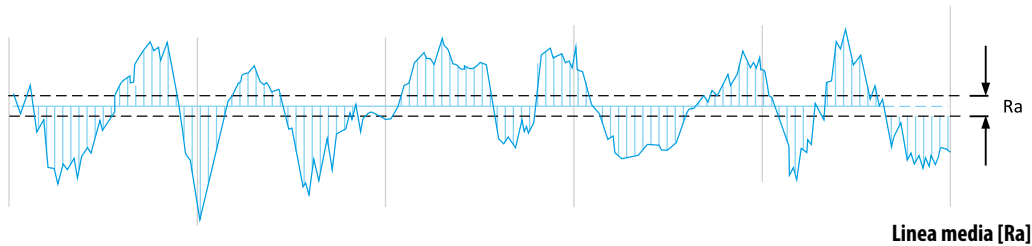

Ra – Rugosità media

Ra è anche nota come media aritmetica (AA) o linea media (CLA). È la rugosità media nell'area compresa tra il profilo di rugosità e la sua linea media. Graficamente, Ra è l'area tra il profilo di rugosità e la sua linea centrale divisa per la lunghezza di valutazione. Normalmente, la lunghezza di valutazione è di cinque lunghezze campione, dove ciascuna lunghezza campione è uguale a una lunghezza di campionamento. Come mostrato nel grafico.

Ra è di gran lunga il parametro di finitura superficiale più comunemente utilizzato e un buon punto di partenza per quantificare le parti anche quando non è presente alcun callout del parametro (finitura superficiale richiesta). Tuttavia, sebbene comune, Ra non è sufficiente per caratterizzare completamente la rugosità di una superficie. A seconda dell'applicazione, le superfici con la stessa rugosità possono comportarsi in modo molto diverso. Vediamo la stessa rugosità superficiale analizzata in altri 3 modi:

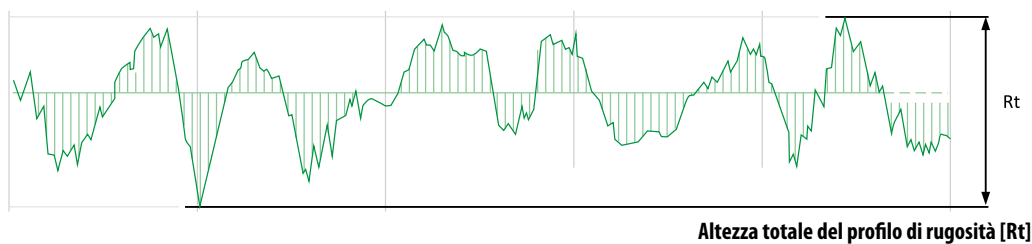

Rt – Altezza totale del profilo di rugosità

Differenza tra l'altezza del picco più alto e la profondità della valle più profonda all'interno della lunghezza di valutazione come si può vedere nel grafico in basso.

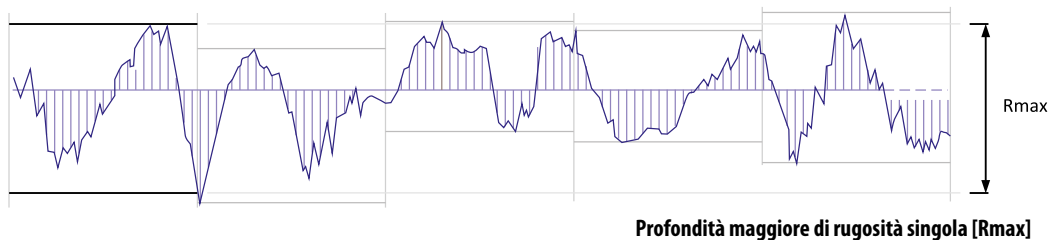

Rmax – Distanza massima dal picco più alto alla valle più bassa – della lunghezza di campionamento totale

O definendola in modo diverso, significa che la stessa Rmax è la profondità maggiore di rugosità singola misurata all'interno di una delle lunghezze campione. Rmax è particolarmente sensibile ad anomalie come graffi e sbavature che potrebbero non essere evidenti da misure come Ra che si basano su medie.

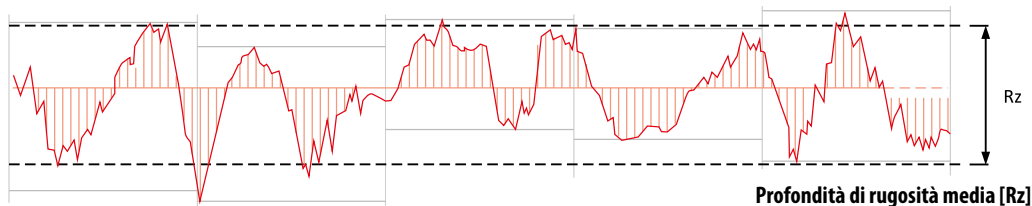

Rz – Profondità di rugosità media

Rz è spesso preferita a Ra in Europa e in particolare in Germania. Invece di misurare dalla linea centrale come Ra, Rz misura la media delle 5 maggiori differenze da picco a valle entro cinque lunghezze di campionamento. Mentre Ra è relativamente insensibile a pochi estremi, Rz è piuttosto sensibile poiché rappresenta gli estremi che è destinata a misurare.

Qualità di rugosità superficiale: numeri "N"

I numeri N vengono comunemente usati nei disegni tecnici per descrivere la rugosità della finitura superficiale. In passato si usavano triangoli ma non sono così efficaci per spiegare la corretta finitura superficiale.

Relazione con il simbolo del triangolo

Rugosità media aritmetica Ra [μm]	Max. rugosità in altezza Rz [μm]	Rugosità media su 10 punti RzJIS [μm]	Qualità di rugosità	Nota: (Relazione con triangolo)
0.025	0.1	0.1	N1	VVV
0.05	0.2	0.2	N2	
0.1	0.4	0.4	N3	
0.2	0.8	0.8	N4	
0.4	1.6	1.6	N5	VV
0.8	3.2	3.2	N6	
1.6	6.3	6.3	N7	
3.2	12.5	12.5	N8	V
6.3	25	25	N9	
12.5	50	50	N10	V
25	100	100	N11	

Nota: il simbolo di finitura (triangolo e onda~) è stato rimosso dallo standard JIS nella revisione del 1994.

In commercio si possono trovare dei "RugoTest" con cui controllare la finitura superficiale se non sono disponibili apparecchiature elettroniche. Tenere presente che rappresentano solo una guida e non sostituiscono alcuna misurazione



I valori di rugosità R_z e R_a specificati nelle seguenti tabelle sono validi per la tornitura utilizzando inserti con angoli del tagliente secondario $KAPR'$, ovvero inserti di forme base T..., S..., D..., K..., V... Nella tornitura utilizzando inserti di forme C..., W..., e in particolare utilizzando inserti con geometria RASCHIANTE – ovvero utensili con angoli del tagliente $KAPR = 90^\circ - 95^\circ$, solitamente ottengono valori di rugosità

inferiori R_a come si vede dai dati della tabella. Ciò è causato dal valore basso dell'angolo del tagliente secondario $KAPR'$. In questo caso le creste massime teoriche vengono ridotte a $R_{max3} < R_{max2} < R_{max1}$, come si evince dal confronto nella seguente figura.

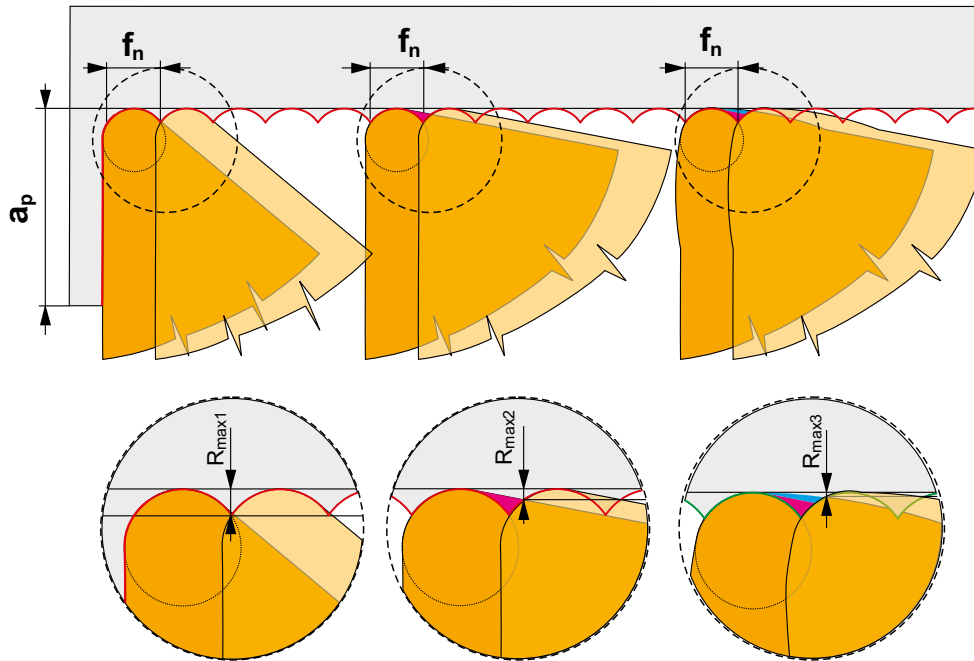

QUALITÀ DELLA SUPERFICIE

Qualità di superficie in tornitura R_{max}

$$R_{max} = \frac{f^2}{8 \cdot RE} \cdot 1000$$

f →	RE Raggio																			
	0.1	0.2	0.4	0.5	0.8	1.0	1.2	1.5	1.6	2.0	2.4	2.5	3.0	3.2	3.5	4.0	5.0	6.0	8.0	
	Qualità R_{max} (μm)																			
0.05	3.13	1.56	0.78	0.63	0.39	0.31	0.26	0.21	0.20	0.16	0.13	0.13	0.10	0.10	0.09	0.08	0.06	0.05	0.04	
0.07	6.1	3.06	1.53	1.23	0.77	0.61	0.51	0.41	0.38	0.31	0.26	0.25	0.20	0.19	0.18	0.15	0.12	0.10	0.08	
0.08	8.0	4.0	2.00	1.60	1.00	0.80	0.67	0.53	0.50	0.40	0.33	0.32	0.27	0.25	0.23	0.20	0.16	0.13	0.10	
0.10		6.3	3.13	2.50	1.56	1.25	1.04	0.83	0.78	0.63	0.52	0.50	0.42	0.39	0.36	0.31	0.25	0.21	0.16	
0.12		9.0	4.50	3.60	2.25	1.80	1.50	1.20	1.13	0.90	0.75	0.72	0.60	0.56	0.51	0.45	0.36	0.30	0.23	
0.15		14	7.0	5.6	3.52	2.81	2.34	1.88	1.76	1.41	1.17	1.13	0.94	0.88	0.80	0.70	0.56	0.47	0.35	
0.16		16	8.0	6.4	4.00	3.20	2.67	2.13	2.00	1.60	1.33	1.28	1.07	1.00	0.91	0.80	0.64	0.53	0.40	
0.18		20	10.1	8.1	5.1	4.05	3.38	2.70	2.53	2.03	1.69	1.62	1.35	1.27	1.16	1.01	0.81	0.68	0.51	
0.20			13	10.0	6.3	5.0	4.17	3.33	3.13	2.50	2.08	2.00	1.67	1.56	1.43	1.25	1.00	0.83	0.63	
0.22			15	12.1	7.6	6.1	5.0	4.03	3.78	3.03	2.52	2.42	2.02	1.89	1.73	1.51	1.21	1.01	0.76	
0.25			20	16	9.8	7.8	6.5	5.2	4.88	3.91	3.26	3.13	2.60	2.44	2.23	1.95	1.56	1.30	0.98	
0.27			23	18	11.4	9.1	7.6	6.1	5.7	4.56	3.80	3.65	3.04	2.85	2.60	2.28	1.82	1.52	1.14	
0.30			28	23	14	11.3	9.4	7.5	7.0	5.6	4.69	4.50	3.75	3.52	3.21	2.81	2.25	1.88	1.41	
0.32			32	26	16	13	10.7	8.5	8.0	6.4	5.3	5.1	4.27	4.00	3.66	3.20	2.56	2.13	1.60	
0.35			38	31	19	15	13	10.2	9.6	7.7	6.4	6.1	5.1	4.79	4.38	3.83	3.06	2.55	1.91	
0.37			43	34	21	17	14	11.4	10.7	8.6	7.1	6.8	5.7	5.3	4.89	4.28	3.42	2.85	2.14	
0.40				40	25	20	17	13	13	10.0	8.3	8.0	6.7	6.3	5.7	5.0	4.00	3.33	2.50	
0.45				51	32	25	21	17	16	13	10.5	10.1	8.4	7.9	7.2	6.3	5.1	4.22	3.16	
0.50					39	31	26	21	20	16	13	13	10.4	9.8	8.9	7.8	6.3	5.2	3.91	
0.55					47	38	32	25	24	19	16	15	13	11.8	10.8	9.5	7.6	6.3	4.73	
0.60					56	45	38	30	28	23	19	18	15	14	13	11.3	9.0	7.5	5.6	
0.65					66	53	44	35	33	26	22	21	18	17	15	13	10.6	8.8	6.6	
0.70					77	61	51	41	38	31	26	25	20	19	18	15	12.3	10.2	7.7	
0.75					88	70	59	47	44	35	29	28	23	22	20	18	14	11.7	8.8	
0.80						80	67	53	50	40	33	32	27	25	23	20	16	13	10.0	
0.85						90	75	60	56	45	38	36	30	28	26	23	18	15	11.3	
0.90						101	84	68	63	51	42	41	34	32	29	25	20	17	13	
0.95						113	94	75	71	56	47	45	38	35	32	28	23	19	14	
1.00							104	83	78	63	52	50	42	39	36	31	25	21	16	
1.20								120	113	90	75	72	60	56	51	45	36	30	23	
1.30								141	132	106	88	85	70	66	60	53	42	35	26	
1.40								163	153	123	102	98	82	77	70	61	49	41	31	
1.50									176	141	117	113	94	88	80	70	56	47	35	
1.60										160	133	128	107	100	91	80	64	53	40	
1.70										181	151	145	120	113	103	90	72	60	45	
1.80										203	169	162	135	127	116	101	81	68	51	
1.90										226	188	181	150	141	129	113	90	75	56	
2.00											208	200	167	156	143	125	100	83	63	
2.20												252	242	202	189	173	151	121	101	76
2.50														260	244	223	195	156	130	98

Elevate possibilità di scheggiature

Qualità di superficie in tornitura R_a

$$R_a = 43,9 \frac{f^{1,88}}{RE^{0,97}}$$

f ⇒	RE Raggio																		
	0.1	0.2	0.4	0.5	0.8	1.0	1.2	1.5	1.6	2.0	2.4	2.5	3.0	3.2	3.5	4.0	5.0	6.0	8.0
Qualità R_a (μm)																			
0.05	1.47	0.75	0.38	0.31	0.20	0.16	0.13	0.11	0.10	0.08	0.07	0.06	0.05	0.05	0.05	0.04	0.03	0.03	0.02
0.07	2.76	1.41	0.72	0.58	0.37	0.30	0.25	0.20	0.19	0.15	0.13	0.12	0.10	0.10	0.09	0.08	0.06	0.05	0.04
0.08	3.55	1.81	0.93	0.75	0.47	0.38	0.32	0.26	0.24	0.19	0.16	0.16	0.13	0.12	0.11	0.10	0.08	0.07	0.05
0.10		2.76	1.41	1.13	0.72	0.58	0.48	0.39	0.37	0.30	0.25	0.24	0.20	0.19	0.17	0.15	0.12	0.10	0.08
0.12		3.88	1.98	1.60	1.01	0.82	0.68	0.55	0.52	0.42	0.35	0.34	0.28	0.26	0.24	0.21	0.17	0.14	0.11
0.15		5.9	3.02	2.43	1.54	1.24	1.04	0.84	0.79	0.63	0.53	0.51	0.43	0.40	0.37	0.32	0.26	0.22	0.17
0.16		6.7	3.41	2.74	1.74	1.40	1.17	0.94	0.89	0.71	0.60	0.58	0.48	0.45	0.42	0.36	0.29	0.25	0.19
0.18		8.3	4.25	3.42	2.17	1.75	1.46	1.18	1.11	0.89	0.75	0.72	0.60	0.57	0.52	0.46	0.37	0.31	0.23
0.20			5.2	4.17	2.64	2.13	1.78	1.44	1.35	1.09	0.91	0.88	0.73	0.69	0.63	0.56	0.45	0.37	0.28
0.22			6.2	4.99	3.16	2.55	2.14	1.72	1.62	1.30	1.09	1.05	0.88	0.82	0.76	0.66	0.53	0.45	0.34
0.25			7.9	6.3	4.02	3.24	2.72	2.19	2.05	1.65	1.39	1.33	1.12	1.05	0.96	0.84	0.68	0.57	0.43
0.27			9.1	7.3	4.65	3.74	3.14	2.53	2.37	1.91	1.60	1.54	1.29	1.21	1.11	0.98	0.79	0.66	0.50
0.30			11.1	8.9	5.7	4.57	3.83	3.08	2.89	2.33	1.95	1.88	1.57	1.48	1.35	1.19	0.96	0.80	0.61
0.32			13	10.1	6.4	5.2	4.32	3.48	3.27	2.63	2.20	2.12	1.78	1.67	1.53	1.34	1.08	0.91	0.69
0.35			15	11.9	7.6	6.1	5.1	4.12	3.87	3.11	2.61	2.51	2.10	1.97	1.81	1.59	1.28	1.07	0.81
0.37			16	13	8.4	6.8	5.7	4.57	4.29	3.46	2.90	2.78	2.33	2.19	2.01	1.76	1.42	1.19	0.90
0.40				15	9.7	7.8	6.6	5.3	4.97	4.00	3.35	3.22	2.70	2.54	2.33	2.04	1.65	1.38	1.04
0.45				19	12.1	9.8	8.2	6.6	6.2	4.99	4.19	4.02	3.37	3.17	2.90	2.55	2.05	1.72	1.30
0.50					15	11.9	10.0	8.0	7.6	6.1	5.1	4.90	4.11	3.86	3.54	3.11	2.50	2.10	1.59
0.55					18	14	12.0	9.6	9.0	7.3	6.1	5.9	4.92	4.62	4.23	3.72	2.99	2.51	1.90
0.60					21	17	14	11.3	10.7	8.6	7.2	6.9	5.8	5.4	4.98	4.38	3.53	2.96	2.24
0.65					24	20	16	13	12.4	10.0	8.4	8.0	6.7	6.3	5.8	5.1	4.10	3.44	2.60
0.70					28	22	19	15	14	11.5	9.6	9.2	7.7	7.3	6.7	5.9	4.71	3.95	2.99
0.75					32	26	21	17	16	13	10.9	10.5	8.8	8.3	7.6	6.7	5.4	4.50	3.40
0.80						29	24	19	18	15	12.3	11.9	9.9	9.3	8.6	7.5	6.1	5.1	3.84
0.85						32	27	22	21	17	14	13	11.1	10.5	9.6	8.4	6.8	5.7	4.30
0.90						36	30	24	23	18	15	15	12.4	11.7	10.7	9.4	7.6	6.3	4.79
0.95						40	33	27	25	20	17	16	14	13	11.8	10.4	8.4	7.0	5.3
1.00							37	30	28	22	19	18	15	14	13	11.4	9.2	7.7	5.8
1.20								42	39	32	26	25	21	20	18	16	13	10.9	8.2
1.30								49	46	37	31	30	25	23	21	19	15	13	9.6
1.40								56	52	42	35	34	28	27	25	22	17	15	11.0
1.50									60	48	40	39	32	30	28	25	20	17	13
1.60										54	45	44	37	34	32	28	22	19	14
1.70										61	51	49	41	39	35	31	25	21	16
1.80										68	57	54	46	43	39	35	28	23	18
1.90										75	63	60	51	47	44	38	31	26	20
2.00											69	66	56	52	48	42	34	28	21
2.20												83	79	67	63	57	41	34	26
2.50													85	80	73	64	52	43	33

Elevate possibilità di scheggiature



Difficoltà nella formazione del truciolo – grande attenzione deve essere posta alla corretta formazione del truciolo (il truciolo deve essere facilmente allontanato dal punto di taglio e, al contempo, deve avere la più piccola deformazione plastica possibile, cioè le più basse forze di taglio possibili).

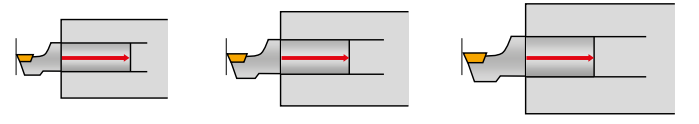

Sezione del corpo utensile (rigidità di bloccaggio) – la rigidità del bloccaggio stesso è importante. Pertanto, si consiglia di utilizzare utensili con la sezione del corpo più ampia possibile che può essere bloccata. Consigliato anche utilizzare utensili a cambio rapido (PSC).

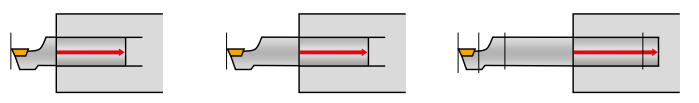

Sporgenza (rigidità di bloccaggio) – anche la sporgenza dell'utensile, o la rigidità del bloccaggio stesso, è di grande importanza. Pertanto, si consiglia di ridurre al minimo la sporgenza.



Angolo del tagliente utensile – idealmente, l'angolo di regolazione dell'utensile dovrebbe essere vicino a 90°, cioè le forze dovrebbero essere dirette il più possibile verso l'asse del mandrino della macchina.

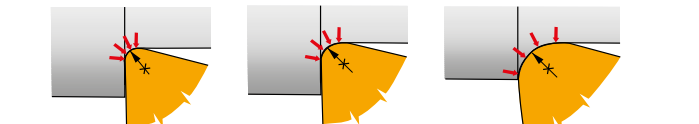

Raggio dell'inserto – in caso di rischio di vibrazioni, si consiglia di scegliere un inserto con il raggio di punta più piccolo possibile.

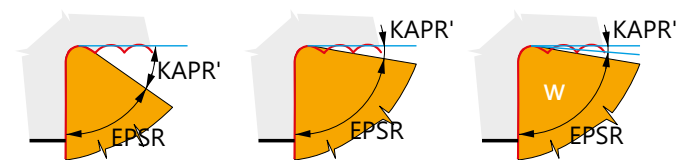

Angolo di punta e angolo del tagliente secondario – in questo caso si consiglia di scegliere un inserto con l'angolo di punta più piccolo possibile, cioè V (35°), D o K (55°), o T (60°). Forme C o W, inserti con geometria RASCHIANTE non sono raccomandati. Da notare che ciò non sempre è valido (se si verificano anche vibrazioni torsionali, l'applicazione di questi inserti può essere vantaggiosa).

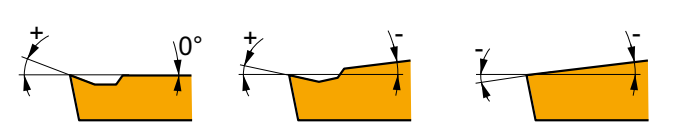

Geometria – durante la tornitura di parti a parete sottile e sottili, si consiglia di optare per inserti positivi con geometria positiva, inserti negativi con geometria positiva e, solo se non c'è altra scelta, si dovrebbero scegliere inserti negativi con geometria da neutra a negativa.



Microgeometria (design del tagliente) – per ridurre il rischio di vibrazioni, è necessario scegliere inserti con la geometria del tagliente più affilata possibile. Se si utilizzano inserti con rinforzo del tagliente, questi dovrebbero essere i più stretti e positivi possibile. È molto importante che l'utensile generi la minor resistenza possibile al taglio.

Condizioni di taglio:

- 1) Quando si sceglie la profondità di taglio, assicurarsi sempre che la profondità di taglio sia maggiore del raggio dell'inserto.
- 2) Nella scelta dell'avanzamento, tenere presente che la resistenza al taglio specifica aumenta con la diminuzione dello spessore del truciolo, ovvero non utilizzare avanzamenti estremamente bassi (inferiori a 0,1 mm).
- 3) In caso di vibrazioni, può essere d'aiuto anche il cambio della velocità di taglio (+/-) – correlato alla frequenza intrinseca della macchina.

NOTA: Spesso è vantaggioso ridurre la profondità di taglio (non al di sotto del raggio) e aumentare l'avanzamento.

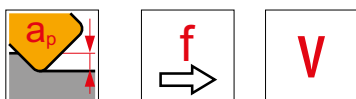

Non utilizzare inserti usurati – l'abrasione del fianco provoca un aumento delle forze di taglio e quindi il rischio di vibrazioni.

Se il bloccaggio utensile lo permette, spostare il tagliente sopra l'asse (nella tornitura esterna) di circa il 2% del diametro.

SCelta DELLE CONDIZIONI DI TAGLIO

Scelta del rompitruciolo

La forma del truciolo dipende da diversi fattori – le proprietà del componente lavorato, la resistenza del materiale, la tenacità e la microstruttura, le proprietà della qualità dell'inserto, in particolare le proprietà di attrito (sulla faccia della spoglia), la geometria del tagliente, le condizioni di taglio e il tipo di rompitruciolo, ma anche le proprietà statiche e dinamiche della macchina.

Virtualmente tutti questi fattori nel processo di taglio lavorano per combinare e determinare la forma del truciolo (azione di taglio, flusso

del truciolo o truciolo arricciato – che può raccogliere e intasare l'area di lavorazione). Ogni rompitruciolo funziona in un intervallo definito di avanzamento e profondità di taglio.

L'avanzamento minimo al quale funziona il rompitruciolo dipende dalla larghezza del bordino superiore "x" e dal suo angolo. L'avanzamento massimo dipende dalla distanza dal tagliente all'estremità del rompitruciolo y e dalla profondità del rompitruciolo z.

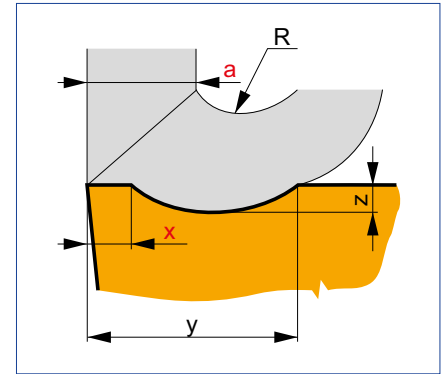
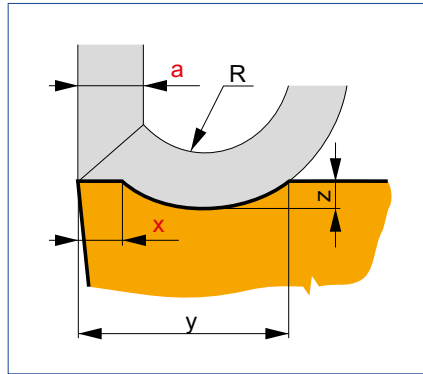
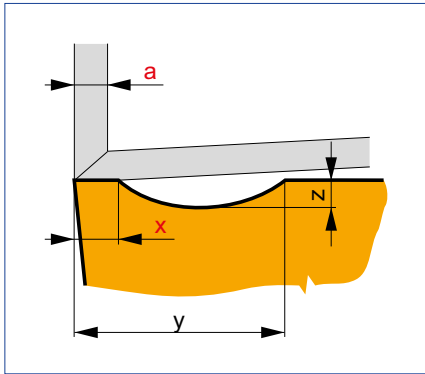

Se lo spessore dello strato "a" tagliato (per angolo del tagliente $KAPR = 90^\circ$, uguale all'avanzamento) è notevolmente inferiore al rinforzo del tagliente "x", il truciolo è solo a contatto con lo smusso. Non può entrare nel rompitruciolo e quindi non può essere rotto (vedere figura).

Se l'avanzamento "f" è maggiore (spessore maggiore della profondità di "a" e $x < a$ (f), il truciolo entra nel rompitruciolo e viene curvato a valori specifici di raggio R (vedere figura).

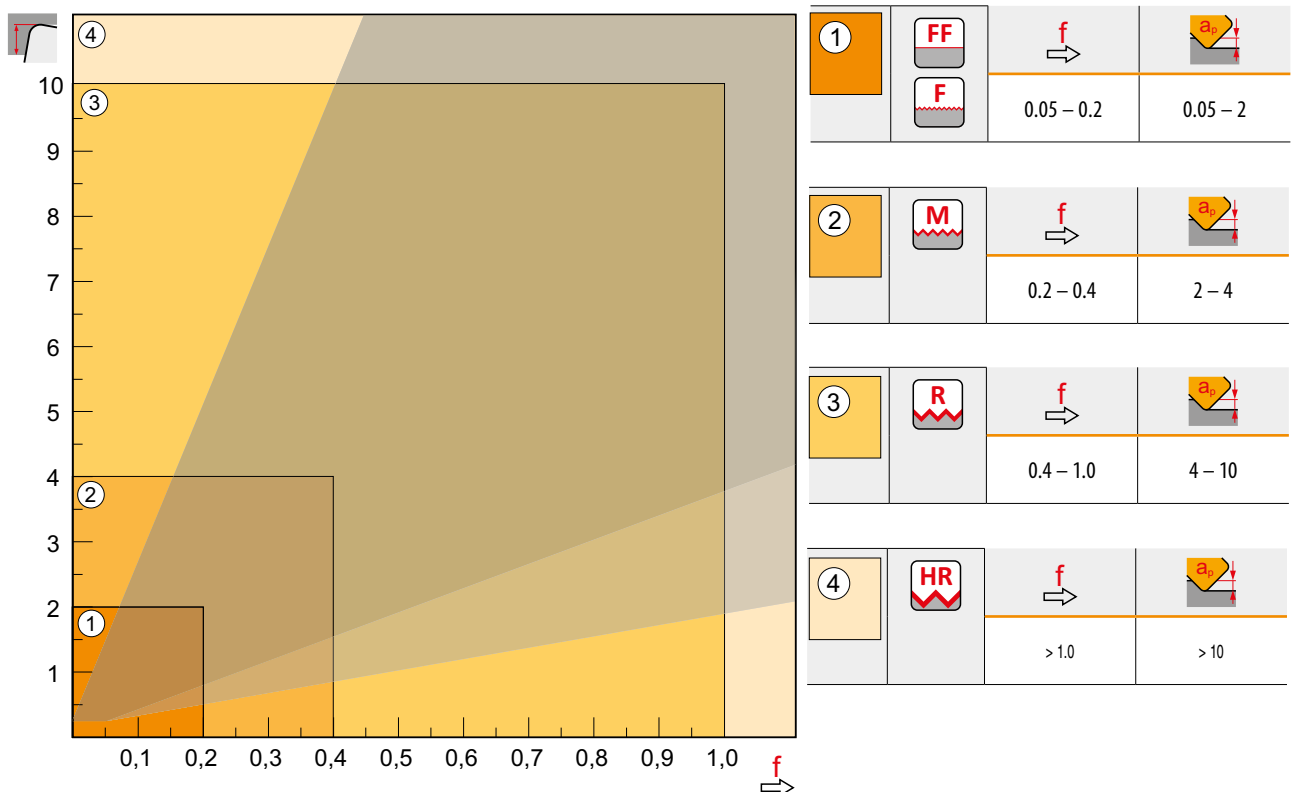

Se $x \ll a$ (vedere figura) il truciolo viene deformato eccessivamente (il truciolo viene schiacciato). Se il truciolo non segue il canale del rompitruciolo il rompitruciolo non verrà rotto.

Tutti i rompitrucioli lavorano in un intervallo definito di condizioni di taglio. Ecco perché l'area di rottura del truciolo viene indicata come un intervallo continuo per definire le combinazioni di profondità di taglio e avanzamento più comunemente utilizzate (vedere la figura seguente). Anche gli intervalli di applicazione del rompitruciolo si sovrappongono.

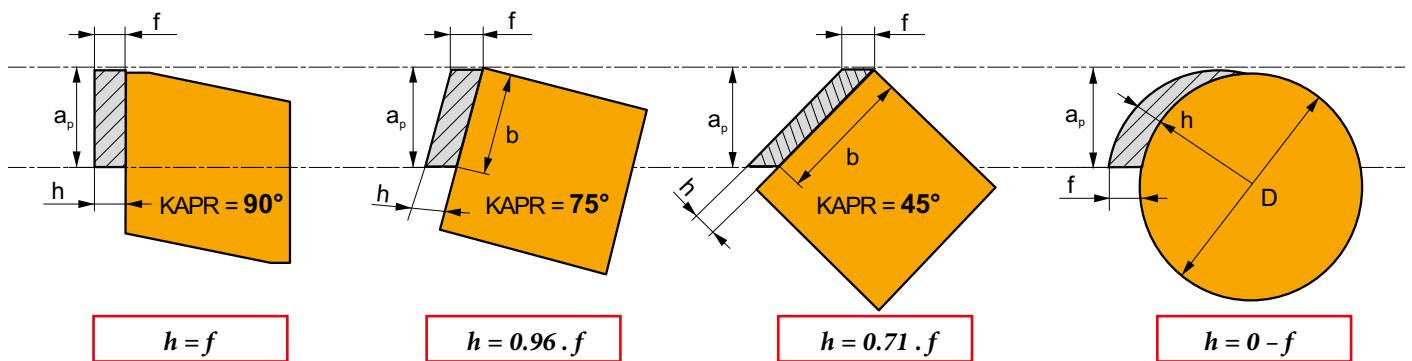



La combinazione ottimale di profondità di taglio e avanzamento varia da materiale a materiale. La seguente tabella mostra gli intervalli dei rapporti ottimali b (larghezza del truciolo) su h (spessore del truciolo). Per angoli di regolazione vicini a 90° , questo è essenzialmente il rapporto tra profondità di taglio e avanzamento. Vedere figura.

Materiale		min b/h	max b/h	
P		5	15	
M	8	12		
K	3	30		
N	9	11		
S	Truciolo quadrato $b=h$	8	12	Truciolo a nastro $b/h > 30$
H	5	20		

Come si vede dalla tabella, nella scelta delle condizioni di taglio è opportuno evitare il cosiddetto truciolo quadrato, cioè valori dove la larghezza è prossima allo spessore del truciolo e, d'altra parte, il truciolo a nastro, cioè alte profondità di taglio.

La tabella sopra mostra che la formazione di trucioli più problema-

tica riguarda le leghe di metalli non ferrosi, in particolare le leghe di alluminio con o senza contenuto di silicio. Seguono le superleghe e gli acciai inossidabili (in particolare gli acciai austenitici e duplex). Poi ci sono gli acciai, mentre la situazione migliore è con i materiali temprati e le ghise.

SCelta DELL'UTENSILE

Inoltre, tenere presente che il diagramma di formazione del truciolo si sposta leggermente verso profondità di taglio maggiori (in alto), con l'aumentare della lunghezza del tagliante (dimensione dell'inserto) e verso avanzamenti maggiori (a destra), con l'aumentare del raggio.

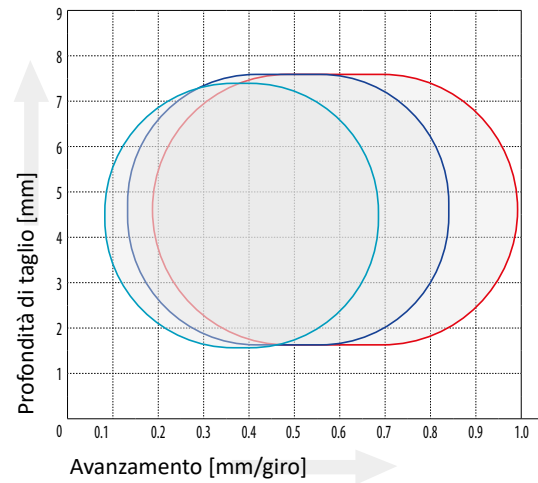
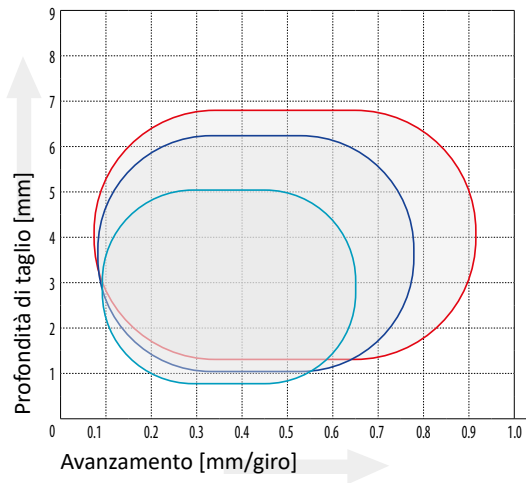

- Un inserto con il diametro di un cerchio inscritto IC = 19.050 [mm]
- Un inserto con il diametro di un cerchio inscritto IC = 15.875 [mm]
- Un inserto con il diametro di un cerchio inscritto IC = 12.700 [mm]

- Un inserto con il raggio di punta RE = 1.6 [mm]
- Un inserto con il raggio di punta RE = 1.2 [mm]
- Un inserto con il raggio di punta RE = 0.8 [mm]

A parte la forma del truciolo, anche la direzione della sua evacuazione è molto importante. La seguente figura mostra le direzioni di base per l'evacuazione del truciolo:

- 1 – dal pezzo da lavorare nella direzione di avanzamento,
- 2 – verso il pezzo da lavorare nella direzione di avanzamento
- 3 – verso il pezzo da lavorare contro l'avanzamento,
- 4 – dal pezzo da lavorare contro l'avanzamento,

- 5 – rotto contro la superficie dell'area di taglio,
- 6 – rotto contro il lato dell'utensile,
- 7 – rotto contro la superficie in lavorazione,
- 8 – rotto contro la superficie lavorata,

Ovviamente, le direzioni che possono causare danni o graffi sulla superficie lavorata sono da evitare.

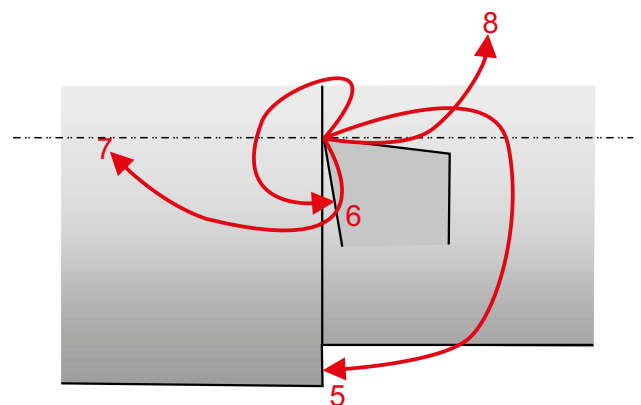
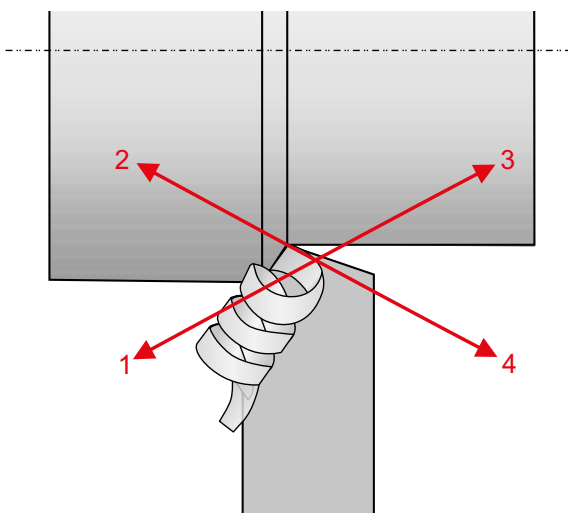

La seguente sezione specifica chiaramente tutte le geometrie che offriamo in gruppi strutturati. Queste tabelle dovrebbero aiutare nella scelta ottimale e più accurata.

PANORAMICA DELLE GEOMETRIE DEGLI INSERTI DI TORNITURA

INSERTI POSITIVI Designazione bloccaggio ISO S		INSERTI NEGATIVI Designazione bloccaggio ISO P, M, D		GEOMETRIA DI TAGLIO INSERTI DI SCANALATURA Designazione bloccaggio iso X e G	
371 (RCMT)	565	000 (LNUX)	575	GM (GL.D)	586
372 (RCMT)	565	002 (LNUX)	575	MM (GL.D)	586
...W	565	003 (LNUX)	575	PM (GL. D)	586
AL	565	08 (RNMG)	575	PR (GL. D)	586
DR4 (SCMT)	566	81 (RNMG)	576	13 CM (LCMF)	587
FF	566	432 (LNMX)	576	13 F (LCM.)	587
FF2	566	923	576	13 MP (LCM.)	587
FM	566	...A	576	16 CM (LCM.)	587
FM (RCMT)	567	DR	577	16 F (LCM.)	588
FM2	567	FF	577	16 M (LCM.)	588
NF1	567	FM	577	16 MP (LCM.)	588
NF2	567	HR	577	20 F1 (LCMF)	588
OR (SCMT)	568	HR2	578	20 M2 (LCMF)	589
RF	568	KR	578	30 F (LCM.)	589
RM	568	M	578	F1 (LFMX)	589
RM3	568	NF	578	F2 (LFMX)	589
SF2	569	NM	579	M2 (LFMX)	590
SF3	569	NMR	579	LFUX	590
SI	569	NR	579	TN. EXT	591
SR (SCMT)	569	NRM	579	TN. INT	591
UR (RCMT)	570	NR2	580	X61	591
UR	570	OR	580	X61 R	591
W-FM	570	OR1	580		
W-UR	570	R	580		
46	571	RM	581		
47	571	SF	581		
48	571	SI	581		
61	571	SM	581		
.PUN	572	SR	582		
		W-MR	582		
		W-F	582		
		W-M	582		
		W-NM	583		
INSERTI POSITIVI Designazione bloccaggio ISO P, M, D		INSERTI NEGATIVI Designazione bloccaggio ISO C			
31 (RCMX)	573	22	584		
321 (RCMX)	573	32	584		
331 (RCMX)	573	72	584		
361 (RCMX)	573	73	584		
RF1 (RCMX)	574	74	585		
RM1 (RCMX)	574				
RM2 (RCM.)	574				
RR2 (RCM.)	574				

GEOMETRIA DEGLI INSERTI DI TORNITURA POSITIVI – DESIGNAZIONE BLOCCAGGIO ISO S

371 (RCMT)

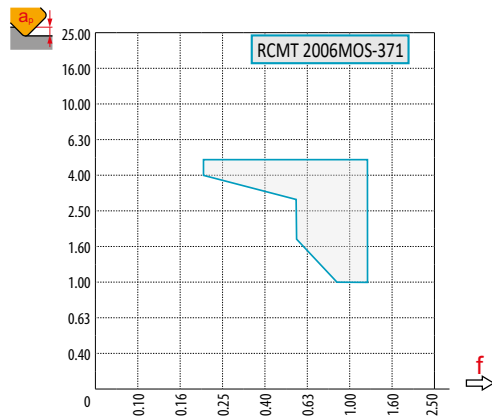
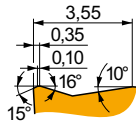

P	M	K	N	S	H
■		■			
f	0.20 – 1.20				
a_p	1.0 – 5.0				
?	RCMT				

372 (RCMT)

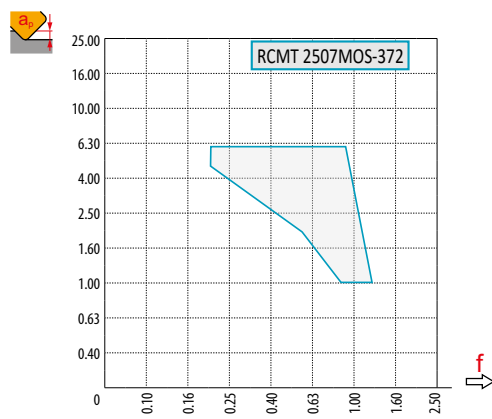
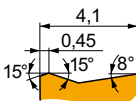

P	M	K	N	S	H
■		■			
f	0.20 – 1.20				
a_p	1.0 – 6.0				
?	RCMT				

...W

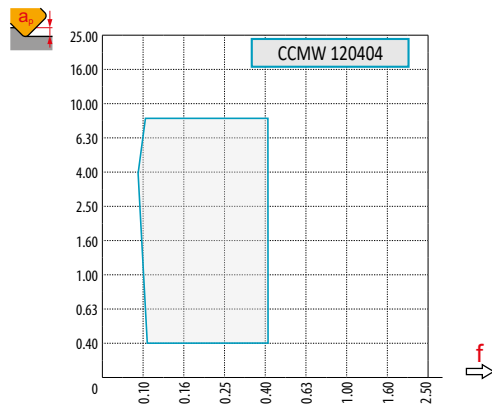
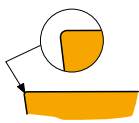
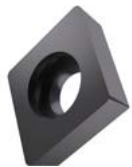

P	M	K	N	S	H
		■			■
f	0.05 – 0.60				
a_p	0.4 – 8.4				
?	CCMW, DCMW, SCMW, RCMW, TCMW, VCMW				

AL

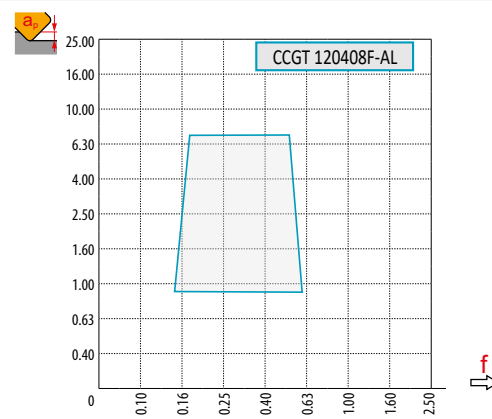

P	M	K	N	S	H
			■	■	
f	0.05 – 0.60				
a_p	0.2 – 7.0				
?	CCGT, DCGT, SCGT, RCGT, TCGT, VCGT, WCGT				

GEOMETRIA DEGLI INSERTI DI TORNITURA POSITIVI – DESIGNAZIONE BLOCCAGGIO ISO S

DR4 (SCMT)

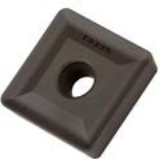
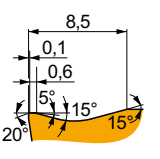
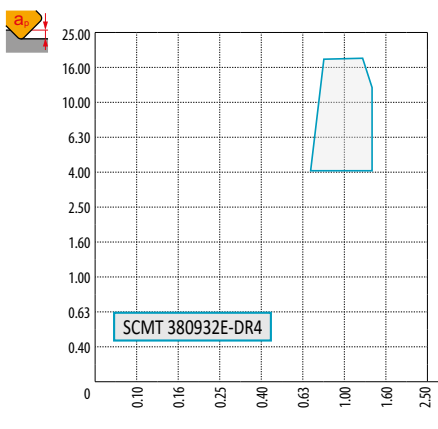
Graph labels: SCMT 380932E-DR4

P	M	K	N	S	H
■	▣	■	■	■	■
f	0.70 – 1.40				
a_p	4.0 – 18.0				



? SCMT

FF

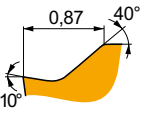
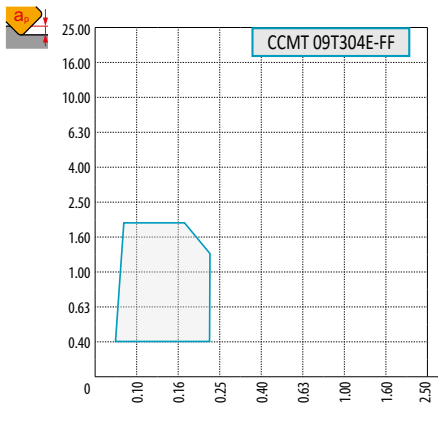
Graph labels: CCMT 09T304E-FF

P	M	K	N	S	H
■	▣	■	■	■	■
f	0.05 – 0.23				
a_p	0.2 – 2.0				



? CCMT, DCMT

FF2

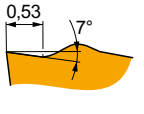
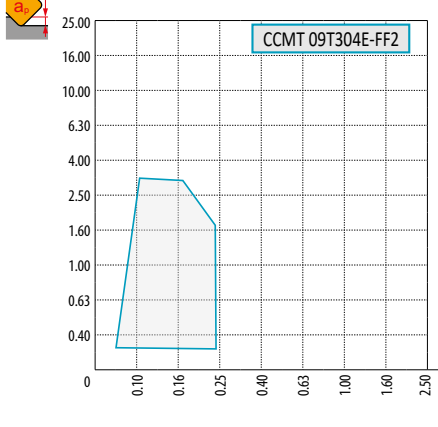

Graph labels: CCMT 09T304E-FF2

P	M	K	N	S	H
■	■	■	■	■	■
f	0.02 – 0.28				
a_p	0.20 – 3.0				

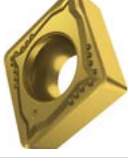

? CCMT, CCGT, DCGT, DCMT, SCMT, TCMT, VBMT, VCGT, VCGX, WCGT

FM

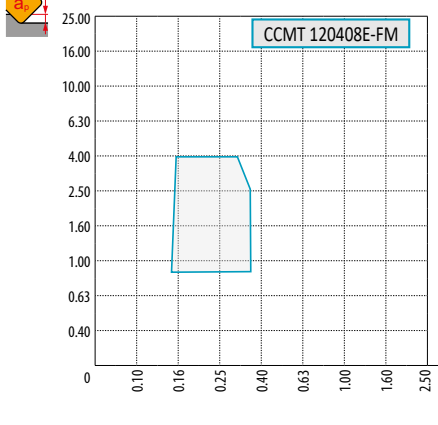
Graph labels: CCMT 120408E-FM

P	M	K	N	S	H
■	■	▣	▣	■	■
f	0.05 – 0.45				
a_p	0.2 – 4.0				



? CCMT, DCMT, SCMT, TCMT, VBMT, WCMT

GEOMETRIA DEGLI INSERTI DI TORNITURA POSITIVI – DESIGNAZIONE BLOCCAGGIO ISO S



FM (RCMT)

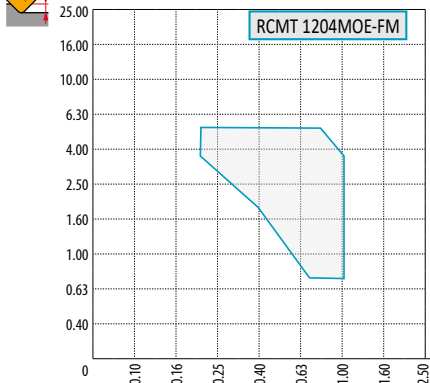

RCMT 1204MOE-FM



P	M	K	N	S	H
■	■	▣	▣	■	■
f	0.10 – 1.0				
a_p	0.3 – 5.0				





? RCMT



FM2

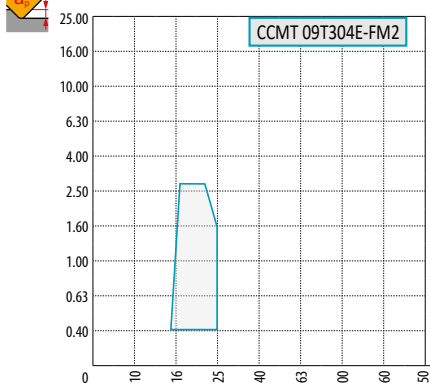

CCMT 09T304E-FM2



P	M	K	N	S	H
■	▣	■	■	■	■
f	0.04 – 0.4				
a_p	0.2 – 4.0				





? CCMT, DCMT, ECMT, SCMT, TCMT, VBMT, VCGT



NF1

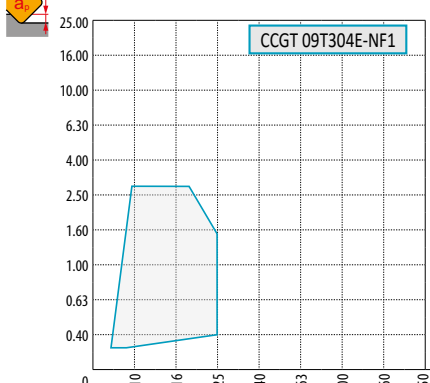

CCGT 09T304E-NF1



P	M	K	N	S	H
■	■	■	▣	■	▣
f	0.04 – 0.35				
a_p	0.3 – 3.5				





? CCGT, DCGT, SCGT, TCGT



NF2

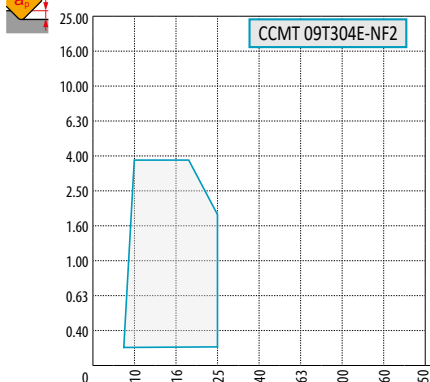

CCMT 09T304E-NF2



P	M	K	N	S	H
▣	■	▣	▣	■	■
f	0.05 – 0.45				
a_p	0.2 – 4.0				

? CCMT, EPMT, SCMT, TCMT, VCGT

GEOMETRIA DEGLI INSERTI DI TORNITURA POSITIVI – DESIGNAZIONE BLOCCAGGIO ISO S

OR (SCMT)

P	M	K	N	S	H
■	■	■	■	■	■

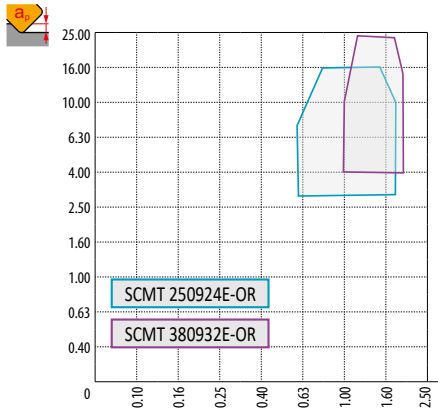
f : 0.60 – 2.00

a_p : 3.0 – 24.0



? SCMT

RF



I.C.	R
6,35	1,0
9,525	1,5
12,7	2,5

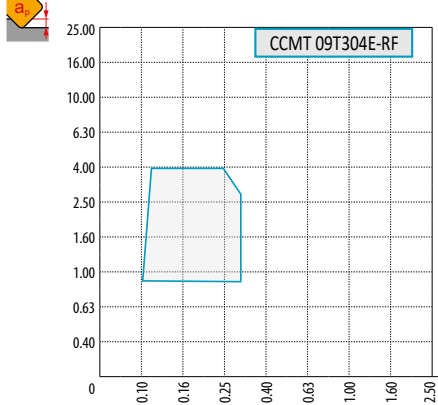

P	M	K	N	S	H
■	■	■	■	■	■

f : 0.10 – 0.60

a_p : 0.8 – 8.0



? CCMT, DCMT, SCMT, TCMT, WCMT

RM

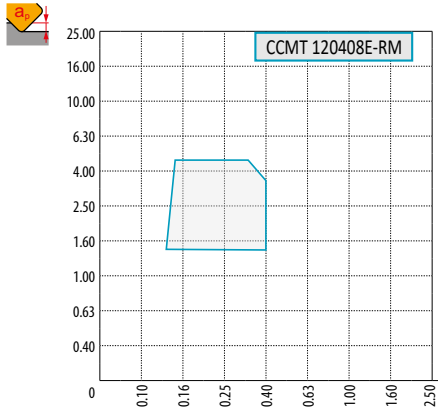
P	M	K	N	S	H
■	■	■	■	■	■

f : 0.10 – 0.50

a_p : 0.8 – 4.5



? CCMT, DCMT, SCMT, TCMT, VBMT

RM3

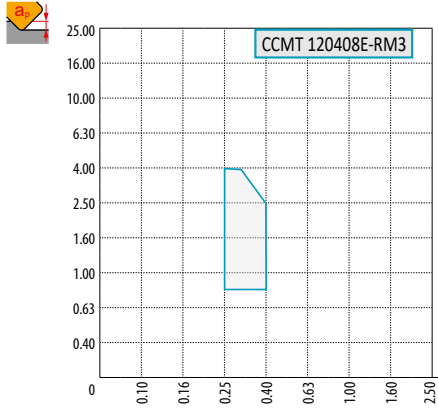
P	M	K	N	S	H
■	■	■	■	■	■

f : 0.15 – 0.90

a_p : 0.4 – 6.00



? CCMT, SCMT, TCMT, RCMT

GEOMETRIA DEGLI INSERTI DI TORNITURA POSITIVI – DESIGNAZIONE BLOCCAGGIO ISO S

SF2



ECGT 080304E-SF2

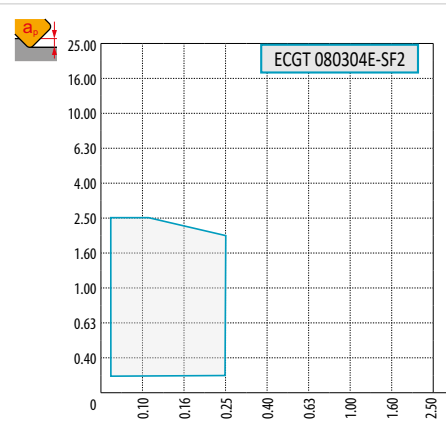

P	M	K	N	S	H
☑	■	■	☑	■	
f	0.02 – 0.28				
a_p	0.1 – 2.5				

ECGT, VCGT

SF3



CCGT 09T304E-SF3

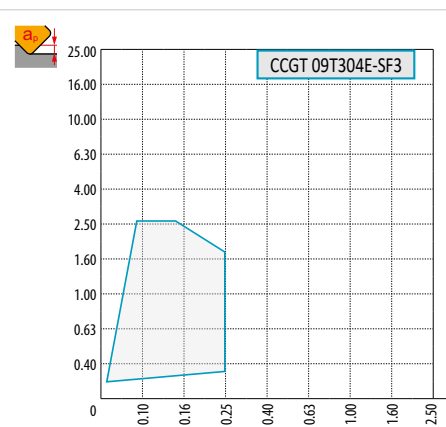

P	M	K	N	S	H
☑	■	☑	■	■	☑
f	0.02 – 0.35				
a_p	0.2 – 4.00				

CCGT, DCGT, ECGT, SCGT, TCGT, VCGT

SI



CCGT 120408E-SI

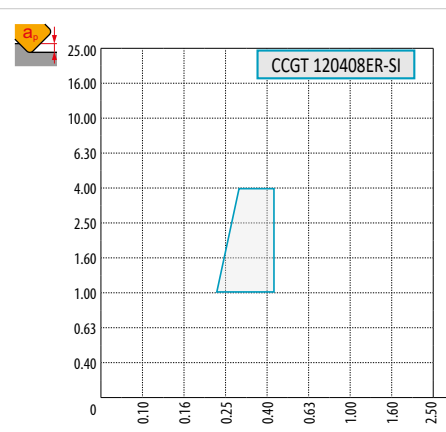

P	M	K	N	S	H
■	■	☑		■	
f	0.08 – 0.45				
a_p	0.4 – 4.0				

CCGT, TCGT

SR (SCMT)

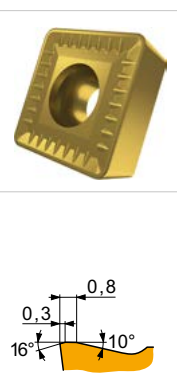

SCMT 250924E-SR
SCMT 380932E-SR

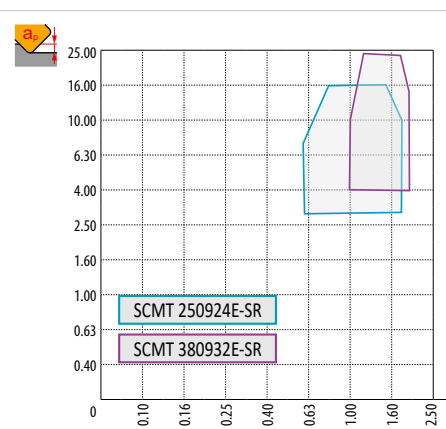

P	M	K	N	S	H
■	■	■			
f	0.60 – 2.0				
a_p	3.0 – 24.0				

SCMT

GEOMETRIA DEGLI INSERTI DI TORNITURA POSITIVI – DESIGNAZIONE BLOCCAGGIO ISO S

UR (RCMT)

RCMT 10T3MOE-UR

P	M	K	N	S	H
■	▣	■	■	■	■
f	0.15 – 1.00				
a_p	0.5 – 5.0				

? RCMT

UR

CCMT 120408E-UR

P	M	K	N	S	H
■	▣	■	■	■	■
f	0.10 – 0.40				
a_p	1.0 – 4.0				

? CCMT, DCMT, RCMT, SCMT, TCMT, VCMT, VBMT, WCMT

W-FM

CCMT 09T304W-FM

P	M	K	N	S	H
■	■	■	■	■	■
f	0.1 – 0.4				
a_p	0.3 – 3.0				

? CCMT, DCMX

W-UR

CCMT 09T308W-UR

P	M	K	N	S	H
■	▣	■	■	■	■
f	0.08 – 0.5				
a_p	0.4 – 3.0				

? CCMT

GEOMETRIA DEGLI INSERTI DI TORNITURA POSITIVI – DESIGNAZIONE BLOCCAGGIO ISO C

46

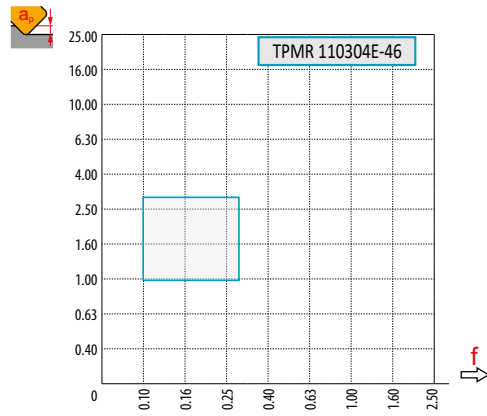
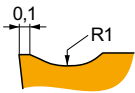

P	M	K	N	S	H
■	▣	■	■	■	■
f	0.10 – 0.30				
a_p	1.0 – 3.0				
?	SPMR, TPMPR				

47

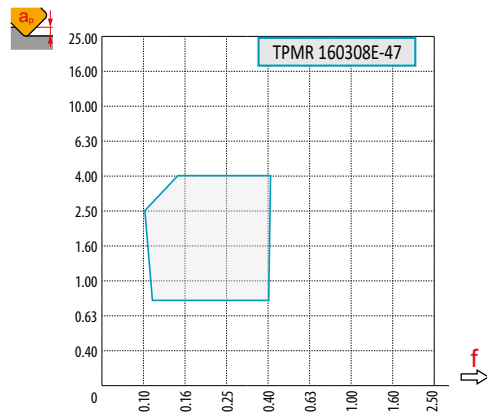
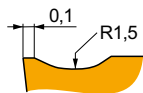

P	M	K	N	S	H
■	▣	■	■	■	■
f	0.10 – 0.40				
a_p	0.8 – 4.0				
?	TPMPR				

48

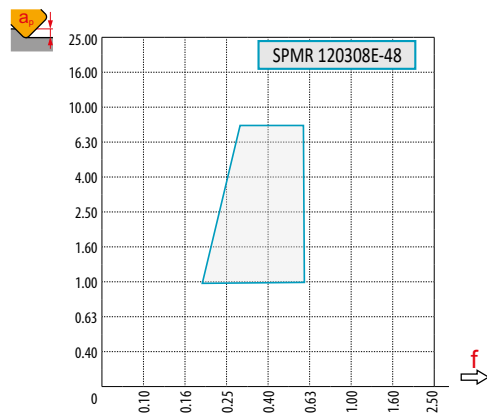
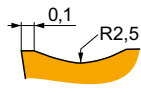
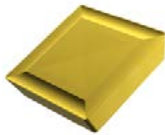

P	M	K	N	S	H
■	▣	■	■	■	■
f	0.20 – 0.60				
a_p	1.0 – 8.0				
?	SPMR				

61

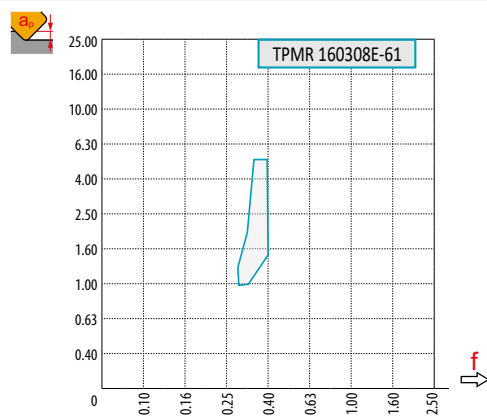
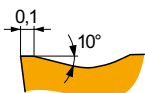

P	M	K	N	S	H
■	▣	■	■	■	■
f	0.30 – 0.40				
a_p	1.0 – 5.3				
?	TPMPR				

GEOMETRIA DEGLI INSERTI DI TORNITURA POSITIVI – DESIGNAZIONE BLOCCAGGIO ISO C

.PUN





IN BASE AL TIPO E AL SETTAGGIO
DEL ROMPITRUCIOLO

P	M	K	N	S	H
☐		■			☐
f ⇨	0.10 – 0.60				
a_p ⇩	0.4 – 17.5				





?

TPUN, SPUN

GEOMETRIA DEGLI INSERTI DI TORNITURA POSITIVI – DESIGNAZIONE BLOCCAGGIO ISO P, M, D

31 (RCMX)

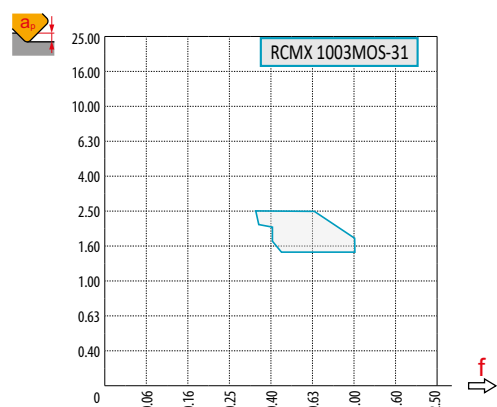
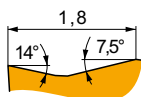

P	M	K	N	S	H
■	■	■	■	■	■
f	0.40 – 1.00				
a_p	1.5 – 2.5				
?	RCMX				

321 (RCMX)

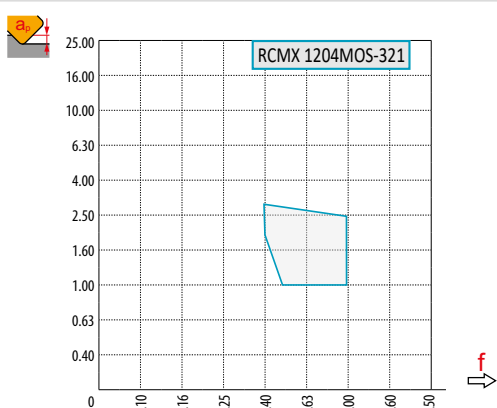
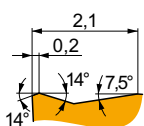

P	M	K	N	S	H
■	■	■	■	■	■
f	0.40 – 1.00				
a_p	1.0 – 3.0				
?	RCMX				

331 (RCMX)

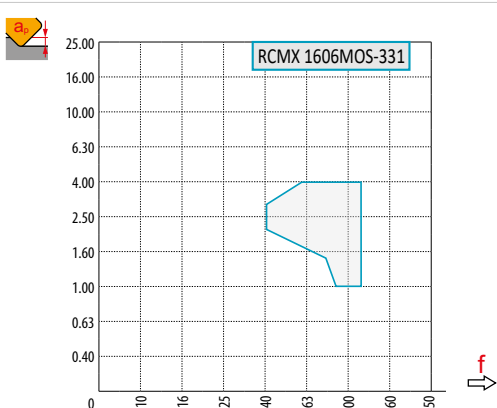
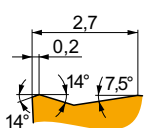

P	M	K	N	S	H
■	■	■	■	■	■
f	0.40 – 1.20				
a_p	1.0 – 4.0				
?	RCMX				

361 (RCMX)

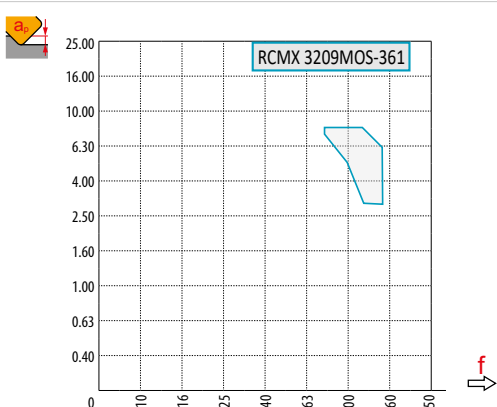
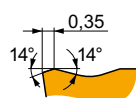



P	M	K	N	S	H
■	■	■	■	■	■
f	0.80 – 1.50				
a_p	3.0 – 8.0				
?	RCMX				

GEOMETRIA DEGLI INSERTI DI TORNITURA POSITIVI – DESIGNAZIONE BLOCCAGGIO ISO P, M, D

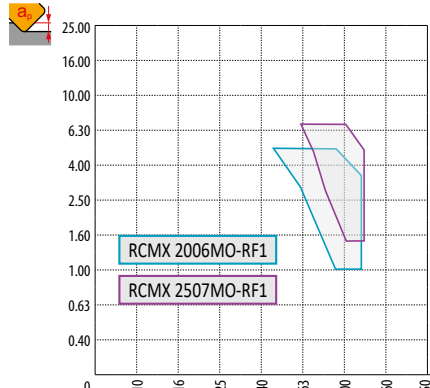

RF1 (RCMX)

P	M	K	N	S	H
■		▣			
f	0.45 (0.60) – 1.20 (1.25)				
ap	1.0 (1.5) – 5.0 (7.0)				
					
					
 RCMX 20, RCMX 25					

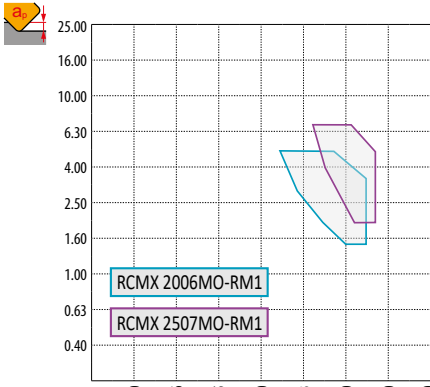

RM1 (RCMX)

P	M	K	N	S	H
■		▣			
f	0.50 (0.70) – 1.30 (1.40)				
ap	1.5 (2.0) – 5.0 (8.0)				
					
					
 RCMX 20, RCMX 25					

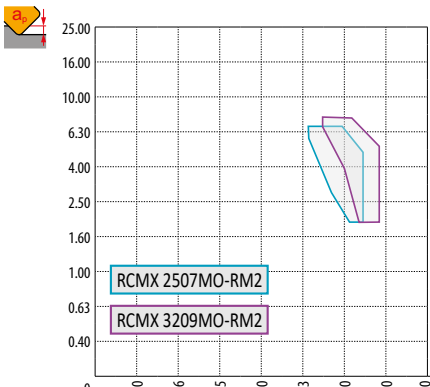

RM2 (RCM.)

P	M	K	N	S	H
■		▣			
f	0.70 (0.80) – 1.30 (1.50)				
ap	2.0 – 7.0 (8.0)				
					
					
 RCMX 25, RCMX 32					

RR2 (RCM.)

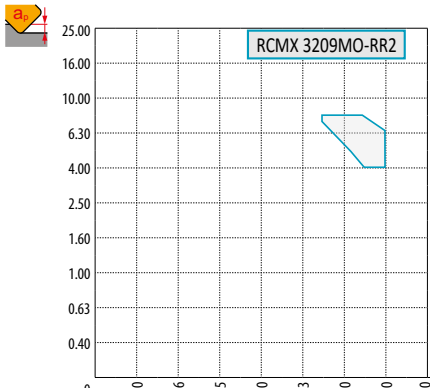
P	M	K	N	S	H
■		■			▣
f	0.80 – 1.60				
ap	4.0 – 8.0				
					
					
 RCMX 32					

GEOMETRIA DEGLI INSERTI DI TORNITURA NEGATIVI – DESIGNAZIONE BLOCCAGGIO ISO P, M, D

000 (LNUX)

P	M	K	N	S	H
■		■			
f	1.20 – 2.50				
a_p	10.0 – 36.0				
?	LNUX 50				

002 (LNUX)

P	M	K	N	S	H
■		■			
f	1.30 – 2.60				
a_p	10.0 – 27.0				
?	LNUX 40				

003 (LNUX)

P	M	K	N	S	H
■		■			
f	1.20 – 2.50				
a_p	10.0 – 27.0				
?	LNUX 40				



08 (RNMG)

P	M	K	N	S	H
▣		▣			▣
f	0.30 – 0.80				
a_p	1.0 – 4.0				
?	RNMG				

GEOMETRIA DEGLI INSERTI DI TORNITURA NEGATIVI – DESIGNAZIONE BLOCCAGGIO ISO P, M, D

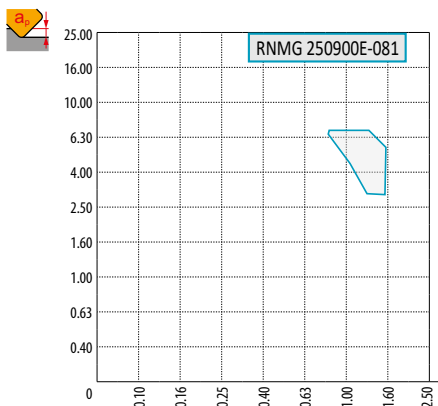

81 (RNMG)

P	M	K	N	S	H
<input checked="" type="checkbox"/>		<input checked="" type="checkbox"/>			<input checked="" type="checkbox"/>
f	0.80 – 1.20				
a_p	3.0 – 7.0				
					
					
?	RNMG				

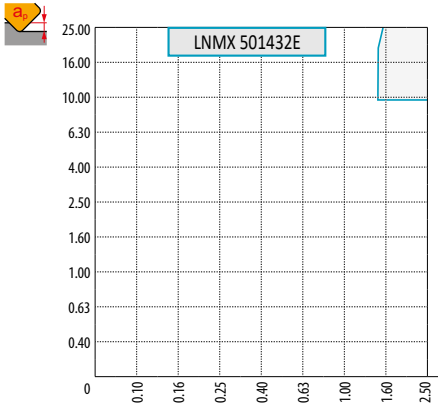

432 (LNMX)

P	M	K	N	S	H
<input checked="" type="checkbox"/>		<input checked="" type="checkbox"/>			
f	1.50 – 2.60				
a_p	10.0 – 35.0				
					
					
?	LNMX 50				

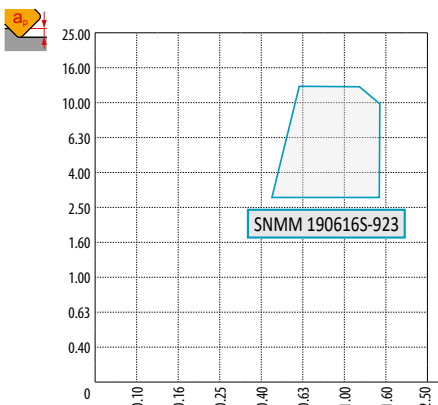

923

P	M	K	N	S	H
<input checked="" type="checkbox"/>	<input checked="" type="checkbox"/>	<input checked="" type="checkbox"/>		<input checked="" type="checkbox"/>	
f	0.45 – 1.50				
a_p	3.0 – 16.0				
					
					
?	CNMM, SNMM				

...A

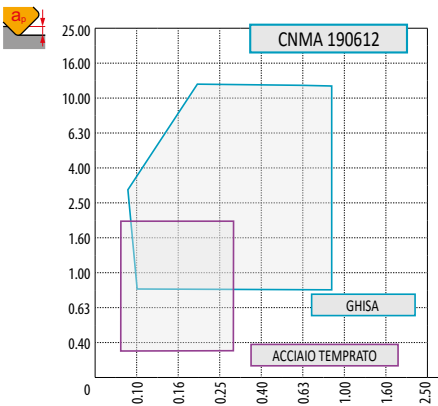



P	M	K	N	S	H
		<input checked="" type="checkbox"/>			<input checked="" type="checkbox"/>
f	0.10 – 1.10				
a_p	0.8 – 12.7				
					
					
?	CNMA, DNMA, SNMA, TNMA, WNMA				

GEOMETRIA DEGLI INSERTI DI TORNITURA NEGATIVI – DESIGNAZIONE BLOCCAGGIO ISO P, M, D

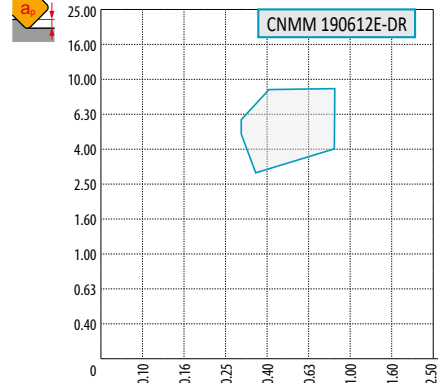

DR

P	M	K	N	S	H
■	▣	▤	■	■	■
f	0.30 – 0.85				
a_p	2.5 – 9.0				
					
					
?	CNMM, DNMM, SNMM, TNMM, WNMM				

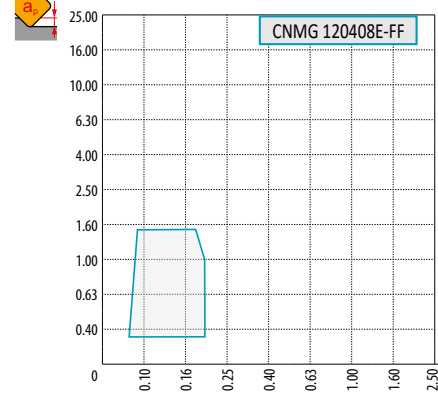

FF

P	M	K	N	S	H
■	■	▤	■	■	■
f	0.06 – 0.25				
a_p	0.2 – 1.6				
					
					
?	CNMG, DNMG, TNMG, VNMG, WNMG				

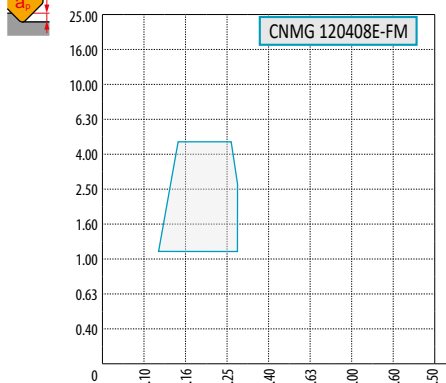

FM

P	M	K	N	S	H
■	▣	■	■	▣	■
f	0.1 – 0.5				
a_p	0.4 – 5.0				
					
					
?	CNMG, DNMG, SNMG, TNMG, VNMG, WNMG				

HR

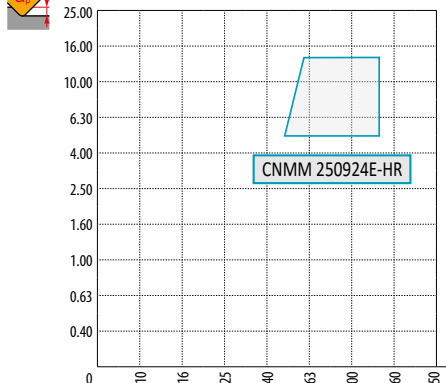



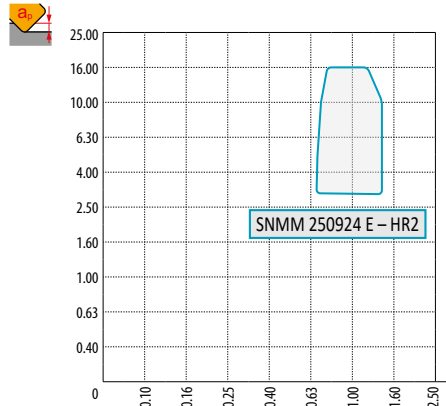

P	M	K	N	S	H
■	▣	■	■	■	■
f	0.50 – 1.40				
a_p	5.0 – 14.0				
					
					
?	CNMM, SNMM, TNMM				

GEOMETRIA DEGLI INSERTI DI TORNITURA NEGATIVI – DESIGNAZIONE BLOCCAGGIO ISO P, M, D



HR2

P	M	K	N	S	H
■	■	■	■	■	■
f		0.5 – 1.4			
a _p		3.0 – 16.0			
					
					
 CNMM, SNMM					

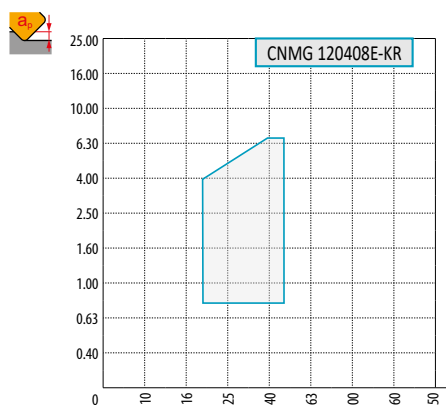

KR

P	M	K	N	S	H
■	■	■	■	■	■
f		0.2 – 0.7			
a _p		0.4 – 7			
					
					
 CNMG, SNMG, TNMG, WNMG					

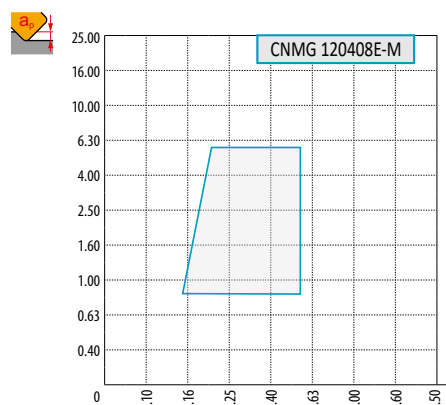

M

P	M	K	N	S	H
■	■	■	■	■	■
f		0.17 – 0.80			
a _p		0.8 – 8.0			
					
					
 CNMG, DNMG, SNMG, TNMG, VNMG, WNMG					

NF

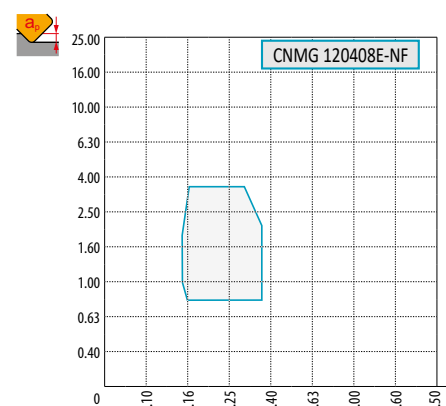
P	M	K	N	S	H
■	■	■	■	■	■
f		0.1 – 0.35			
a _p		0.4 – 4.0			
					
					
 CNMG, DNMG, SNMG, TNMG, VNMG, WNMG					

GEOMETRIA DEGLI INSERTI DI TORNITURA NEGATIVI – DESIGNAZIONE BLOCCAGGIO ISO P, M, D

NM



30° 0.25
10°

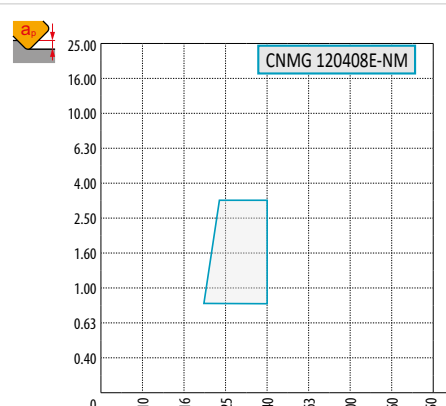

CNMG 120408E-NM

P	M	K	N	S	H
■	■	■	■	■	■
f		0.15 – 0.55			
a _p		0.5 – 8.0			



? CNMG, DNMG, TNMG, VNMG, WNMG

NMR



22° 0.31
10°

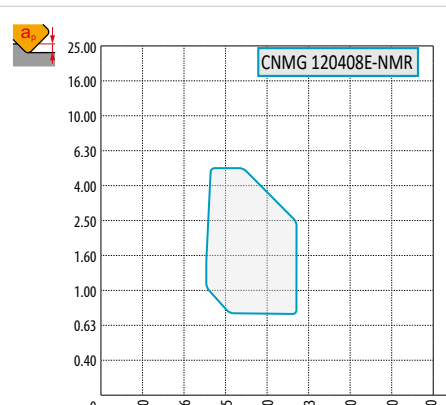

CNMG 120408E-NMR

P	M	K	N	S	H
■	■	■	■	■	■
f		0.18 – 0.70			
a _p		0.4 – 8.0			



? CNMG, DNMG, SNMG, TNMG, VNMG, WNMG

NR



0.25
23°

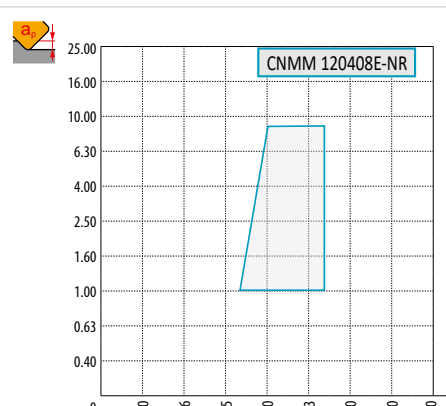

CNMM 120408E-NR

P	M	K	N	S	H
■	■	■	■	■	■
f		0.25 – 0.80			
a _p		1.0 – 9.0			



? CNMM, DNMM, SNMM, TNMM, WNMM

NRM



0.32
6° 24°

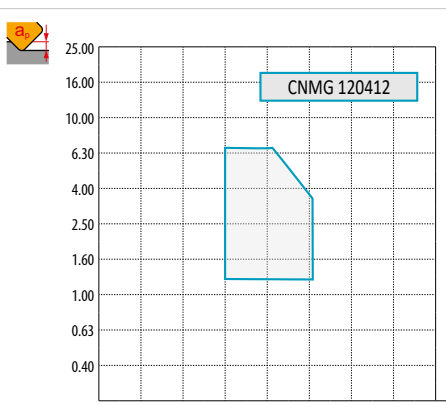

CNMG 120412

P	M	K	N	S	H
■	■	■	■	■	■
f		0.23 – 1.0			
a _p		0.8 – 16.0			



? CNMG, CNMM, SNMG, SNMM

GEOMETRIA DEGLI INSERTI DI TORNITURA NEGATIVI – DESIGNAZIONE BLOCCAGGIO ISO P, M, D

NR2

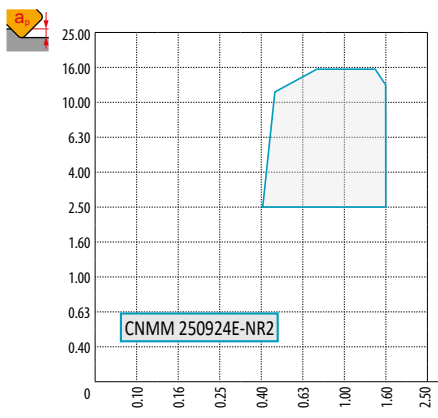
CNMM 250924E-NR2

P	M	K	N	S	H
■	■	▣	■	▣	■
f	0.2 – 1.6				
a_p	1.0 – 16.0				



? CNMM, DNMM, SNMM, TNMM, WNMM

OR

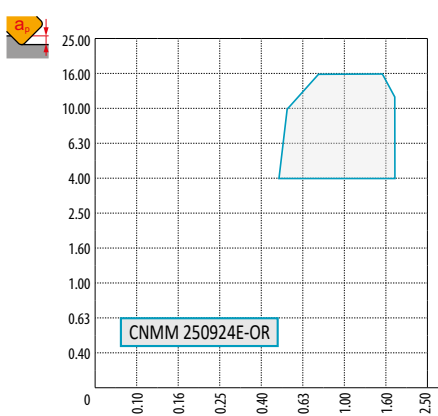
CNMM 250924E-OR

P	M	K	N	S	H
■	▣	■	■	▣	■
f	0.25 – 1.70				
a_p	2.0 – 16.0				



? CNMM, DNMM, SNMM, TNMM, WNMM, SCMT

OR1

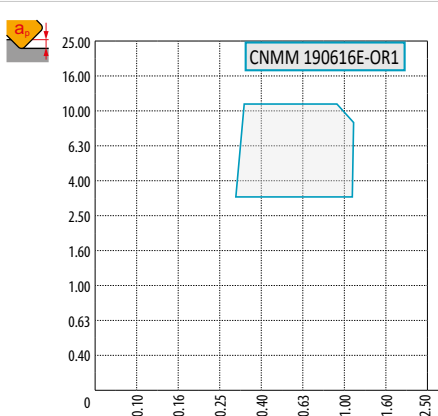
CNMM 190616E-OR1

P	M	K	N	S	H
■	▣	▣	■	▣	■
f	0.3 – 1.0				
a_p	3.0 – 11.0				



? CNMM, SNMM

R

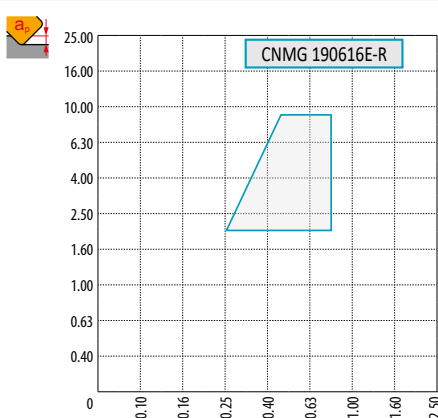
CNMG 190616E-R

P	M	K	N	S	H
■	■	■	■	■	▣
f	0.25 – 0.80				
a_p	2.0 – 9.0				





? CNMG, DNMG, SNMG, TNMG, WNMG

GEOMETRIA DEGLI INSERTI DI TORNITURA NEGATIVI – DESIGNAZIONE BLOCCAGGIO ISO P, M, D

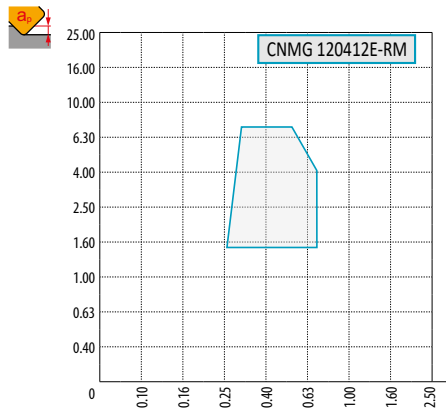

RM

P	M	K	N	S	H
■	■	■	□	□	□
f	0.20 – 1.20				
a_p	1.0 – 15.0				
					
					
?	CNMG, DNMG, SNMG, TNMG, WNMG				

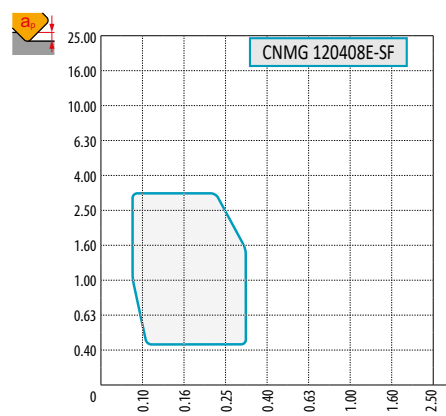

SF

P	M	K	N	S	H
■	■	■	□	■	■
f	0.08 – 0.35				
a_p	0.2 – 3.5				
					
					
?	CNMG, DNMG, SNMG, TNMG, VNMG, WNMG				

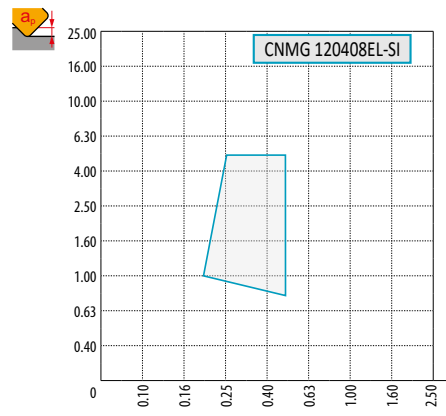

SI

P	M	K	N	S	H
■	■	■	□	□	□
f	0.20 – 0.50				
a_p	0.4 – 5.0				
					
					
?	CNMG, DNMG, TNMG, WNMG				

SM

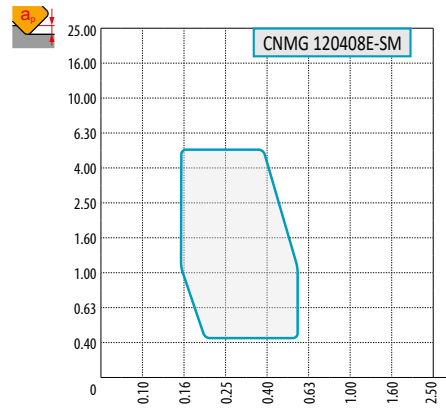



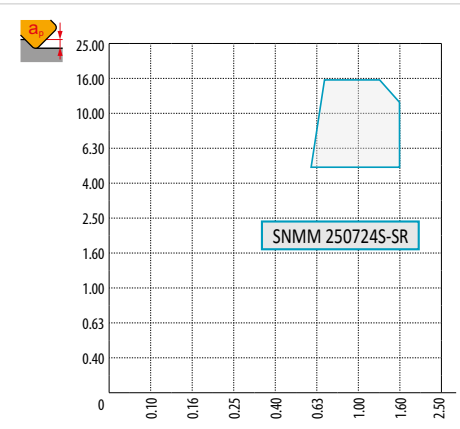

P	M	K	N	S	H
■	■	■	□	■	□
f	0.15 – 0.55				
a_p	0.4 – 6.0				
					
					
?	CNMG, DNMG, SNMG, TNMG, VNMG, WNMG				

GEOMETRIA DEGLI INSERTI DI TORNITURA NEGATIVI – DESIGNAZIONE BLOCCAGGIO ISO P, M, D

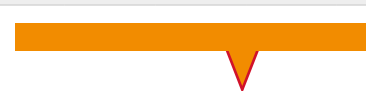

SR

P	M	K	N	S	H
■	▣	■	■	■	■
f 0.70 – 1.60					
a _p 5.0 – 16.0					
					
					
 SNMM, SNMX					

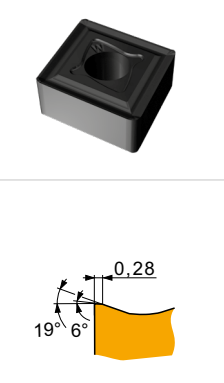
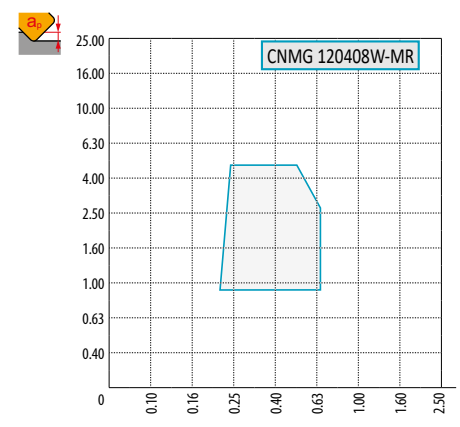

W-MR

P	M	K	N	S	H
■	▣	▣	■	■	■
f 0.2 – 0.75					
a _p 0.5 – 5.0					
					
					
 CNMG, WNMG, DNMG					

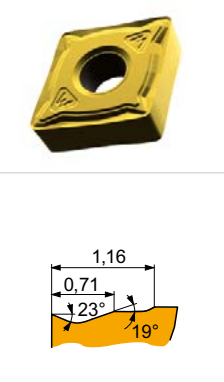
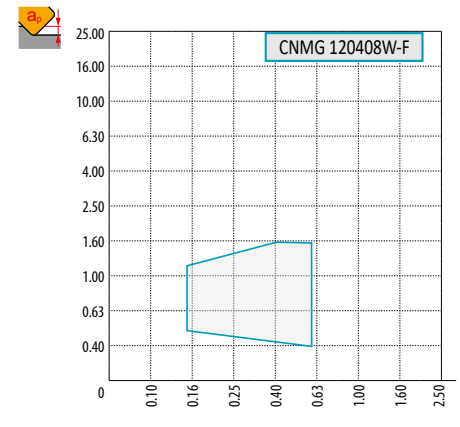

W-F

P	M	K	N	S	H
■	■	■	■	■	■
f 0.10 – 0.60					
a _p 0.4 – 1.6					
					
					
 CNMG, WNMG					

W-M

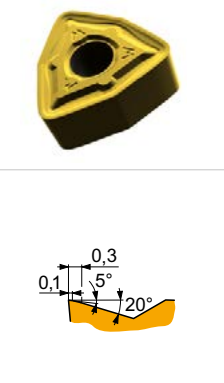
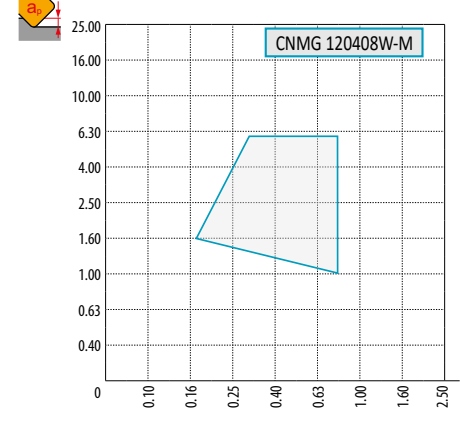
P	M	K	N	S	H
■	■	▣	■	■	■
f 0.15 – 1.00					
a _p 0.8 – 4.0					
					
					
 CNMG, WNMG					







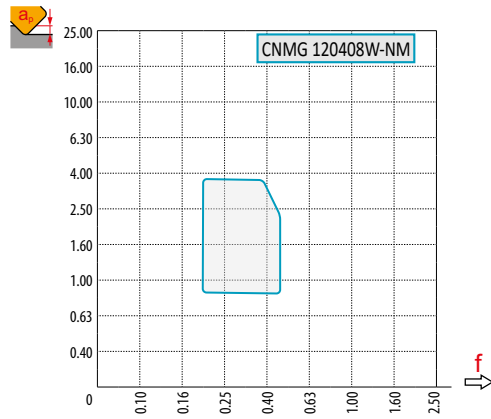
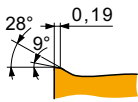

GEOMETRIA DEGLI INSERTI DI TORNITURA NEGATIVI – DESIGNAZIONE BLOCCAGGIO ISO P, M, D

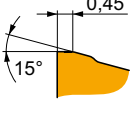
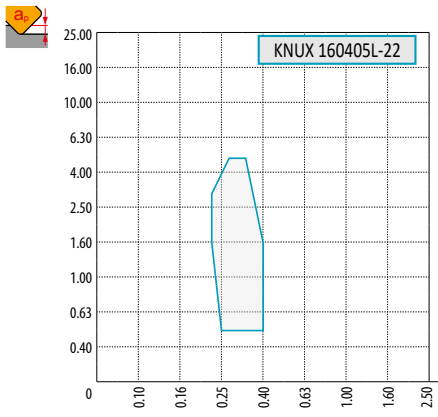
W-NM

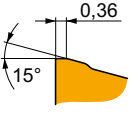
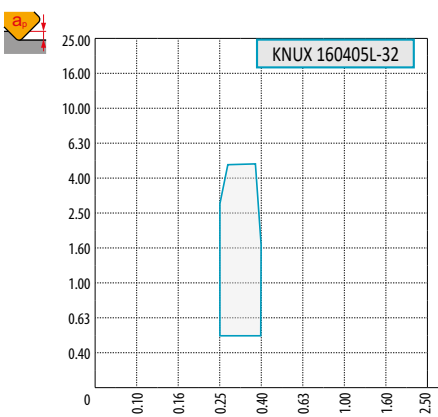

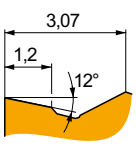
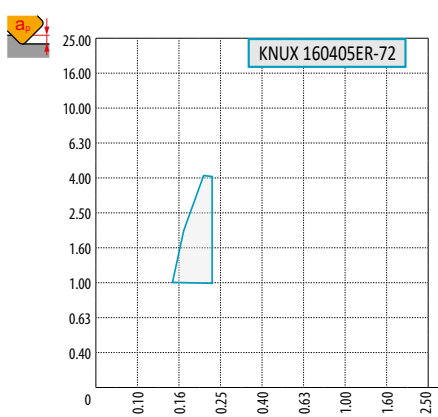
P	M	K	N	S	H
<input type="checkbox"/>	<input checked="" type="checkbox"/>	<input checked="" type="checkbox"/>	<input type="checkbox"/>	<input checked="" type="checkbox"/>	<input type="checkbox"/>
	0.15 – 0.55				
	0.5 – 3.5				
	CNMG, DNMX, WNMG				

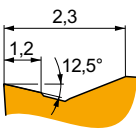
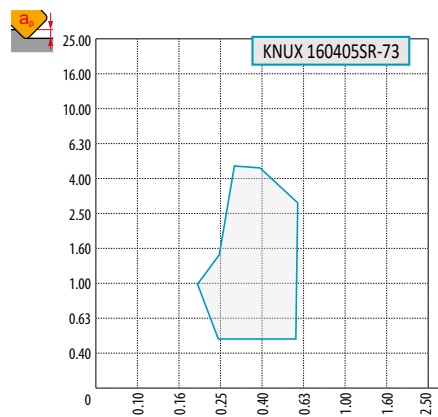
GEOMETRIA DEGLI INSERTI DI TORNITURA NEGATIVI – DESIGNAZIONE BLOCCAGGIO ISO C

22					<table border="1"> <thead> <tr> <th>P</th> <th>M</th> <th>K</th> <th>N</th> <th>S</th> <th>H</th> </tr> </thead> <tbody> <tr> <td>■</td> <td>▣</td> <td>▣</td> <td>■</td> <td>■</td> <td>■</td> </tr> <tr> <td>f</td> <td colspan="5">0.23 – 0.55</td> </tr> <tr> <td>a_p</td> <td colspan="5">0.50 – 4.80</td> </tr> </tbody> </table>	P	M	K	N	S	H	■	▣	▣	■	■	■	f	0.23 – 0.55					a_p	0.50 – 4.80				
	P	M	K	N	S	H																							
■	▣	▣	■	■	■																								
f	0.23 – 0.55																												
a_p	0.50 – 4.80																												
32					<table border="1"> <thead> <tr> <th>P</th> <th>M</th> <th>K</th> <th>N</th> <th>S</th> <th>H</th> </tr> </thead> <tbody> <tr> <td>■</td> <td>▣</td> <td>▣</td> <td>■</td> <td>■</td> <td>■</td> </tr> <tr> <td>f</td> <td colspan="5">0.25 – 0.6</td> </tr> <tr> <td>a_p</td> <td colspan="5">0.50 – 4.80</td> </tr> </tbody> </table>	P	M	K	N	S	H	■	▣	▣	■	■	■	f	0.25 – 0.6					a_p	0.50 – 4.80				
P	M	K	N	S	H																								
■	▣	▣	■	■	■																								
f	0.25 – 0.6																												
a_p	0.50 – 4.80																												
72					<table border="1"> <thead> <tr> <th>P</th> <th>M</th> <th>K</th> <th>N</th> <th>S</th> <th>H</th> </tr> </thead> <tbody> <tr> <td>■</td> <td>▣</td> <td>■</td> <td>■</td> <td>▣</td> <td>■</td> </tr> <tr> <td>f</td> <td colspan="5">0.15 – 0.23</td> </tr> <tr> <td>a_p</td> <td colspan="5">1.0 – 4.0</td> </tr> </tbody> </table>	P	M	K	N	S	H	■	▣	■	■	▣	■	f	0.15 – 0.23					a_p	1.0 – 4.0				
	P	M	K	N	S	H																							
■	▣	■	■	▣	■																								
f	0.15 – 0.23																												
a_p	1.0 – 4.0																												
73					<table border="1"> <thead> <tr> <th>P</th> <th>M</th> <th>K</th> <th>N</th> <th>S</th> <th>H</th> </tr> </thead> <tbody> <tr> <td>■</td> <td>▣</td> <td>■</td> <td>■</td> <td>▣</td> <td>■</td> </tr> <tr> <td>f</td> <td colspan="5">0.20 – 0.60</td> </tr> <tr> <td>a_p</td> <td colspan="5">0.5 – 4.8</td> </tr> </tbody> </table>	P	M	K	N	S	H	■	▣	■	■	▣	■	f	0.20 – 0.60					a_p	0.5 – 4.8				
	P	M	K	N	S	H																							
■	▣	■	■	▣	■																								
f	0.20 – 0.60																												
a_p	0.5 – 4.8																												

GEOMETRIA DEGLI INSERTI DI TORNITURA NEGATIVI – DESIGNAZIONE BLOCCAGGIO ISO C

74

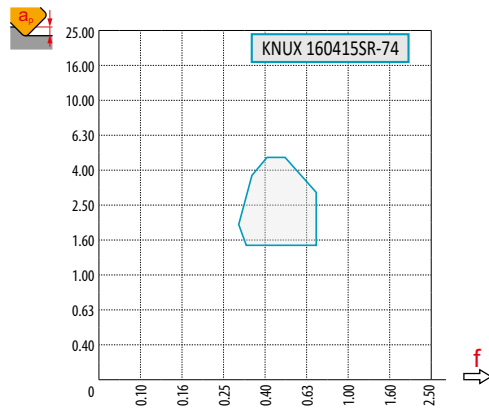
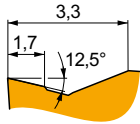

P	M	K	N	S	H
<input type="checkbox"/>	<input checked="" type="checkbox"/>	<input type="checkbox"/>	<input type="checkbox"/>	<input checked="" type="checkbox"/>	<input type="checkbox"/>
	0.30 – 0.7				
	1.5 – 4.8				
	KNUX				

GEOMETRIA DEGLI INSERTI DA SCANALATURA E TAGLIO – DESIGNAZIONE BLOCCAGGIO ISO X E G

GM (GL.D) NEW



20°

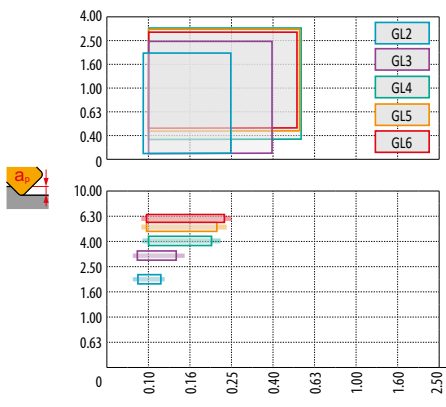

Grade	Depth of Cut (a _p)	Feed (f)
GL2	0.10 - 0.16	0.10 - 0.16
GL3	0.16 - 0.25	0.16 - 0.25
GL4	0.25 - 0.40	0.25 - 0.40
GL5	0.40 - 0.63	0.40 - 0.63
GL6	0.63 - 1.00	0.63 - 1.00

Material	Block
P	■
M	■
K	▣
N	■
S	▣
H	■

Vedere diagramma

GL.D

MM (GL.D) NEW



16° 4°

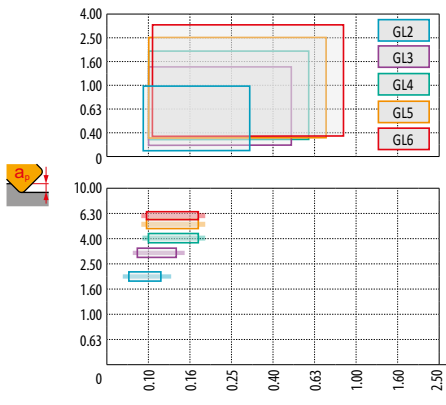

Grade	Depth of Cut (a _p)	Feed (f)
GL2	0.10 - 0.16	0.10 - 0.16
GL3	0.16 - 0.25	0.16 - 0.25
GL4	0.25 - 0.40	0.25 - 0.40
GL5	0.40 - 0.63	0.40 - 0.63
GL6	0.63 - 1.00	0.63 - 1.00

Material	Block
P	■
M	■
K	▣
N	■
S	▣
H	■

Vedere diagramma

GL.D

PM (GL.D) NEW



27° 3°

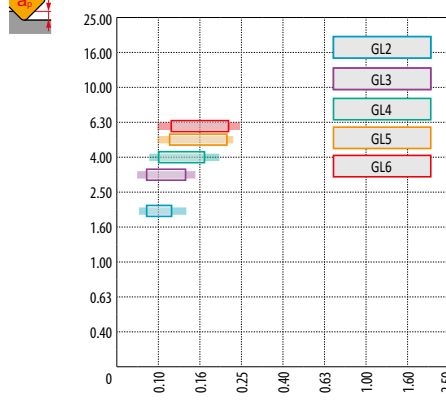

Grade	Depth of Cut (a _p)	Feed (f)
GL2	0.10 - 0.16	0.10 - 0.16
GL3	0.16 - 0.25	0.16 - 0.25
GL4	0.25 - 0.40	0.25 - 0.40
GL5	0.40 - 0.63	0.40 - 0.63
GL6	0.63 - 1.00	0.63 - 1.00

Material	Block
P	■
M	■
K	▣
N	■
S	▣
H	■

Vedere diagramma

GL.D

PR (GL.D) NEW



30° 12°

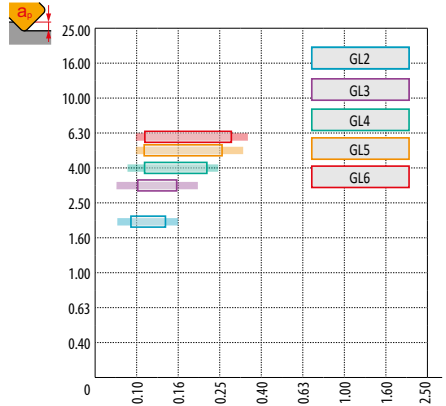

Grade	Depth of Cut (a _p)	Feed (f)
GL2	0.10 - 0.16	0.10 - 0.16
GL3	0.16 - 0.25	0.16 - 0.25
GL4	0.25 - 0.40	0.25 - 0.40
GL5	0.40 - 0.63	0.40 - 0.63
GL6	0.63 - 1.00	0.63 - 1.00

Material	Block
P	■
M	▣
K	■
N	■
S	■
H	■



Vedere diagramma

GL.D

GEOMETRIA DEGLI INSERTI DA SCANALATURA E TAGLIO – DESIGNAZIONE BLOCCAGGIO ISO X E G

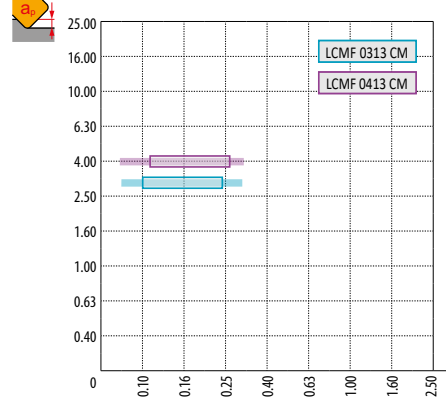

13 CM (LCMF)

P	M	K	N	S	H
■		▣			
f → a _p ↓ Vedere diagramma					
					
					
? LCMF 13 CM					

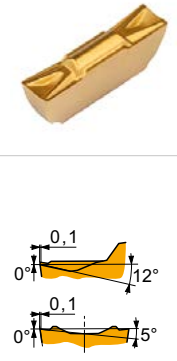
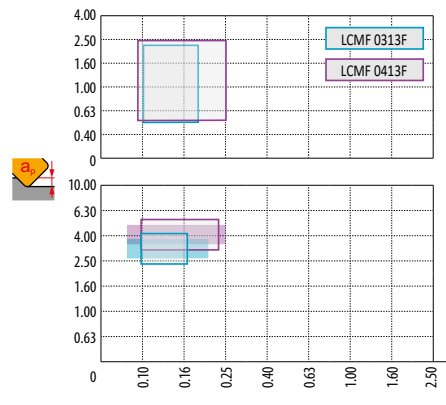

13 F (LCM.)

P	M	K	N	S	H
■		▣			
f → a _p ↓ Vedere diagramma					
					
					
? LCMF 13 F, LCMR 13 F					

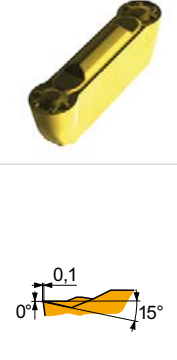
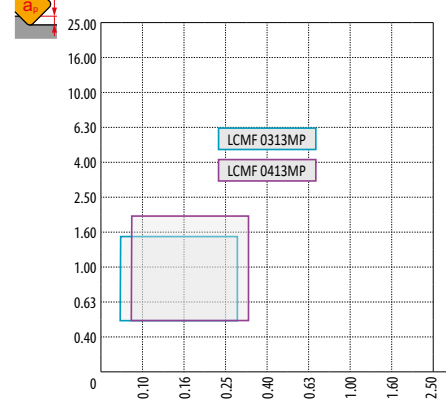

13 MP (LCM.)

P	M	K	N	S	H
■		■			
f → a _p ↓ Vedere diagramma					
					
					
? LCMF 13 MP, LCMR 13 MP					

16 CM (LCM.)

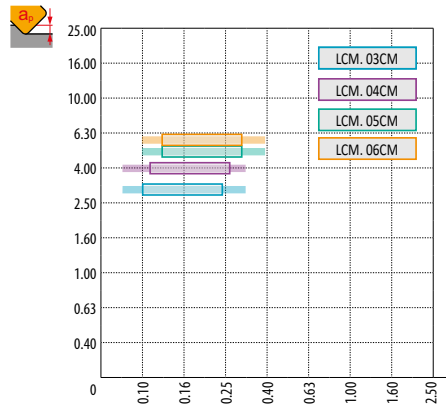
P	M	K	N	S	H
■		▣			
f → a _p ↓ Vedere diagramma					
					
					
? LCMF 16 CM, LCMR 16 CM					

GEOMETRIA DEGLI INSERTI DA SCANALATURA E TAGLIO – DESIGNAZIONE BLOCCAGGIO ISO X E G

16 F (LCM.)

P	M	K	N	S	H
■		■			

Vedere diagramma

LCMF 16 F, LCMR 16 F

16 M (LCM.)

P	M	K	N	S	H
■		■			■

Vedere diagramma

LCMF 16 M, LCMR 16 M

16 MP (LCM.)

P	M	K	N	S	H
■		■			

Vedere diagramma

LCMF 16 MP, LCMR 16 MP

20 F1 (LCMF)

P	M	K	N	S	H
■	■	■			

Vedere diagramma

LCMF

GEOMETRIA DEGLI INSERTI DA SCANALATURA E TAGLIO – DESIGNAZIONE BLOCCAGGIO ISO X E G

20 M2 (LCMF)

P	M	K	N	S	H
■	▣	▣	■	■	■
f	0.09 – 0.23				
a_p	0.3 – 1.5				

? LCMF

30 F (LCM.)

P	M	K	N	S	H
■	■	▣	■	■	■
f	0.1 – 0.5				
a_p	0.8 – 6.0				

? LCMF 30 F, LCMR 30 F

F1 (LFMX)

P	M	K	N	S	H
■	▣	■	■	■	■
f	Vedere diagramma				
a_p	Vedere diagramma				

? LFMX

F2 (LFMX)

P	M	K	N	S	H
■	▣	■	■	■	■
f	Vedere diagramma				
a_p	Vedere diagramma				

? LFMX

GEOMETRIA DEGLI INSERTI DA SCANALATURA E TAGLIO – DESIGNAZIONE BLOCCAGGIO ISO X E G

M2 (LFMX)

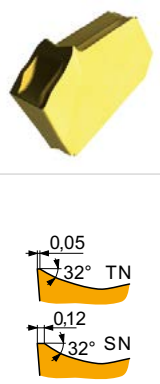

0,05
32° TN
0,12
32° SN

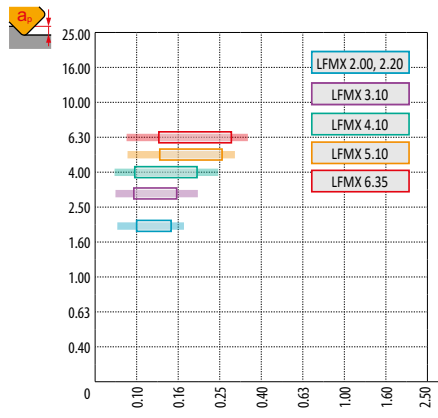

25.00
16.00
10.00
6.30
4.00
2.50
1.60
1.00
0.63
0.40
0

0.10 0.16 0.25 0.40 0.63 1.00 1.60 2.50

LFMX 2.00, 2.20
LFMX 3.10
LFMX 4.10
LFMX 5.10
LFMX 6.35

v
 f

P	M	K	N	S	H
■	■	■			
Vedere diagramma					
					
? LFMX					

LFUX



0,1
5°
15°
R

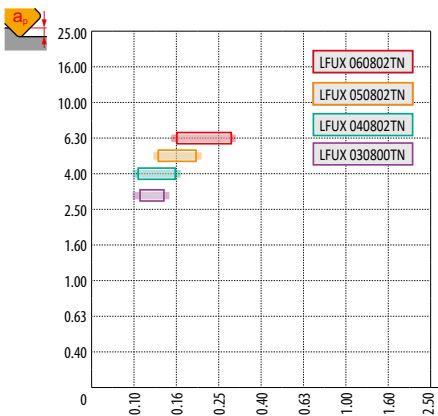

25.00
16.00
10.00
6.30
4.00
2.50
1.60
1.00
0.63
0.40
0

0.10 0.16 0.25 0.40 0.63 1.00 1.60 2.50

LFUX 060802TN
LFUX 050802TN
LFUX 040802TN
LFUX 030800TN

v
 f

P	M	K	N	S	H
■		■			
Vedere diagramma					
					
? LFUX					

GEOMETRIA DEGLI INSERTI DA SCANALATURA SEEGER – DESIGNAZIONE BLOCCAGGIO ISO S

TN. EXT

10°

P	M	K	N	S	H
■	▣	▣	■	■	■

f
→

CW

Vedere diagramma

? TN R EXT; TN ZZ EXT

TN. INT

15°

P	M	K	N	S	H
■	▣	▣	■	■	■

f
→

CW

Vedere diagramma

? TN R INT; TN ZZ INT

X61 NEW

0.13
14°

P	M	K	N	S	H
■	▣	▣	■	■	■

f
→

CW

Vedere diagramma

? X61; X61-1

X61 R NEW

13°

P	M	K	N	S	H
■	▣	▣	■	■	■

f
→

CW

Vedere diagramma

? X61 R; X61 R-1

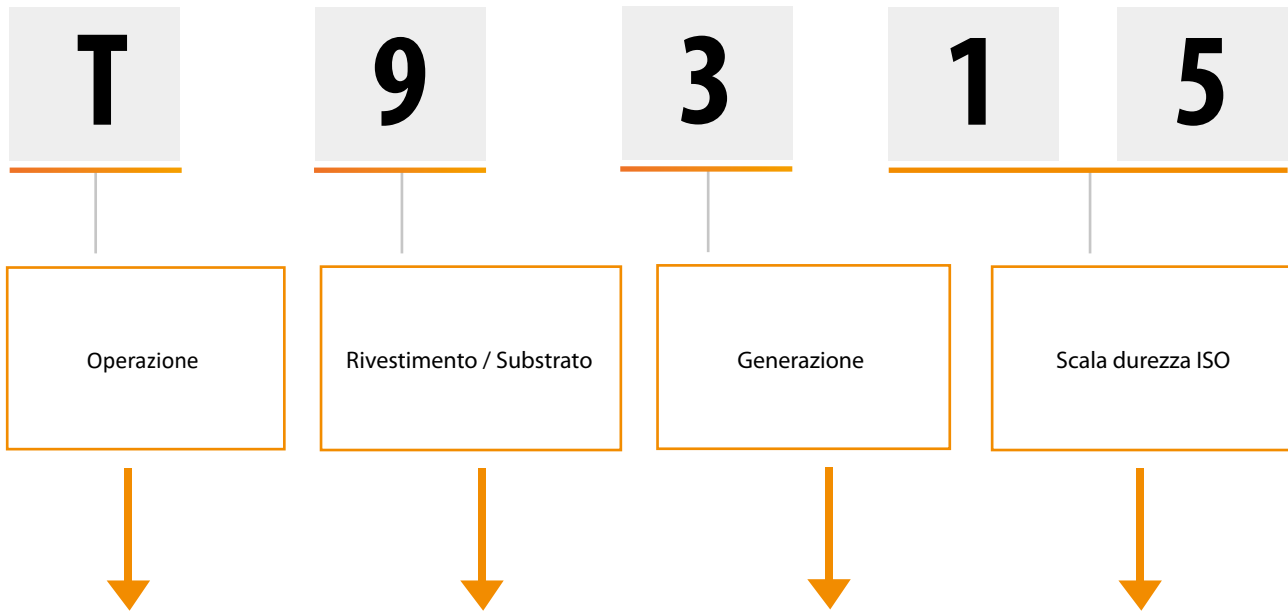

D	Foratura
M	Fresatura
T	Tornitura
G	Scanalatura e Troncatura

0 PVD 1 CVD	Applicazione speciale
2 PVD 3 CVD	Libero
4 PVD 5 CVD	Gruppo K, H
6 PVD 7 CVD	Gruppo M,S
8 PVD 9 CVD	Universale
B	CBN
C	Ceramico
D	PKD
T	Cermet

1 - 9

01 - 50	
	01 - 05
	05 - 10
	10 - 20
	20 - 30
	30 - 40
	40 - 50

QUALITÀ DI TORNITURA

Identificazione della qualità	Area di applicazione	Applicazione	Avanzamento	Velocità di taglio	Resistenza a condizioni di lavoro avverse	Rivestimento	Colore	Substrato	Vantaggio refrigerante	Descrizione della qualità
T9226	P15 - P35	■				MT-CVD	■	FGM	+++	Qualità concepita per applicazioni di sgrossatura gravose. Una qualità versatile con elevata resistenza ai danni meccanici e che mantiene un'ottima resistenza all'usura. Utilizzabile a velocità di taglio minori.
	M10 - M30	■								
	K15 - K35	■								
	S15 - S25	□								
T9310	P01 - P15	■				MT-CVD	■	FGM	++	Qualità con elevata resistenza all'abrasione, utilizzabile per taglio leggermente interrotto. Sarà impiegata per operazioni di finitura e semi sgrossatura. Questo materiale può essere usato anche per operazioni di sgrossatura, a patto che la configurazione del pezzo dell'utensile sia sufficientemente rigida.
	K05 - K20	■								
	H10 - H20	■								
T9315	P05 - P25	■				MT-CVD	■	FGM	++	Una qualità versatile con eccellenti proprietà di resistenza all'usura anche in condizioni di taglio intense. Si può utilizzare anche per operazioni con tagli interrotti. Grazie alle sue proprietà ben bilanciate, questa qualità può essere la prima scelta per un'ampia gamma di operazioni di tornitura. Non adatta a basse velocità di taglio.
	K05 - K25	■								
	H10 - H20	■								
T9316	P10 - P20	■				MT-CVD	■	FGM	+++	Qualità concepita per applicazioni nel settore ferroviario. Una qualità versatile con eccellenti proprietà di resistenza all'usura. Utilizzabile a velocità di taglio basse ed elevate.
	M05 - M15	■								
	K10 - K30	■								
T9325	P15 - P35	■				MT-CVD	■	FGM	++	Dal punto di vista tecnologico, si tratta di una qualità estremamente versatile con un'elevata resistenza al danneggiamento meccanico in condizioni di taglio avverse e che conserva una resistenza all'usura eccellente. La corretta applicazione di questo materiale richiede elevate velocità di taglio.
	M10 - M30	■								
	K15 - K35	■								
T9335	P20 - P45	■				MT-CVD	■	FGM	+++	Una delle qualità più tenaci, particolarmente idonea per condizioni di taglio avverse con ritmi di avanzamento da medi a elevati e velocità di taglio medie. Rispetto ai suoi predecessori, M15 - M40 non soltanto è più tenace, ma anche più resistente all'abrasione, caratteristica utile quando si applicano condizioni di taglio intense.
	M15 - M40	■								
	S15 - S25	■								
T7325	P15 - P35	■				MT-CVD	■	FGM	+++	Una delle qualità di tornitura più universali. Concepita appositamente per la lavorazione di acciaio inossidabile. Equilibrio ottimale tra resistenza all'usura e affidabilità operativa. Adatta per un'ampia varietà di applicazioni nelle operazioni di tornitura.
	M10 - M25	■								
	S10 - S25	■								
T7335	P20 - P40	■				MT-CVD	■	FGM	+++	Qualità con substrato a gradiente funzionale, caratterizzata da un'affidabilità operativa estremamente elevata e una resistenza all'usura molto buona. È perfetta da usare nella lavorazione di materiali molto tenaci M20 - M40.
	M20 - M40	■								
	S15 - S25	■								
T5305	P05 - P15	■				MT-CVD	■	H	+	Qualità con resistenza molto elevata all'usura chimica; idonea per operazioni di finitura con applicazione di velocità di taglio elevate. Grazie alla sua elevata resistenza all'abrasione, è idonea anche per la lavorazione produttiva K01 - K15 di materiali trattati e temprati.
	K01 - K15	■								
	H05 - H15	■								
T5315	P10 - P25	■				MT-CVD	■	H	+	Qualità destinata principalmente alla lavorazione produttiva, con un'elevata resistenza all'abrasione e buona affidabilità operativa. Date le sue caratteristiche, questo materiale è particolarmente idoneo per operazioni di finitura e sgrossatura in presenza di condizioni di taglio buone o leggermente avverse.
	K10 - K25	■								
	H15 - H25	■								
6640	P20 - P40	■				MT-CVD	■	H	+++	Uno dei materiali di tornitura più tenaci che può essere impiegato, specialmente nelle operazioni di sgrossatura, oppure nei casi in cui l'affidabilità operativa in condizioni di taglio avverse rappresenta una priorità. Un'altra scelta ideale per macchine che operano con velocità di taglio da basse a medie e ritmi di avanzamento da medi ad alti.
	M20 - M35	■								
	K25 - K40	■								

QUALITÀ DI TORNITURA

Identificazione della qualità	Area di applicazione	Applicazione	Avanzamento	Velocità di taglio	Resistenza a condizioni di lavoro avverse	Rivestimento	Colore	Substrato	Vantaggio refrigerante	Descrizione della qualità
G8330	P25 - P40	■				PVD	■	submicron H	+++	Qualità di taglio universale per applicazioni di scanalatura e troncatura. Questa qualità è caratterizzata dalla sua eccezionale affidabilità e versatilità. Sviluppata per adattarsi alle condizioni di lavorazione per la maggior parte dei materiali dei pezzi da lavorare.
	M20 - M35	■	▴	▴	▴					
	K20 - K40	■	▴	▴	▴					
	S15 - S25	■	▴	▴	▴					
T0315	N05 - N20	■	▴	▴	▴	PVD	■	submicron H	++	Qualità submicronica per la tornitura di metalli non ferrosi e delle rispettive leghe con un equilibrio tra resistenza all'usura e tenacità. È dotata di un rivestimento esclusivo con eccellenti caratteristiche di attrito.
T6310	P01 - P15	■				PVD	■	ultra submicron H	+++	Qualità di tornitura ad alta resistenza all'usura con rivestimento PVD superiore. Adatta per operazioni di finitura e applicazioni, dove il tagliente affilato insieme a un'elevata resistenza all'usura sul fianco è di grande importanza
	M01 - M15	■								
	K05 - K20	■	▴	▴	▴					
	N05 - N20	■	▴	▴	▴					
	S01 - S15	■	▴	▴	▴					
	H01 - H15	■	▴	▴	▴					
T8010	P05 - P15	■				PVD	■	submicron H	+++	Questa qualità è adatta per la tornitura di filetti continua ad alta precisione di acciai, acciai inossidabili, ghise e superleghe. Offre un'eccellente resistenza all'usura assicurando l'affidabilità operativa
	M05 - M15	■	▴	▴	▴					
	K10 - K20	■	▴	▴	▴					
	S10 - S15	■	▴	▴	▴					
T8030	P25 - P40	■				PVD	■	submicron H	+++	Indubbiamente la qualità più versatile, è adatta alla lavorazione di tutti i tipi di materiali lavorati ed è applicabile a quasi tutte le operazioni di tornitura. I suoi principali vantaggi sono l'elevata affidabilità operativa e le eccellenti proprietà di attrito; è quindi adatta ad applicazioni a velocità di taglio medio basse.
	M20 - M35	■	▴	▴	▴					
	K20 - K40	■	▴	▴	▴					
	N15 - N30	■	▴	▴	▴					
	S15 - S25	■	▴	▴	▴					
T8315	P05 - P20	■				PVD	■	submicron H	++	Qualità caratterizzata da un'eccellente resistenza all'abrasione pur mantenendo un'affidabilità operativa superiore alla media, è adatta per lavorazioni a velocità di taglio medio-alte in materiali più duri a truciolo corto.
	M05 - M20	■								
	K05 - K25	■	▴	▴	▴					
	N05 - N25	■	▴	▴	▴					
	S05 - S15	■	▴	▴	▴					
	H05 - H15	■	▴	▴	▴					
T8330	P25 - P40	■				PVD	■	submicron H	+++	Indubbiamente, il materiale di taglio più versatile, è utile per la lavorazione di tutti i tipi di materiali lavorati ed è applicabile a quasi tutti i tipi di operazioni di tornitura. I suoi principali vantaggi sono l'elevata affidabilità operativa e caratteristiche di attrito molto buone; è pertanto idoneo per applicazioni a velocità di taglio medie e più basse.
	M20 - M35	■	▴	▴	▴					
	K20 - K40	■	▴	▴	▴					
	N15 - N30	■	▴	▴	▴					
	S15 - S25	■	▴	▴	▴					
	H15 - H25	■	▴	▴	▴					
T8430 NEW	P20 - P40	■				PVD	■	submicron H	+++	Indubbiamente, il materiale di taglio più versatile, è utile per la lavorazione di tutti i tipi di materiali lavorati ed è applicabile a quasi tutti i tipi di operazioni di tornitura. I suoi principali vantaggi sono l'elevata affidabilità operativa e caratteristiche di attrito molto buone; è pertanto idoneo per applicazioni a velocità di taglio medie e più basse.
	M20 - M35	■	▴	▴	▴					
	K25 - K40	■	▴	▴	▴					
	N15 - N30	■	▴	▴	▴					
	S15 - S25	■	▴	▴	▴					
	H15 - H25	■	▴	▴	▴					
T8345	P30 - P50	■				PVD	■	submicron H	+++	È la qualità di tornitura più tenace, destinata principalmente alla lavorazione in condizioni di taglio pessime e nell'ambito di applicazioni con le più alte esigenze di affidabilità operativa. Date queste caratteristiche, questo materiale è consigliato per velocità di taglio più basse.
	M20 - M40	■	▴	▴	▴					
	K30 - K40	■	▴	▴	▴					
	S20 - S30	■	▴	▴	▴					
HF7	M10 - M20	■				×	■	submicron H	++	Qualità non rivestita, progettata principalmente per la lavorazione di metalli non ferrosi; ma può essere utilizzata anche per altri materiali lavorati (tranne l'acciaio). Questo materiale può essere impiegato per tornitura, fresatura e persino alesatura.
	K10 - K25	■	▴	▴	▴					
	N10 - N25	■	▴	▴	▴					

QUALITÀ DI TORNITURA

Identificazione della qualità	Area di applicazione	Applicazione	Avanzamento	Velocità di taglio	Resistenza a condizioni di lavoro avverse	Rivestimento	Colore	Substrato	Vantaggio refrigerante	Descrizione della qualità
H07	M05 - M15	<input checked="" type="checkbox"/>				×		submicron H	++	Qualità di tornitura non rivestita adatta in applicazioni di lavorazione dove la resistenza all'ossidazione non è il criterio dominante della vita utensile. Concepita per la lavorazione di leghe a base di titanio. La qualità mostra un'elevata resistenza del tagliente insieme a una buona resistenza all'usura.
	K10 - K25	<input checked="" type="checkbox"/>								
	N10 - N30	<input checked="" type="checkbox"/>								
	S01 - S20	<input checked="" type="checkbox"/>								
TT310	P10 - P25	<input checked="" type="checkbox"/>				PVD		cermet	+ / -	Cermet rivestito utilizzato per la tornitura di finitura e fine degli acciai a contenuto di carbonio e legati (compreso l'acciaio inossidabile). Le sue eccellenti caratteristiche di attrito sono ulteriormente migliorate dal rivestimento applicato con la tecnica PVD.
	M15 - M25	<input checked="" type="checkbox"/>								
TT010	P01 - P10	<input checked="" type="checkbox"/>				×		cermet	+ / -	Cermet non rivestito, idoneo per la lavorazione fine di tutti i tipi di acciaio (incluso l'acciaio inossidabile) a ritmi di avanzamento molto bassi. Il suo vantaggio principale è il raggio minimo del tagliente e la sua elevata resistenza ai meccanismi fisici e chimici di usura.
	M01 - M10	<input checked="" type="checkbox"/>								
TC100	K01 - K15	<input checked="" type="checkbox"/>				×		ceramics	--	Qualità ceramica per la lavorazione della ghisa. Adatta per lavorare con velocità di taglio elevata in condizioni stabili.
TB310	K01 - K10	<input checked="" type="checkbox"/>				×		CBN	--	Qualità CBN per la lavorazione di materiali temprati. Adatta per lavorare con velocità di taglio elevate e piccoli avanzamenti in condizioni stabili.
	S05 - S10	<input checked="" type="checkbox"/>								
	H01 - H10	<input checked="" type="checkbox"/>								
PD1	N05 - N25	<input checked="" type="checkbox"/>				×		PCD	-	Qualità PKD per la tornitura di metalli non ferrosi. Scelta ideale per lavorare con velocità di taglio elevate e piccoli avanzamenti in condizioni stabili.
333TN	P45 - P50	<input checked="" type="checkbox"/>				PVD		HSS	+++	Qualità speciale composta da substrato HSS e rivestimento PVD sottile e duro. La qualità di taglio più tenace del portafoglio. Gli inserti con questa qualità sono unici e vengono utilizzati solo in operazioni di strozzatura per scanalature di chiavette.
	M35 - M40	<input checked="" type="checkbox"/>								
	K35 - K40	<input checked="" type="checkbox"/>								

Substrato	
H	Substrato in base WC-Co
submicron H	Substrato in base WC-Co a grana fine (< 1 µm)
ultra submicron H	Substrato in base WC-Co a grana finissima (< 0,5 µm)
FGM	Substrato a gradiente funzionale
Cermet	Carburo cementato senza WC
ceramics	Ceramico
PCD	Diamante policristallino
CBN	Nitrato cubico di boro
HSS	Acciaio super rapido

Rivestimento	
MT-CVD	Rivestimento chimico a media temperatura
PVD	Rivestimento fisico a media temperatura
×	Qualità non rivestita

Benefici del liquido da taglio	
+++	L'utilizzo del refrigerante è essenziale
++	Estremamente raccomandato
+	Raccomandato
+ / -	Facoltativo
--	Non utilizzare refrigerante
-	Refrigerante non raccomandato

INSERTI IN CERAMICA E RISPETTIVE APPLICAZIONI PRATICHE

T01020 ⇒

Preparazione tagliente

BN (BN2)

GB (BN1 × GB1 dipende da BN2 × GB2)

Esempio: **CNGA 120404 T02020** – Insetto CNGA con pianetto (rinforzo tipo T) larghezza 0,2mm ed angolo -20°

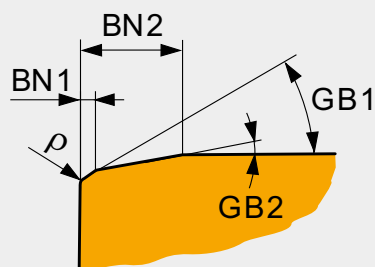
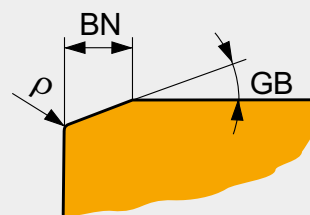

Le ceramiche da taglio sono materiali che possiedono uno dei più elevati limiti di stabilità termica.

Durante il loro uso pratico, tuttavia, occorre anche ridurre la velocità di taglio in funzione della durezza e delle altre proprietà del materiale lavorato.

A titolo illustrativo, forniamo un esempio concreto per un inserto circolare usato per la tornitura di finitura.

Velocità di taglio per RNGN ($a_p = 1.5 \text{ mm}$)

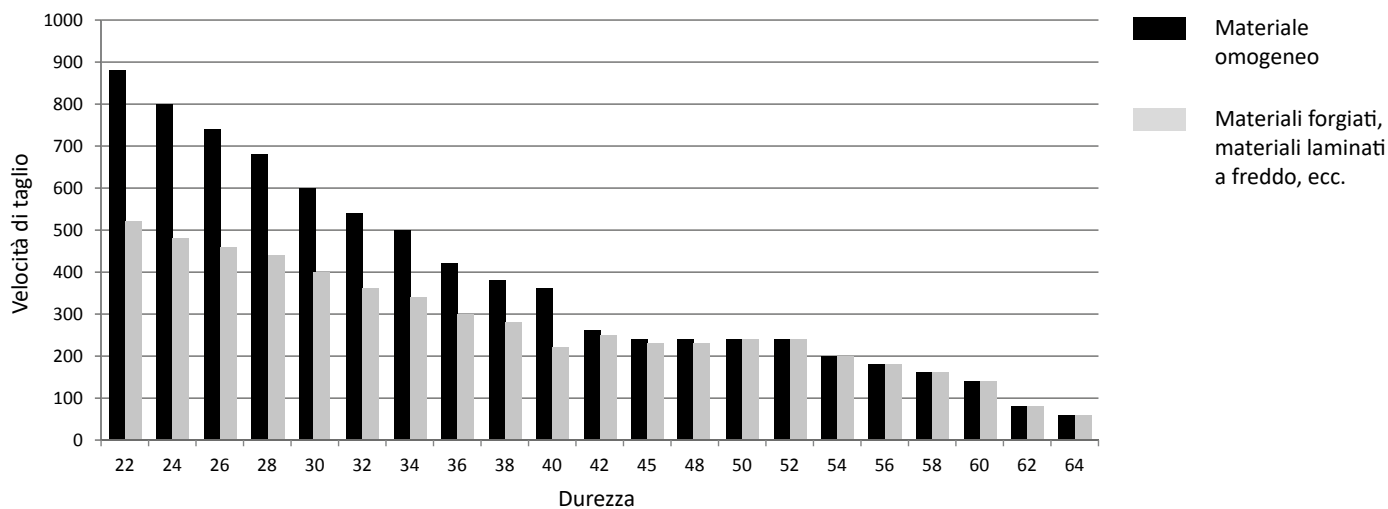

La tabella seguente indica altri parametri da tenere presente nella scelta della velocità di taglio risultante.

Raggio di punta RE [mm]	0.4	0.8	1.2	1.6	2.4	3
Riduzione v_c del	20 %	16 %	12 %	10 %	5 %	2 %
Angolo tagliente principale	90°	75°	60°	45°	30°	< 15°
Riduzione v_c del	0 %	5 %	8 %	12 %	15 %	18 %
Forma dell'inserto	V	D	T	C, W	S	R
Angolo di punta	35°	55°	60°	80°	90°	–
Riduzione v_c del	17 %	12 %	10 %	6 %	4 %	0 %
Profondità di taglio a_p [mm]	<1.4	3	6	10	13	20
Riduzione v_c del	5 %	8 %	13 %	16 %	18 %	20 %

INSERTI IN CERAMICA E RISPETTIVE APPLICAZIONI PRATICHE

Come già citato, le ceramiche da taglio sono materiali che possiedono uno dei più elevati livelli di resistenza all'abrasione, tuttavia, al tempo stesso, sono caratterizzate da uno dei più bassi livelli di tenacità.

Dal punto di vista della rigidità, pertanto, occorre tenere conto anche di altri criteri di limitazione nella scelta dell'inserto corretto.

Rigidità in relazione alla forma dell'inserto

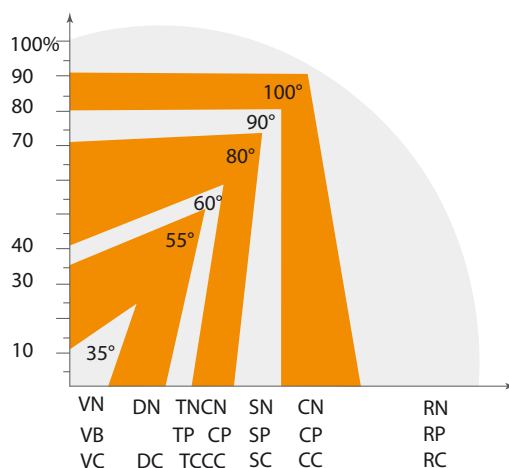

Rigidità in relazione allo spessore dell'inserto

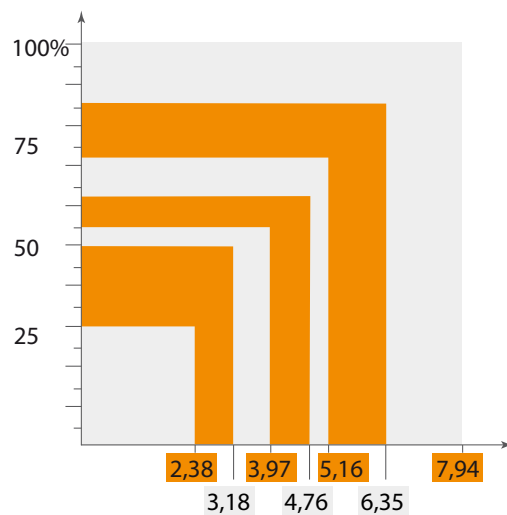

Rigidità in relazione al raggio dell'inserto

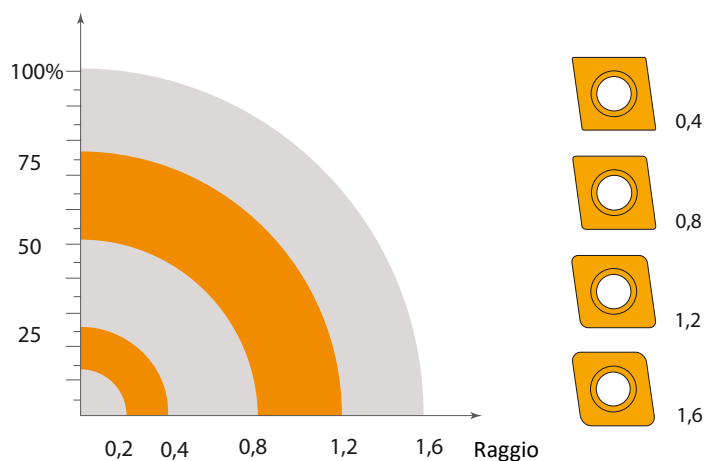

INSERTI IN CERAMICA E RISPETTIVE APPLICAZIONI PRATICHE

Infine, desideriamo fornire alcune raccomandazioni per l'applicazione pratica:

1) Le bave all'uscita dell'utensile possono provocare scheggiature del tagliente e il danneggiamento dell'intero inserto. Pertanto, è necessario, per prima cosa, smussare il pezzo per eliminare le bave.

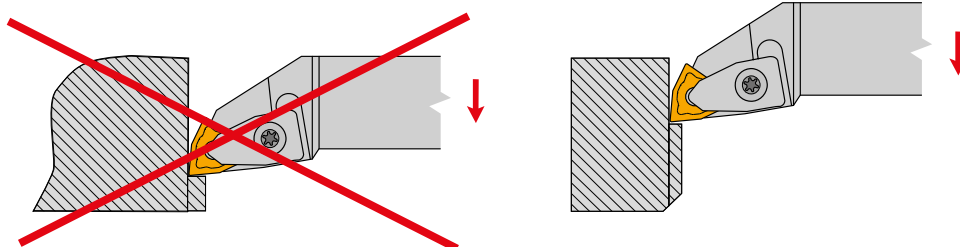

2) Si raccomanda di modificare il programma standard (ingresso nel materiale); questo riduce la formazione di bave sul tagliente, allungandone la durata; in questo modo, anche l'operazione di smussare il pezzo viene eliminata.

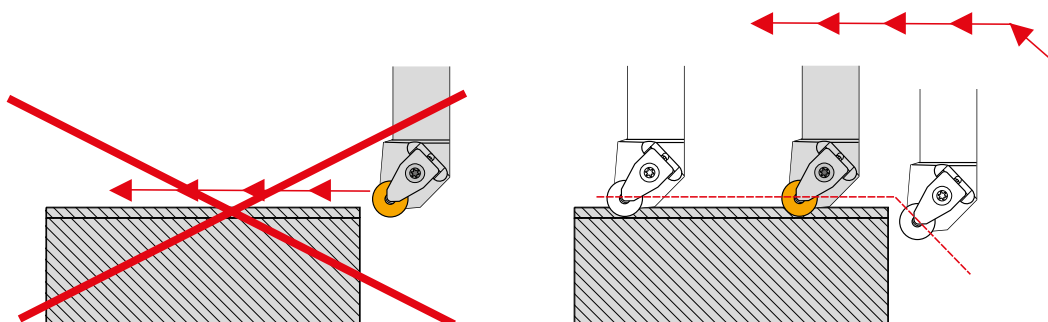

3) Se vi è un rischio di problemi legati alla vibrazione dell'utensile, è opportuno usare inserti con un raggio minore per eliminare le forze radiali.

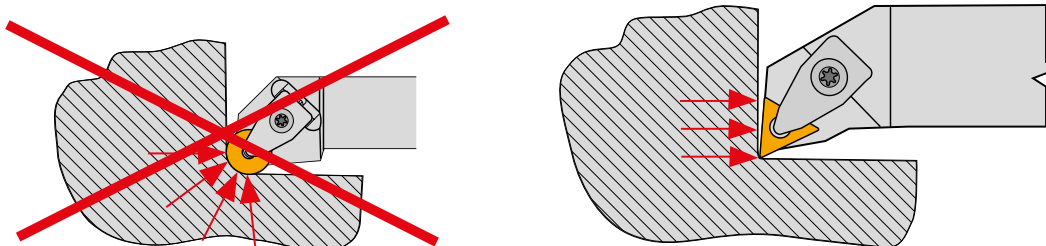

INFLUENZA DEL RAGGIO SULLA DIMENSIONE INSERTO

Influenza del raggio sulla dimensione inserto:

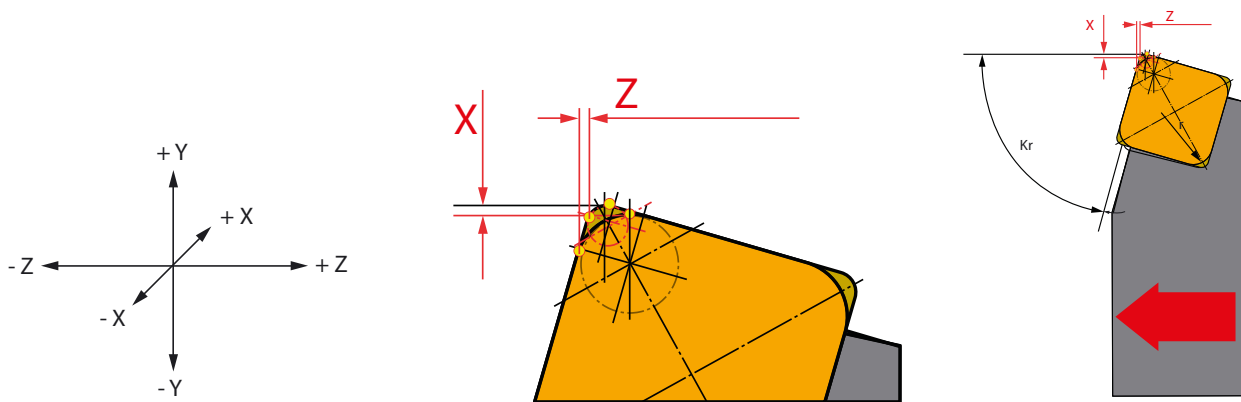

ATTENZIONE – I dati sono validi per utensile versione destra orientato come da fig. Per utensili interni, versione sinistra oppure se diversamente orientati è necessario correggere o marcare +/- (sostituire i valori X/Z)

Utensili		Coordinate	Raggio 0,5	Raggio 1,0	Raggio 1,5				
Utensili esterni	CKJNR/L	x	0.443	0.000	-0.433				
		z	-0.050	0.000	0.050				

Utensili		Coordinate	Raggio 02	Raggio 04	Raggio 08	Raggio 12	Raggio 16	Raggio 24	Raggio 32
Utensili esterni	DCLNR/L	x	0.060	0.040	0.000	-0.040	-0.080	-0.160	-0.240
		z	-0.062	-0.042	0.000	0.042	0.083	0.166	0.249
	DDJNR/L	x	0.516	0.347	0.000	-0.329	-0.667	-1.343	-2.019
		z	-0.056	-0.041	0.000	0.022	0.054	0.117	0.180
	DSBNR/L	x	0.252	0.170	0.000	-0.158	-0.322	-0.649	-0.977
		z	0.422	0.280	0.000	-0.285	-0.568	-1.134	-1.700
	DSDNN	x	0.000	0.000	0.000	0.000	0.000	0.000	0.000
		z	0.247	0.165	0.000	-0.165	-0.33	-0.659	-0.989
	DSKNR/L	x	0.134	0.089	0.000	-0.089	-0.178	-0.358	-0.537
		z	-0.167	-0.111	0.000	0.111	0.222	0.444	0.667
	DSSNR/L	x	0.000	0.000	0.000	0.000	0.000	0.000	0.000
		z	0.245	0.162	0.000	-0.167	-0.322	-0.662	-0.992
	DTFNR/L	x	0.426	0.284	0.000	-0.284	-0.569	-1.137	-1.705
		z	0.029	0.019	0.000	-0.019	-0.04	-0.078	-0.117
	DTGNR/L	x	0.437	0.294	0.000	-0.277	-0.562	-1.133	-1.703
		z	0.000	0.000	0.000	0.000	0.000	0.000	0.000
	DVJNR/L	x	0.063	0.042	0.000	-0.042	-0.084	-0.169	-0.253
		z	1.234	0.823	0.000	-0.823	-1.646	-3.291	-4.937
	DVPNR/L	x	0.79	0.527	0.000	-0.527	-1.054	-2.108	-3.161
		z	0.834	0.554	0.000	-0.554	-1.109	-2.217	-3.326
DWLNR/L	x	0.061	0.044	0.000	-0.026	-0.061	-0.131	-0.200	
	z	-0.063	-0.045	0.000	0.027	0.062	0.134	0.206	

INFLUENZA DEL RAGGIO SULLA DIMENSIONE INSERTO

Utensili		Coordinate	Raggio 02	Raggio 04	Raggio 08	Raggio 12	Raggio 16	Raggio 24	Raggio 32	
Utensili interni	DCLNR/L	x	-0.053	-0.035	0.000	0.035	0.070	0.140	0.210	
		z	-0.060	-0.040	0.000	0.040	0.080	0.159	0.239	
	DDUNR/L	x	-0.512	-0.341	0.000	0.0341	0.683	1.365	2.047	
		z	-0.073	-0.049	0.000	0.049	0.097	0.195	0.292	
	DTFNR/L	x	-0.425	-0.289	0.000	0.254	0.526	1.069	1.613	
		z	0.000	0.000	0.000	0.000	0.000	0.000	0.000	
	DVUNR/L	x	1.254	-0.836	0.000	0.836	1.671	3.343	5.014	
		z	-0.129	-0.086	0.000	0.086	0.172	0.344	0.516	
	DWLNR/L	x	-0.053	-0.035	0.000	0.035	0.07	0.14	0.21	
		z	-0.06	-0.04	0.000	0.04	0.08	0.159	0.239	
	Utensili esterni	MTJNR/L	x	0.437	0.294	0.000	-0.277	-0.562	-1.133	-1.703
			z	0.000	0.000	0.000	0.000	0.000	0.000	0.000
MVJNR/L		x	1.263	0.847	0.000	-0.819	-1.651	-3.317	-4.982	
		z	-0.075	-0.055	0.000	0.025	0.065	0.146	0.226	
MWLNR/L		x	0.609	0.044	0.000	-0.026	-0.061	-0.131	-0.200	
		z	-0.063	-0.045	0.000	0.027	0.062	0.134	0.206	
PCBNR/L		x	0.045	0.033	0.000	-0.016	-0.040	-0.088	-0.137	
		z	0.128	0.083	0.000	-0.096	-0.185	-0.364	-0.543	
PCKNR/L		x	0.171	0.115	0.000	-0.110	-0.223	-0.448	-0.672	
		z	0.685	0.457	0.000	-0.457	-0.914	-1.827	-2.741	
PCLNR/L		x	0.061	0.044	0.000	-0.026	-0.061	-0.131	-0.200	
		z	-0.063	-0.045	0.000	0.027	0.062	0.134	0.206	
PDJNR/L		x	0.516	0.347	0.000	-0.329	-0.667	-1.343	-2.019	
		z	-0.056	-0.041	0.000	0.022	0.054	0.117	0.180	
PDNNR/L		x	0.699	0.469	0.000	-0.453	-0.915	-1.837	-2.759	
		z	0.524	0.348	0.000	-0.357	-0.710	-1.415	-2.120	
PDXNR/L		x	0.453	0.305	0.000	-0.288	-0.584	-1.177	-1.770	
		z	-0.156	-0.107	0.000	0.088	0.185	0.380	0.575	
PLBNR/L		x	0.137	0.094	0.000	-0.078	-0.163	-0.335	-0.507	
		z	0.153	0.100	0.000	-0.110	-0.220	-0.433	-0.646	
PSBNR/L		x	0.137	0.094	0.000	-0.078	-0.163	-0.335	-0.507	
		z	0.153	0.100	0.000	-0.110	-0.220	-0.433	-0.646	
PSDNN		x	0.252	0.170	0.000	-0.158	-0.322	-0.649	-0.977	
		z	0.422	0.280	0.000	-0.285	-0.568	-1.134	-1.699	
PSKNR/L		x	0.140	0.094	0.000	-0.090	-0.152	-0.366	-0.550	
		z	0.574	0.383	0.000	-0.384	-0.767	-1.533	-2.300	
PSSNR/L		x	0.246	0.164	0.000	-0.164	-0.328	-0.656	-0.983	
		z	0.424	0.283	0.000	-0.283	-0.566	-1.131	-1.697	
PTFNR/L		x	0.000	0.000	0.000	0.000	0.000	0.000	0.000	
		z	-0.411	-0.243	0.000	0.429	0.765	1.437	2.110	
PTGNR/L		x	0.437	0.294	0.000	-0.277	-0.562	-1.133	-1.703	
		z	0.000	0.000	0.000	0.000	0.000	0.000	0.000	
PTTNR/L	x	0.601	0.403	0.000	-0.389	-0.784	-1.575	-2.367		
	z	0.519	0.345	0.000	-0.354	-0.703	-1.401	-2.099		
PWLNR/L	x	0.609	0.044	0.000	-0.026	-0.061	-0.131	-0.200		
	z	-0.063	-0.045	0.000	0.027	0.062	0.134	0.206		
Utensili interni	PCLNR/L	x	-0.061	-0.046	0.000	0.012	0.040	0.098	0.156	
		z	-0.062	-0.047	0.000	0.015	0.046	0.160	0.169	
	PDUNR/L	x	-0.500	-0.339	0.000	0.305	0.627	1.271	1.915	
		z	-0.052	-0.040	0.000	0.006	0.029	0.076	0.122	
	PSKNR/L	x	-0.153	-0.097	0.000	0.063	0.143	0.303	0.463	
		z	0.137	0.098	0.000	-0.124	-0.234	-0.456	-0.677	
	PTFNR/L	x	-0.425	-0.289	0.000	0.254	0.526	1.069	1.613	
		z	0.000	0.000	0.000	0.000	0.000	0.000	0.000	
	PWLNR/L	x	-0.060	-0.046	0.000	0.012	0.043	0.098	0.156	
		z	-0.065	-0.049	0.000	0.012	0.040	0.105	0.166	

INFLUENZA DEL RAGGIO SULLA DIMENSIONE INSERTO

Utensili		Coordinate	Raggio 02	Raggio 04	Raggio 08	Raggio 12	Raggio 16	Raggio 24	Raggio 32
Utensili esterni	SCACR/L	x	0.115	0.077	0.000	-0.077	-0.153	-0.307	-0.460
		z	0.000	0.000	0.000	0.000	0.000	0.000	0.000
	SCBCR/L	x	0.042	0.028	0.000	-0.028	-0.055	-0.111	-0.166
		z	0.130	0.087	0.000	-0.087	-0.174	-0.347	-0.521
	SCDCR/L	x	0.000	0.000	0.000	0.000	0.000	0.000	0.000
		z	-0.279	-0.186	0.000	0.186	0.372	0.745	1.117
	SCFCR/L	x	0.000	0.000	0.000	0.000	0.000	0.000	0.000
		z	-0.124	-0.083	0.000	0.083	0.166	0.331	0.497
	SCLCR/L	x	0.060	0.040	0.000	-0.040	-0.080	-0.160	-0.240
		z	-0.062	-0.042	0.000	0.042	0.083	0.166	0.249
	SDJCR/L	x	0.520	0.346	0.000	-0.346	-0.693	-1.386	-2.078
		z	-0.060	-0.040	0.000	0.040	0.080	0.161	0.241
	SDNCN	x	0.699	0.466	0.000	-0.466	-0.933	-1.865	-2.798
		z	0.000	0.000	0.000	0.000	0.000	0.000	0.000
	SEGCR/L	x	0.000	0.000	0.000	0.000	0.000	0.000	0.000
		z	-0.182	-0.121	0.000	0.121	0.243	0.485	0.728
	SSBCR/L	x	0.135	0.090	0.000	-0.090	-0.180	-0.360	-0.539
		z	0.155	0.104	0.000	-0.104	-0.207	-0.414	-0.621
	SSDCN	x	0.249	0.166	0.000	-0.166	-0.331	-0.663	-0.994
		z	0.000	0.000	0.000	0.000	0.000	0.000	0.000
	SSKCR/L	x	-0.376	-0.517	0.000	-1.083	-1.366	-1.931	-2.497
		z	-0.135	-0.090	0.000	0.090	0.180	0.360	0.539
	STCFR/L	x	0.000	0.000	0.000	0.000	0.000	0.000	0.000
		z	-	-	0.000	-	-	-	-
	STJCR/L	x	0.406	0.271	0.000	-0.271	-0.542	-1.084	-1.626
		z	-0.054	-0.036	0.000	0.036	0.071	0.143	-0.214
	SVACR/L	x	00 / 0	01 / -0.107	-	-	-	-	-
		z	00 / 0	01 / -0.107	-	-	-	-	-
	SVGCR/L	x	0.000	0.000	0.000	0.000	0.000	0.000	0.000
		z	-1.303	-0.869	0.000	0.869	1.737	3.475	5.212
	SVHBR/L	x	1.034	0.690	0.000	-0.690	-1.379	-2.759	-4.138
		z	-0.544	-0.363	0.000	0.363	0.726	1.452	2.178
	SVHCR/L	x	1.034	0.690	0.000	-0.690	-1.379	-2.759	-4.138
		z	-0.544	-0.363	0.000	0.363	0.726	1.452	2.178
	SVJBR/L	x	1.269	0.846	0.000	-0.846	-1.692	-3.384	-5.076
		z	-0.099	-0.066	0.000	0.066	0.132	0.263	0.395
	SVJCR/L	x	1.269	0.846	0.000	-0.846	-1.692	-3.384	-5.076
		z	-0.099	-0.066	0.000	0.066	0.132	0.263	0.395
	SVPBR/L	x	0.811	0.541	0.000	-0.541	-1.081	-2.162	-3.244
		z	-0.811	-0.541	0.000	0.541	1.081	2.162	3.244
	SVPBR/L	x	0.811	0.541	0.000	-0.541	-1.081	-2.162	-3.244
		z	-0.811	-0.541	0.000	0.541	1.081	2.162	3.244
	SVVBN	x	1.395	0.930	0.000	-0.930	-1.860	-3.721	-5.581
		z	0.000	0.000	0.000	0.000	0.000	0.000	0.000
	SVVCN	x	1.395	0.930	0.000	-0.930	-1.860	-3.721	-5.581
		z	0.000	0.000	0.000	0.000	0.000	0.000	0.000
	SVXBR/L	x	1.201	0.801	0.000	-0.801	-1.601	-3.202	-4.804
		z	-0.259	-0.173	0.000	0.173	0.345	0.691	1.036
SVXCR/L	x	1.201	0.801	0.000	-0.801	-1.601	-3.202	-4.804	
	z	-0.259	-0.173	0.000	0.173	0.345	0.691	1.036	
SWLCR/L	x	0.060	0.040	0.000	-0.040	-0.080	-0.160	-0.240	
	z	-0.060	-0.040	0.000	0.040	0.080	0.160	0.240	

INFLUENZA DEL RAGGIO SULLA DIMENSIONE INSERTO

Utensili		Coordinate	Raggio 02	Raggio 04	Raggio 08	Raggio 12	Raggio 16	Raggio 24	Raggio 32
Utensili interni	SCFCR/L	x	-0.420	-0.280	0.000	0.280	0.560	1.121	1.681
		z	0.000	0.000	0.000	0.000	0.000	0.000	0.000
	SCKCR/L	x	-0.040	-0.027	0.000	0.027	0.054	0.108	0.161
		z	0.130	0.087	0.000	-0.087	-0.174	-0.348	0.521
	SCLCR/L	x	-0.058	-0.039	0.000	0.039	0.078	0.155	0.233
		z	-0.062	-0.042	0.000	0.042	0.083	0.166	0.249
	SCXCR/L	x	-0.178	-0.119	0.000	0.119	0.237	0.474	0.711
		z	0.000	0.000	0.000	0.000	0.000	0.000	0.000
	SDQCR/L	x	-0.309	-0.194	0.000	0.206	0.412	0.825	1.237
		z	-0.310	-0.206	0.000	0.268	0.499	0.961	1.423
	SDUCR/L	x	-0.504	-0.336	0.000	0.336	0.672	1.344	2.016
		z	-0.059	-0.039	0.000	0.041	0.082	0.162	0.242
	SDZCR/L	x	-0.520	-0.346	0.000	0.346	0.693	0.139	2.078
		z	0.059	0.039	0.000	-0.041	-0.082	-0.162	-0.242
	SELPR/L	x	-0.126	-0.084	0.000	0.084	0.168	0.337	0.051
		z	-0.066	-0.044	0.000	0.044	0.088	0.176	0.264
	SEUCR/L	x	-0.149	-0.099	0.000	0.099	0.199	0.397	0.596
		z	-0.041	-0.027	0.000	0.027	0.053	0.107	0.160
	SEUPR/L	x	-0.148	-0.099	0.000	0.099	0.198	0.396	0.593
		z	-0.040	-0.027	0.000	0.027	0.053	0.107	0.160
	SEXPR/L	x	-0.384	-0.256	0.000	0.256	0.512	1.024	1.537
		z	0.000	0.000	0.000	0.000	0.000	0.000	0.000
	SSSCR/L	x	-0.249	-0.166	0.000	0.166	0.331	0.663	0.994
		z	0.000	0.000	0.000	0.000	0.000	0.000	0.000
	STFCR/L	x	-0.433	-0.289	0.000	0.289	0.577	1.154	1.731
		z	0.000	0.000	0.000	0.000	0.000	0.000	0.000
	SVLCR/L	x	-1.243	-0.828	0.000	0.828	1.657	3.314	4.971
		z	0.239	0.692	0.000	-0.108	-0.215	-0.430	-0.645
	SVQBR/L	x	-1.027	-0.684	0.000	0.690	1.369	2.738	4.106
		z	-0.545	-0.363	0.000	0.363	0.726	1.452	2.178
	SVQCR/L	x	-1.027	-0.684	0.000	0.690	1.369	2.738	4.106
		z	-0.545	-0.363	0.000	0.363	0.726	1.452	2.178
	SVUBR/L	x	-1.259	-0.840	0.000	0.840	1.679	3.358	5.037
		z	0.099	-0.066	0.000	0.066	0.132	0.263	0.395
	SVUCR/L	x	-1.259	-0.840	0.000	0.840	1.679	3.358	5.037
		z	0.099	-0.066	0.000	0.066	0.132	0.263	0.395
	SVXCR/L	x	-0.917	-0.611	0.000	0.611	1.222	2.445	3.667
		z	-0.696	-0.464	0.000	0.464	0.928	1.856	2.783
	SWLCR/L	x	-0.060	-0.039	0.000	0.039	0.079	0.158	0.237
		z	-0.060	-0.040	0.000	0.040	0.080	0.160	0.240
SWUCR/L	x	-0.080	-0.053	0.000	0.053	0.107	0.213	0.319	
	z	-0.034	-0.024	0.000	0.024	0.049	0.098	0.146	

ATTENZIONE – I dati sono validi per utensile versione destra orientato come da fig. Per utensili interni, versione sinistra oppure se diversamente orientati è necessario correggere o marcare +/- (sostituire i valori X/Z)

FILETTATURA

Secondo la forma del pezzo ed il tipo di macchina si sceglie il metodo di base di tornitura, cioè la direzione dell'avanzamento ed il senso di rotazione per la tornitura della filettatura destra o sinistra interna ed esterna. La scelta si può effettuare secondo l'illustrazione della tabella.

FILETTATURA ESTERNA DESTRA

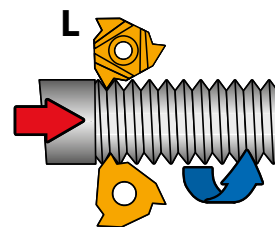
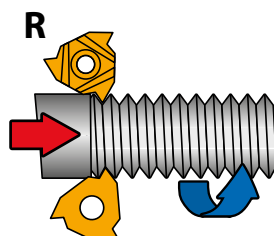
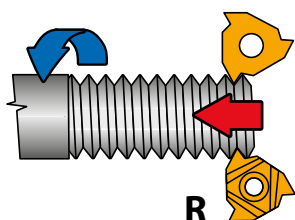

FILETTATURA ESTERNA SINISTRA

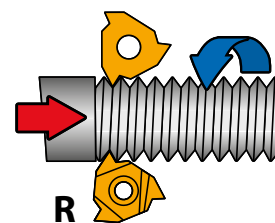
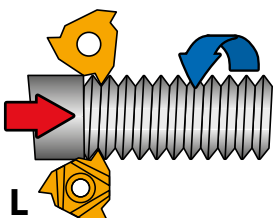
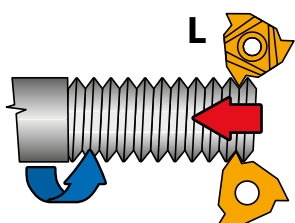

FILETTATURA INTERNA DESTRA

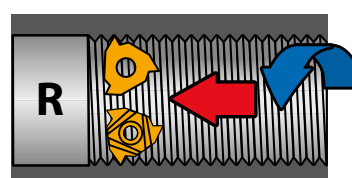
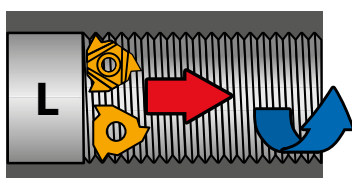

FILETTATURA INTERNA SINISTRA

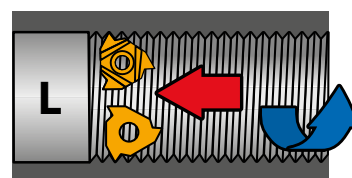
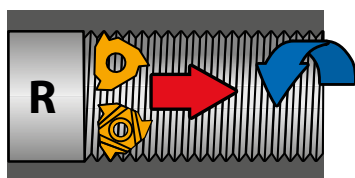

■ Movimento del pezzo

■ Movimento dell'utensile

L/R Tipo di inserto

L'angolo dell'elica si può calcolare secondo la formula:

$$\operatorname{tg} \omega = \frac{p}{d_s \cdot \pi}$$

- ω Angolo dell'elica [°]
- p Passo della filettatura [mm]
- d_s Diametro medio della filettatura [mm]

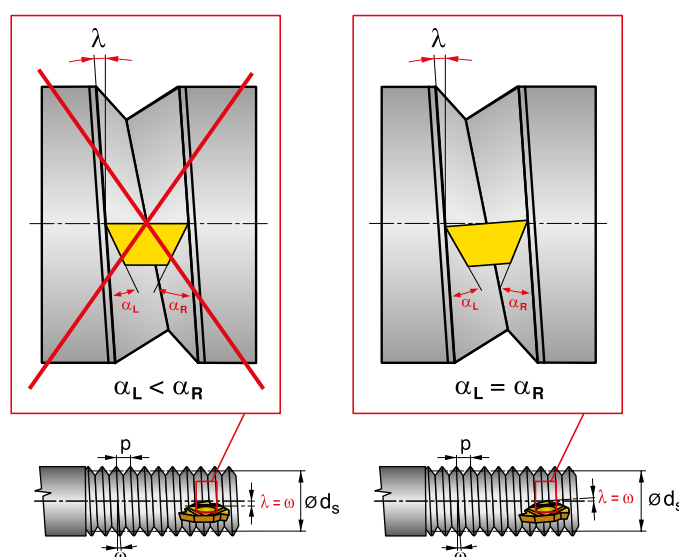

L'angolo d'inclinazione dell'inserto sull'utensile deve corrispondere all'angolo dell'elica della filettatura perché, nel caso in cui i due angoli differiscano notevolmente, si verifica uno strisciamento sul fianco dell'inserto sul filetto. L'impostazione delle sedi inserti negli utensili per filettatura prevede un angolo d'inclinazione costante (inclinazione dell'inserto) $\lambda = 1.5^\circ$. Per raggiungere l'inclinazione desiderata „ λ “ simile all'angolo dell'elica della filettatura „ ω “, è necessario inserire una sottopiacchetta che modifica il valore dell'angolo in modo da raggiungere l'angolo d'inclinazione dell'inserto richiesto grafico. Per scegliere una sottopiacchetta adatta da inserire per eseguire una determinata filettatura con diametro e passo viene predisposta la seguente tabella o il grafico.

Selezione sottopiacchetta

Angolo dell'elica λ	Positivo					Negativo		Per inserti a scanalatura TN16... ZZ, TN22... ZZ
	4.5°	3.5°	2.5°	1.5°	0.5°	-0.5°	-1.5°	
Utensile per filettatura	Sottopiacchetta							
SER16; SIL16	PE16+4.5	PE16+3.5	PE16+2.5	PE16+1.5	PE16+0.5	PE16-0.5	PE16-1.5	PE16ZZ
SEL16; SIR16	PI16+4.5	PI16+3.5	PI16+2.5	PI16+1.5	PI16+0.5	PI16-0.5	PI16-1.5	PI16ZZ
SER22; SIL22	PE22+4.5	PE22+3.5	PE22+2.5	PE22+1.5	PE22+0.5	PE22-0.5	PE22-1.5	PE22ZZ
SEL22; SIR22	PI22+4.5	PI22+3.5	PI22+2.5	PI22+1.5	PI22+0.5	PI22-0.5	PI22-1.5	PI22ZZ
SER-S22; SIL-S22	PE22S+4.5	PE22S+3.5	PE22S+2.5	PE22S+1.5	PE22S+0.5	PE22S-0.5	PE22S-1.5	-
SEL-S22; SIR-S22	PI22S+4.5	PI22S+3.5	PI22S+2.5	PI22S+1.5	PI22S+0.5	PI22S-0.5	PI22S-1.5	-

Nota di solito gli utensili per filettare hanno un angolo d'inclinazione predisposto $\lambda = 1.5^\circ$. L'angolo d'inclinazione può essere modificato mediante sottopiacchetta intercambiabile. Vedi tabella e diagramma. Sottopiacchetta per utensile SER-S sono marcati con „S“

Grafico per la scelta della sottopiacchetta

Passo P [mm]

N. di filetti / 1"

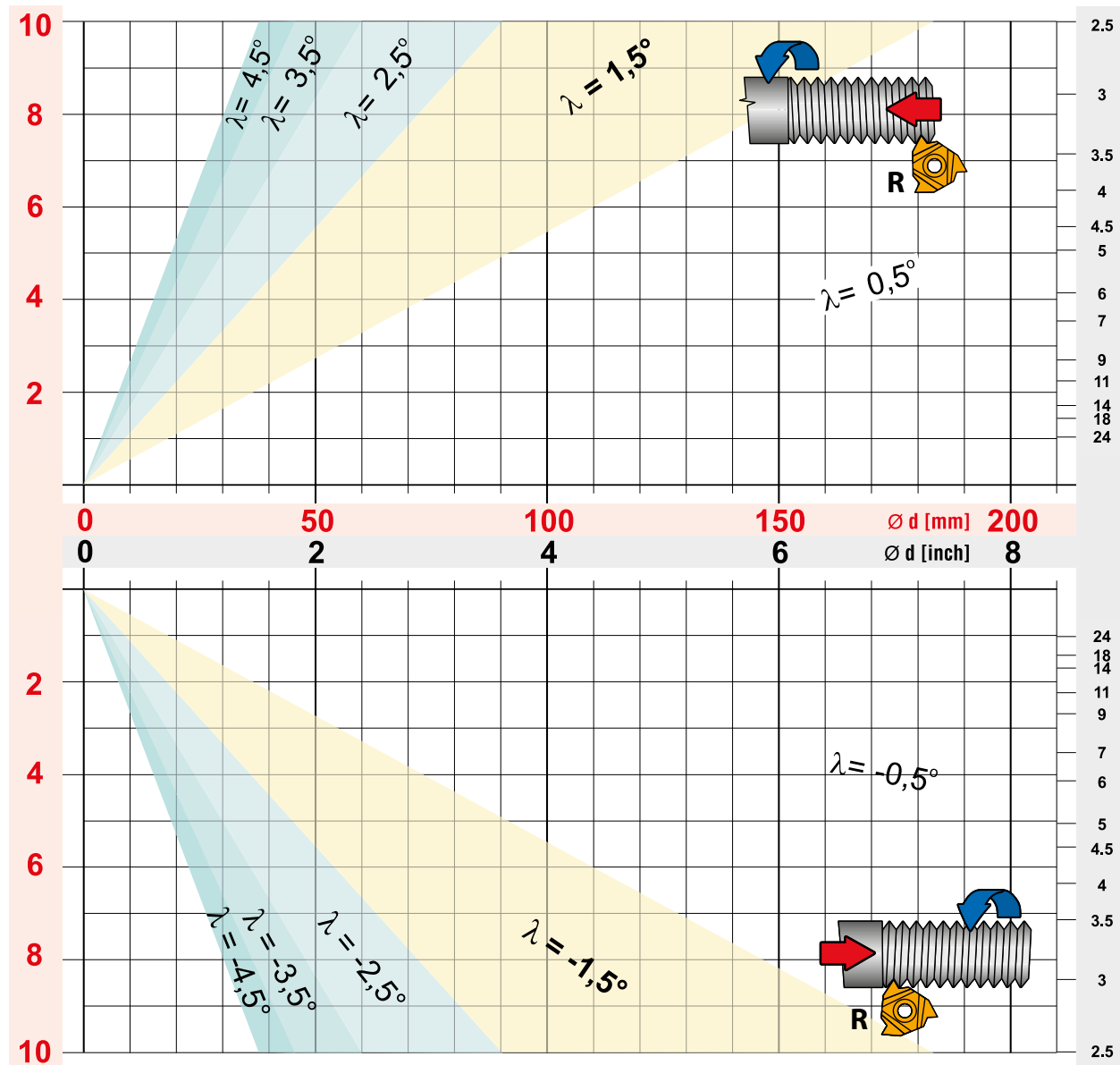

■ Movimento del pezzo

■ Movimento dell'utensile

L / R Tipo di inserto

Metodo di avanzamento e di incremento passate

Per formare l'intero profilo della filettatura esistono tre metodi diversi di incremento: radiale, laterale ed alternato.

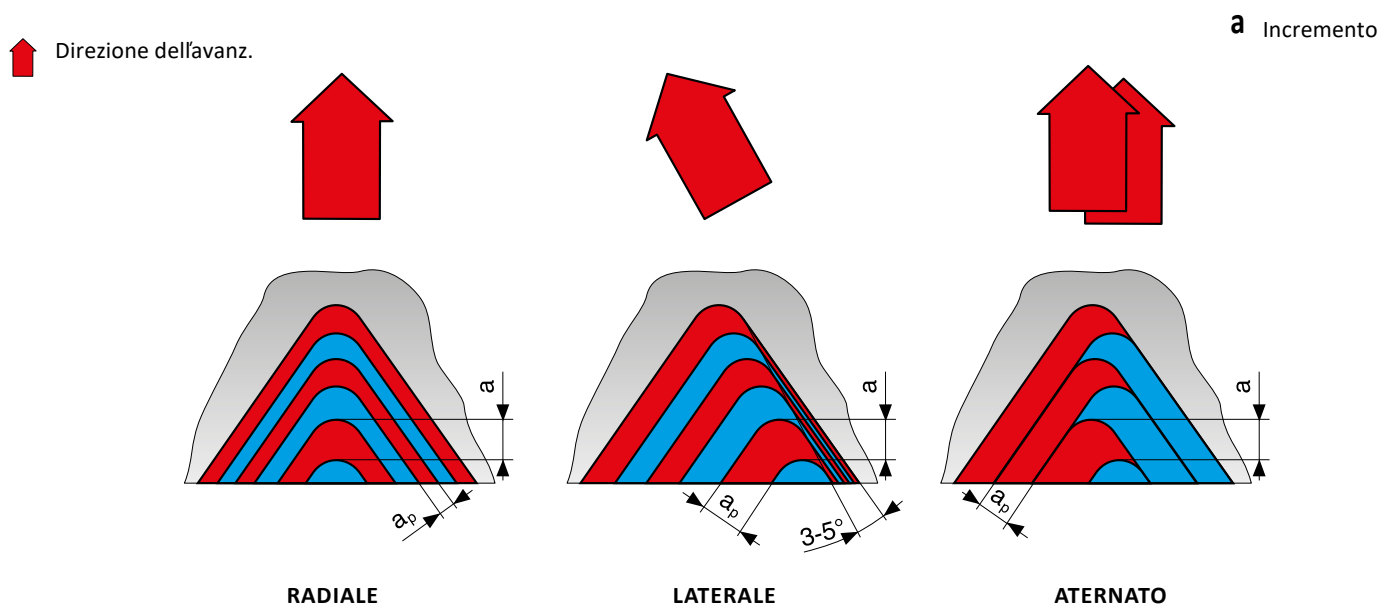

La scelta del metodo di incremento adatto dipende dal tipo di tornio, dal tipo di materiale lavorato e dal passo della filettatura.

Incremento radiale – è il più semplice ed il più usato. L'incremento è perpendicolare all'asse di rotazione del pezzo – l'asportazione del materiale ha luogo su entrambi i profili laterali. Contribuisce alla creazione favorevole di truciolo e quindi all'usura proporzionale del tagliente. È adatto per filettature con passi di basso valore ($p < 1,5$ mm). Per passi maggiori l'incremento radiale può dare luogo all'insorgere di vibrazioni. L'incremento radiale è adatto per materiali a un truciolo corto, per acciai inossidabili austenitici e acciai con basso contenuto di carbonio.

Incremento laterale – diminuisce il carico termico della punta del tagliente dell'inserto e quindi diminuisce l'usura. Permette anche una migliore forma e uscita del truciolo. Si usa per scanalature con passo $p > 1,5$ mm e per l'esecuzione di filettature trapezoidali. Incrementi sul fianco con angolo di $3^\circ - 5^\circ$ eliminano l'attrito sul fianco della filettatura.

Incremento alternato – è adatto per grandi passi e materiali che formano un truciolo lungo difficilmente trattabile. Il vantaggio è la suddivisione più proporzionata dell'asportazione di materiale su entrambi i lati e quindi un'usura più uniforme del tagliente dell'inserto. È più complicata la programmazione della macchina.

Valore di incremento e numero di passate – dipendono essenzialmente dal passo della filettatura. Per diversi tipi di filettatura si possono scegliere secondo le tabelle. I valori indicati vanno considerati orientativi di partenza e si possono correggere secondo la situazione concreta. Nel caso in cui si arrivi a usura prematura del tagliente, si raccomanda di diminuire il valore di incremento ed aumentare di conseguenza il numero di passate. Il valore di incremento non dovrebbe essere mai inferiore a 0,05 mm o, per la tornitura di acciai austenitici e morbidi, l'incremento ammissibile minimo è 0,08 mm.

PROFONDITÀ DI PASSATA

PROFILO FILETTATO CILINDRICO CORRISPONDENTE CON W (WHITWORTH 55°)					
Codice filettatura	N. di filetti / 1"	Passo P [mm]	Diametro nominale filetto [mm]	Diametro minore filetto [mm]	Marcatura sull'inserto
G 1/16"	28	0,907	7.723	6.561	TN xxxx280W
G 1/8"			9.728	8.566	
G 1/4"	19	1,337	13.157	11.445	TN xxxx190W
G 3/8"			16.662	14.950	
G 1/2"	14	1,814	20.955	18.631	TN xxxx140W
G 5/8"			22.911	20.587	
G 3/4"			26.441	24.117	
G 7/8"			30.201	27.877	
G 1"	11	2,309	33.249	30.291	TN xxxx110W
G1 1/8"			37.897	34.939	
G1 1/4"			41.910	38.952	
G1 1/2"			47.803	44.845	
G1 3/4"			53.746	50.788	
G 2"			59.614	56.656	
G2 1/4"			65.710	62.752	
G2 1/2"			75.184	72.226	
G2 3/4"			81.534	78.576	
G3"			87.884	84.926	
G3 1/2"			100.330	97.372	
G4"			113.030	110.072	
G4 1/2"			125.730	122.772	
G5"			138.430	135.472	
G5 1/2"			151.130	148.172	
G6"			163.830	160.872	

Esempio: per filettatura esterna su tubo 1 1/2" usare inserto TN 16ER110W; 8030

PROFONDITÀ DI PASSATA

M – metrico 60° – esterna

Numero di passate	DIMINUIRE LA VELOCITÀ DI TAGLIO PROPORZIONALMENTE ALL'INCREMENTO DELLA PROFONDITÀ														
	Profondità del profilo [mm]														
	6.0	5.5	5.0	4.5	4.0	3.5	3.0	2.5	2.0	1.75	1.5	1.25	1.0	0.75	0.50
1	0.46	0.43	0.41	0.37	0.34	0.34	0.28	0.27	0.24	0.22	0.22	0.21	0.18	0.16	0.11
2	0.43	0.40	0.39	0.34	0.32	0.31	0.26	0.24	0.22	0.20	0.20	0.17	0.16	0.14	0.09
3	0.35	0.32	0.32	0.28	0.25	0.25	0.21	0.20	0.18	0.17	0.17	0.14	0.12	0.11	0.07
4	0.30	0.28	0.27	0.24	0.22	0.21	0.18	0.17	0.16	0.14	0.14	0.11	0.11	0.07	0.06
5	0.29	0.26	0.24	0.22	0.20	0.18	0.16	0.15	0.14	0.12	0.12	0.10	0.08		
6	0.26	0.24	0.24	0.22	0.18	0.18	0.15	0.15	0.12	0.10	0.08	0.08			
7	0.24	0.21	0.22	0.20	0.17	0.16	0.14	0.12	0.11	0.10					
8	0.23	0.20	0.20	0.18	0.15	0.15	0.13	0.11	0.08	0.08					
9	0.22	0.19	0.19	0.17	0.14	0.14	0.12	0.11							
10	0.19	0.18	0.18	0.16	0.13	0.12	0.11	0.08							
11	0.18	0.17	0.16	0.14	0.12	0.11	0.10								
12	0.16	0.15	0.15	0.13	0.12	0.08	0.08								
13	0.15	0.14	0.12	0.12	0.11										
14	0.13	0.13	0.10	0.10	0.08										
15	0.13	0.12													
16	0.10	0.10													
Profondità del profilo	3.83	3.52	3.19	2.87	2.53	2.23	1.92	1.60	1.25	1.13	0.93	0.81	0.65	0.48	0.33

M – metrico 60° – interna

Numero di passate	DIMINUIRE LA VELOCITÀ DI TAGLIO PROPORZIONALMENTE ALL'INCREMENTO DELLA PROFONDITÀ														
	Profondità del profilo [mm]														
	6.0	5.5	5.0	4.5	4.0	3.5	3.0	2.5	2.0	1.75	1.5	1.25	1.0	0.75	0.50
1	0.46	0.43	0.42	0.37	0.34	0.32	0.28	0.26	0.23	0.22	0.20	0.17	0.17	0.16	0.10
2	0.43	0.40	0.40	0.34	0.31	0.30	0.26	0.25	0.21	0.20	0.18	0.17	0.15	0.13	0.08
3	0.35	0.33	0.32	0.28	0.24	0.24	0.21	0.18	0.17	0.15	0.15	0.14	0.11	0.10	0.07
4	0.30	0.26	0.26	0.23	0.21	0.19	0.16	0.15	0.15	0.13	0.13	0.10	0.09	0.07	0.06
5	0.26	0.22	0.22	0.21	0.18	0.17	0.14	0.13	0.12	0.10	0.11	0.09	0.08		
6	0.22	0.20	0.20	0.19	0.15	0.15	0.13	0.12	0.11	0.09	0.08	0.08			
7	0.20	0.18	0.17	0.16	0.14	0.14	0.12	0.11	0.10	0.08					
8	0.19	0.17	0.16	0.15	0.13	0.13	0.11	0.10	0.08	0.08					
9	0.18	0.16	0.16	0.14	0.12	0.12	0.10	0.10							
10	0.16	0.15	0.15	0.13	0.12	0.11	0.10	0.08							
11	0.15	0.14	0.14	0.12	0.11	0.10	0.09								
12	0.15	0.14	0.14	0.12	0.10	0.08	0.08								
13	0.14	0.13	0.12	0.11	0.10										
14	0.13	0.12	0.10	0.10	0.08										
15	0.12	0.12													
16	0.10	0.10													
Profondità del profilo	3.54	3.25	2.96	2.65	2.33	2.05	1.78	1.48	1.17	1.05	0.85	0.75	0.60	0.46	0.31

PROFONDITÀ DI PASSATA

W – Whitworth 55° – esterna e interna

Numero di passate	DIMINUIRE LA VELOCITÀ DI TAGLIO PROPORZIONALMENTE ALL'INCREMENTO DELLA PROFONDITA'																
	Profondità del profilo [numero di scanalature/pollice]																
	4	4.5	5	6	7	8	9	10	11	12	14	16	18	19	20	26	28
1	0.49	0.46	0.45	0.38	0.37	0.32	0.30	0.29	0.28	0.28	0.24	0.24	0.23	0.22	0.21	0.19	0.18
2	0.46	0.43	0.43	0.36	0.35	0.30	0.28	0.27	0.26	0.26	0.22	0.22	0.22	0.22	0.21	0.18	0.17
3	0.38	0.38	0.38	0.30	0.29	0.24	0.23	0.22	0.22	0.22	0.18	0.19	0.19	0.18	0.17	0.15	0.14
4	0.36	0.33	0.32	0.26	0.25	0.21	0.20	0.19	0.19	0.18	0.15	0.16	0.16	0.14	0.14	0.12	0.12
5	0.34	0.29	0.28	0.22	0.22	0.19	0.18	0.17	0.16	0.16	0.13	0.13	0.13	0.12	0.11	0.08	0.08
6	0.31	0.25	0.25	0.21	0.19	0.17	0.15	0.15	0.14	0.14	0.11	0.11	0.08	0.08	0.08		
7	0.29	0.24	0.22	0.19	0.18	0.15	0.14	0.14	0.13	0.13	0.09	0.08					
8	0.27	0.22	0.20	0.17	0.16	0.14	0.13	0.13	0.12	0.08	0.08						
9	0.24	0.20	0.19	0.16	0.15	0.13	0.12	0.12	0.08								
10	0.22	0.18	0.18	0.15	0.14	0.12	0.12	0.08									
11	0.20	0.17	0.17	0.14	0.12	0.12	0.08										
12	0.19	0.16	0.15	0.14	0.08	0.08											
13	0.17	0.15	0.12	0.12													
14	0.15	0.14	0.10	0.10													
15	0.12	0.12															
16	0.10	0.10															
Profondità del profilo	4.29	3.82	3.44	2.90	2.50	2.17	1.93	1.76	1.58	1.45	1.20	1.13	1.01	0.96	0.92	0.72	0.69

UN 60° – esterna

Numero di passate	DIMINUIRE LA VELOCITÀ DI TAGLIO PROPORZIONALMENTE ALL'INCREMENTO DELLA PROFONDITA'																	
	Profondità del profilo [numero di scanalature/pollice]																	
	4	4.5	5	6	7	8	9	10	11	12	13	14	16	18	20	24	28	32
1	0.47	0.45	0.43	0.36	0.35	0.30	0.28	0.27	0.27	0.27	0.25	0.23	0.22	0.23	0.20	0.19	0.17	0.17
2	0.44	0.41	0.40	0.34	0.33	0.28	0.26	0.26	0.25	0.26	0.24	0.22	0.21	0.21	0.19	0.17	0.15	0.15
3	0.40	0.39	0.36	0.27	0.26	0.25	0.21	0.20	0.20	0.20	0.18	0.17	0.16	0.16	0.15	0.14	0.11	0.13
4	0.36	0.31	0.31	0.23	0.22	0.21	0.20	0.17	0.19	0.18	0.17	0.15	0.14	0.14	0.12	0.12	0.09	0.08
5	0.32	0.26	0.26	0.22	0.21	0.18	0.17	0.16	0.16	0.15	0.14	0.13	0.13	0.12	0.10	0.08	0.08	
6	0.27	0.23	0.23	0.20	0.19	0.16	0.15	0.15	0.14	0.13	0.12	0.11	0.11	0.08	0.08			
7	0.25	0.21	0.20	0.18	0.17	0.14	0.14	0.14	0.12	0.12	0.11	0.10	0.08					
8	0.23	0.20	0.19	0.16	0.15	0.13	0.12	0.12	0.11	0.08	0.08	0.08						
9	0.22	0.18	0.19	0.15	0.14	0.12	0.12	0.11	0.08									
10	0.21	0.17	0.18	0.14	0.12	0.12	0.11	0.08										
11	0.19	0.16	0.17	0.13	0.11	0.11	0.08											
12	0.18	0.15	0.15	0.12	0.08	0.08												
13	0.16	0.14	0.12	0.11														
14	0.15	0.14	0.10	0.10														
15	0.12	0.12																
16	0.10	0.10																
Profondità del profilo	4.07	3.62	3.29	2.71	2.33	2.08	1.84	1.66	1.52	1.39	1.29	1.19	1.05	0.94	0.84	0.70	0.60	0.53

PROFONDITÀ DI PASSATA

UN 60° – interna

Numero di passate	DIMINUIRE LA VELOCITÀ DI TAGLIO PROPORZIONALMENTE ALL'INCREMENTO DELLA PROFONDITA'																	
	Profondità del profilo [numero di scanalature/pollice]																	
	4	4.5	5	6	7	8	9	10	11	12	13	14	16	18	20	24	28	32
1	0.44	0.41	0.42	0.35	0.34	0.30	0.28	0.27	0.27	0.27	0.25	0.23	0.22	0.23	0.20	0.18	0.17	0.17
2	0.41	0.38	0.38	0.33	0.32	0.28	0.26	0.25	0.23	0.23	0.20	0.18	0.18	0.17	0.16	0.15	0.14	0.14
3	0.39	0.34	0.33	0.25	0.24	0.22	0.19	0.18	0.18	0.18	0.15	0.14	0.14	0.14	0.13	0.13	0.09	0.10
4	0.33	0.28	0.27	0.21	0.21	0.18	0.16	0.15	0.15	0.15	0.13	0.13	0.12	0.12	0.10	0.10	0.08	0.08
5	0.28	0.23	0.23	0.18	0.17	0.15	0.14	0.13	0.13	0.13	0.12	0.11	0.10	0.10	0.09	0.08	0.08	
6	0.24	0.20	0.20	0.16	0.15	0.13	0.13	0.12	0.11	0.11	0.11	0.10	0.09	0.08	0.08			
7	0.22	0.19	0.18	0.15	0.14	0.12	0.12	0.11	0.11	0.10	0.10	0.09	0.08					
8	0.21	0.18	0.17	0.14	0.13	0.11	0.11	0.10	0.10	0.08	0.08	0.08						
9	0.20	0.17	0.16	0.13	0.12	0.11	0.10	0.10	0.08									
10	0.18	0.16	0.15	0.12	0.12	0.10	0.09	0.08										
11	0.17	0.15	0.14	0.12	0.11	0.10	0.08											
12	0.16	0.14	0.14	0.11	0.08	0.08												
13	0.15	0.14	0.12	0.11														
14	0.14	0.13	0.10	0.10														
15	0.12	0.12																
16	0.10	0.10																
Profondità del profilo	3.74	3.32	2.99	2.46	2.13	1.88	1.66	1.49	1.36	1.25	1.14	1.06	0.93	0.84	0.76	0.64	0.56	0.49

NPT 60° – interna ed esterna

Numero di passate	DIMINUIRE LA VELOCITÀ DI TAGLIO PROPORZIONALMENTE ALL'INCREMENTO DELLA PROFONDITA'				
	Profondità del profilo [numero di scanalature/pollice]				
	8	11.5	14	18	27
1	0.28	0.25	0.24	0.22	0.19
2	0.25	0.22	0.22	0.18	0.15
3	0.22	0.18	0.17	0.15	0.13
4	0.19	0.16	0.15	0.14	0.11
5	0.18	0.16	0.14	0.13	0.09
6	0.18	0.14	0.13	0.12	0.08
7	0.17	0.14	0.12	0.10	
8	0.17	0.12	0.10	0.08	
9	0.16	0.12	0.10		
10	0.16	0.10	0.08		
11	0.14	0.09			
12	0.13	0.08			
13	0.12				
14	0.11				
15	0.08				
Profondità del profilo	2.54	1.76	1.45	1.12	0.75

PROFONDITÀ DI PASSATA

DIN 405 tonda – esterna

Numero di passate	DIMINUIRE LA VELOCITÀ DI TAGLIO PROPORZIONALMENTE ALL'INCREMENTO DELLA PROFONDITÀ'			
	Profondità del profilo [numero di scanalature/pollice]			
	4	6	8	10
1	0.44	0.33	0.29	0.26
2	0.40	0.29	0.26	0.25
3	0.34	0.25	0.21	0.23
4	0.32	0.23	0.19	0.20
5	0.28	0.20	0.18	0.16
6	0.26	0.18	0.16	0.12
7	0.24	0.16	0.14	0.10
8	0.22	0.15	0.12	0.08
9	0.20	0.14	0.10	
10	0.19	0.12	0.08	
11	0.17	0.10		
12	0.15	0.08		
13	0.12			
14	0.10			
Profondità del profilo	3.43	2.23	1.73	1.40

DIN 405 tonda – interna

Numero di passate	DIMINUIRE LA VELOCITÀ DI TAGLIO PROPORZIONALMENTE ALL'INCREMENTO DELLA PROFONDITÀ'			
	Profondità del profilo [numero di scanalature/pollice]			
	4	6	8	10
1	0.46	0.38	0.26	0.27
2	0.43	0.34	0.22	0.26
3	0.40	0.30	0.21	0.25
4	0.35	0.25	0.19	0.22
5	0.30	0.21	0.18	0.18
6	0.26	0.19	0.16	0.13
7	0.24	0.17	0.14	0.10
8	0.22	0.16	0.12	0.08
9	0.20	0.14	0.10	
10	0.19	0.12	0.08	
11	0.17	0.10		
12	0.15	0.08		
13	0.12			
14	0.10			
Profondità del profilo	3.59	2.44	1.66	1.49

PROFONDITÀ DI PASSATA

Trapezio 30° – esterna

Numero di passate	DIMINUIRE LA VELOCITÀ DI TAGLIO PROPORZIONALMENTE ALL'INCREMENTO DELLA PROFONDITÀ											
	Profondità del profilo [mm]											
	14,0	12,0	10,0	9,0	8,0	7,0	6,0	5,0	4,0	3,0	2,0	1,5
1	0.40	0.38	0.38	0.38	0.37	0.37	0.37	0.34	0.31	0.27	0.25	0.23
2	0.37	0.36	0.36	0.35	0.35	0.34	0.35	0.33	0.28	0.25	0.24	0.22
3	0.36	0.34	0.34	0.34	0.34	0.33	0.32	0.27	0.24	0.21	0.20	0.18
4	0.36	0.34	0.34	0.33	0.33	0.31	0.29	0.25	0.20	0.17	0.17	0.14
5	0.35	0.32	0.32	0.31	0.31	0.29	0.27	0.23	0.19	0.15	0.14	0.12
6	0.35	0.32	0.32	0.30	0.29	0.26	0.25	0.21	0.18	0.13	0.13	0.08
7	0.34	0.30	0.31	0.29	0.28	0.26	0.23	0.20	0.16	0.13	0.11	
8	0.34	0.30	0.29	0.28	0.27	0.26	0.22	0.20	0.15	0.12	0.09	
9	0.34	0.30	0.28	0.26	0.25	0.24	0.22	0.18	0.15	0.12		
10	0.33	0.29	0.27	0.25	0.24	0.23	0.20	0.16	0.15	0.10		
11	0.33	0.29	0.25	0.24	0.23	0.22	0.18	0.15	0.14	0.10		
12	0.32	0.29	0.24	0.23	0.21	0.22	0.17	0.14	0.13	0.08		
13	0.32	0.28	0.23	0.22	0.20	0.20	0.17	0.13	0.10			
14	0.31	0.27	0.22	0.21	0.19	0.19	0.16	0.10				
15	0.31	0.25	0.22	0.21	0.19	0.17	0.14					
16	0.30	0.25	0.20	0.19	0.18	0.16	0.12					
17	0.30	0.24	0.19	0.18	0.17	0.12						
18	0.29	0.22	0.18	0.16	0.15							
19	0.28	0.20	0.17	0.15	0.13							
20	0.27	0.20	0.16	0.15								
21	0.23	0.19	0.15	0.13								
22	0.23	0.18	0.15									
23	0.21	0.17	0.13									
24	0.19	0.16										
25	0.17	0.15										
26	0.16	0.13										
27	0.16											
28	0.15											
29	0.13											
Profondità del profilo	8.2	6.72	5.7	5.16	4.68	4.17	3.66	2.89	2.38	1.83	1.33	0.97

PROFONDITÀ DI PASSATA

Trapezio 30° – interna

Numero di passate	DIMINUIRE LA VELOCITÀ DI TAGLIO PROPORZIONALMENTE ALL'INCREMENTO DELLA PROFONDITA'											
	Profondità del profilo [mm]											
	14,0	12,0	10,0	9,0	8,0	7,0	6,0	5,0	4,0	3,0	2,0	1,5
1	0.40	0.38	0.38	0.38	0.37	0.37	0.37	0.34	0.31	0.27	0.25	0.23
2	0.37	0.36	0.36	0.35	0.35	0.34	0.34	0.33	0.28	0.25	0.24	0.22
3	0.36	0.34	0.34	0.34	0.34	0.33	0.32	0.27	0.24	0.22	0.21	0.19
4	0.36	0.34	0.34	0.33	0.33	0.31	0.29	0.25	0.20	0.17	0.17	0.14
5	0.35	0.32	0.32	0.31	0.31	0.29	0.27	0.23	0.19	0.15	0.14	0.12
6	0.35	0.32	0.32	0.31	0.29	0.26	0.25	0.21	0.18	0.14	0.13	0.08
7	0.34	0.30	0.31	0.29	0.28	0.26	0.23	0.20	0.16	0.13	0.11	
8	0.34	0.30	0.29	0.29	0.27	0.26	0.22	0.20	0.15	0.12	0.09	
9	0.34	0.30	0.28	0.26	0.25	0.24	0.22	0.18	0.15	0.12		
10	0.33	0.29	0.27	0.25	0.24	0.23	0.20	0.16	0.15	0.10		
11	0.33	0.29	0.25	0.24	0.23	0.22	0.18	0.15	0.14	0.10		
12	0.32	0.28	0.24	0.23	0.21	0.22	0.17	0.14	0.13	0.08		
13	0.32	0.28	0.23	0.22	0.20	0.20	0.17	0.13	0.10			
14	0.31	0.27	0.22	0.21	0.19	0.19	0.16	0.10				
15	0.31	0.25	0.22	0.21	0.19	0.17	0.14					
16	0.30	0.25	0.20	0.20	0.18	0.16	0.12					
17	0.30	0.24	0.19	0.18	0.17	0.12						
18	0.29	0.22	0.18	0.16	0.15							
19	0.28	0.20	0.17	0.15	0.13							
20	0.27	0.20	0.16	0.15								
21	0.27	0.19	0.15	0.13								
22	0.23	0.18	0.15									
23	0.23	0.17	0.13									
24	0.21	0.16										
25	0.19	0.15										
26	0.17	0.13										
27	0.16											
28	0.16											
29	0.15											
30	0.13											
Profondità del profilo	8.47	6.71	5.7	5.19	4.68	4.17	3.65	2.89	2.38	1.85	1.34	0.98

BSPT 55° – interna ed esterna

Numero di passate	DIMINUIRE LA VELOCITÀ DI TAGLIO PROPORZIONALMENTE ALL'INCREMENTO DELLA PROFONDITA'			
	Profondità del profilo [numero di scanalature/pollice]			
	11	14	19	28
1	0.22	0.19	0.19	0.15
2	0.21	0.18	0.18	0.14
3	0.20	0.17	0.17	0.13
4	0.19	0.16	0.15	0.12
5	0.18	0.15	0.13	0.08
6	0.16	0.14	0.08	
7	0.15	0.12		
8	0.13	0.08		
9	0.08			
Profondità del profilo	1.52	1.19	0.90	0.62

PROFONDITÀ DI PASSATA

ACME 29° – esterna

Numero di passate	DIMINUIRE LA VELOCITÀ DI TAGLIO PROPORZIONALMENTE ALL'INCREMENTO DELLA PROFONDITÀ							
	Profondità del profilo [numero di scanalature/pollice]							
	4	5	6	8	10	12	14	16
1	0.37	0.34	0.32	0.29	0.27	0.25	0.22	0.23
2	0.34	0.32	0.28	0.25	0.23	0.22	0.20	0.21
3	0.30	0.25	0.23	0.21	0.20	0.17	0.18	0.18
4	0.27	0.23	0.21	0.17	0.18	0.14	0.15	0.14
5	0.25	0.22	0.18	0.15	0.14	0.13	0.13	0.12
6	0.24	0.20	0.18	0.13	0.12	0.12	0.11	0.08
7	0.21	0.19	0.16	0.13	0.12	0.10	0.08	
8	0.20	0.19	0.16	0.12	0.11	0.09		
9	0.20	0.18	0.16	0.12	0.11			
10	0.18	0.16	0.15	0.11	0.09			
11	0.17	0.15	0.14	0.11				
12	0.16	0.14	0.13	0.09				
13	0.16	0.13	0.11					
14	0.15	0.11						
15	0.14							
16	0.12							
Profondità del profilo	3.46	2.83	2.41	1.88	1.57	1.22	1.07	0.96

ACME 29° – interna

Numero di passate	DIMINUIRE LA VELOCITÀ DI TAGLIO PROPORZIONALMENTE ALL'INCREMENTO DELLA PROFONDITÀ							
	Profondità del profilo [numero di scanalature/pollice]							
	4	5	6	8	10	12	14	16
1	0.37	0.34	0.32	0.29	0.27	0.25	0.22	0.23
2	0.33	0.31	0.27	0.25	0.23	0.22	0.20	0.21
3	0.30	0.25	0.23	0.21	0.20	0.17	0.18	0.17
4	0.27	0.23	0.20	0.17	0.18	0.15	0.15	0.14
5	0.25	0.22	0.18	0.15	0.15	0.13	0.13	0.12
6	0.23	0.20	0.18	0.14	0.12	0.12	0.11	0.08
7	0.21	0.19	0.16	0.13	0.12	0.10	0.08	
8	0.20	0.19	0.15	0.12	0.11	0.09		
9	0.20	0.17	0.15	0.12	0.11			
10	0.18	0.16	0.15	0.12	0.09			
11	0.17	0.15	0.14	0.11				
12	0.16	0.14	0.13	0.09				
13	0.16	0.13	0.11					
14	0.15	0.11						
15	0.14							
16	0.12							
Profondità del profilo	3.44	2.78	2.38	1.90	1.59	1.23	1.07	0.95

ESECUZIONE DI RECESSI, TRONCATURA E COPIATURA DI TORNITURA

Esecuzione di recessi, troncatura e copiatura.

Pramet offre una gamma completa di utensili per la tornitura di recessi superficiali e profondi, sia radiale che assiale (scanalatura frontale). La tornitura di profilo a copiare/circolare può essere eseguita anche tramite taglio laterale.

Raccomandazione per un utilizzo pratico:

La procedura per tornire un recesso (aumento di profondità e allargamento) è riportata nella seguente illustrazione.

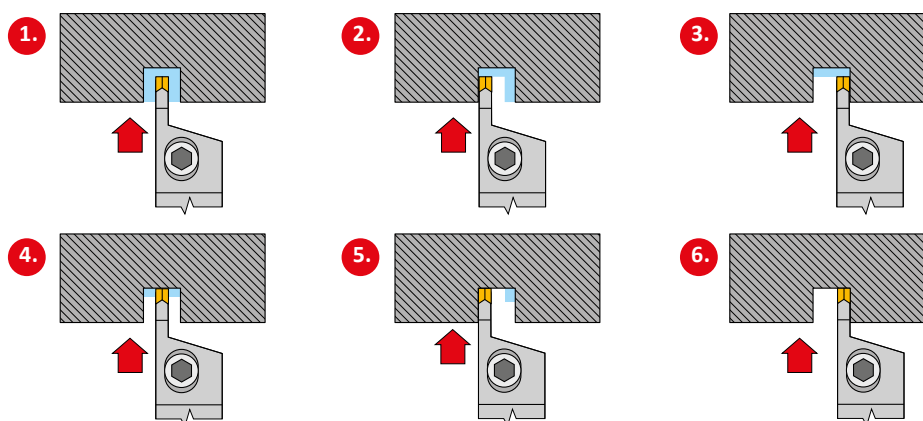

Nota: Per creare una superficie di fondo piana, utilizzare un inserto di tipo **GL** con rompitrucolo **GM** o **LCMF** con rompitrucolo **F**. Le passate di scanalatura radiale esterne dovrebbero sovrapporsi alla passata centrale di due volte il raggio di punta dell'inserto.

Lavorando un recesso largo, seguire la procedura riportata nella seguente illustrazione.

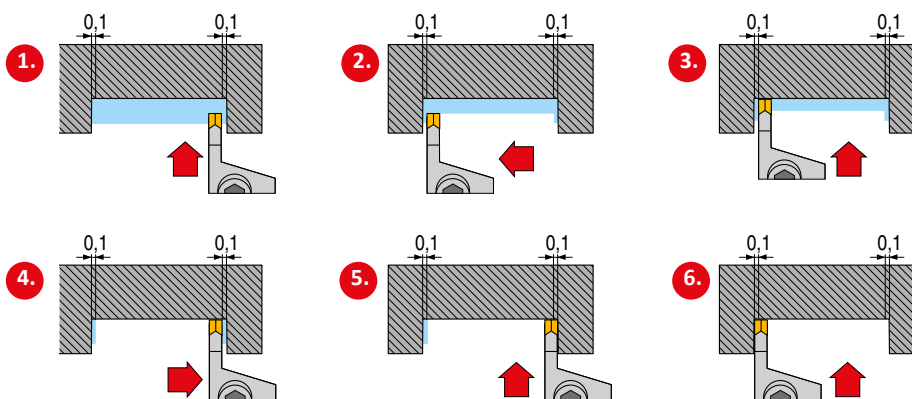

Nota: Utilizzare l'inserto di taglio **LCMF** con rompitrucolo **M**. Bisogna considerare la deformazione utensile "y":

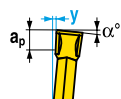

– per $f=0,15$ mm/giro;	$a_p = 3$ mm	$y = 0,07$ mm
– per $f=0,25$ mm/giro;	$a_p = 3$ mm	$y = 0,08$ mm
– per $f=0,35$ mm/giro;	$a_p = 3$ mm	$y = 0,10$ mm

ESECUZIONE DI RECESSI, TRONCATURA E COPIATURA

Quando si apre una scanalatura o se ne aumenta la profondità impiegando la tornitura laterale, utilizzare la procedura riportata nella seguente illustrazione.

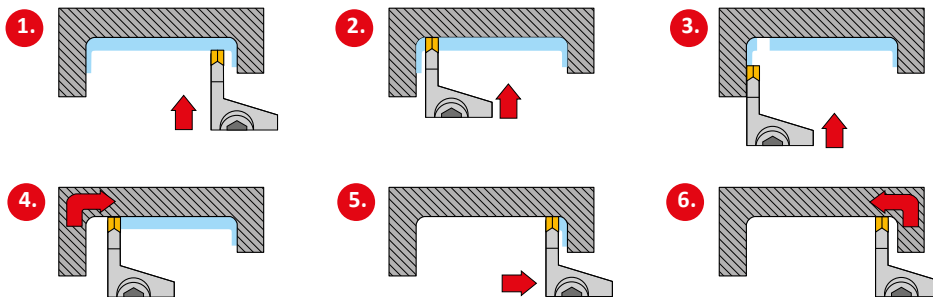

Sgrossatura in copiatura (inserto con tagliente arrotondato)



Finitura in copiatura (inserto con tagliente arrotondato)

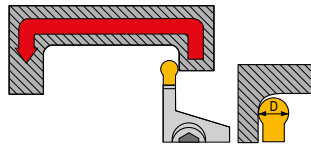

D (mm)	a_p (mm)
3	0.15
4	0.20
5	0.22
6	0.25
8	0.40

ESECUZIONE DI RECESSI, TRONCATURA E COPIATURA

Nell'eseguire la copiatura di tornitura con inserti a fissaggio meccanico con tagliente tondo, la profondità di taglio massima è il 50% del diametro dell'inserto.

Scegliere il portainserito con la massima sezione trasversale e la minima sporgenza per eliminare le vibrazioni.

L'asse longitudinale dell'inserto deve essere perpendicolare all'asse di rotazione del pezzo da lavorare (sui recessi radiali).

Il tagliente deve trovarsi sulla linea centrale entro una tolleranza di ± 0.1 mm

Il refrigerante deve essere applicato direttamente sul tagliente e sull'area di supporto del portainserito sotto il tagliente dell'inserto, in quantità sufficiente per garantire un raffreddamento efficace dell'inserto.

Nell'eseguire la scanalatura frontale è necessario selezionare un portainserito con la serie di diametri corretta per la scanalatura da lavorare. L'utensile deve essere collocato parallelamente all'asse di rotazione del pezzo da lavorare (perpendicolare alla faccia della scanalatura).

In caso contrario, vi è il rischio di sfregamento contro la/le parete(i) della scanalatura durante la lavorazione.

In caso di sfregamento dell'utensile contro la parete esterna della scanalatura, potrebbe essere necessario sollevare il tagliente sopra il centro (vedere esempio A in figura 29).



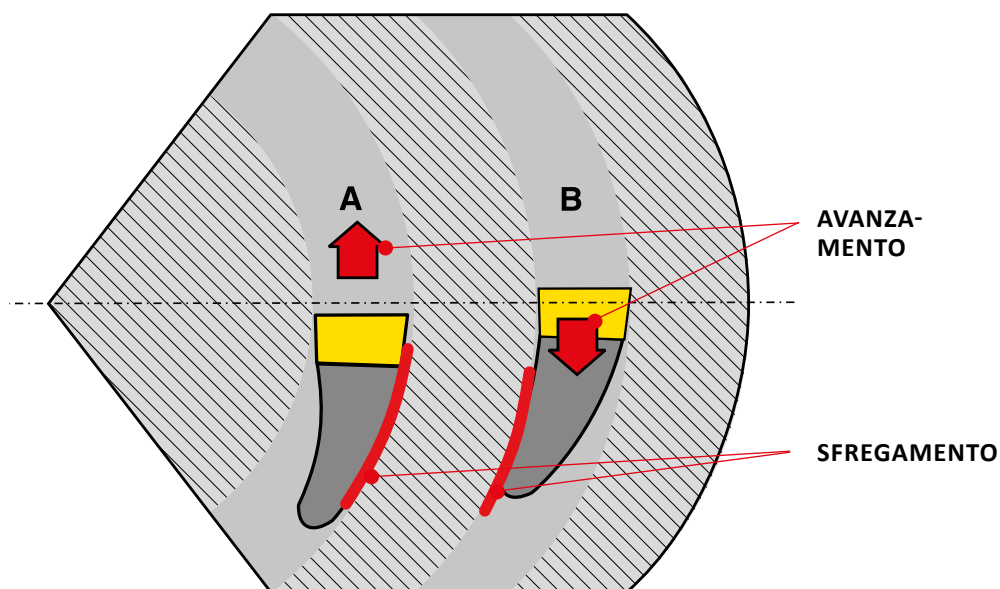





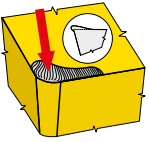

Durante la scanalatura frontale, l'utensile deve essere collocato perpendicolarmente alla faccia del pezzo da lavorare, altrimenti il lato dell'utensile sfregherà contro la scanalatura che si sta creando.

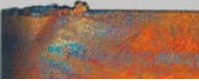







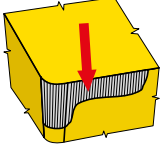
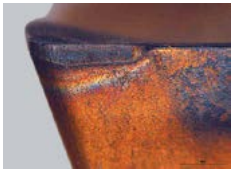

L'utilizzo di un refrigerante efficace, applicato direttamente sul tagliente in quantità sufficiente è molto importante. Il raffreddamento riduce la temperatura del tagliente e anche della parte inferiore del portainserito, in cui è alloggiato l'inserto.

TIPI DI USURA DELL' INSERTO IN TORNITURA







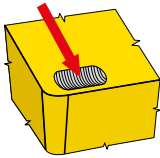
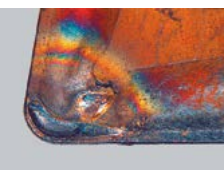

TAGLIANTE DI RIPORTO

  		E' influente	
		++	Fattore decisivo è l'effetto antiadesione
		↑	Più alto è l'avanzamento minori probabilità di effetto anti-adesione
		↓ ↑	Cambiare (generalmente aumentare)
			E' influente
		↓ ↑	Impiegare una geometria più positiva
		-	Usare un refrigerante con maggiori proprietà anti-incollamento

USURA SUL FIANCO







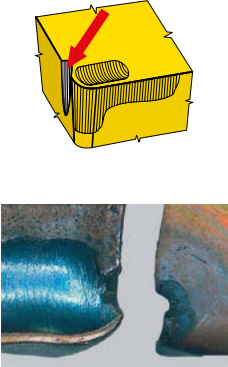

 		↑	Impiegare una qualità con maggiore resistenza all'usura (S)
		++	Il rivestimento è un fattore decisivo - α Al ₂ O ₃)
		↑	l'avanzamento ha influenza nella forma e nella posizione del cratere
		↓	Diminuire la velocità di taglio
		↑	Effetto minimo
		+	Usare una geometria più positiva
		+	Usare il refrigerante o aumentare la portata

CRATERIZZAZIONE









 		↑	Usa una qualità con maggiore resistenza all'usura (S)
		++	Un fattore decisivo è la resistenza termica - α Al ₂ O ₃)
		↑	l'avanzamento ha influenza nella forma e posizione del cratere
		↓	Diminuire la velocità di taglio
		↓	Effetto minimo
		↑	Usare una geometria di taglio più positiva
		++	Impiegare il refrigerante o aumentare la portata

TIPI DI USURA DELL' INSERTO IN TORNITURA







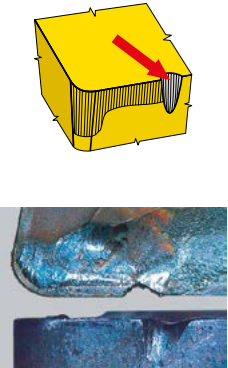

CRATERE DI OSSIDAZIONE SUL TAGLIANTE SECONDARIO

		↑ Usare una qualità più resistente all'usura (H)
		++ Il rivestimento è un fattore decisivo - TiC, TiCN
		↓ Aumentare l'avanzamento (specialmente se è minore di 0.1 mm)
		↓ Diminuire la velocità di taglio
		↓ E' influente
		↑ E' importante aumentare l'angolo di spoglia inferiore
		++ Usa un refrigerante o aumenta la sua portata

DEFORMAZIONE PLASTICA







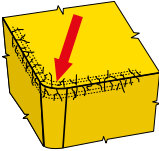

		↑ Usare una qualità più resistente all'usura
		+ Il fattore decisivo è l'attrito basso
		↓ Diminuire l'avanzamento
		↓ Diminuire la velocità di taglio
		↓ Effetto minimo
		↑ Impiegare una geometria più positiva
		++ Impiegare il refrigerante o aumentare la portata

USURA PER INTAGLIO - RIMEDI







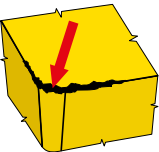

		↑ ↓ Dipende dal tipo di danno (abrasione - usare una qualità più resistente all'usura; rottura - usare un substrato più tenace)
		++ Rivestimento CVD (fattore decisivo è la resistenza all'ossidazione - α Al ₂ O ₃)
		↓ l'avanzamento ha influenza sull'intensità, ma minore rispetto alla velocità di taglio
		↓ Diminuire la velocità di taglio
		↑ ↓ Variare la profondità su diverse passate
		↓ Impiegare geometrie di taglio meno positive
		+ Usare refrigerante o aumentare la portata
		Impiegare utensili con angoli di taglio minori

TIPI DI USURA DELL'INSERTO IN TORNITURA







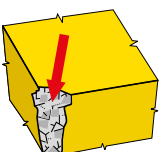

FORMAZIONE DI CRICCHE

 		↓	Il tipo di grana (H) ha un ruolo fondamentale
		++	È consigliato il rivestimento PVD
		↓	l'avanzamento ha influenza sull'intensità, ma minore rispetto alla velocità di taglio
		↓	Bassa velocità significa bassa temperatura
			Non ha alcuna influenza
		↓	Impiegare geometrie meno positive
		- - -	Non usare refrigerante (si può impiegare aria per rimuovere il truciolo)

MICROSCHEGGIATURE NEL TAGLIENTE

 		↓	Il tipo di grana (H) è fondamentale
		+	È consigliato il rivestimento PVD
		↓	È molto importante il controllo del truciolo
		↑ ↓	Influenza controllo del truciolo e vibrazioni
		↓	Riduce il carico (importante per lavorazione con grande sbalzo)
		↓	Impiegare geometrie meno positive
			E' ininfluenza
Lavorare con condizioni migliori, ridurre l'avanzamento nella fase di entrata nel pezzo			

ROTTURA DELL'INSERTO

 		↓	Il tipo di grana (H) è fondamentale
		+	Si consiglia il rivestimento PVD
		↓	Riduce il carico di forze
		↑ ↓	Influenza controllo del truciolo e vibrazioni
		↓	Riduce il carico di forze
		↓	Impiegare geometrie meno positive
			E' ininfluenza
Impiegare condizioni più favorevoli			

TIPI DI USURA DELL' INSERTO IN TORNITURA

CEDIMENTO DEL TAGLIANTE

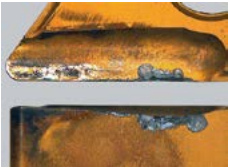
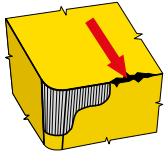

	↓	Il tipo di grana (H) è fondamentale
	+	Si consiglia il rivestimento PVD
	↑ ↓	È importante un buon controllo del truciolo
	↑ ↓	Influenza controllo del truciolo e vibrazioni
	↑ ↓	È importante un buon controllo del truciolo
	↓	Impiegare geometrie meno positive
		E' influente
		Sono problemi il cattivo controllo del truciolo, l'evacuazione e la rimozione

RUGOSITA' INACCETTABILE DELLA SUPERFICIE LAVORATA

Descrizione e cause:

La qualità della superficie lavorata è ovviamente influenzata da molti fattori, fra cui: il materiale del pezzo, l'ambiente di taglio, la realizzazione e lo stato del tagliente, le condizioni di taglio (soprattutto avanzamento e velocità di taglio) e la stabilità del sistema macchina-strumento-pezzo.

- cattiva scelta dell'utensile/inserto
- non corretto spessore del truciolo
- velocità di taglio non corretta
- uso improprio del liquido da taglio
- avanzamento troppo alto

Accorgimenti:

- utilizzare un inserto raschiante o con tratto piano
- utilizzare un inserto con geometria di taglio adatta
- diminuire l'avanzamento
- correggere (per la maggior parte aumentare) la velocità di taglio
- utilizzare il raffreddamento o la lubrificazione (MQL)
- eliminare la vibrazione
- modificare lo spessore del truciolo

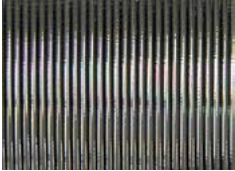

SUPERFICIE VIBRATA (SUPERFICIE NON PIANA A CAUSA DELLE VIBRAZIONI)

Descrizione e cause:

È un fenomeno molto frequente, cause principali sono lo squilibrio del pezzo o dell'utensile, il fissaggio instabile del pezzo e il valore troppo alto delle forze di taglio.

Accorgimenti:

- verificare la stabilità del fissaggio del pezzo
- verificare la stabilità del fissaggio dell'utensile
- diminuire la profondità di taglio
- utilizzare un utensile in buono stato
- correggere (diminuire) la velocità di taglio
- diminuire lo spessore del truciolo
- scegliendo opportunamente la geometria di taglio ed il metallo duro, minimalizzare il bilanciamento delle forze del processo di taglio (più acuto e positivo possibile) cioè utilizzare un utensile con resistenza al taglio più bassa



CREAZIONE DI BAVE

Descrizione e cause:

Questo fenomeno è molto frequente, non si può evitare sempre. La bava sorge soprattutto lavorando acciai teneri e collanti e materiali plastici.

Accorgimenti:

- utilizzare un inserto con tagliente affilato
- utilizzare un inserto con geometria positiva
- utilizzare un angolo del tagliente utensile minore



ERRORI DIMENSIONALI E DI FORMA



Descrizione e cause:

Questi errori sono dovuti a molti fattori o proprietà del sistema macchina-utensile-pezzo.

Accorgimenti:

- scegliere un inserto con resistenza sufficiente all'usura
- riesaminare la stabilità del fissaggio del pezzo
- riesaminare la stabilità del fissaggio dell'utensile

FORMA INADATTA DEL TRUCIOLO



Descrizione e cause:

Forma inadatta del truciolo – è in realtà un criterio ugualmente importante come la durata. La formazione inadatta è influenzata soprattutto dal materiale del pezzo, dall'avanzamento, dalla profondità di taglio e naturalmente dalla scelta opportuna della geometria di taglio. Il truciolo lungo è per molti motivi inaccettabile, ma anche un truciolo troppo corto e forzato può essere indesiderato (testimonia un sovraccarico del tagliente e porta al sorgere di vibrazioni).

Accorgimenti:

- correggere l'avanzamento e la profondità di taglio
- scegliere una geometria più adatta

CONTROLLO DELLO STATO DELLA SEDE DELL'INSERTO

Prima di impiegare un nuovo inserto o di cambiare il tagliente girando l'inserto è necessario pulire la sede, controllare lo stato della sede stessa e di tutto il sistema di bloccaggio inserto.

CONTROLLO E MANUTENZIONE DELLE PARTI DI RICAMBIO

Non meno importante è anche il controllo dei singoli elementi di fissaggio (leve angolari, viti, o cunei di bloccaggio). Per il fissaggio utilizzare parti non danneggiate, in caso di loro sostituzione utilizzare solo i pezzi di ricambio indicati nel catalogo per il dato utensile. Lubrificare regolarmente la filettatura e le superfici di posizionamento delle viti – ad es. con lubrificante resistente alle alte temperature (Molykote G). Per il montaggio e lo smontaggio utilizzare esclusivamente cacciaviti e chiavi indicate nel catalogo o raccomandate dal produttore dell'utensile, inoltre è necessario applicare il giusto tiraggio delle viti (tiraggio proporzionale!) – meglio utilizzare la chiave dinamometrica.

CONTROLLO DEL FISSAGGIO

E' necessario prima di tutto controllare la posizione dell'inserto su tutta la superficie di posizionamento quindi l'appoggio dell'inserto sia in direzione radiale che in direzione assiale. Procedere al bloccaggio dell'inserto.



Materiale lavorato – l'influenza dell'ambiente di taglio aumenta con il peggioramento della lavorabilità del materiale del pezzo da lavorare.

Qualità inserto – l'influenza dell'ambiente di taglio aumenta con l'aumentare della tenacità (contenuto di Co). Il raffreddamento non è consigliato solo per la lavorazione ad alta velocità, ovvero per l'applicazione di CBN e ceramica.

Avanzamento – l'aumento dell'avanzamento aumenta il contributo del fluido di taglio alla vita dell'utensile.

Velocità di taglio (tipica per il materiale lavorato) – maggiore è la velocità di taglio, più importante è l'effetto di raffreddamento del liquido refrigerante e, viceversa, minore è la velocità di taglio, più importante è l'effetto lubrificante del liquido refrigerante.

L'APPORTO di liquido è anche uno dei due criteri che incide fortemente sulla redditività e sulla produttività del processo di taglio. In un caso ideale, il liquido può essere apportato sia alla faccia che al fianco dell'utensile. L'apporto del liquido da taglio dal fianco influisce solo sulla vita dell'utensile. Mentre l'apporto di liquido dalla faccia dell'utensile può in alcuni casi aiutare a formare i trucioli (soprattutto nel caso di raffreddamento ad alta pressione). Se solo una delle alternative è possibile, il tipo di usura indicherà la CORRETTA direzione. Se gli inserti sono usurati sul fianco, cercare di portare il liquido dal basso, cioè sul fianco dell'inserto. Se si forma un cratere, il liquido deve essere diretto verso la faccia dell'utensile (sotto il truciolo, non alla sua radice).

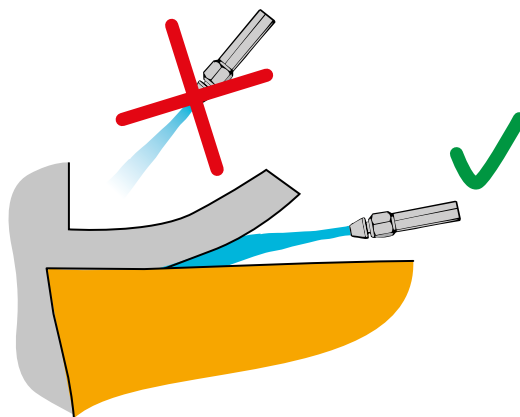

FORMULE PER IL CALCOLO DEI PARAMETRI

Parametro	Formula per il calcolo	Unità	Nota
Numero di giri	$n = \frac{v_c \cdot 1000}{D \cdot \pi}$	(1/min)	n Numero di giri (1/min) D Diametro (dell'utensile o del pezzo) (mm)
Velocità di taglio	$v_c = \frac{\pi \cdot D \cdot n}{1000}$	(m/min)	v_c Velocità di taglio (m/min) f_{rev} Avanzamento al giro (mm/g)
Avanzamento al giro	$f_{rev} = \frac{f_{min}}{n}$	(mm/g)	f_{min} Avanzamento al minuto (avanzamento lineare) (mm/min)
Avanzamento al minuto (velocità di avanzamento)	$f_{min} = v_f = f_{rev} \cdot n$	(mm/min)	
Valore teorico massimo di rugosità della superficie R_{max}	$R_{max} = \frac{125 \cdot f_{rev}^2}{RE}$	(mm)	R_{max} Valore teorico massimo di rugosità della superficie (mm) R_a Rugosità media della superficie fresata (mm)
Rugosità media della superficie R_a	$R_a = \frac{43,9 \cdot f_{rev}^{1,88}}{RE^{0,97}}$	(mm)	f_{rev} Avanzamento al giro (mm/g) RE Raggio inserto (mm)
Sezione del truciolo	$A = f_{rev} \cdot a_p$	(mm ²)	A Sezione del truciolo (mm ²) f_{rev} Avanzamento al giro (mm/g)
Spessore del truciolo (per inserto con tagliente lineare)	$h = f_{rev} \cdot \sin \kappa_r$	(mm)	a_p Profondità di taglio assiale (mm) κ_r Angolo di impostaz. del tagliente utensile (°) h Spessore del truciolo (mm)
Spessore del truciolo (per inserto tondo)	$h = f_{rev} \cdot \sqrt{\frac{a_p}{INSD}}$	(mm)	v_c Velocità di taglio (m/min) f_{min} Avanzamento al minuto (velocità di avanzamento) (mm/min)
Volume di asportazione truciolo	$Q = a_p \cdot f_{rev} \cdot v_c$	(cm ³ /min)	Q Volume di asportazione truciolo (cm ³ /min) $INSD$ Diametro inserto (mm)
Potenza necessaria	$P_c = \frac{a_p \cdot f_{rev}^{1-c} \cdot k_{cl} \cdot v_c \cdot k \kappa_r}{6 \cdot 10^4 \cdot \eta}$	(kW)	P_c Potenza necessaria (kW) a_p Profondità di taglio assiale (mm) f_{rev} Avanzamento (mm/g)
Potenza necessaria approssimativa	$P_c = \frac{a_p \cdot f_{rev} \cdot v_c}{x}$	(kW)	c Costante KTV (1) k_c Forza di taglio specifica (MPa) k_{κ_r} Coefficiente angolo κ_r (1) η Rendimento – solitamente $\eta = 0,75$ (1) x Coefficiente del materiale lavorato (1)

Materiale	Acciaio	Ghisa	Al
Coefficiente x	20	25	100

COPPIE DI SERRAGGIO VITI RACCOMANDATE

VITE DI BLOCCAGGIO		
Designazione della vite	Cacciavite	Coppia (Nm)*
28588	MA2-8304	0.8
28992	MA2-8304	0.8
416.1-832	PT-8002	3.6
5513 020-01	PT-8004	3.6
5513 020-03	PT-8001	0.8
5513 020-04	PT-8003	1.5
5513 020-05	PT-8001	0.8
5513 020-14	TX 225PLUS	8.5
5513 020-24	PT-8002	1.5
5513 020-27	PT-8000	0.6
5513 020-28	PT-8000	0.6
5513 021-03	DMN 3124	13
CS 8601-T09P	SDR T09P	1.7
CS 8601-T15P	SDR T15P	3.9
CS 8601-T20P	SDR T20P	6.4
CS 8601-T25P	SDR T25P	9.5
DVF 0573	PT-8002	1.5
DVF 2260	TX 215PLUS	3.6
DVF 3584	DMD 1650	0.6
DVF 3593	TX 207PLUS	0.8
HS 0408	HXK 3	5
HS 0520C	HXK 4	5
HS 0616C	HXK 5	8
HS 0620	HXK 5	6
HS 0620C	HXK 5	6
HS 0625	HXK 5	6
HS 0625C	HXK 5	6
HS 0630	HXK 5	6
HS 0825	HXK 6	10
HS 0830	HXK 6	10
HS 0835	HXK 6	10
HS 0840	HXK 8	11
HS 1030	HXK 8	8
HS 1060	HXK 6	10
HS 93	HXK 5	8
HS 94	HXK 5	8
HSI 1020	HXK 6	8
PS 0512	HXK 2	2
PS 0512-A	HXK 2	2
PS 0616	HXK 2,5	4
PS 12040	HXK 5	8
PS 6026-709P	SRD T09P	2

VITE DI BLOCCAGGIO		
Designazione della vite	Cacciavite	Coppia (Nm)*
PS 8290	HXK 2	2
SR 14	HXK 10	10
SR 85011-T15P	SDR T15P	5
SR 85017-T09P	SDR T09P	2
SR 85020-T15P	SDR T15P	3
SR 86025-T20P	SRD T20P	5
T20.037	DMD 1650	0.6
UP 0909-T09P	SRD T09P	2
UP 1515-T15P	SDR T15P	8
US 2505-T07P	SDR T07P	0.9
US 2506-T07P	SDR T07P	0.9
US 3007-T09P	SDR T09P	2
US 34	HXK 3	5
US 35	HXK 4	6
US 3508-T15P	SDR T15P	3
US 3510A-T15P	SDR T15P	3
US 3510-T15P	SDR T15P	3
US 3512A-T15P	SDR T15P	3
US 3512-T15P	SDR T15P	3
US 36	HXK 4	6
US 38	HXK 5	8
US 39	HXK 5	8
US 40	HXK 4	6
US 4008-T15P	SDR T15P	3.5
US 4011-T15P	SDR T15P	3.5
US 41	HXK 4	6
US 42	HXK 4	6
US 45013-T20P	SDR T20P	5
US 4512-T15P	SDR T15P	5
US 4514A-T20	SDR T20	5
US 46	HXK 3	5
US 46017-T20P	SDR T20P	5
US 47	HXK 5	8
US 5012-T15P	SDR T15P	5
US 5015-T20P	SDR T20P	5
US 5018-T20P	SDR T20P	5
US 6020-T25P	SDR T25P	6
US 64518-T15P	SDR T15P	5
US 8025-T30P	SDR T20P	13
US 83	HXK 4	6
US 95	HXK 4	10

CACCIAVITI DINAMOMETRICI		
impugnatura intercambiabile	Coppia (Nm)	Filetto della vite di bloccaggio
MR-0.8-2.0 vario	0.5 – 2.0	M 2 – M 3
MR-1.0-5.0 vario	0.8 – 5.0	M 2.5 – M 5
MR-0.9 fix	0.9	M 2
MR-2.0 fix	2.0	M 3
MR-3.0 fix	3.0	M 3.5
MR-3.5 fix	3.5	M 4
MR-5.0 fix	5.0	M 5

IMPUGNATURA INTERCAMBIABILE		
Impugnatura intercambiabile		
D-T6	D-T8	D-T15
D-T6P	D-T8P	D-T15P
D-T7	D-T9	D-T20
D-T7P	D-T9P	D-T20P

LUBRIFICAZIONE DELLE VITI

In considerazione degli alti stress termici è raccomandata una lubrificazione con un grasso resistente alle alte temperature quale il MOLYKOTE 1000.

SET DI BLOCCAGGIO COMPLETO

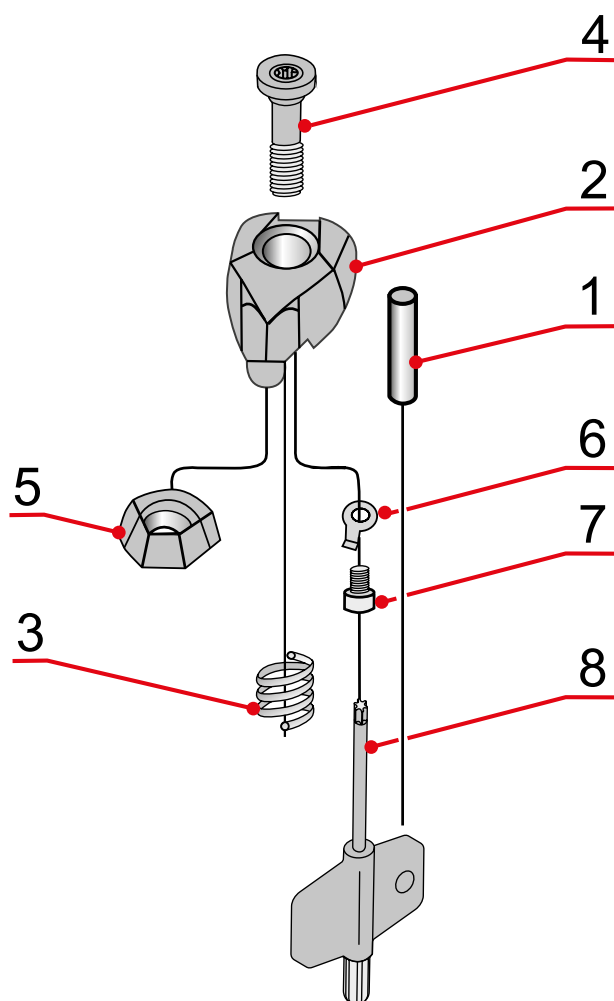

	1	2	3	4		5	6	7	8
									
DCS 09	CP 2655	CD 09	PR 0157	CS 8601-T09P	1.7	-	-	-	-
DCS 12	CP 2607	CD 12	PR 0158	CS 8602-T15P	3.9	-	-	-	-
DCS 16	CP 2607	CD 16	PR 0159	CS 8603-T20P	6.4	-	-	-	-
DCS 19	CP 2607	CD 19	PR 0159	CS 8603-T20P	6.4	-	-	-	-
DCS 25	CP 2607	CD 25	PR 0101	CS 8604-T25P	9.5	-	-	-	-
DCS 16V	CP 2607	CD 16V	PR 0158	CS 8602-T15P	3.9	-	-	-	-
DCS 12C2	CP 2607	CD 12C2	PR 0158	CS 8602-T15P	3.9	PP 3002	H 1201	CS 9701-T07P	FLAG T07P
DCS 16C2	CP 2607	CD 16C2	PR 0159	CS 8603-T20P	6.4	PP 3003	H 1201	CS 9701-T07P	FLAG T07P
DCS 12C4	CP 2607	CD 12C4	PR 0158	CS 8602-T15P	3.9	PP 3002	H 1201	CS 9701-T07P	FLAG T07P
DCS 16C4	CP 2607	CD 16C4	PR 0159	CS 8603-T20P	6.4	PP 3003	H 1201	CS 9701-T07P	FLAG T07P

INFORMAZIONI RIPORTATE NELLE SCATOLE

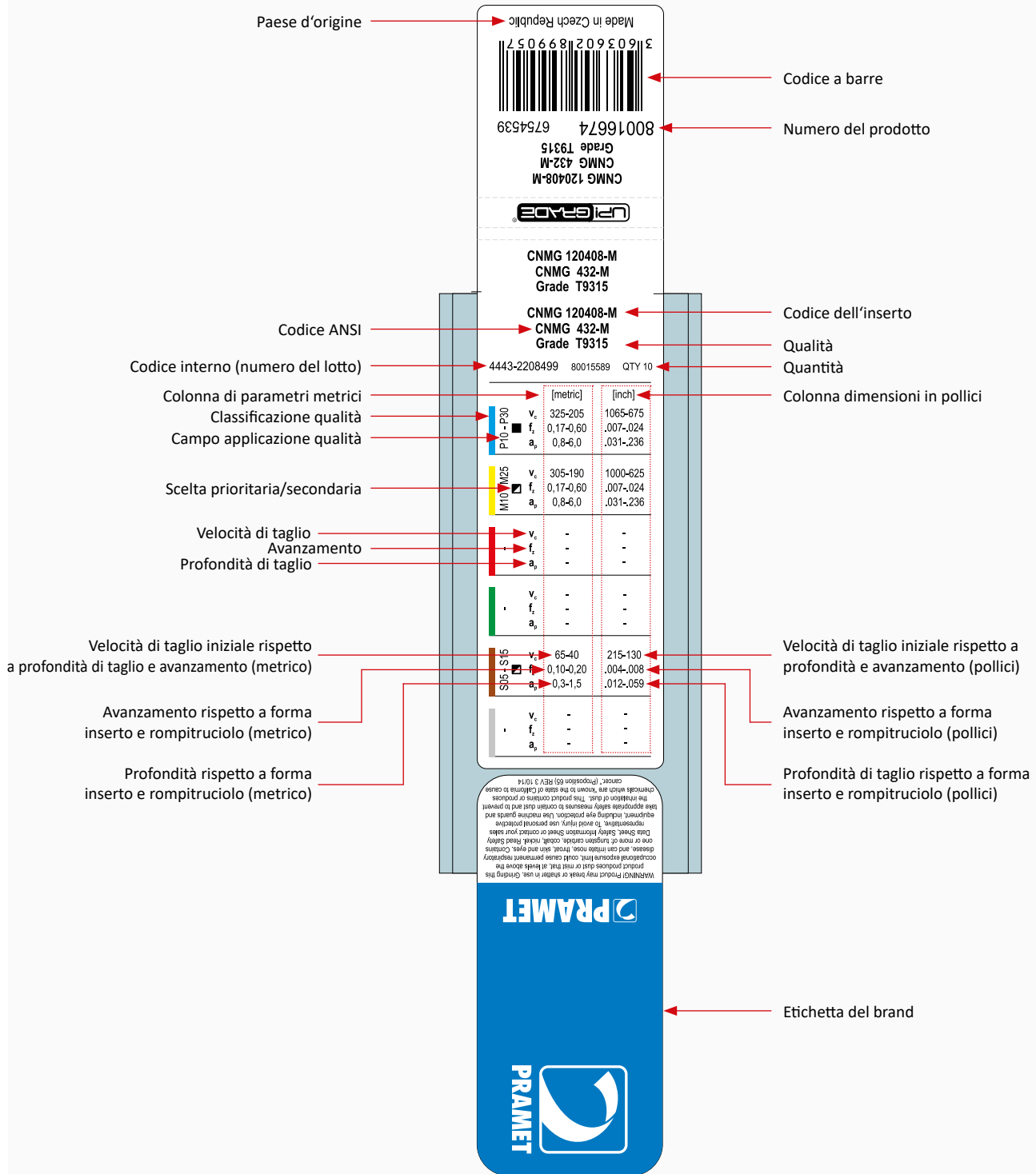

SIMPLY RELIABLE

Un professionista può giudicare la qualità del lavoro grazie ad un semplice esame del truciolo. Il nostro truciolo è pulito e di forma semplice e da solo racchiude in se' una storia.

Il truciolo è il simbolo perfetto del nostro essere.

Simply Reliable.

DORMER PRAMET

Austria

T: +31 10 2080 240
info.at@dormerpramet.com

Belgium & Luxembourg

T: +32 3 440 59 01
info.be@dormerpramet.com

Brazil

T: +55 11 5660 3000
info.br@dormerpramet.com

Canada

T: (888) 336 7637
En Français: (888) 368 8457
cs.canada@dormerpramet.com

China

T: +86 21 2416 0508
info.cn@dormerpramet.com

Croatia

T: +385 98 407 489
info.hr@dormerpramet.com

Czech Republic

T: +420 583 381 111
info.cz@dormerpramet.com

Denmark

T: 808 82106
info.se@dormerpramet.com

Finland

T: 0205 44 7003
info.fi@dormerpramet.com

France

T: +33 (0)2 47 62 57 01
info.fr@dormerpramet.com

Germany

T: +49 9131 933 08 70
info.de@dormerpramet.com

Hungary

T: +36-96 / 522-846
info.hu@dormerpramet.com

India

T: +91 11 4601 5686
info.in@dormerpramet.com

Italy

T: +39 02 30 70 54 44
info.it@dormerpramet.com

Kazakhstan

T: +7 771 305 11 45
info.kz@dormerpramet.com

Mexico

T: +52 (555) 7293981
cs.mexico@dormerpramet.com

Netherlands

T: +31 10 2080 240
info.nl@dormerpramet.com

Norway

T: 800 10 113
info.se@dormerpramet.com

Poland

T: +48 32 78-15-890
info.pl@dormerpramet.com

Portugal

T: +351 21 424 54 21
info.pt@dormerpramet.com

Romania

T: +4(0)730 015 885
info.ro@dormerpramet.com

Russia

T: +7 (495) 775 10 28
info.ru@dormerpramet.com

Slovakia

T: +421 (41) 764 54 60
info.sk@dormerpramet.com

Slovenia

T: +385 98 407 489
info.si@dormerpramet.com

Spain

T: +34 935717722
info.es@dormerpramet.com

Sweden

responsible for Iceland
T: +46 35 16 52 96
info.se@dormerpramet.com

Switzerland

T: +31 10 2080 240
info.ch@dormerpramet.com

Turkey

T: +90 533 212 45 47
info.tr@dormerpramet.com

Ukraine

T: +38 067 566 38 80
T: +38 067 566 81 51
info.ua@dormerpramet.com

United Kingdom

responsible for Ireland
T: 0870 850 4466
info.uk@dormerpramet.com

United States of America

T: (800) 877-3745
cs@dormerpramet.com

Other countries

South America

T: +55 11 5660 3000
info.br@dormerpramet.com

Adria

T: +420 583 381 527
info.rcee@dormerpramet.com

Rest of the World

Dormer Pramet International UK
T: +44 1246 571338
info.int@dormerpramet.com

Dormer Pramet International CZ
T: +420 583 381 520
info.int.cz@dormerpramet.com

DP-CAT-TURNING-2021-IT

FOLLOW US...



www.dormerpramet.com



youtube.com/dormerpramet



facebook.com/dormerprametsocial



linkedin.com/company/dormerpramet



instagram.com/dormerprametsocial



twitter.com/dormerpramet